

*RoHS COMPLIANT

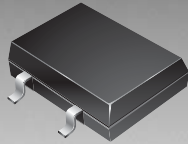

BOURNS®

Features

- RoHS compliant*
- Small SMT package
- High reliability with superior moisture resistance
- Applicable to automatic insertion



This series is currently available but not recommended for new designs.

Applications

- Switching power supply
- Home appliances, office equipment
- Telecommunication, factory automation

CDNBS04-B08200~B08800 Surface Mount Rectifier

General Information

The CDNBS04-B08200~B08800 device provides Bridge Rectification with high reliability with superior moisture resistance for home appliances, office equipment and telecommunications.

The device provide 0.8 A rectification with a choice of repetitive peak reverse voltages from 200 V to 800 V. The device measures 5 mm x 7 mm and is available in a four lead SMT package intended to be mounted directly onto an FR4 printed circuit board.

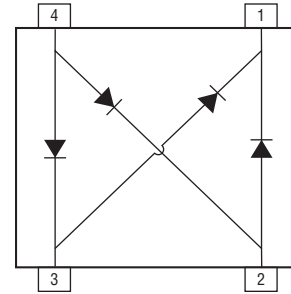

Electrical Characteristics (@ $T_A = 25\text{ }^\circ\text{C}$ Unless Otherwise Noted)

Parameter	Symbol	CDNBS04-				Unit
		B08200	B08400	B08600	B08800	
Maximum Repetitive Peak Reverse Voltage	V_{RRM}	200	400	600	800	V
Maximum RMS Voltage	V_{RMS}	140	280	420	560	V
Maximum DC Blocking Voltage	V_{DC}	200	400	600	800	V
Maximum Average Forward Rectified Current @ $T_A = 40\text{ }^\circ\text{C}$ ¹	$I_{(AV)}$	0.8				A
Maximum DC Reverse Current @ $T_J = 25\text{ }^\circ\text{C}$	I_R	5				μA
Maximum DC Reverse Current @ $T_J = 100\text{ }^\circ\text{C}$	I_R	100				μA
Maximum Forward Voltage @ 0.4 A DC	V_F	1.15				V
I^2t Rating for Fusing ($T < 8\text{ ms}$)	I^2t	3.7				A^2S
Maximum Recovery Time	T_{RR}	150		200	500	ns
Typical Thermal Resistance ²	$R_{\theta JA}$	50				$^\circ\text{C}/\text{W}$
Typical Junction Capacitance per element ³	C_J	13				pF
Peak forward surge current 8.3 ms single half sine-wave superimposed on rated load (JEDEC Method)	I_{FSM}	30				A

Notes:

- 1 Mounted on PC Board. See Forward Derating Curve.
- 2 Thermal Resistance from Junction to Ambient.
- 3 Measured at 1 MHz and applied Reverse Voltage of 4.0 VDC.

Thermal Characteristics (@ $T_A = 25\text{ }^\circ\text{C}$ Unless Otherwise Noted)

Parameter	Symbol	CDNBS04-B08200~B08800	Unit
Operating Temperature Range	T_J	-55 to +150	$^\circ\text{C}$
Storage Temperature Range	T_{STG}	-55 to +150	$^\circ\text{C}$

*RoHS Directive 2002/95/EC Jan 27, 2003 including Annex.
 Specifications are subject to change without notice.
 Customers should verify actual device performance in their specific applications.

CDNBS04-B08200~B08800 Surface Mount Rectifier



Product Dimensions

This is a molded package weighs approximately 0.125 g and can be mounted in any position. The dimensions for the packaged device are shown below.

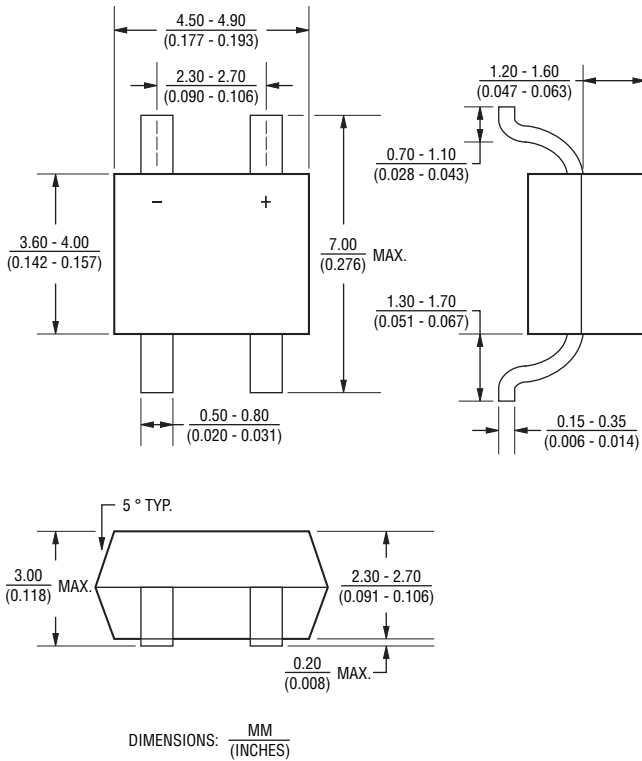

Block Diagram

The block diagram below includes the pin names and basic electrical connections associated with each channel.

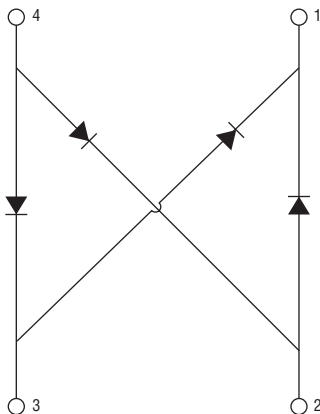

Recommended Footprint

The device will mount onto existing JEDEC SOD-106 footprint.

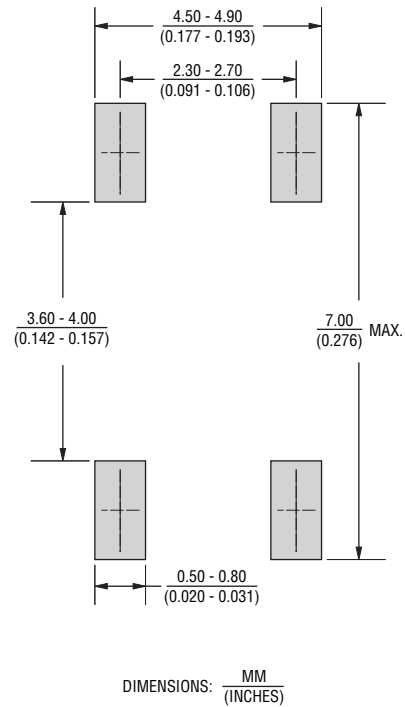

How To Order

Common Code CD NBS04 - B 08 800

CD = Chip Diode

Package NBS04

Model Series B
B = Bridge Rectifier

Maximum Rectified Current 08
08 = 100 mA

Working Peak Reverse Voltage 800
200 = 200 V_{RWM}
400 = 400 V_{RWM}
600 = 600 V_{RWM}
800 = 800 V_{RWM}

Typical Part Marking

CDNBS04-B08200 **B 8 200**

CDNBS04-B08400 **B 8 400**

CDNBS04-B08600 **B 8 600**

CDNBS04-B08800 **B 8 800**

CDNBS04-B08200~B08800 Surface Mount Rectifier

BOURNS®

Packaging Specifications

The product will be dispensed in Tape and Reel format (see diagram below).

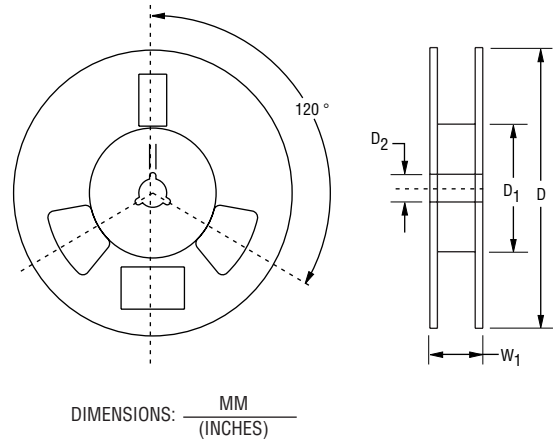
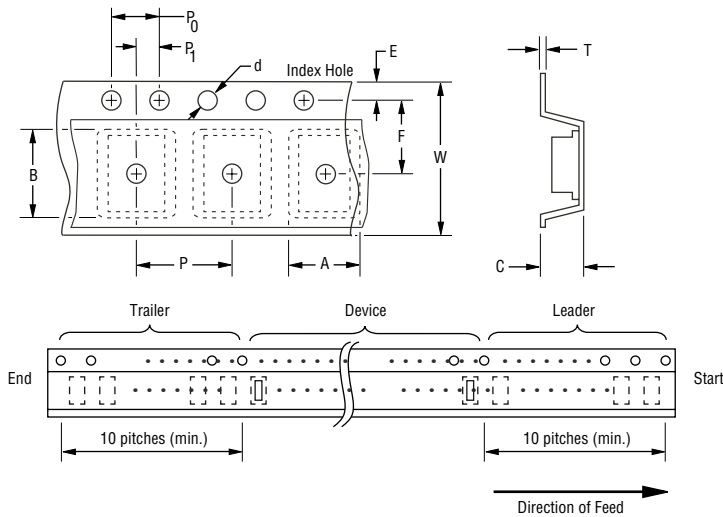

Devices are packed in accordance with EIA standard RS-481-A.

Item	Symbol	NSOIC 4L
Carrier Width	A	$\frac{6.7 \pm 0.10}{(0.264 \pm 0.004)}$
Carrier Length	B	$\frac{5.5 \pm 0.10}{0.217 \pm 0.004}$
Carrier Depth	C	$\frac{2.10 \pm 0.10}{0.083 \pm 0.004}$
Sprocket Hole	d	$\frac{1.55 \pm 0.05}{(0.061 \pm 0.002)}$
Reel Outside Diameter	D	$\frac{330}{(12.992)}$
Reel Inner Diameter	D ₁	$\frac{80.0}{(3.1500)}$ MIN.
Feed Hole Diameter	D ₂	$\frac{13.0 \pm 0.20}{(0.512 \pm 0.008)}$
Sprocket Hole Position	E	$\frac{1.75 \pm 0.10}{(0.069 \pm 0.004)}$
Punch Hole Position	F	$\frac{3.50 \pm 0.05}{(0.138 \pm 0.002)}$
Punch Hole Pitch	P	$\frac{8.00 \pm 0.10}{(0.315 \pm 0.004)}$
Sprocket Hole Pitch	P ₀	$\frac{4.00 \pm 0.10}{(0.157 \pm 0.004)}$
Embossment Center	P ₁	$\frac{2.00 \pm 0.05}{(0.079 \pm 0.002)}$
Overall Tape Thickness	T	$\frac{0.20 \pm 0.10}{(0.008 \pm 0.004)}$
Tape Width	W	$\frac{12.00 \pm 0.20}{(0.472 \pm 0.008)}$
Reel Width	W ₁	$\frac{18.4}{(0.724)}$ MAX.
Quantity per Reel	-	2500

Specifications are subject to change without notice.
Customers should verify actual device performance in their specific applications.

Performance Graphs

Forward Current Derating Curve

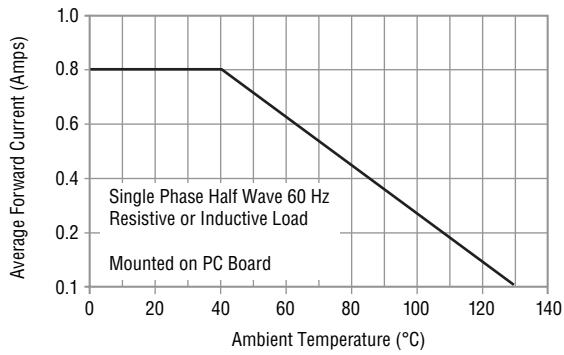

Maximum Non-Repetitive Surge Current

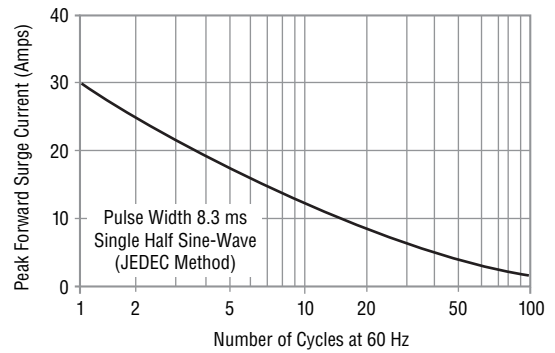

Typical Forward Characteristics

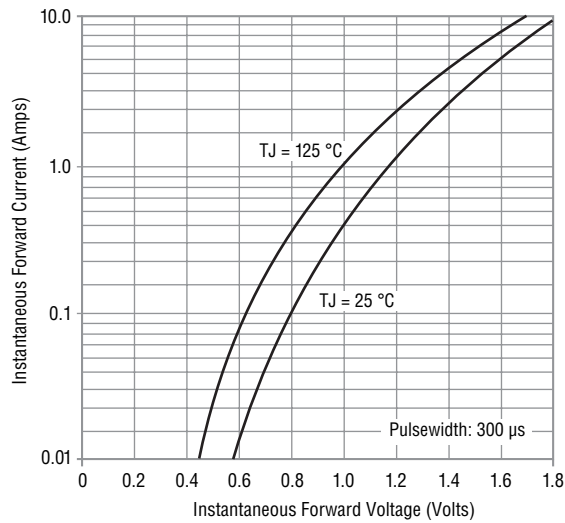

Typical Reverse Characteristics

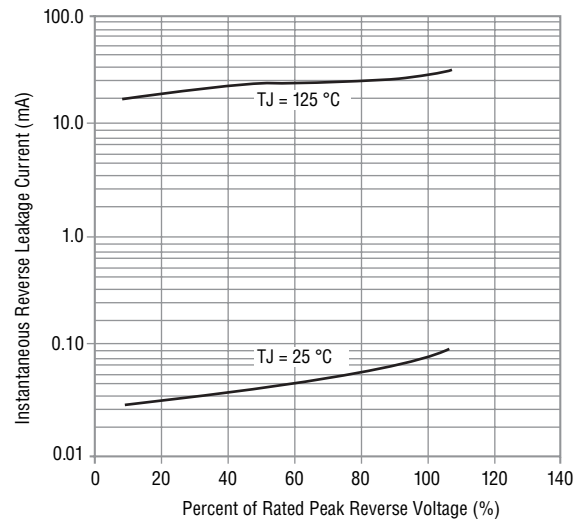

Typical Junction Capacitance

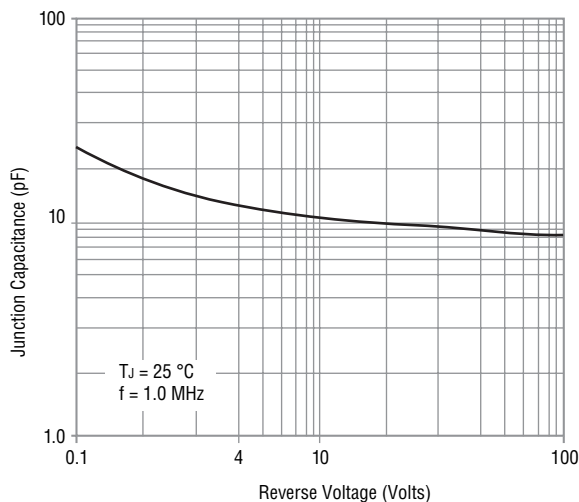

BOURNS®

Asia-Pacific:

Tel: +886-2 2562-4117 • Fax: +886-2 2562-4116

Europe:

Tel: +41-41 768 5555 • Fax: +41-41 768 5510

The Americas:

Tel: +1-951 781-5500 • Fax: +1-951 781-5700

www.bourns.com