

# Converter - Brake - Inverter Module (CBI2)

NPT<sup>3</sup>-IGBT

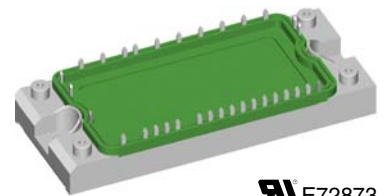
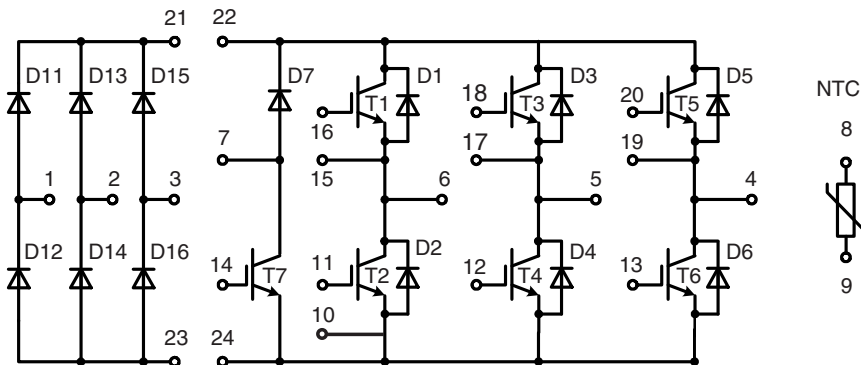

**E72873**

See outline drawing for pin arrangement

Three Phase Rectifier	Brake Chopper	Three Phase Inverter
$V_{RRM} = 1600 \text{ V}$	$V_{CES} = 1200 \text{ V}$	$V_{CES} = 1200 \text{ V}$
$I_{FAVM} = 42 \text{ A}$	$I_{C25} = 35 \text{ A}$	$I_{C25} = 52 \text{ A}$
$I_{FSM} = 300 \text{ A}$	$V_{CE(sat)} = 2.3 \text{ V}$	$V_{CE(sat)} = 2.2 \text{ V}$

**Input Rectifier Bridge D11 - D16**

Symbol	Conditions	Maximum Ratings	
$V_{RRM}$		1600	V
$I_{FAV}$	$T_C = 80^\circ\text{C}$ ; sine 180°	30	A
$I_{DAVM}$	$T_C = 80^\circ\text{C}$ ; rectangular; $d = 1/3$ , bridge	80	A
$I_{FSM}$	$T_{VJ} = 25^\circ\text{C}$ ; $t = 10 \text{ ms}$ ; sine 50 Hz	300	A
$P_{tot}$	$T_C = 25^\circ\text{C}$	100	W

**Application: AC motor drives with**

- Input from single or three phase grid
- Three phase synchronous or asynchronous motor
- electric braking operation

**Features**

- High level of integration - only one power semiconductor module required for the whole drive
- Inverter with NPT<sup>3</sup> IGBTs
  - low saturation voltage
  - positive temperature coefficient
  - fast switching
  - short tail current
- Epitaxial free wheeling diodes with Hiperfast and soft reverse recovery
- Industry standard package with insulated copper base plate and soldering pins for PCB mounting
- Temperature sense included

Symbol	Conditions	Characteristic Values ( $T_{VJ} = 25^\circ\text{C}$ , unless otherwise specified)		
		min.	typ.	max.
$V_F$	$I_F = 35 \text{ A}$ ; $T_{VJ} = 25^\circ\text{C}$ $T_{VJ} = 125^\circ\text{C}$		1.2 1.2	1.4 V V
$I_R$	$V_R = V_{RRM}$ ; $T_{VJ} = 25^\circ\text{C}$ $T_{VJ} = 125^\circ\text{C}$		0.4	0.02 mA mA
$R_{thJC}$	(per diode)			1.3 K/W

**Output Inverter T1 - T6**

Symbol	Conditions	Maximum Ratings	
$V_{CES}$	$T_{VJ} = 25^{\circ}\text{C}$ to $150^{\circ}\text{C}$	1200	V
$V_{GES}$	Continuous	$\pm 20$	V
$I_{C25}$	$T_C = 25^{\circ}\text{C}$	52	A
$I_{C80}$	$T_C = 80^{\circ}\text{C}$	36	A
$I_{CM}$ $V_{CEK}$	RBSOA; $V_{GE} = \pm 15\text{ V}$ ; $R_G = 39\ \Omega$ ; $T_{VJ} = 125^{\circ}\text{C}$ Clamped inductive load; $L = 100\ \mu\text{H}$	70 $V_{CES}$	A
$t_{SC}$ (SCSOA)	$V_{CE} = 900\text{ V}$ ; $V_{GE} = \pm 15\text{ V}$ ; $R_G = 39\ \Omega$ ; $T_{VJ} = 125^{\circ}\text{C}$ non-repetitive	10	$\mu\text{s}$
$P_{tot}$	$T_C = 25^{\circ}\text{C}$	225	W

Symbol	Conditions	Characteristic Values ( $T_{VJ} = 25^{\circ}\text{C}$ , unless otherwise specified)		
		min.	typ.	max.
$V_{CE(sat)}$	$I_C = 35\text{ A}$ ; $V_{GE} = 15\text{ V}$ ; $T_{VJ} = 25^{\circ}\text{C}$ $T_{VJ} = 125^{\circ}\text{C}$		2.2 2.5	2.8 V
$V_{GE(th)}$	$I_C = 1\text{ mA}$ ; $V_{GE} = V_{CE}$	4.5		6.5 V
$I_{CES}$	$V_{CE} = V_{CES}$ ; $V_{GE} = 0\text{ V}$ ; $T_{VJ} = 25^{\circ}\text{C}$ $T_{VJ} = 125^{\circ}\text{C}$		0.4	0.4 mA mA
$I_{GES}$	$V_{CE} = 0\text{ V}$ ; $V_{GE} = \pm 20\text{ V}$			200 nA
$t_{d(on)}$ $t_r$ $t_{d(off)}$ $t_f$ $E_{on}$ $E_{off}$	Inductive load, $T_{VJ} = 125^{\circ}\text{C}$ $V_{CE} = 600\text{ V}$ ; $I_C = 35\text{ A}$ $V_{GE} = \pm 15\text{ V}$ ; $R_G = 39\ \Omega$		85	ns
			50	ns
			440	ns
			50	ns
			5.4	mJ
			2.6	mJ
$C_{ies}$	$V_{CE} = 25\text{ V}$ ; $V_{GE} = 0\text{ V}$ ; $f = 1\text{ MHz}$		2	nF
$Q_{Gon}$	$V_{CE} = 600\text{ V}$ ; $V_{GE} = 15\text{ V}$ ; $I_C = 35\text{ A}$		150	nC
$R_{thJC}$	(per IGBT)			0.55 K/W

**Output Inverter D1 - D6**

Symbol	Conditions	Maximum Ratings	
$I_{F25}$	$T_C = 25^{\circ}\text{C}$	50	A
$I_{F80}$	$T_C = 80^{\circ}\text{C}$	33	A

Symbol	Conditions	Characteristic Values		
		min.	typ.	max.
$V_F$	$I_F = 35\text{ A}$ ; $V_{GE} = 0\text{ V}$ ; $T_{VJ} = 25^{\circ}\text{C}$ $T_{VJ} = 125^{\circ}\text{C}$		1.8	2.8 V V
$I_{RM}$ $t_{rr}$ $E_{rec(off)}$	$I_F = 30\text{ A}$ ; $di_F/dt = -1100\text{ A}/\mu\text{s}$ ; $T_{VJ} = 125^{\circ}\text{C}$ $V_R = 600\text{ V}$ ; $V_{GE} = 0\text{ V}$		51	A
			180	ns
			1.8	mJ
$R_{thJC}$	(per diode)			1.19 K/W

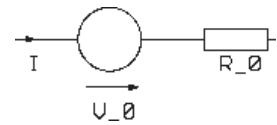
**Equivalent Circuits for Simulation**
**Conduction**

**D11 - D16**

 Rectifier Diode (typ. at  $T_J = 125^{\circ}\text{C}$ )  
 $V_o = 0.83\text{ V}$ ;  $R_o = 11\text{ m}\Omega$ 
**T1 - T6 / D1 - D6**

 IGBT (typ. at  $V_{GE} = 15\text{ V}$ ;  $T_J = 125^{\circ}\text{C}$ )  
 $V_o = 0.95\text{ V}$ ;  $R_o = 45\text{ m}\Omega$ 

 Free Wheeling Diode (typ. at  $T_J = 125^{\circ}\text{C}$ )  
 $V_o = 1.26\text{ V}$ ;  $R_o = 15\text{ m}\Omega$ 
**T7 / D7**

 IGBT (typ. at  $V_{GE} = 15\text{ V}$ ;  $T_J = 125^{\circ}\text{C}$ )  
 $V_o = 1.37\text{ V}$ ;  $R_o = 62\text{ m}\Omega$ 

 Free Wheeling Diode (typ. at  $T_J = 125^{\circ}\text{C}$ )  
 $V_o = 1.39\text{ V}$ ;  $R_o = 56\text{ m}\Omega$

**Brake Chopper T7**

Symbol	Conditions	Maximum Ratings	
$V_{CES}$	$T_{VJ} = 25^{\circ}\text{C}$ to $150^{\circ}\text{C}$	1200	V
$V_{GES}$	Continuous	$\pm 20$	V
$V_{GEM}$	Transient	$\pm 30$	V
$I_{C25}$	$T_C = 25^{\circ}\text{C}$	35	A
$I_{C80}$	$T_C = 80^{\circ}\text{C}$	25	A
$I_{CM}$ $V_{CEK}$	RBSOA; $V_{GE} = \pm 15\text{ V}$ ; $R_G = 82\ \Omega$ ; $T_{VJ} = 125^{\circ}\text{C}$ Clamped inductive load; $L = 100\ \mu\text{H}$	35 $V_{CES}$	A
$t_{SC}$ (SCSOA)	$V_{CE} = V_{CES}$ ; $V_{GE} = \pm 15\text{ V}$ ; $R_G = 82\ \Omega$ ; $T_{VJ} = 125^{\circ}\text{C}$ non-repetitive	10	$\mu\text{s}$
$P_{tot}$	$T_C = 25^{\circ}\text{C}$	180	W

Symbol	Conditions	Characteristic Values ( $T_{VJ} = 25^{\circ}\text{C}$ , unless otherwise specified)		
		min.	typ.	max.
$V_{CE(sat)}$	$I_C = 20\text{ A}$ ; $V_{GE} = 15\text{ V}$ ; $T_{VJ} = 25^{\circ}\text{C}$ $T_{VJ} = 125^{\circ}\text{C}$		2.3 2.6	3 V V
$V_{GE(th)}$	$I_C = 0.6\text{ mA}$ ; $V_{GE} = V_{CE}$	4.5		6.5 V
$I_{CES}$	$V_{CE} = V_{CES}$ ; $V_{GE} = 0\text{ V}$ ; $T_{VJ} = 25^{\circ}\text{C}$ $T_{VJ} = 125^{\circ}\text{C}$		0.8	0.8 mA mA
$I_{GES}$	$V_{CE} = 0\text{ V}$ ; $V_{GE} = \pm 20\text{ V}$			200 nA
$t_{d(on)}$ $t_r$ $t_{d(off)}$ $t_f$ $E_{off}$	Inductive load, $T_{VJ} = 125^{\circ}\text{C}$ $V_{CE} = 600\text{ V}$ ; $I_C = 20\text{ A}$ $V_{GE} = \pm 15\text{ V}$ ; $R_G = 82\ \Omega$		100	ns
			75	ns
			500	ns
			70	ns
			2.4	mJ
$C_{ies}$	$V_{CE} = 25\text{ V}$ ; $V_{GE} = 0\text{ V}$ ; $f = 1\text{ MHz}$		1000	pF
$Q_{Gon}$	$V_{CE} = 600\text{ V}$ ; $V_{GE} = 15\text{ V}$ ; $I_C = 20\text{ A}$		70	nC
$R_{thJC}$				0.7 K/W

**Brake Chopper D7**

Symbol	Conditions	Maximum Ratings	
$V_{RRM}$	$T_{VJ} = 25^{\circ}\text{C}$ to $150^{\circ}\text{C}$	1200	V
$I_{F25}$	$T_C = 25^{\circ}\text{C}$	16	A
$I_{F80}$	$T_C = 80^{\circ}\text{C}$	11	A

Symbol	Conditions	Characteristic Values		
		min.	typ.	max.
$V_F$	$I_F = 20\text{ A}$ ; $T_{VJ} = 25^{\circ}\text{C}$ $T_{VJ} = 125^{\circ}\text{C}$		2.6	3.6 V V
$I_R$	$V_R = V_{RRM}$ ; $T_{VJ} = 25^{\circ}\text{C}$ $T_{VJ} = 125^{\circ}\text{C}$		0.07	0.06 mA mA
$I_{RM}$ $t_{tr}$	$I_F = 20\text{ A}$ ; $di_F/dt = -400\text{ A}/\mu\text{s}$ ; $T_{VJ} = 125^{\circ}\text{C}$ $V_R = 600\text{ V}$		13	A
			110	ns
$R_{thJC}$				3.2 K/W

## Temperature Sensor NTC

Symbol	Conditions	Characteristic Values		
		min.	typ.	max.
$R_{25}$	T = 25°C	4.75	5.0	5.25 kΩ
$B_{25/50}$			3375	K

## Module

Symbol	Conditions	Maximum Ratings	
$T_{VJ}$		-40...+125	°C
$T_{JM}$		150	°C
$T_{stg}$		-40...+125	°C
$V_{ISOL}$	$I_{ISOL} = 1 \text{ mA}; 50/60 \text{ Hz}$	2500	V~
$M_d$	Mounting torque (M5)	2.7 - 3.3	Nm

Symbol	Conditions	Characteristic Values		
		min.	typ.	max.
$R_{pin-chip}$			5	mΩ
$d_s$	Creepage distance on surface	6		mm
$d_A$	Strike distance in air	6		mm
$R_{thCH}$	with heatsink compound		0.02	K/W
Weight			180	g

Dimensions in mm (1 mm = 0.0394")

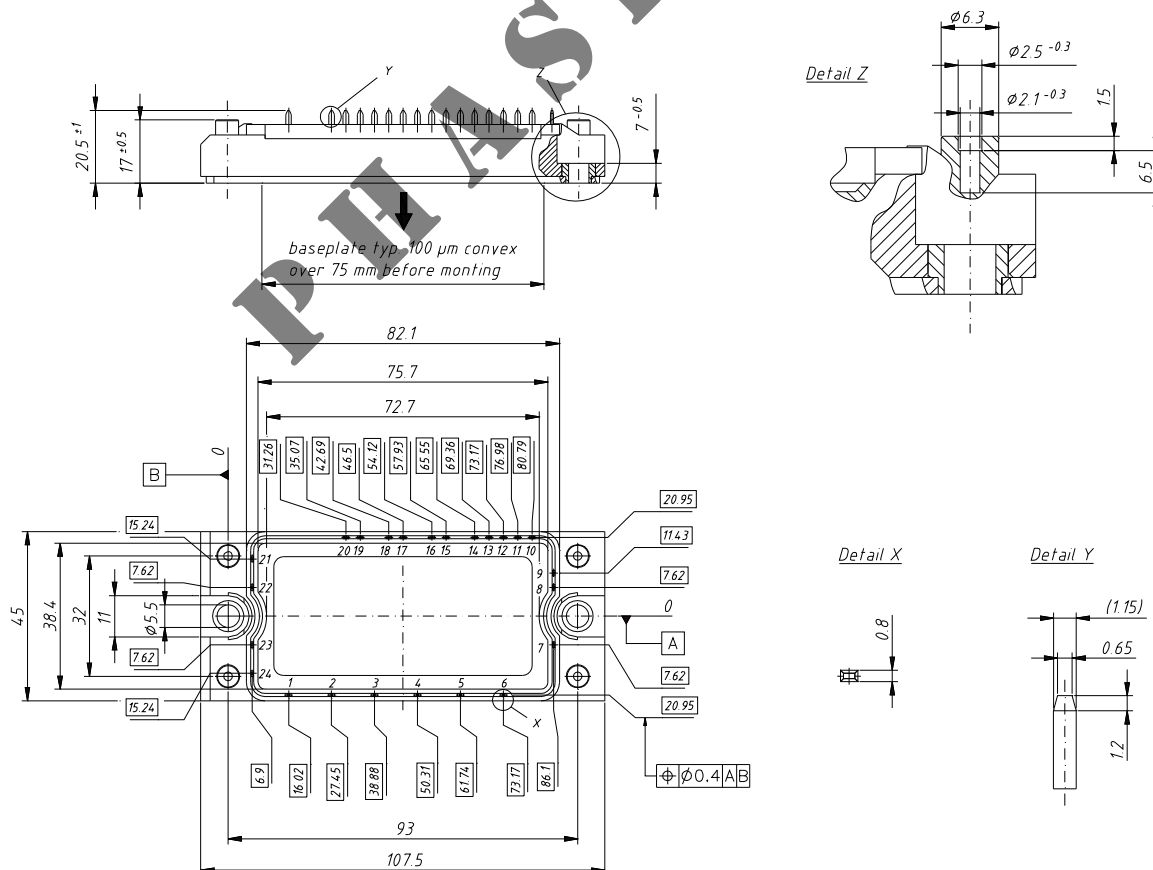

**Input Rectifier Bridge D11 - D16**

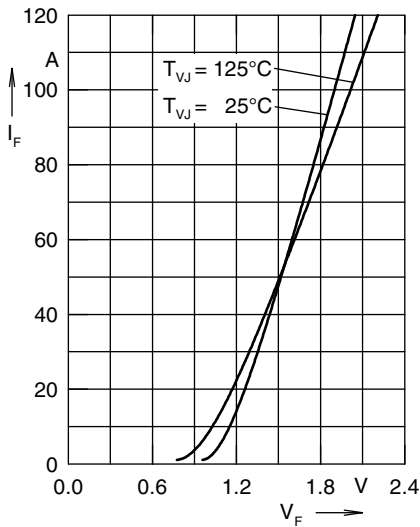

Fig. 1 Forward current versus voltage drop per diode

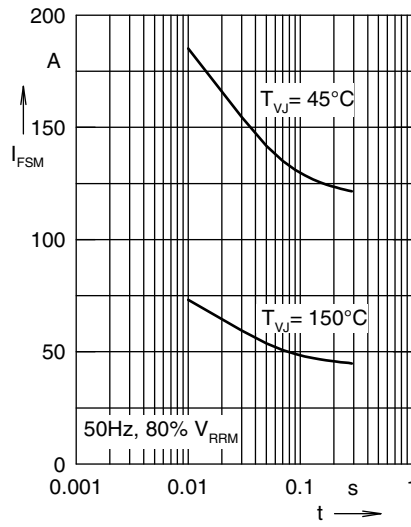

Fig. 2 Surge overload current

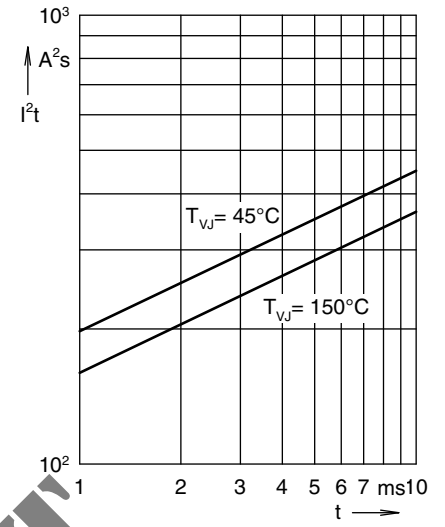

Fig. 3  $I^2t$  versus time per diode

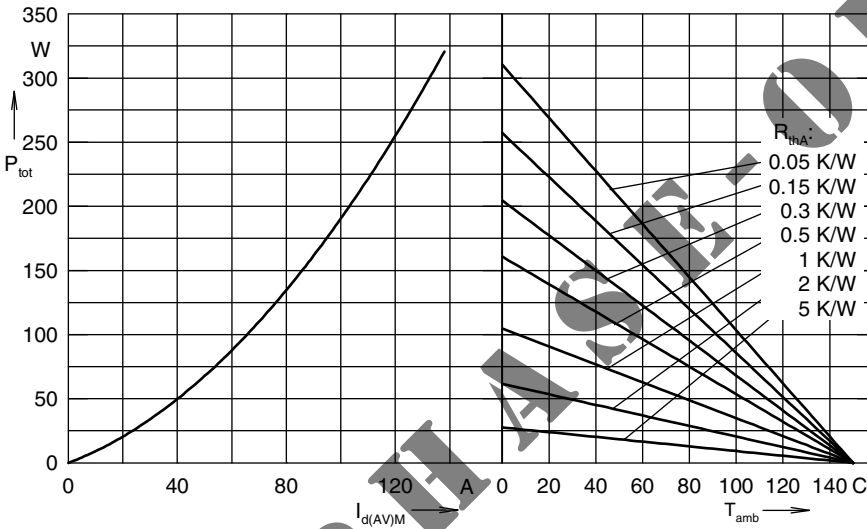

Fig. 4 Power dissipation versus direct output current and ambient temperature, sin 180°

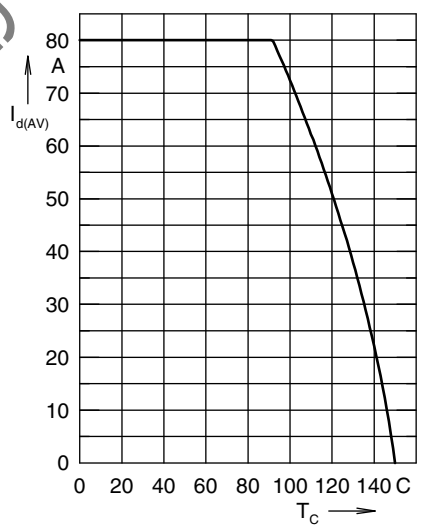

Fig. 5 Max. forward current versus case temperature

**Output Inverter T1 - T6 / D1 - D6**

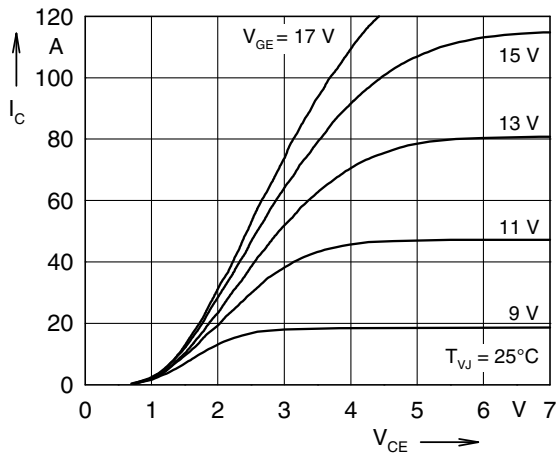

Fig. 7 Typ. output characteristics

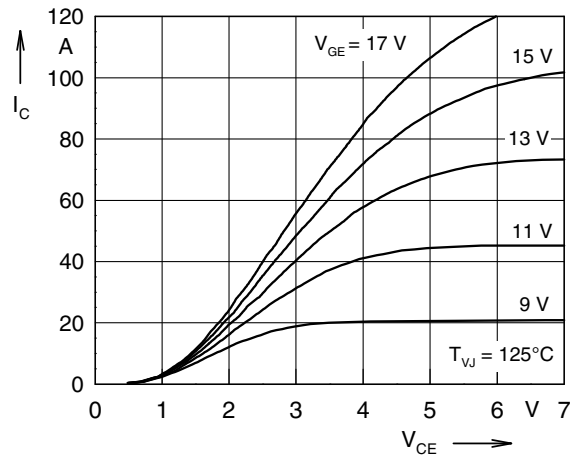

Fig. 8 Typ. output characteristics

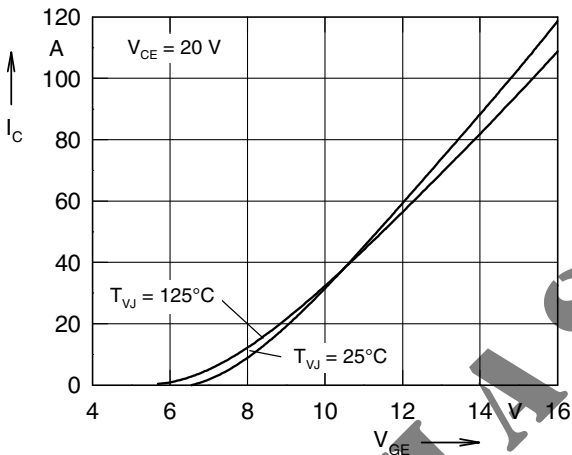

Fig. 9 Typ. transfer characteristics

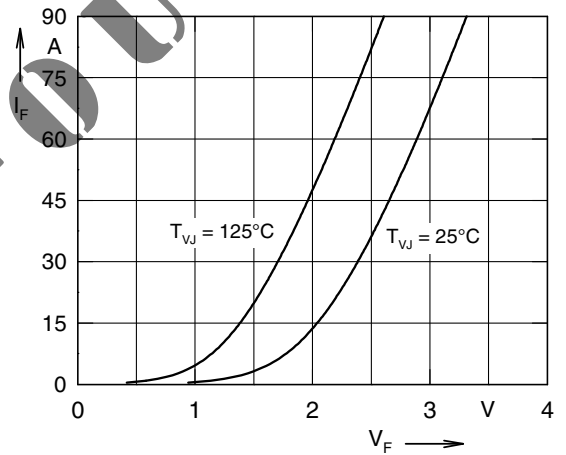

Fig. 10 Typ. forward characteristics of free wheeling diode

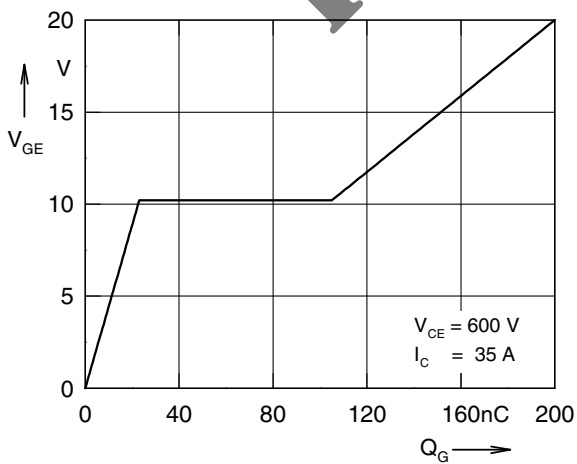

Fig. 11 Typ. turn on gate charge

**Output Inverter T1 - T6 / D1 - D6**

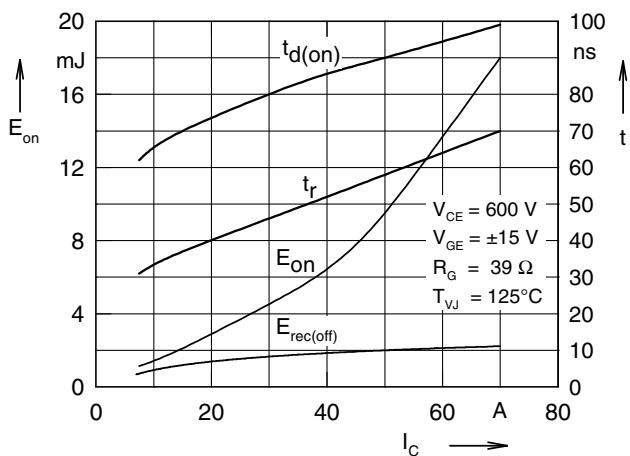

Fig. 13 Typ. turn on energy and switching times versus collector current

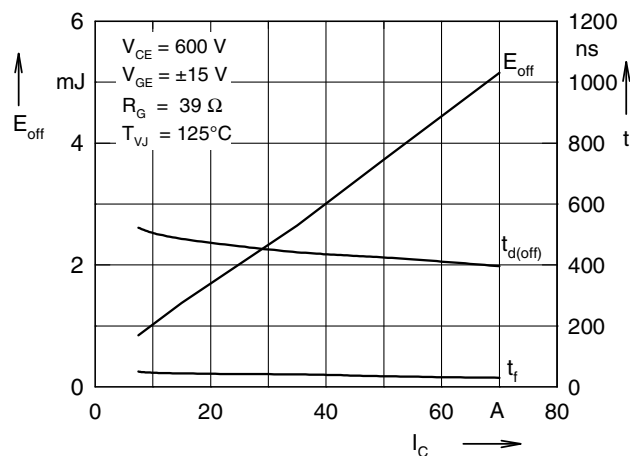

Fig. 14 Typ. turn off energy and switching times versus collector current

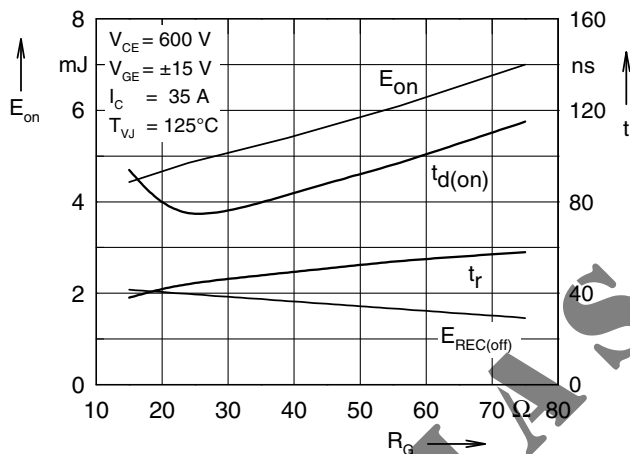

Fig. 15 Typ. turn on energy and switching times versus gate resistor

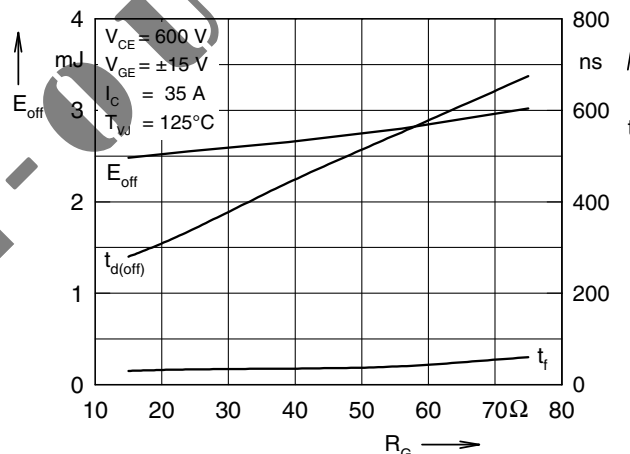

Fig. 16 Typ. turn off energy and switching times versus gate resistor

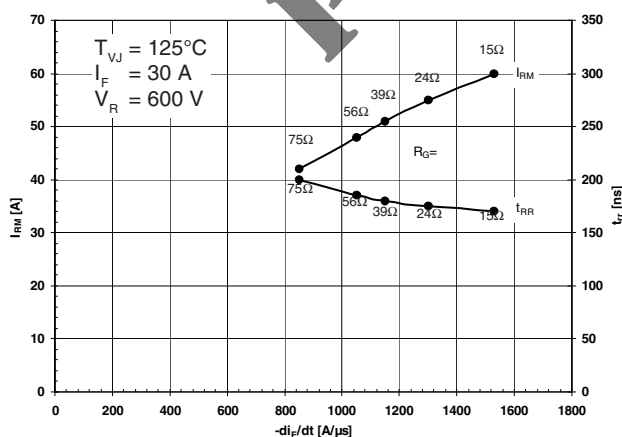

Fig. 17 Typ. turn off characteristics of free wheeling diode

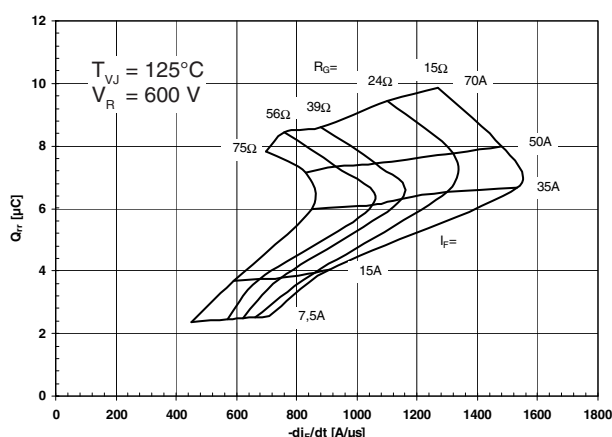

Fig. 18 Typ. turn off characteristics of free wheeling diode

Brake Chopper T7 / D7

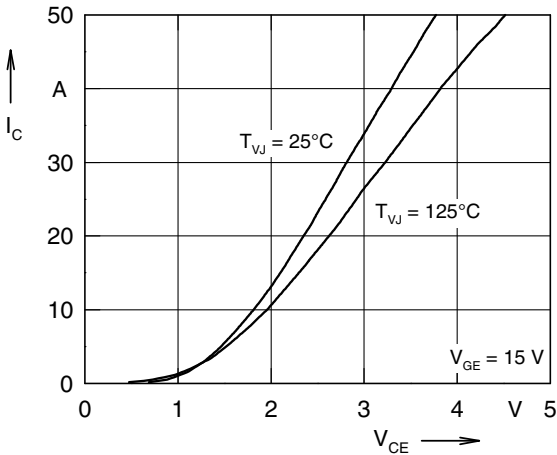

Fig. 19 Typ. output characteristics

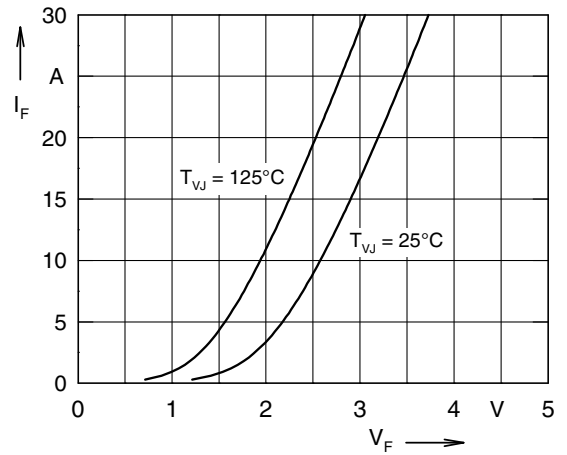

Fig. 20 Typ. forward characteristics of free wheeling diode

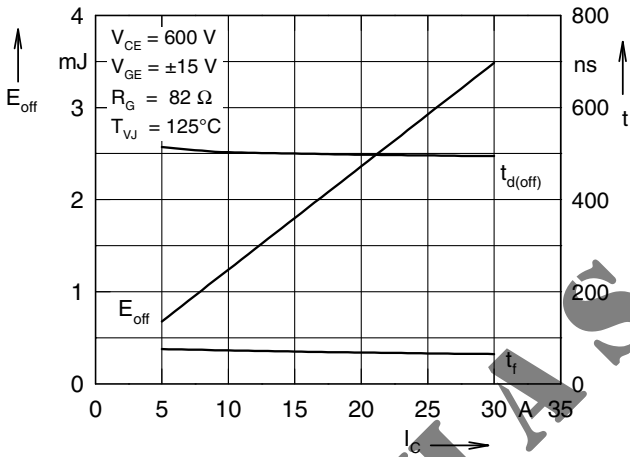

Fig. 21 Typ. turn off energy and switching times versus collector current

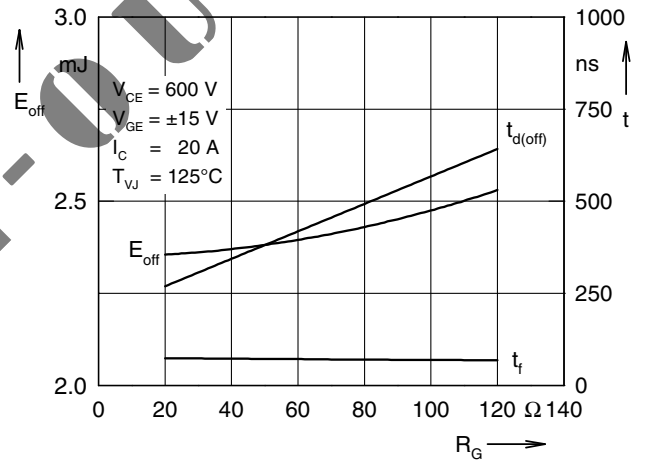

Fig. 22 Typ. turn off energy and switching times versus gate resistor

Temperature Sensor NTC

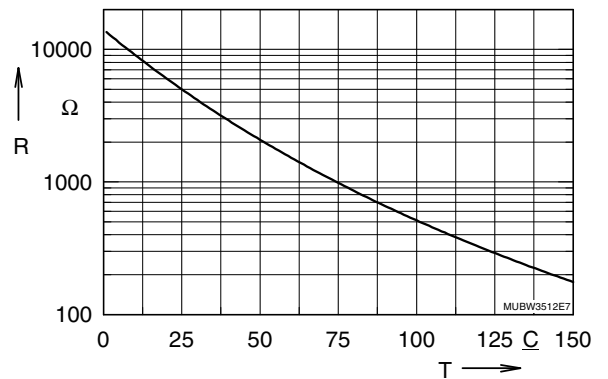

Fig. 24 Typ. thermistorresistance versus temperature