

### MG1215H-XBN2MM

RoHS

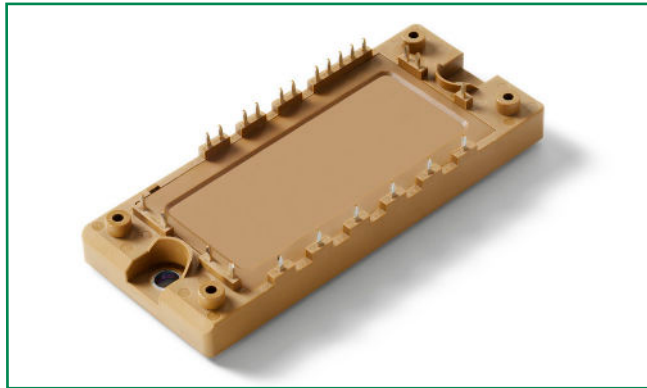

#### Features

- High level of integration—only one power semiconductor module required for the whole drive
- Low saturation voltage and positive temperature coefficient
- Fast switching and short tail current
- Free wheeling diodes with fast and soft reverse recovery
- Industry standard package with insulated copper base plate and soldering pins for PCB mounting
- Temperature sense included

#### Applications

- AC motor control
- Motion/servo control
- Inverter and power supplies

#### Module Characteristics ( $T_j = 25^\circ\text{C}$ , unless otherwise specified)

Symbol	Parameters	Test Conditions	Min	Typ	Max	Unit
$T_{j\max}$	Max. Junction Temperature				150	$^\circ\text{C}$
$T_{j\text{op}}$	Operating Temperature		-40		125	$^\circ\text{C}$
$T_{\text{stg}}$	Storage Temperature		-40		125	$^\circ\text{C}$
$V_{\text{isol}}$	Insulation Test Voltage	AC, $t=1\text{min}$		3000		V
CTI	Comparative Tracking Index		250			
$M_d$	Mounting Torque	Recommended (M5)	2.5		5	N·m
Weight				180		g

#### Absolute Maximum Ratings ( $T_j = 25^\circ\text{C}$ , unless otherwise specified)

Symbol	Parameters	Test Conditions	Values	Unit
<b>IGBT</b>				
$V_{\text{CES}}$	Collector - Emitter Voltage	$T_j=25^\circ\text{C}$	1200	V
$V_{\text{GES}}$	Gate - Emitter Voltage		$\pm 20$	V
$I_c$	DC Collector Current	$T_c=25^\circ\text{C}$	25	A
		$T_c=80^\circ\text{C}$	15	A
$I_{\text{CM}}$	Repetitive Peak Collector Current	$t_p=1\text{ms}$	30	A
$P_{\text{tot}}$	Power Dissipation Per IGBT		105	W
<b>Diode</b>				
$V_{\text{RRM}}$	Repetitive Reverse Voltage	$T_j=25^\circ\text{C}$	1200	V
$I_{\text{F(AV)}}$	Average Forward Current	$T_c=25^\circ\text{C}$	15	A
$I_{\text{FRM}}$	Repetitive Peak Forward Current	$t_p=1\text{ms}$	30	A
$I^2t$		$T_j=125^\circ\text{C}$ , $t=10\text{ms}$ , $V_R=0\text{V}$	60	$\text{A}^2\text{s}$

**Electrical and Thermal Specifications ( $T_J = 25^\circ\text{C}$ , unless otherwise specified)**

Symbol	Parameters	Test Conditions	Min	Typ	Max	Unit
<b>IGBT</b>						
$V_{GE(th)}$	Gate - Emitter Threshold Voltage	$V_{CE}=V_{GE}, I_C=0.6\text{mA}$	5.0	5.8	6.5	V
$V_{CE(sat)}$	Collector - Emitter	$I_C=15\text{A}, V_{GE}=15\text{V}, T_J=25^\circ\text{C}$		1.7	2.15	V
	Saturation Voltage	$I_C=15\text{A}, V_{GE}=15\text{V}, T_J=125^\circ\text{C}$		1.9		V
$I_{ICES}$	Collector Leakage Current	$V_{CE}=1200\text{V}, V_{GE}=0\text{V}, T_J=25^\circ\text{C}$			0.1	mA
		$V_{CE}=1200\text{V}, V_{GE}=0\text{V}, T_J=125^\circ\text{C}$			1	mA
$I_{GES}$	Gate Leakage Current	$V_{CE}=0\text{V}, V_{GE}=\pm 15\text{V}, T_J=125^\circ\text{C}$	-400		400	nA
$R_{Gint}$	Integrated Gate Resistor			0		$\Omega$
$Q_{ge}$	Gate Charge	$V_{CE}=600\text{V}, I_C=15\text{A}, V_{GE}=\pm 15\text{V}$		0.15		$\mu\text{C}$
$C_{ies}$	Input Capacitance	$V_{CE}=25\text{V}, V_{GE}=0\text{V}, f=1\text{MHz}$		1.1		nF
$C_{res}$	Reverse Transfer Capacitance			0.04		nF
$t_{d(on)}$	Turn - on Delay Time	$V_{CC}=600\text{V}$ $I_C=15\text{A}$ $R_G=75\Omega$ $V_{GE}=\pm 15\text{V}$ Inductive Load	$T_J=25^\circ\text{C}$	90		ns
			$T_J=125^\circ\text{C}$	90		ns
$t_r$	Rise Time		$T_J=25^\circ\text{C}$	30		ns
			$T_J=125^\circ\text{C}$	50		ns
$t_{d(off)}$	Turn - off Delay Time		$T_J=25^\circ\text{C}$	420		ns
			$T_J=125^\circ\text{C}$	520		ns
$t_f$	Fall Time		$T_J=25^\circ\text{C}$	70		ns
			$T_J=125^\circ\text{C}$	90		ns
$E_{on}$	Turn - on Energy		$T_J=25^\circ\text{C}$	1.5		mJ
			$T_J=125^\circ\text{C}$	2.1		mJ
$E_{off}$	Turn - off Energy	$T_J=25^\circ\text{C}$	1.1		mJ	
		$T_J=125^\circ\text{C}$	1.3		mJ	
$I_{SC}$	Short Circuit Current	$t_{psc} \leq 10\mu\text{s}, V_{GE}=15\text{V}, T_J=125^\circ\text{C}, V_{CC}=900\text{V}$		60		A
$R_{thJC}$	Junction-to-Case Thermal Resistance (Per IGBT)				1.2	K/W
<b>Diode</b>						
$V_F$	Forward Voltage	$I_F=15\text{A}, V_{GE}=0\text{V}, T_J=25^\circ\text{C}$		1.65	2.15	V
		$I_F=15\text{A}, V_{GE}=0\text{V}, T_J=125^\circ\text{C}$		1.65		V
$t_{RR}$	Reverse Recovery Time	$I_F=15\text{A}, V_R=600\text{V}$ $di_F/dt=-400\text{A}/\mu\text{s}$ $T_J=125^\circ\text{C}$		150		ns
$I_{RRM}$	Max. Reverse Recovery Current			16		A
$E_{rec}$	Reverse Recovery Energy			1.1		mJ
$R_{thJCD}$	Junction-to-Case Thermal Resistance (Per Diode)				1.5	K/W

### Diode-Rectifier Absolute Maximum Ratings ( $T_J = 25^\circ\text{C}$ , unless otherwise specified)

Symbol	Parameters	Test Conditions	Values	Unit
$V_{RRM}$	Repetitive Reverse Voltage	$T_J = 25^\circ\text{C}$	1600	V
$I_{F(RMS)}$	R.M.S. Forward Current Per Diode	$T_C = 80^\circ\text{C}$	50	A
$I_{FSM}$	Non-Repetitive Surge Forward Current	$T_J = 45^\circ\text{C}$ , $t = 10\text{ms}$ , 50Hz	320	A
		$T_J = 45^\circ\text{C}$ , $t = 8.3\text{ms}$ , 60Hz	360	A
$I^2t$		$T_J = 45^\circ\text{C}$ , $t = 10\text{ms}$ , 50Hz	512	$\text{A}^2\text{s}$
		$T_J = 45^\circ\text{C}$ , $t = 8.3\text{ms}$ , 60Hz	537	$\text{A}^2\text{s}$

### Diode-Rectifier Electrical and Thermal Specifications ( $T_J = 25^\circ\text{C}$ , unless otherwise specified)

Symbol	Parameters	Test Conditions	Min	Typ	Max	Unit
$V_F$	Forward Voltage	$I_F = 15\text{A}$ , $V_{GE} = 0\text{V}$ , $T_J = 25^\circ\text{C}$		1.0		V
		$I_F = 15\text{A}$ , $V_{GE} = 0\text{V}$ , $T_J = 125^\circ\text{C}$		0.9		V
$I_R$	Reverse Leakage Current	$V_R = 1600\text{V}$ , $T_J = 25^\circ\text{C}$			50	$\mu\text{A}$
		$V_R = 1600\text{V}$ , $T_J = 125^\circ\text{C}$			1	mA
$R_{thJCD}$	Junction-to-Case Thermal Resistance (Per Diode)				1.05	$\text{K/W}$

### Brake-Chopper Absolute Maximum Ratings ( $T_J = 25^\circ\text{C}$ , unless otherwise specified)

Symbol	Parameters	Test Conditions	Values	Unit
<b>IGBT</b>				
$V_{CES}$	Collector - Emitter Voltage	$T_J = 25^\circ\text{C}$	1200	V
$V_{GES}$	Gate - Emitter Voltage		$\pm 20$	V
$I_C$	DC Collector Current	$T_C = 25^\circ\text{C}$	25	A
		$T_C = 80^\circ\text{C}$	15	A
$I_{CM}$	Repetitive Peak Collector Current	$t_p = 1\text{ms}$	30	A
$P_{tot}$	Power Dissipation Per IGBT		105	W
<b>Diode</b>				
$V_{RRM}$	Repetitive Reverse Voltage	$T_J = 25^\circ\text{C}$	1200	V
$I_{F(AV)}$	Average Forward Current	$T_C = 25^\circ\text{C}$	15	A
$I_{FRM}$	Repetitive Peak Forward Current	$t_p = 1\text{ms}$	30	A
$I^2t$		$T_J = 125^\circ\text{C}$ , $t = 10\text{ms}$ , $V_R = 0\text{V}$	60	$\text{A}^2\text{s}$

### Brake-Chopper Electrical and Thermal Specifications ( $T_J = 25^\circ\text{C}$ , unless otherwise specified)

Symbol	Parameters	Test Conditions	Min	Typ	Max	Unit
<b>IGBT</b>						
$V_{GE(th)}$	Gate - Emitter Threshold Voltage	$V_{CE}=V_{GE}, I_C=0.6\text{mA}$	5.0	5.8	6.5	V
$V_{CE(sat)}$	Collector - Emitter Saturation Voltage	$I_C=15\text{A}, V_{GE}=15\text{V}, T_J=25^\circ\text{C}$		1.7	2.15	V
		$I_C=15\text{A}, V_{GE}=15\text{V}, T_J=125^\circ\text{C}$		1.9		V
$I_{ICES}$	Collector Leakage Current	$V_{CE}=1200\text{V}, V_{GE}=0\text{V}, T_J=25^\circ\text{C}$			50	$\mu\text{A}$
		$V_{CE}=1200\text{V}, V_{GE}=0\text{V}, T_J=125^\circ\text{C}$			1	mA
$I_{GES}$	Gate Leakage Current	$V_{CE}=0\text{V}, V_{GE}=\pm 15\text{V}, T_J=125^\circ\text{C}$	-400		400	nA
$R_{Gint}$	Integrated Gate Resistor			0		$\Omega$
$Q_{ge}$	Gate Charge	$V_{CE}=600\text{V}, I_C=15\text{A}, V_{GE}=\pm 15\text{V}$		0.15		$\mu\text{C}$
$C_{ies}$	Input Capacitance	$V_{CE}=25\text{V}, V_{GE}=0\text{V}, f=1\text{MHz}$		1.1		nF
$C_{res}$	Reverse Transfer Capacitance				0.04	
$t_{d(on)}$	Turn - on Delay Time	$V_{CC}=600\text{V}$ $I_C=15\text{A}$ $R_G=75\Omega$ $V_{GE}=\pm 15\text{V}$ Inductive Load	$T_J=25^\circ\text{C}$		90	ns
			$T_J=125^\circ\text{C}$		90	ns
$t_r$	Rise Time		$T_J=25^\circ\text{C}$		30	ns
			$T_J=125^\circ\text{C}$		50	ns
$t_{d(off)}$	Turn - off Delay Time		$T_J=25^\circ\text{C}$		420	ns
			$T_J=125^\circ\text{C}$		520	ns
$t_f$	Fall Time		$T_J=25^\circ\text{C}$		70	ns
			$T_J=125^\circ\text{C}$		90	ns
$E_{on}$	Turn - on Energy		$T_J=25^\circ\text{C}$		1.5	mJ
			$T_J=125^\circ\text{C}$		2.1	mJ
$E_{off}$	Turn - off Energy	$T_J=25^\circ\text{C}$		1.1	mJ	
		$T_J=125^\circ\text{C}$		1.3	mJ	
$I_{SC}$	Short Circuit Current	$t_{psc} \leq 10\mu\text{s}, V_{GE}=15\text{V}, T_J=125^\circ\text{C}, V_{CC}=900\text{V}$		60		A
$R_{thJC}$	Junction-to-Case Thermal Resistance (Per IGBT)				1.2	K/W
<b>Diode</b>						
$V_F$	Forward Voltage	$I_F=15\text{A}, V_{GE}=0\text{V}, T_J=25^\circ\text{C}$		1.65	2.15	V
		$I_F=15\text{A}, V_{GE}=0\text{V}, T_J=125^\circ\text{C}$		1.65		V
$t_{RR}$	Reverse Recovery Time	$I_F=15\text{A}, V_R=600\text{V}$ $di_p/dt=-400\text{A}/\mu\text{s}$ $T_J=125^\circ\text{C}$		150		ns
$I_{RRM}$	Max. Reverse Recovery Current			16		A
$E_{rec}$	Reverse Recovery Energy			1.1		mJ
$R_{thJCD}$	Junction-to-Case Thermal Resistance (Per Diode)				1.5	K/W

### NTC Characteristics ( $T_J = 25^\circ\text{C}$ , unless otherwise specified)

Symbol	Parameters	Test Conditions	Min	Typ	Max	Unit
$R_{25}$	Resistance	$T_c=25^\circ\text{C}$		5		K $\Omega$
$B_{25/50}$				3375		K

**Figure 1: Typical Output Characteristics for IGBT Inverter**

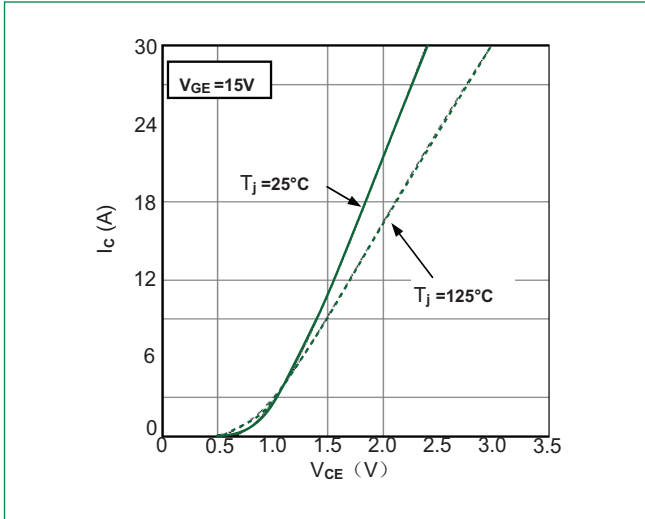

**Figure 2: Typical Output Characteristics for IGBT Inverter**

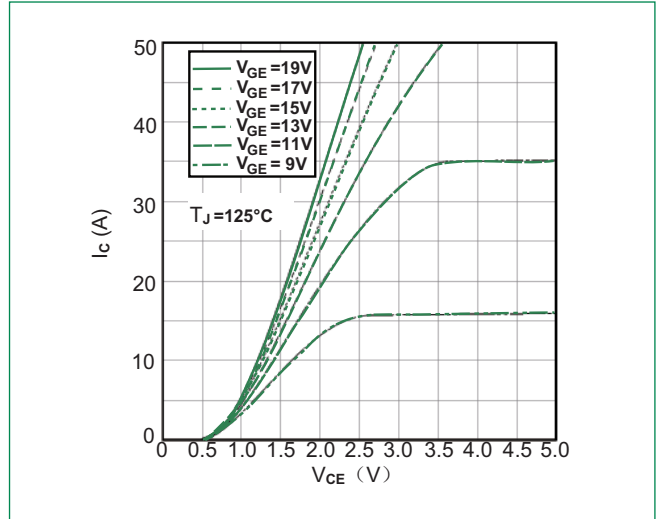

**Figure 3: Typical Transfer Characteristics for IGBT Inverter**

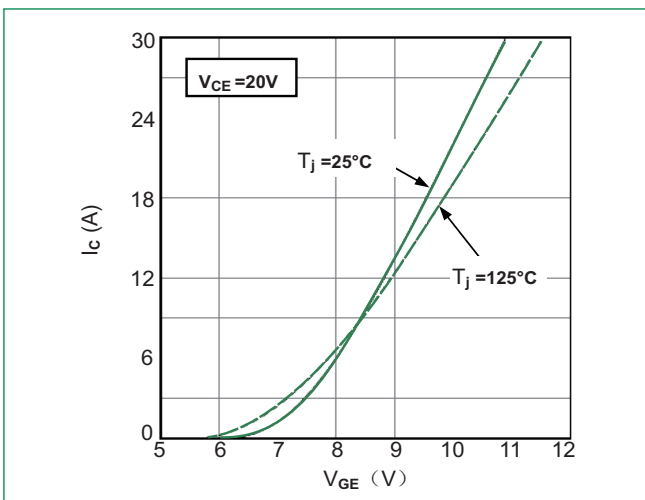

**Figure 4: Switching Energy vs. Gate Resistor for IGBT Inverter**

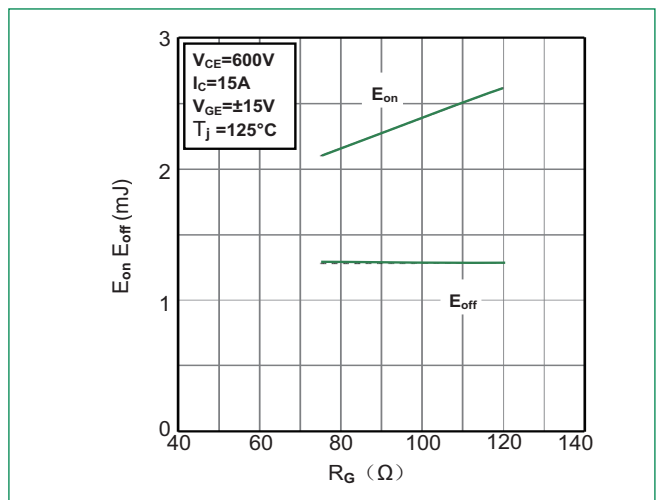

**Figure 5: Switching Energy vs. Collector Current for IGBT Inverter**

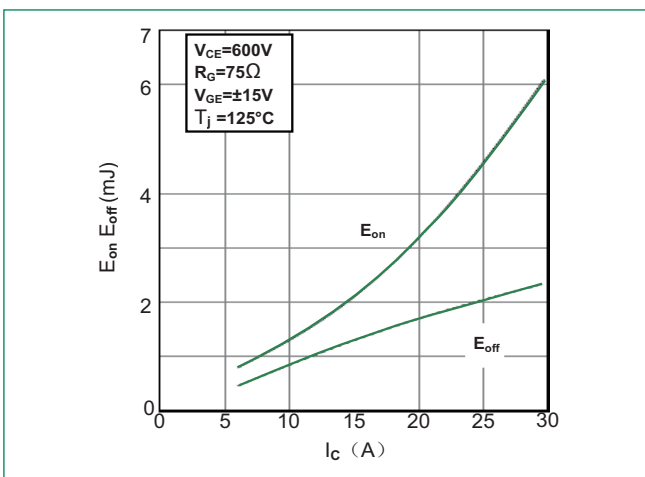

**Figure 6: Reverse Biased Safe Operating Area for IGBT Inverter**

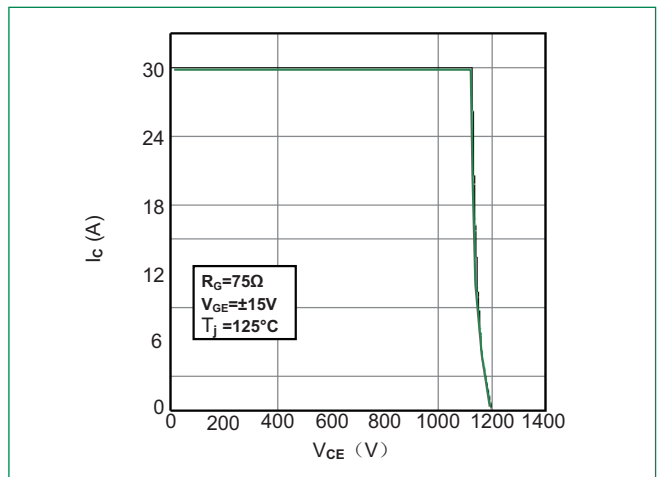

**Figure 7: Diode Forward Characteristics for Diode Inverter**

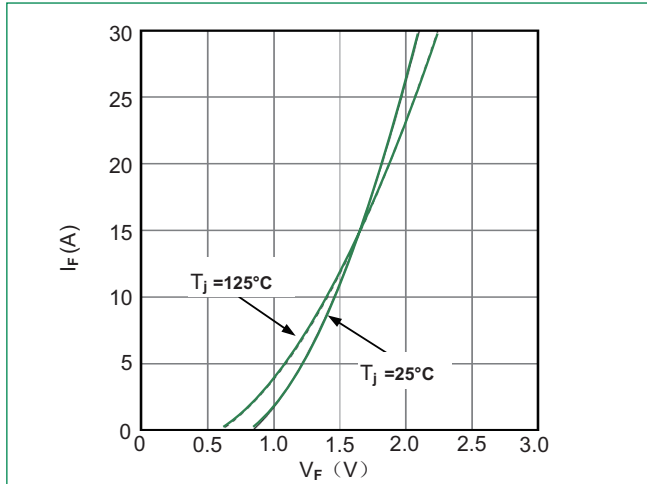

**Figure 8: Switching Energy vs. Gate Resistort for Diode Inverter**

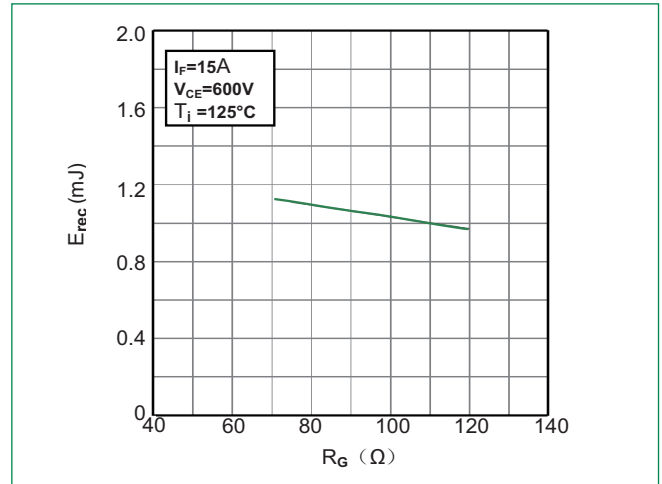

**Figure 9: Switching Energy vs. Forward Current Diode-inverter**

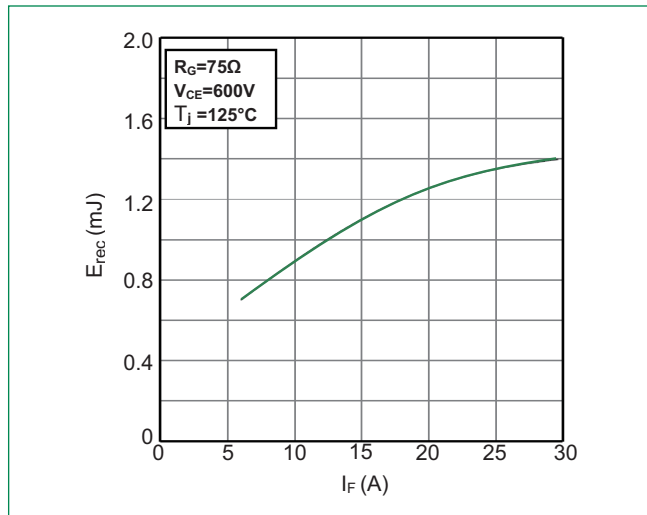

**Figure 10: Transient Thermal Impedance of Diode and IGBT-inverter**

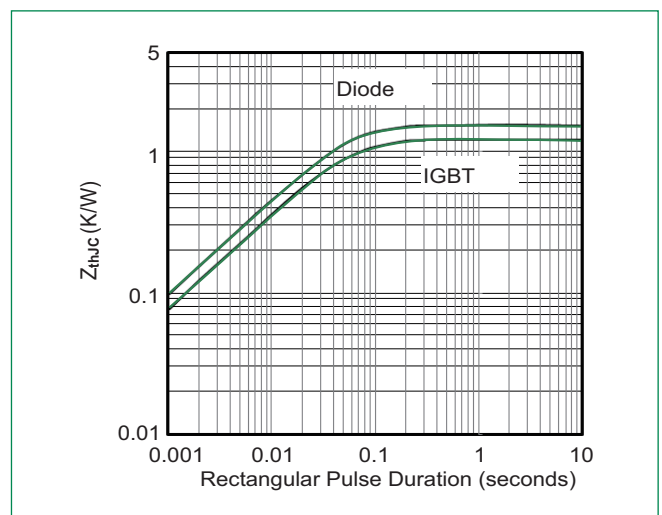

**Figure 11: Diode Forward Characteristics Diode- rectifier**

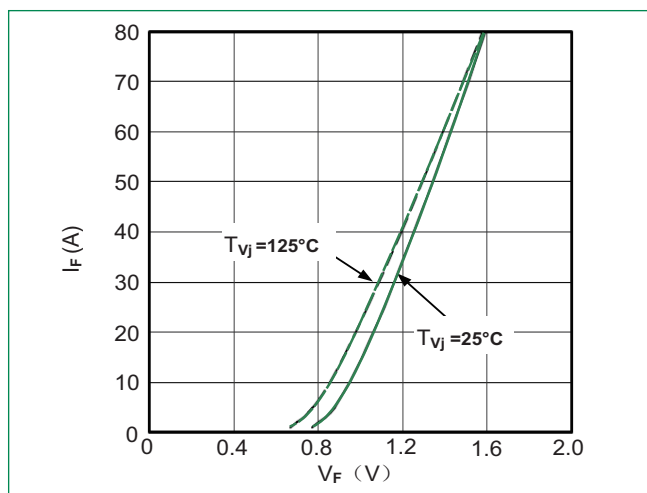

**Figure 12: Typical Output Characteristics IGBT- brake chopper**

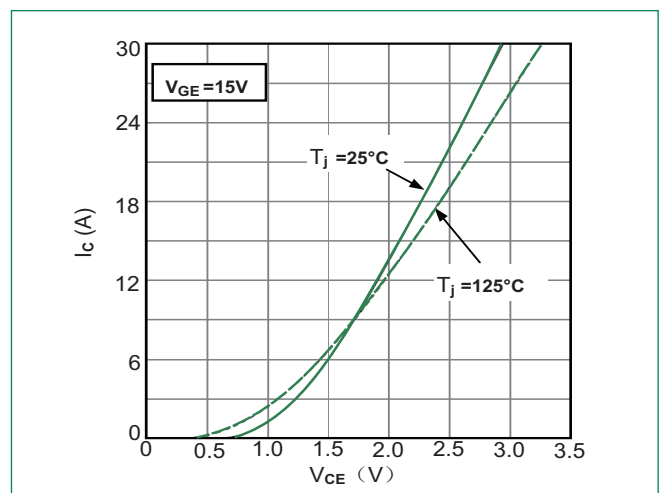

**Figure 13: Diode Forward Characteristics**  
Diode - brake chopper

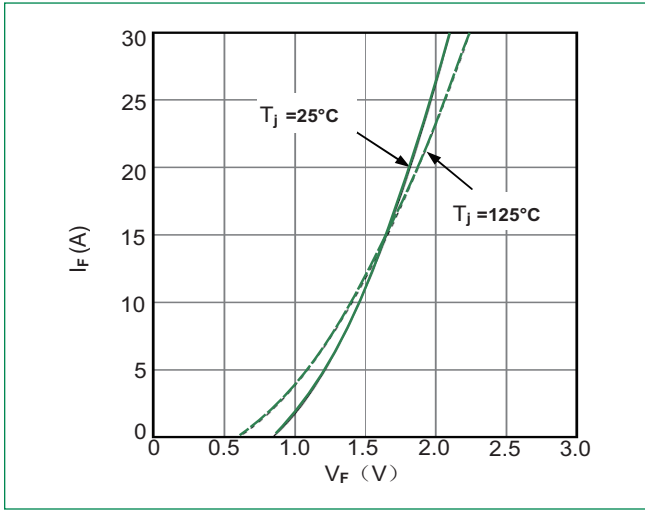

**Figure 14: NTC Characteristics**

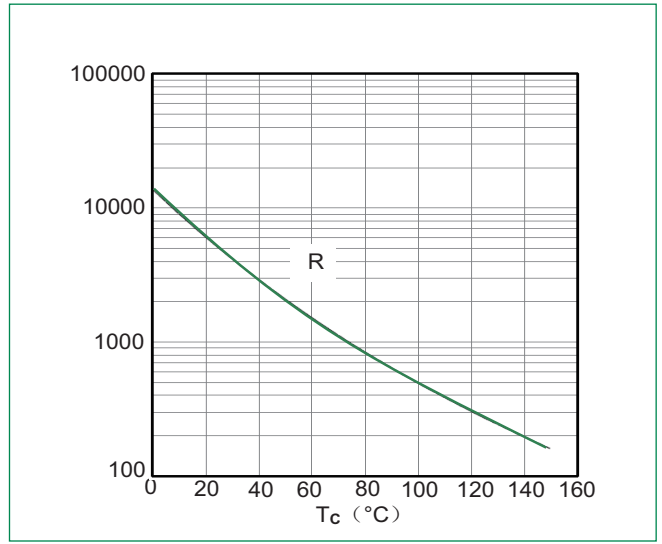

### Circuit Diagram

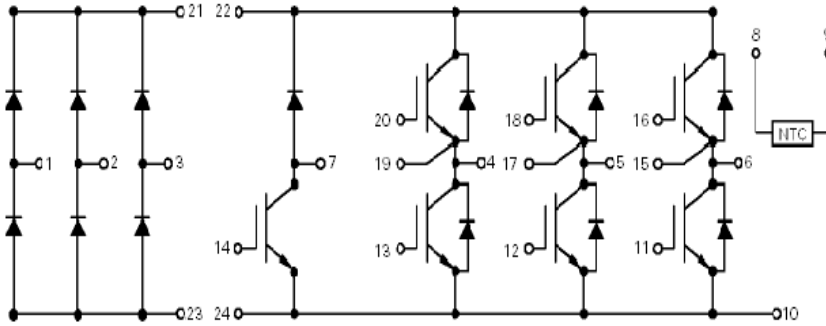

### Dimensions-Package H

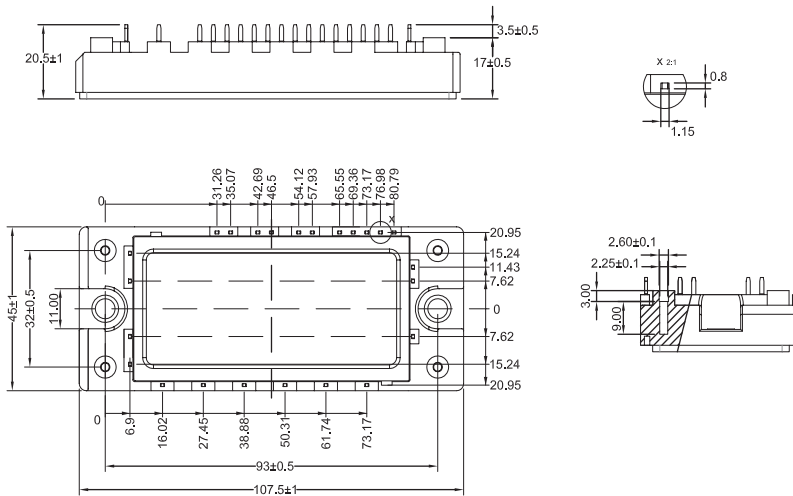

The foot pins are in gold / nickel coating

### Packing Options

Part Number	Marking	Weight	Packing Mode	M.O.Q
MG1215H-XBN2MM	MG1215H-XBN2MM	180g	Bulk Pack	40

### Part Numbering System

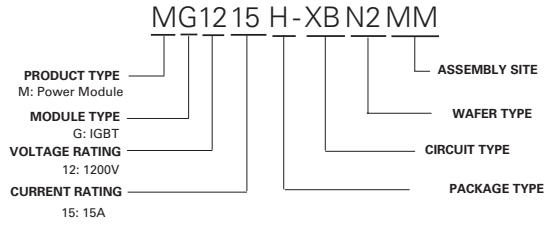

### Part Marking System

