

PRELIMINARY



WMS7120/1

NONVOLATILE DIGITAL POTENTIOMETERS

WITH UP/DOWN (3-WIRE) INTERFACE,

10KOHM, 50KOHM, 100KOHM RESISTANCE

64 TAPS

WITH OPTIONAL OUTPUT BUFFER



1. GENERAL DESCRIPTION

The WMS712x is a 64 non-volatile linear digital potentiometers available in 10K Ω , 50K Ω and 100K Ω resistance values. The WMS7120/1 can be used as a three-terminal potentiometer or as a two terminal variable resistor in a wide variety of applications.

The output of each potentiometer is determined by the wiper position, which varies in linearly between V_A and V_B terminal according to the content stored in the volatile Tap Register (TR) which is programmed through Up/Down (Increment/Decrement) interface. The channel has one non-volatile memory location (NVMEM0) that can be directly written to by users through the Up/Down interface. Power-on recall is also built in so the content of the NVMEM0 to Tap Register is automatically loaded.

The WMS7120/1 devices pin out the resistor wiper directly. The WMS7121 devices feature an output buffer with 3mA minimum drive capability.

All the WMS7120/1 devices are single channel devices offered in 8-pin PDIP, SOIC and MSOP packages. The WMS7120/1 devices operate over a wide operating voltage ranging from 2.7V to 5.5V.

2. FEATURES

- Drop-in replacements for many popular parts
- Available output buffer for WMS7121 devices
- Single linear-taper channel
- 64 taps
- 10K, 50K and 100K end-to end resistance
- V_{SS} to V_{DD} terminal voltages
- Non-volatile storage of wiper positions with power-on recall
- Data storage and potentiometer control through Up/Down (3-wire) interface
- Endurance 100,000 write cycles
- Data retention 100 years
- Package options:
 - 8-pin PDIP, SOIC or MSOP
- Industrial temperature range: -40° ~ 85°C
- Single supply operation 2.7V to 5.5V



3. BLOCK DIAGRAM

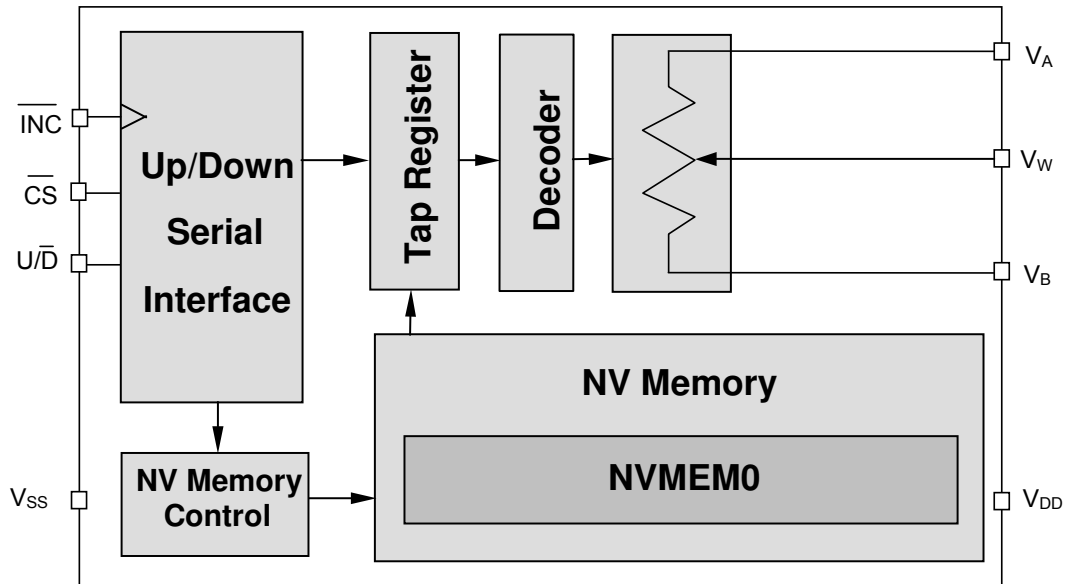

FIGURE 1 – WMS7120 BLOCK DIAGRAM (Rheostat Mode)

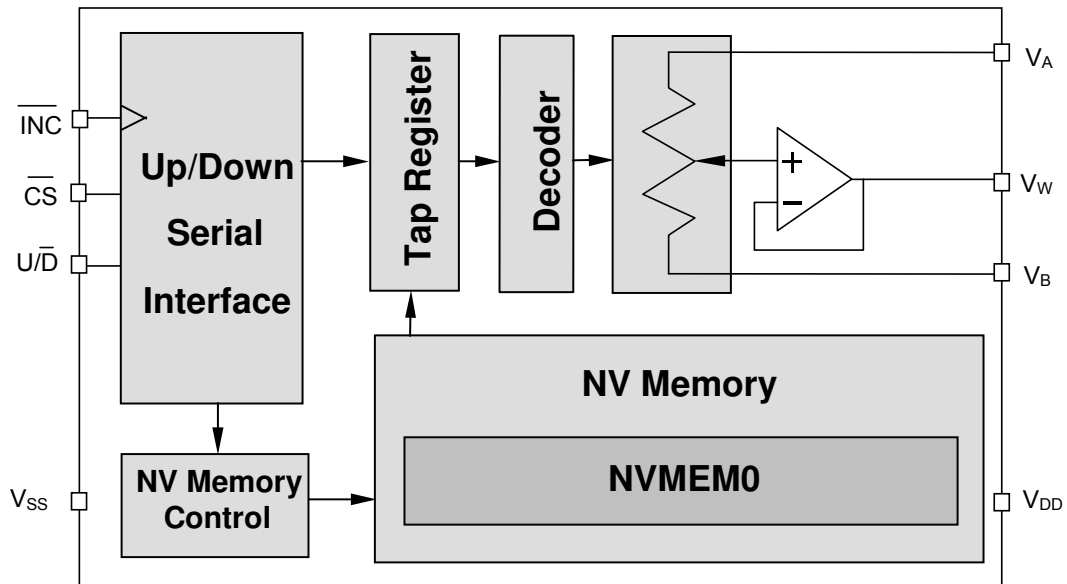

FIGURE 2 – WMS7121 BLOCK DIAGRAM (Divider Mode)



4. TABLE OF CONTENTS

1. GENERAL DESCRIPTION.....	2
2. FEATURES	2
3. BLOCK DIAGRAM	3
4. TABLE OF CONTENTS	4
5. PIN CONFIGURATION	5
6. PIN DESCRIPTION	6
7. FUNCTIONAL DESCRIPTION.....	7
7.1. Potentiometer and Rheostat Modes	7
7.1.1. Rheostat Configuration	7
7.1.2. Potentiometer Configuration	7
7.2. Non-Volatile Memory (NVMEM)	7
7.3. Serial Data Interface	8
7.4. Operation Overview	8
8. TIMING DIAGRAMS.....	9
9. ABSOLUTE MAXIMUM RATINGS.....	11
10. ELECTRICAL CHARACTERISTICS	12
10.1 Test Circuits	14
11. TYPICAL APPLICATION CIRCUITS	15
11.1. Layout Considerations	17
12. PACKAGE DRAWINGS AND DIMENSIONS.....	18
13. ORDERING INFORMATION.....	21
14. VERSION HISTORY	22



5. PIN CONFIGURATION

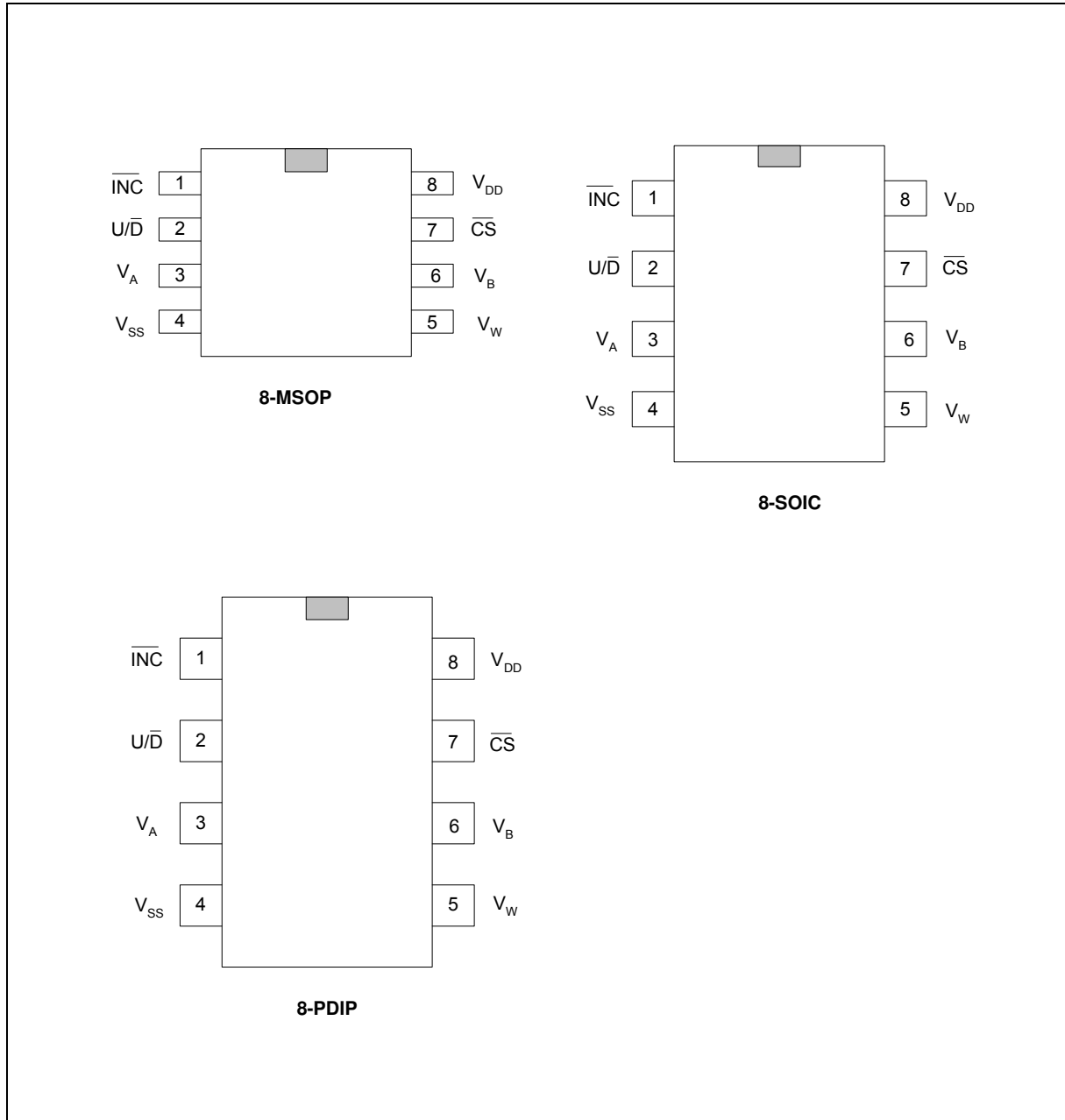



6. PIN DESCRIPTION

TABLE 1 – PIN DESCRIPTION

Pin Name	I/O	Description
$\overline{\text{INC}}$	I	Increment Control. A High-Low transition of $\overline{\text{INC}}$ when $\overline{\text{CS}}$ is low will move the wiper up or down for one increment based on the $\text{U}/\overline{\text{D}}$ input
$\text{U}/\overline{\text{D}}$	I	Up/Down control Input. High state will cause the wiper to move to the V_B terminal, Low state to the V_A terminal
V_A	-	High terminal of WinPot
V_SS	-	Ground pin, logic ground reference
V_DD	-	Power Supply
$\overline{\text{CS}}$	I	Chip Select. When $\overline{\text{CS}}$ is HIGH, the part is deselected and the device will be in the standby mode. $\overline{\text{CS}}$ LOW enables the part, placing it in the active power mode
V_B	-	Low terminal of WinPot
V_W	O	Wiper terminal of WinPot (can be buffered), its position on the resistor array is controlled by the inputs on $\overline{\text{INC}}$, $\text{U}/\overline{\text{D}}$, and $\overline{\text{CS}}$



7. FUNCTIONAL DESCRIPTION

The WMS7120/1, a nonvolatile digitally programmable potentiometers with 64 taps, with or without output buffer, is designed to operate as both a potentiometer or a variable resistor depending upon the output configuration selected.

The chip can store up to one 8-bit word in a nonvolatile memory (NVMEM0) in order to set the tap register value when the device is powered up.

The WMS7120/1 is controlled by a serial Up-Down (3-wire) interface that allows setting the tap register value as well as storing data in the nonvolatile memory.

7.1. POTENTIOMETER AND RHEOSTAT MODES

The WMS7120/1 can operate as either a rheostat or as a potentiometer (voltage divider). When in the potentiometer configuration there are two possible modes. One is done using WMS7120 Winpot device without the output buffer and the other mode is done with WMS7121 WinPot device with the output buffer.

7.1.1. Rheostat Configuration

The WMS7120/1 acts as a two terminal resistive element in the rheostat configuration where one terminal can be connected to either the end point pins of the resistor (V_A and V_B) and the other terminal is the wiper (V_W) pin. This configuration controls the resistance between the two terminals and the resistance can be adjusted by sending the corresponding tap register setting to the WMS7120/1 or can also be set by loading a pre-set tap register value from nonvolatile memory NVMEM0 upon power up.

7.1.2. Potentiometer Configuration

In potentiometer configuration an input voltage is applied to either one of the end point pins (V_A or V_B). The voltage on the wiper pin will be proportional to the voltage difference between V_A and V_B and the wiper setting. The resistance cannot be directly measured in this configuration.

7.2. NON-VOLATILE MEMORY (NVMEM)

The WMS7120/1 has one NVMEM position available for storing the potentiometer setting. The NVMEM position can be directly written via the Up/Down interface. The potentiometer is loaded with the value stored in the NVMEM0 on power up.



7.3. SERIAL DATA INTERFACE

The Up/Down family has a 3-wire Serial Data Interface consisting of \overline{CS} , \overline{INC} , U/\overline{D} pins. Only UP/DOWN operations can be performed. The key features of this interface include:



- Increment/Decrement operations on the tap register (TR)
- Direct refresh of tap register (TR) from internal NVMEM
- Nonvolatile storage of the present tap register value into the NVMEM and automatic recall at power up
- For WMS7121 devices, output buffer amplifier

7.4. OPERATION OVERVIEW

The wiper position or the Tap Register(TR) setting can only be changed by the UP/DOWN operation with the combination of \overline{CS} , U/\overline{D} , and \overline{INC} signals. When \overline{CS} is low, the part will be activated and the TR setting can be changed by toggling \overline{INC} , and TR will move up when U/\overline{D} is High and move down when U/\overline{D} is Low. The TR setting will be stored into the user NVMEM automatically each time \overline{CS} goes high while \overline{INC} holds high. Otherwise, if \overline{INC} is low when \overline{CS} goes high, the TR setting will not be stored. The NVMEM content will be automatically loaded into TR at Power On. The user NVMEM can be tested through the voltage measurement on the wiper pin after saving TR setting into the NVMEM and reloading into the TR. When the TR setting is already at LOW, further DOWN operations won't change the setting. Similarly, when TR setting is at HIGH, further UP operations won't change the setting.

When \overline{CS} is held HIGH, the part will be in Standby mode and the TR setting will not be changed.

The operating modes of Up/Down are summarized below.

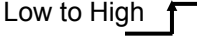
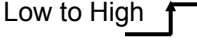
\overline{CS}	U/\overline{D}	\overline{INC}	Operation
Low	High	 High to Low	Wiper toward V_A
Low	Low	 High to Low	Wiper toward V_B
Low to High 	x	High	Store Wiper Position
Low to High 	x	Low	No Store, Return to Standby
High	x	x	Standby

Note: x means don't care



8. TIMING DIAGRAMS

Conditions: $V_{DD} = +2.7V$ to $5.5V$, $V_A = V_{DD}$, $V_B = 0V$, $T = 25^\circ C$

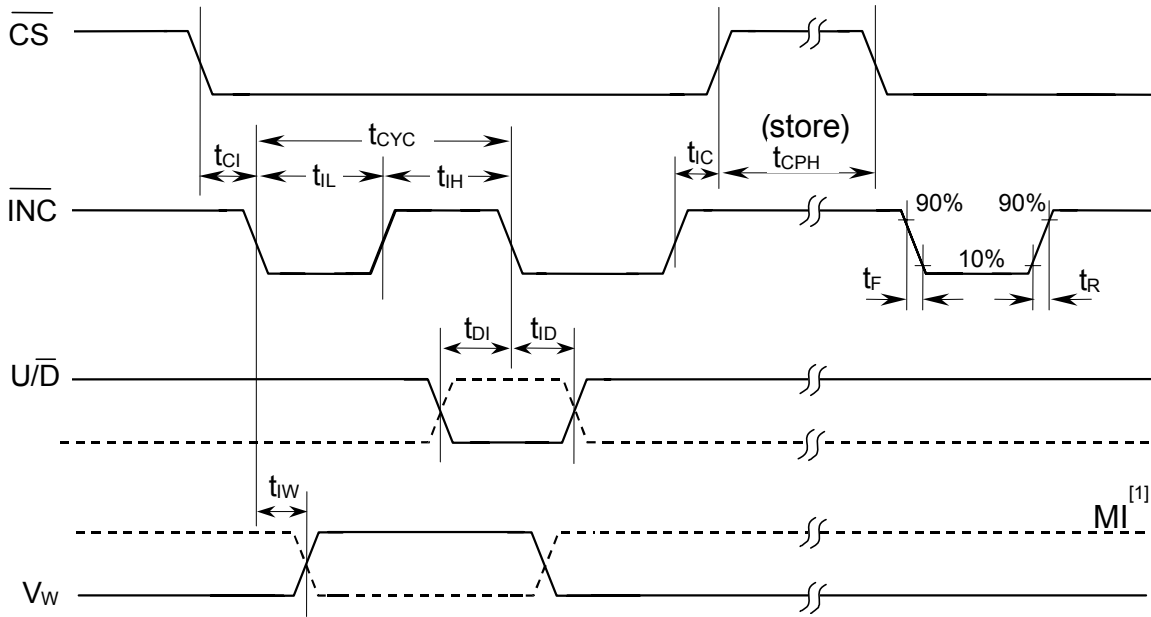

FIGURE 3 –WMS7120/1 TIMING DIAGRAM

Note:

[1] MI in the AC Timing diagram (Figure 3) refers to the minimum incremental change in the wiper output due to a change in the wiper position.



TABLE 10 – TIMING PARAMETERS

PARAMETERS	SYMBOL	MIN.	MAX.	UNITS
$\overline{\text{CS}}$ to $\overline{\text{INC}}$ Setup	t_{CI}	100		ns
$\text{U}/\overline{\text{D}}$ to $\overline{\text{INC}}$ Setup	t_{DI}	50		ns
$\text{U}/\overline{\text{D}}$ to $\overline{\text{INC}}$ Hold	t_{ID}	100		ns
$\overline{\text{INC}}$ LOW Period	t_{IL}	250		ns
$\overline{\text{INC}}$ HIGH Period	t_{IH}	250		ns
$\overline{\text{INC}}$ Inactive to $\overline{\text{CS}}$ Inactive	t_{IC}	1		μs
$\overline{\text{CS}}$ Deselect Time (NO STORE)	t_{CPH}	100		ns
$\overline{\text{CS}}$ Deselect Time (STORE)	t_{CPH}	15 (2.7V)		ms
$\overline{\text{INC}}$ to V_{W} Change	t_{IW}		5	μs
$\overline{\text{INC}}$ Cycle Time	t_{CYC}	1		μs
$\overline{\text{INC}}$ Input Rise and Fall Time	$t_{\text{R}}, t_{\text{F}}$		500	μs
Power-Up to Wiper Stable	t_{PU}		1	ms
V_{CC} Power-Up rate	$t_{\text{R}} V_{\text{CC}}$	0.2 (13ms 0-2.7V)	50 (54 μs 0-2.7V)	V/ms



9. ABSOLUTE MAXIMUM RATINGS

TABLE 11 – ABSOLUTE MAXIMUM RATINGS (PACKAGED PARTS)^[1]

Conditions	Values
Junction temperature	150°C
Storage temperature	-65° to +150°C
Voltage applied to any pad	(V _{SS} – 0.3V) to (V _{DD} + 0.3V)
V _{DD} – V _{SS}	-0.3 to 7.0V

TABLE 12 – OPERATING CONDITIONS (PACKAGED PARTS)

Conditions	Values
Commercial operating temperature range	0°C to +70°C
Extended operating temperature	-20°C to +70°C
Industrial operating temperature	-40°C to +85°C
Supply voltage (V _{DD})	+2.7V to +5.5V
Ground voltage (V _{SS})	0V

^[1] Stresses above those listed may cause permanent damage to the device. Exposure to the absolute maximum ratings may affect device reliability. Functional operation is not implied at these conditions



10. ELECTRICAL CHARACTERISTICS

TABLE 12 – ELECTRICAL CHARACTERISTICS (Packaged parts)

PARAMETERS	SYMBOL	MIN.	TYP.	MAX.	UNITS	CONDITIONS
Rheostat Mode						
Nominal Resistance	R	-20		+20	%	T=25°C, V _W open
Different Non Linearity ^[2]	DNL	-1		+1	LSB	
Integral Non Linearity ^[2]	INL	-1		+1	LSB	
Tempo ¹	$\Delta R_{AB}/\Delta T$		300		ppm/°C	
Wiper Resistance ^[2]	R _W		50		Ω	V _{DD} =5V, I=V _{DD} /R _{Total}
			80		Ω	V _{DD} =2.7V, I=V _{DD} /R _{Total}
Wiper Current	I _W	-1		1	mA	
Divider Mode						
Resolution	N	8			Bits	
Different Non Linearity ^[2]	DNL	-1	±0.5	+1	LSB	
Integral Non Linearity ^[2]	INL	-1	±0.5	+1	LSB	
Temperature Coefficient ^[1]	$\Delta V_w/\Delta T$		+20		ppm/°C	Code = 80h
Full Scale Error	V _{FSE}	-1		0	LSB	Code = Full Scale
Zero Scale Error	V _{ZSE}	0		1	LSB	Code = Zero Scale
Resistor Terminal						
Voltage Range	V _A , V _B , V _W	V _{SS}		V _{DD}	V	
Terminal Capacitance ^[1]	C _A , C _B		30		pF	
Wiper Capacitance ^[1]			30		pF	
Dynamic Characteristics ^[1]						
Bandwidth –3dB	BW _{10K}		1.5		MHz	V _{DD} =5V, V _B =V _{SS}
	BW _{50K}		300		KHz	Code = 80h
	BW _{100K}		200		KHz	
Settling Time to 1 LSB	T _S		80	100	uS	
Analog Output (Buffer enables)						
Amp Output Current	I _{OUT}	3			mA	V _O =1/2 scale
Amp Output Resistance	R _{out}		1	10	Ω	I _L = 100uA
Total Harmonic Distortion ^[1]	THD			0.08	%	V _A =2.5V, V _{DD} =5V, f=1kHz, V _{IN} =1V _{RMS}
Digital Inputs/Outputs						
Input High Voltage	V _{IH}	0.7V _{DD}			V	
Input Low Voltage	V _{IL}			0.3V _{DD}	V	



PARAMETERS	SYMBOL	MIN.	TYP.	MAX.	UNITS	CONDITIONS
Output Low Voltage	V_{OL}			0.4	V	$I_{OL}=2mA$
Input Leakage Current	I_{LI}	-1		+1	μA	$\overline{CS}=V_{DD}, Vin=V_{SS} \sim V_{DD}$
Output Leakage Current	I_{Lo}	-1		+1	μA	$\overline{CS}=V_{DD}, Vin=V_{SS} \sim V_{DD}$
Input Capacitance ^[1]	C_{IN}		25		pF	$V_{DD}=5V, fc = 1Mhz$
Output Capacitance ^[1]	C_{OUT}		25		pF	$V_{DD}=5V, fc = 1Mhz$
Power Requirements						
Operating Voltage	V_{DD}	2.7		5.5	V	
Operating Current	I_{DDR}		0.5	1	mA	All ops except NVMEM program
Operating Current	I_{DDW}		1	2	mA	During Non-volatile memory program
Standby Current	I_{SA} ^[3]		0.5	1	mA	Buffer is active, NOP, no load
	I_{SB} ^[4]		0.1	1	μA	Buffer is inactive, Power Down, No load
Power Supply Rejection Ratio	PSRR			1	LSB/V	$V_{DD}=5V \pm 10\%, Code=80H$

Notes:

[1] Not subject to production test.

[2] $LSB = (V_A - V_B) / (T - 1)$; $DNL = (V_{i+1} - V_i) / LSB$; $INL = (V_i - i * LSB) / LSB$;
where $i = [0, (T - 1)]$ and $T = \#$ of taps of the device.

[3] WMS71x1 only.

[4] WMS71x0 only.



10.1 TEST CIRCUITS

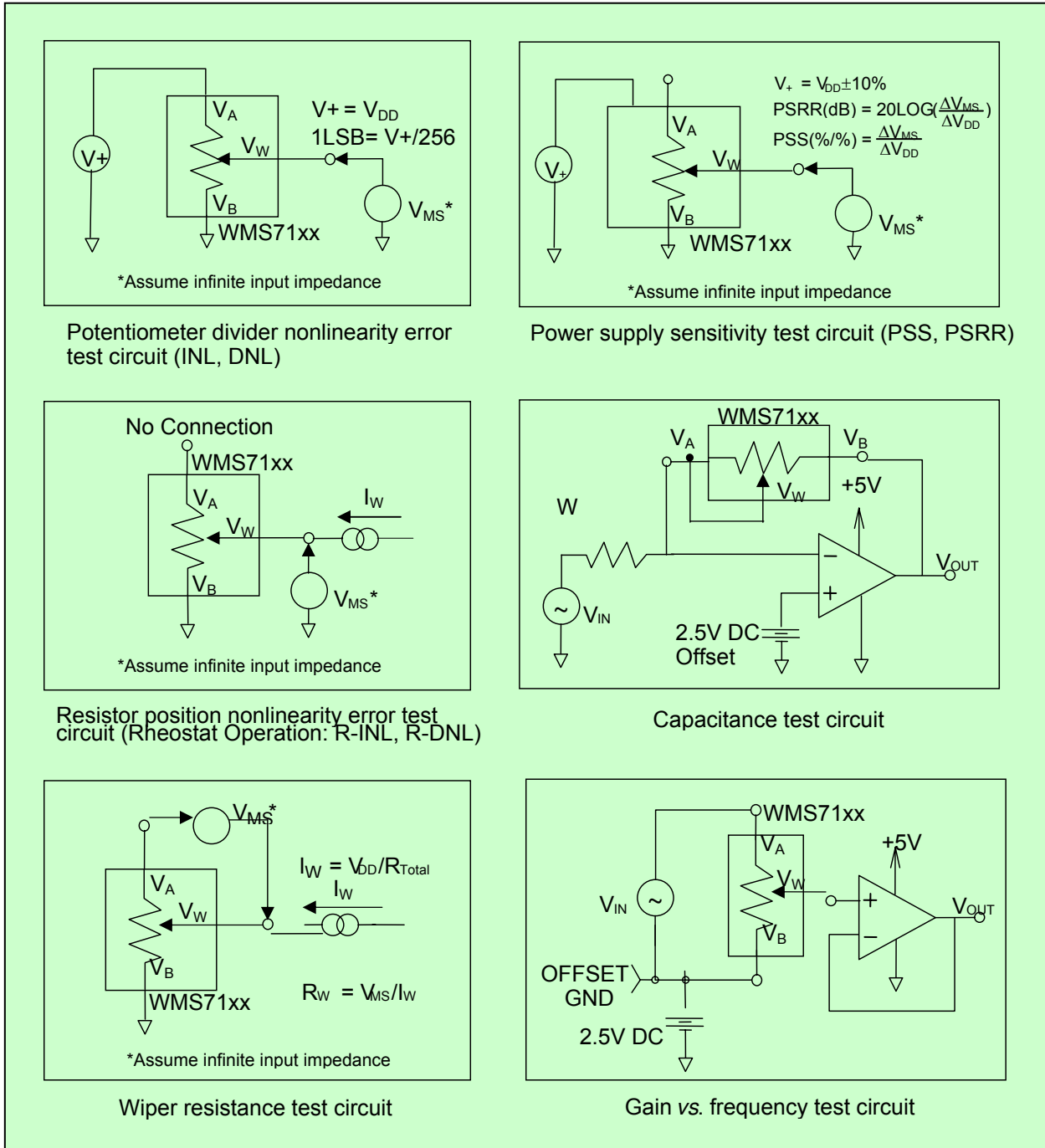

FIGURE 4 – TEST CIRCUITS



11. TYPICAL APPLICATION CIRCUITS

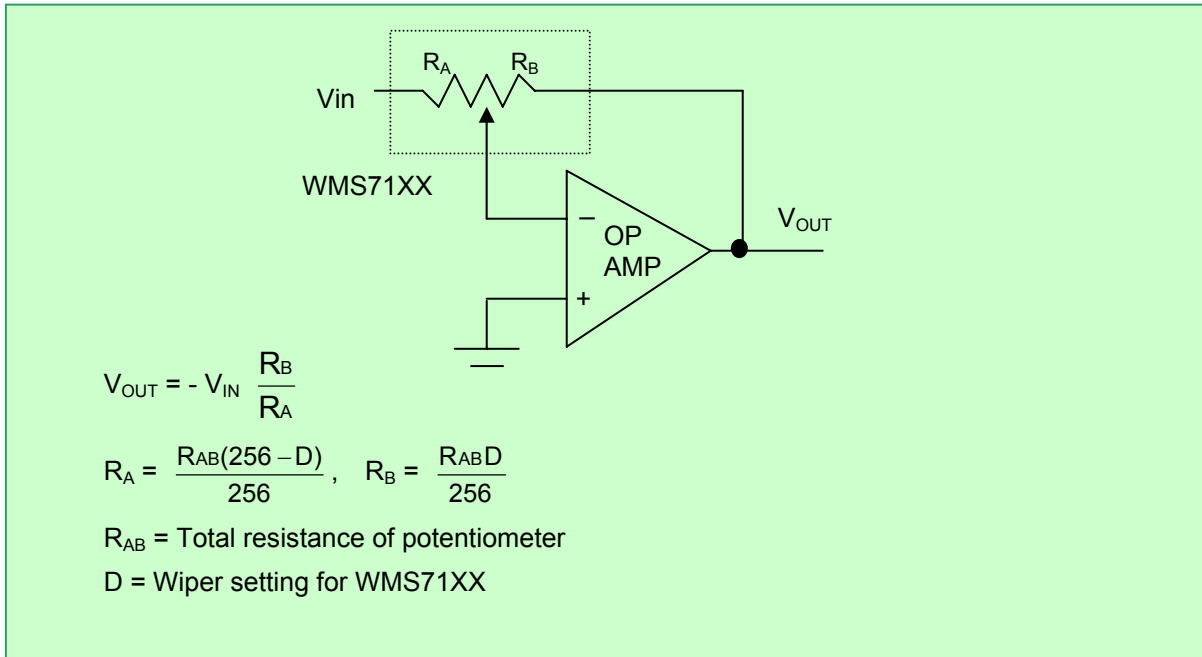

FIGURE 5 – PROGRAMMABLE INVERTING GAIN AMPLIFIER USING THE WMS7120/1

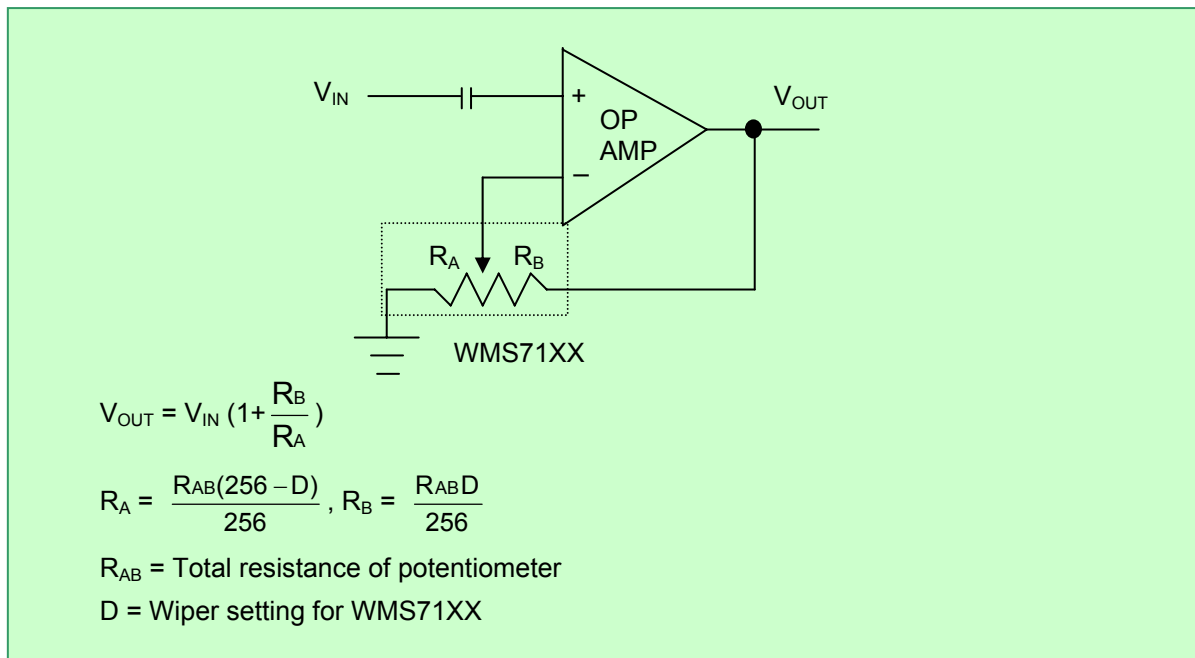

FIGURE 6 – PROGRAMMABLE NON-INVERTING GAIN AMPLIFIER USING THE WMS7120/1

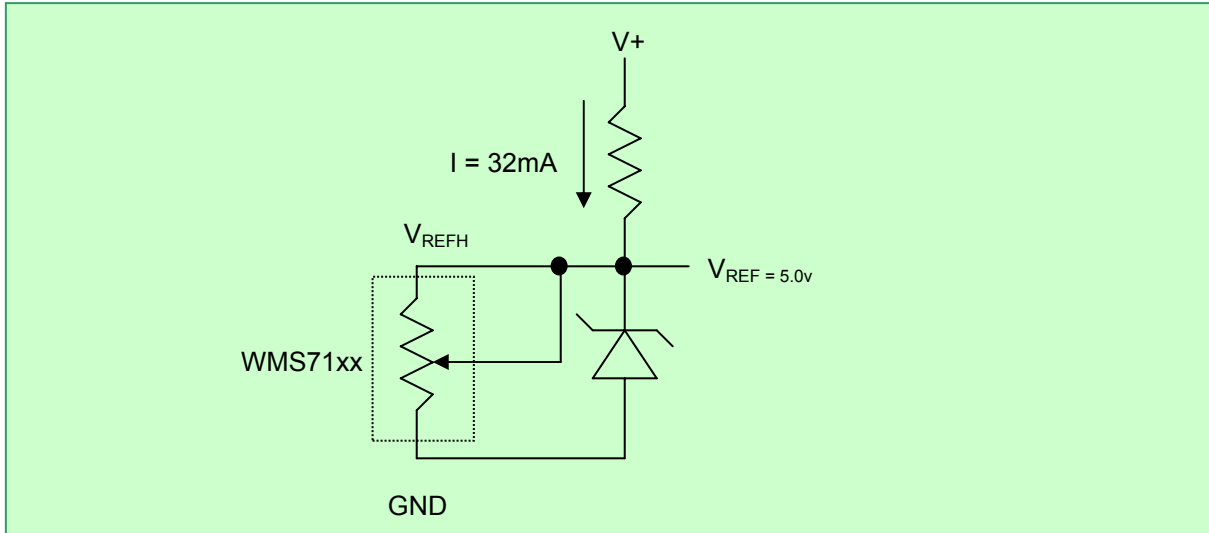

FIGURE 7 – WMS7120/1 TRIMMING VOLTAGE REFERENCE

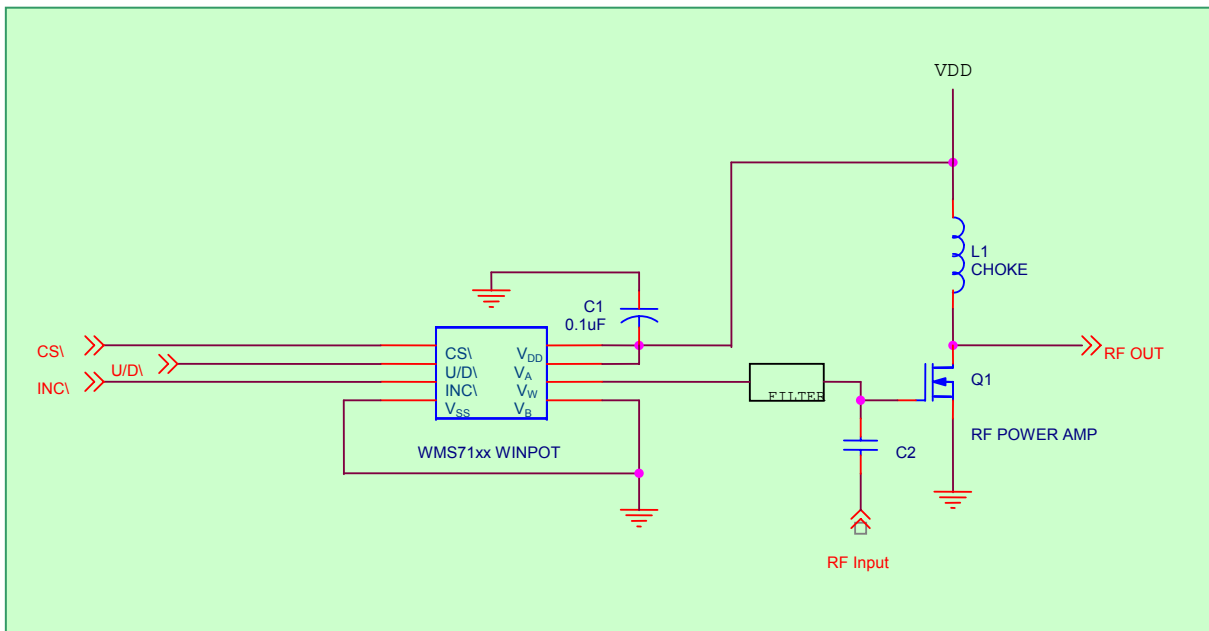

FIGURE 8 – WMS7120/1 RF AMP CONTROL



11.1. LAYOUT CONSIDERATIONS

Use a 0.1 μ F bypass capacitor as close as possible to the V_{DD} pin. This is recommended for best performance. Often this can be done by placing the surface mount capacitor on the bottom side of the PC board, directly between the V_{DD} and V_{SS} pins. Care should be taken to separate the analog and digital traces. Sensitive traces should not run under the device or close to the bypass capacitors.

A dedicated plane for analog ground helps in reducing ground noise for sensitive analog signals.

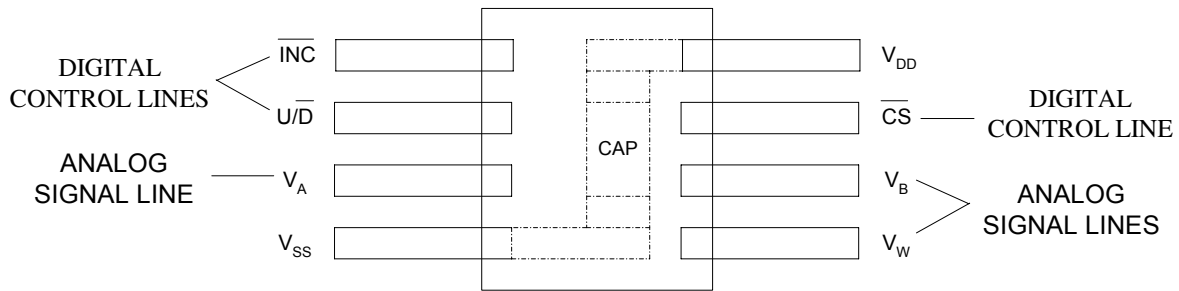

FIGURE 9 – WMS7120/1 LAYOUT



12. PACKAGE DRAWINGS AND DIMENSIONS

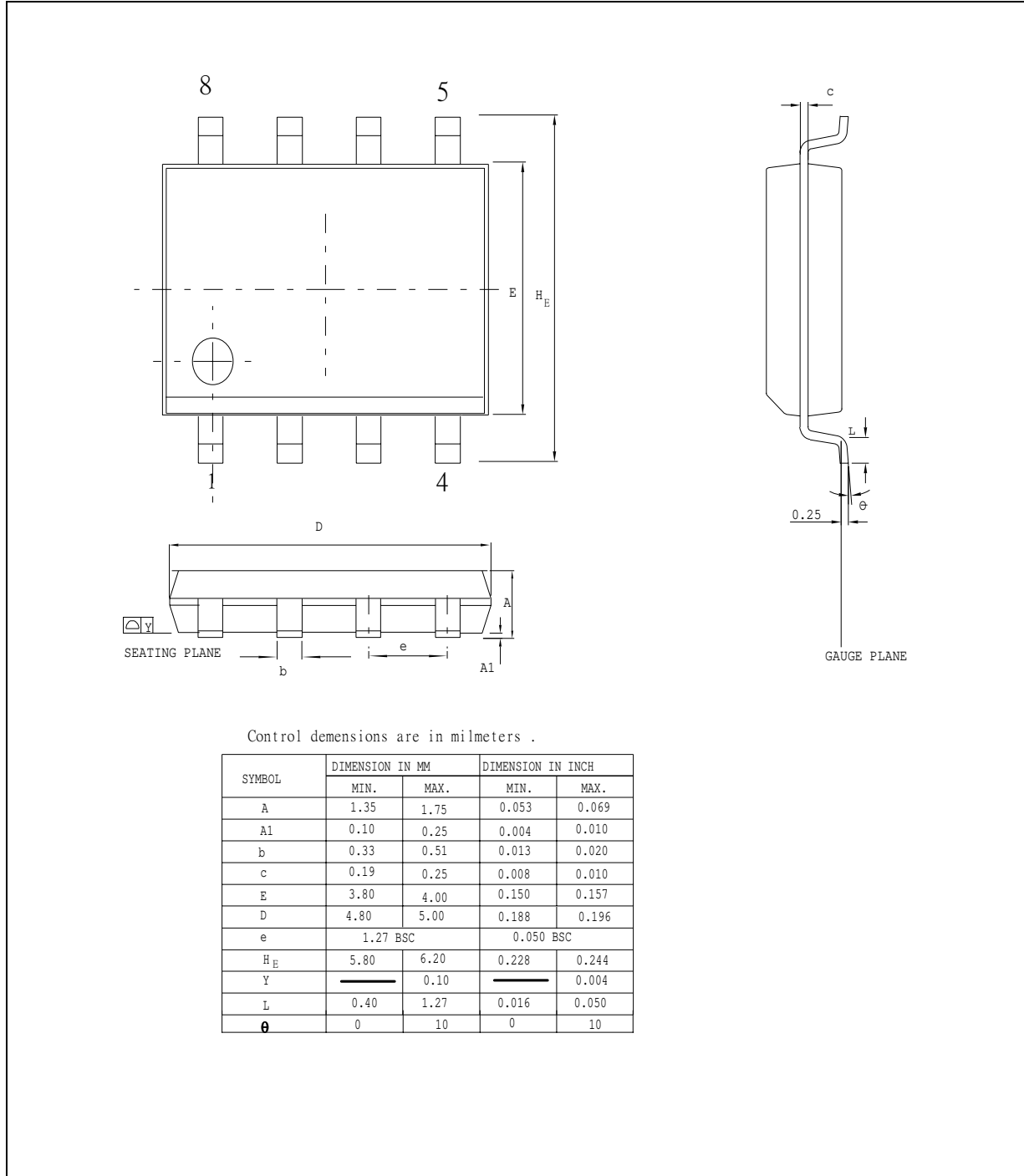

FIGURE 10: 8L 150MIL SOIC

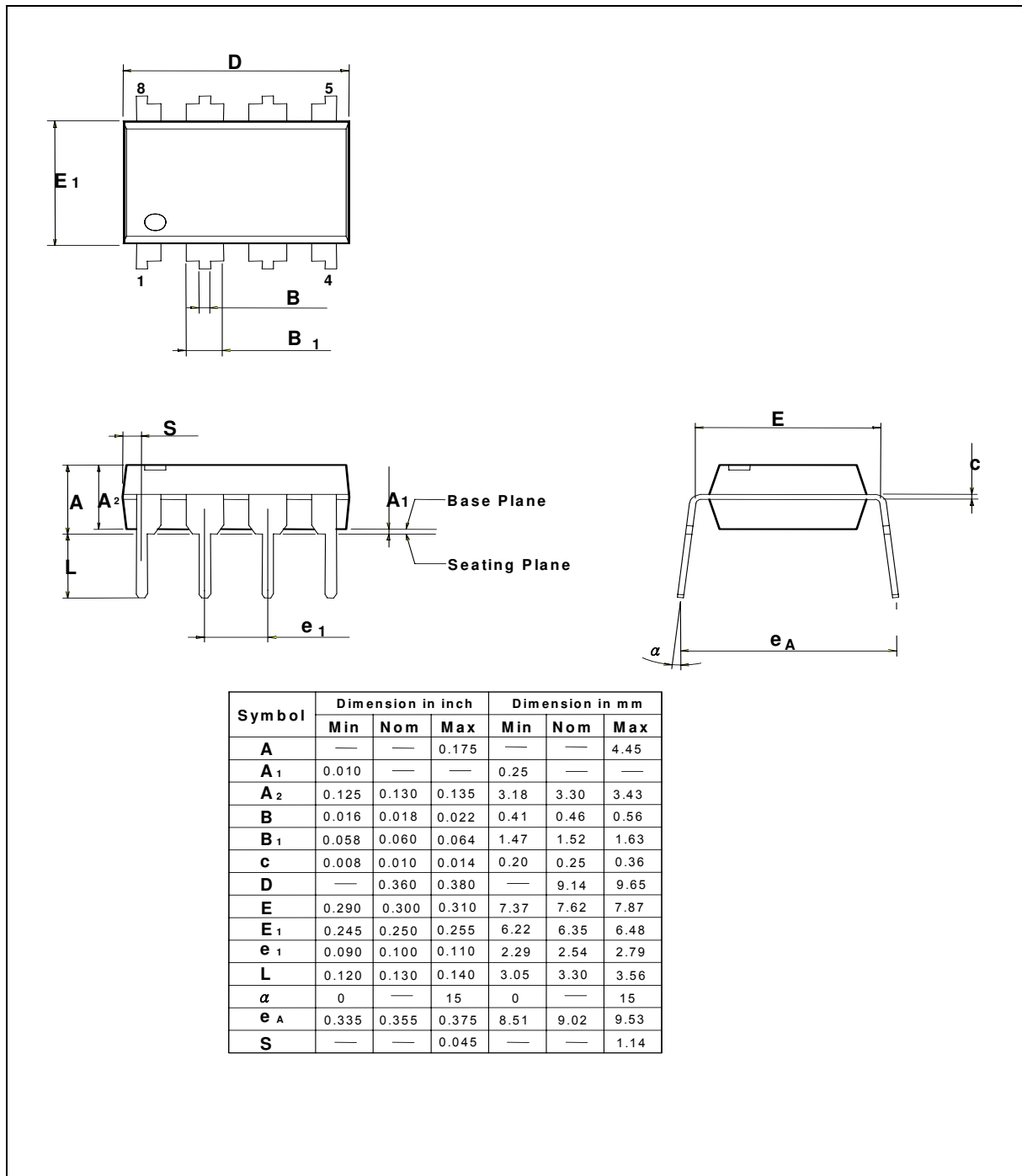

FIGURE 11: 8L 300MIL PDIP

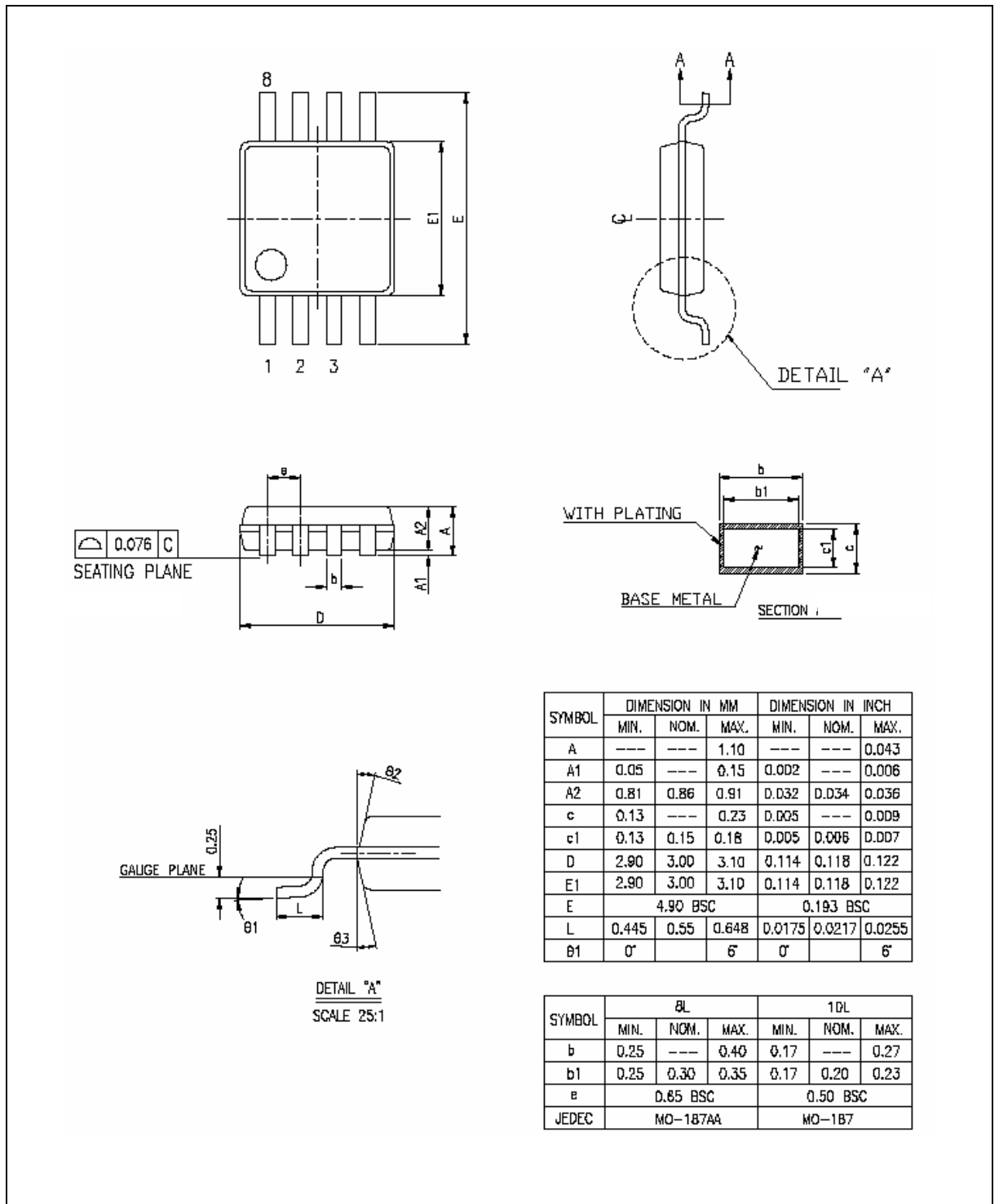
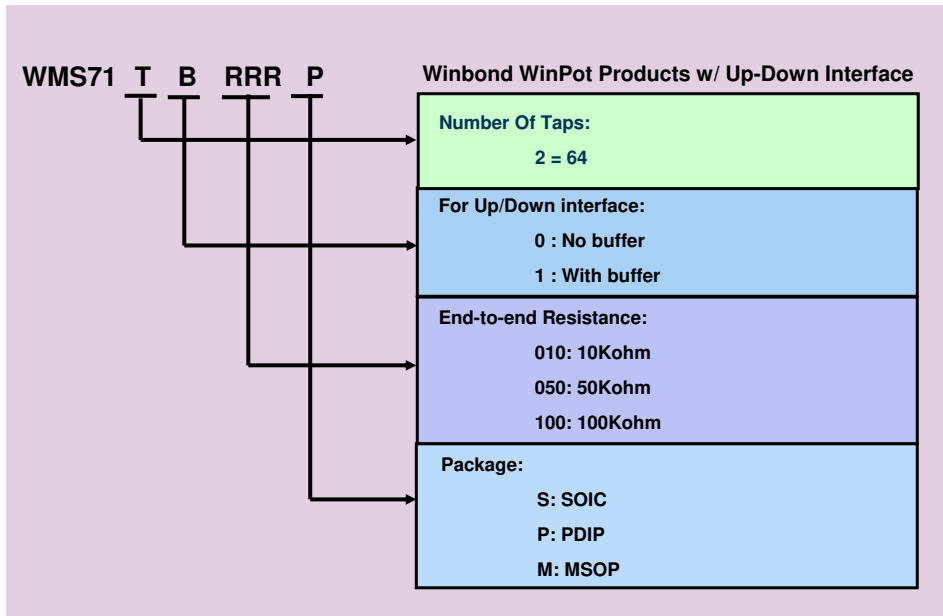

FIGURE 12: 8L 3MM MSOP



13. ORDERING INFORMATION

Winbond's WinPot Part Number Description:



Output Buffer	End-to-End Resistance	SOIC	PDIP	MSOP
NO	10K	WMS7120010S	WMS7120010P	WMS7120010M
	50K	WMS7120050S	WMS7120050P	WMS7120050M
	100K	WMS7120100S	WMS7120100P	WMS7120100M
YES	10K	WMS7121010S	WMS7121010P	WMS7121010M
	50K	WMS7121050S	WMS7121050P	WMS7121050M
	100K	WMS7121100S	WMS7121100P	WMS7121100M

Notes:

Part number with white background: Available for sampling and mass production.

Part numbers with shaded background: Call factory for availability.

For the latest product information, access Winbond's worldwide website at <http://www.winbond-usa.com>



14. VERSION HISTORY

VERSION	DATE	DESCRIPTION
1.0	June 2003	Initial issue
1.1	April 2005	Revise disclaim section



Winbond products are not designed, intended, authorized or warranted for use as components in systems or equipment intended for surgical implantation, atomic energy control instruments, airplane or spaceship instruments, transportation instruments, traffic signal instruments, combustion control instruments, or for other applications intended to support or sustain life. Furthermore, Winbond products are not intended for applications wherein failure of Winbond products could result or lead to a situation wherein personal injury, death or severe property or environmental damage could occur.

Winbond customers using or selling these products for use in such applications do so at their own risk and agree to fully indemnify Winbond for any damages resulting from such improper use or sales.

The contents of this document are provided only as a guide for the applications of Winbond products. Winbond makes no representation or warranties with respect to the accuracy or completeness of the contents of this publication and reserves the right to discontinue or make changes to specifications and product descriptions at any time without notice. No license, whether express or implied, to any intellectual property or other right of Winbond or others is granted by this publication. Except as set forth in Winbond's Standard Terms and Conditions of Sale, Winbond assumes no liability whatsoever and disclaims any express or implied warranty of merchantability, fitness for a particular purpose or infringement of any Intellectual property.

The contents of this document are provided "AS IS", and Winbond assumes no liability whatsoever and disclaims any express or implied warranty of merchantability, fitness for a particular purpose or infringement of any Intellectual property. In no event, shall Winbond be liable for any damages whatsoever (including, without limitation, damages for loss of profits, business interruption, loss of information) arising out of the use of or inability to use the contents of this documents, even if Winbond has been advised of the possibility of such damages.

Application examples and alternative uses of any integrated circuit contained in this publication are for illustration only and Winbond makes no representation or warranty that such applications shall be suitable for the use specified.

The 100-year retention and 100K record cycle projections are based upon accelerated reliability tests, as published in the Winbond Reliability Report, and are neither warranted nor guaranteed by Winbond. This product incorporates SuperFlash®.

This datasheet and any future addendum to this datasheet is(are) the complete and controlling ISD® ChipCorder® product specifications. In the event any inconsistencies exist between the information in this and other product documentation, or in the event that other product documentation contains information in addition to the information in this, the information contained herein supersedes and governs such other information in its entirety. This datasheet is subject to change without notice.

Copyright© 2005, Winbond Electronics Corporation. All rights reserved. ChipCorder® and ISD® are trademarks of Winbond Electronics Corporation. SuperFlash® is the trademark of Silicon Storage Technology, Inc. All other trademarks are properties of their respective owners.

*Please note that all data and specifications are subject to change without notice.
All the trademarks of products and companies mentioned in this datasheet belong to their respective owners.*