



Quad Digitally Programmable Potentiometers (DPP™) with 64 Taps and SPI Interface



FEATURES

- Four linear taper digitally programmable potentiometers
- 64 resistor taps per potentiometer
- End to end resistance 2.5kΩ, 10kΩ, 50kΩ or 100kΩ
- Potentiometer control and memory access via SPI interface: Mode (0, 0) and (1, 1)
- Low wiper resistance, typically 100Ω
- Nonvolatile memory storage for up to four wiper settings for each potentiometer
- Automatic recall of saved wiper settings at power up
- 2.5 to 6.0 volt operation
- Standby current less than 1μA
- 1,000,000 nonvolatile WRITE cycles
- 100 year nonvolatile memory data retention
- 24-lead SOIC and 24-lead TSSOP
- Industrial temperature range

For Ordering Information details, see page 14.

DESCRIPTION

The CAT5401 is four Digitally Programmable Potentiometers (DPPs™) integrated with control logic and 16 bytes of NVRAM memory. Each DPP consists of a series of 63 resistive elements connected between two externally accessible end points. The tap points between each resistive element are connected to the wiper outputs with CMOS switches. A separate 6-bit control register (WCR) independently controls the wiper tap switches for each DPP. Associated with each wiper control register are four 6-bit non-volatile memory data registers (DR) used for storing up to four wiper settings. Writing to the wiper control register or any of the non-volatile data registers is via a SPI serial bus. On power-up, the contents of the first data register (DR0) for each of the four potentiometers is automatically loaded into its respective wiper control register.

The CAT5401 can be used as a potentiometer or as a two terminal, variable resistor. It is intended for circuit level or system level adjustments in a wide variety of applications.

PIN CONFIGURATION

| SOIC Package (W) | | | | TSSOP Package (Y) | | | |
|------------------|----|----|------|-------------------|----|----|-----|
| VCC | 1 | 24 | NC | SI | 1 | 24 | WP |
| RL0 | 2 | 23 | RL3 | A1 | 2 | 23 | CS |
| RH0 | 3 | 22 | RH3 | RL1 | 3 | 22 | RW0 |
| RW0 | 4 | 21 | RW3 | RH1 | 4 | 21 | RH0 |
| CS | 5 | 20 | A0 | RW1 | 5 | 20 | RL0 |
| WP | 6 | 19 | SO | GND | 6 | 19 | VCC |
| SI | 7 | 18 | HOLD | NC | 7 | 18 | NC |
| A1 | 8 | 17 | SCK | RW2 | 8 | 17 | RL3 |
| RL1 | 9 | 16 | RL2 | RH2 | 9 | 16 | RH3 |
| RH1 | 10 | 15 | RH2 | RL2 | 10 | 15 | RW3 |
| RW1 | 11 | 14 | RW2 | SCK | 11 | 14 | A0 |
| GND | 12 | 13 | NC | HOLD | 12 | 13 | SO |

FUNCTIONAL DIAGRAM

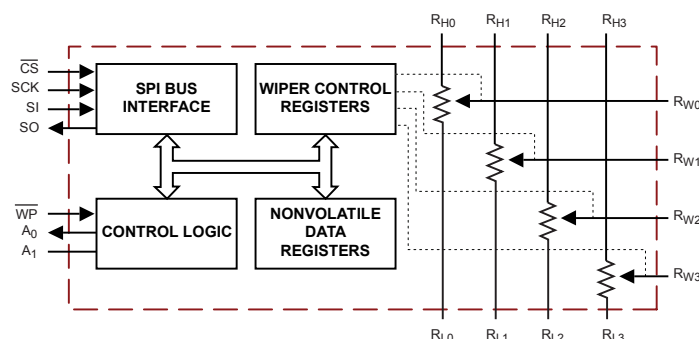

PIN DESCRIPTIONS

| Pin# (SOIC) | Pin# (TSSOP) | Name | Function |
|-------------|--------------|--------------------------|---|
| 1 | 19 | V _{CC} | Supply Voltage |
| 2 | 20 | R _{L0} | Low Reference Terminal for Potentiometer 0 |
| 3 | 21 | R _{H0} | High Reference Terminal for Potentiometer 0 |
| 4 | 22 | R _{W0} | Wiper Terminal for Potentiometer 0 |
| 5 | 23 | $\overline{\text{CS}}$ | Chip Select |
| 6 | 24 | $\overline{\text{WP}}$ | Write Protection |
| 7 | 1 | SI | Serial Input |
| 8 | 2 | A1 | Device Address |
| 9 | 3 | R _{L1} | Low Reference Terminal for Potentiometer 1 |
| 10 | 4 | R _{H1} | High Reference Terminal for Potentiometer 1 |
| 11 | 5 | R _{W1} | Wiper Terminal for Potentiometer 1 |
| 12 | 6 | GND | Ground |
| 13 | 7 | NC | No Connect |
| 14 | 8 | R _{W2} | Wiper Terminal for Potentiometer 2 |
| 15 | 9 | R _{H2} | High Reference Terminal for Potentiometer 2 |
| 16 | 10 | R _{L2} | Low Reference Terminal for Potentiometer 2 |
| 17 | 11 | SCK | Bus Serial Clock |
| 18 | 12 | $\overline{\text{HOLD}}$ | Hold |
| 19 | 13 | SO | Serial Data Output |
| 20 | 14 | A0 | Device Address, LSB |
| 21 | 15 | R _{W3} | Wiper Terminal for Potentiometer 3 |
| 22 | 16 | R _{H3} | High Reference Terminal for Potentiometer 3 |
| 23 | 17 | R _{L3} | Low Reference Terminal for Potentiometer 3 |
| 24 | 18 | NC | No Connect |

SI: Serial Input

SI is the serial data input pin. This pin is used to input all opcodes, byte addresses and data to be written to the CAT5401. Input data is latched on the rising edge of the serial clock.

SO: Serial Output

SO is the serial data output pin. This pin is used to transfer data out of the CAT5401. During a read cycle, data is shifted out on the falling edge of the serial clock.

SCK: Serial Clock

SCK is the serial clock pin. This pin is used to synchronize the communication between the microcontroller and the CAT5401. Opcodes, byte addresses or data present on the SI pin are latched on the rising edge of the SCK. Data on the SO pin is updated on the falling edge of the SCK.

A0, A1: Device Address Inputs

These inputs set the device address when addressing multiple devices. A total of four devices can be addressed on a single bus. A match in the slave address must be made with the address input in order to initiate communication with the CAT5401.

R_H, R_L: Resistor End Points

The four sets of R_H and R_L pins are equivalent to the terminal connections on a mechanical potentiometer.

R_W: Wiper

The four R_W pins are equivalent to the wiper terminal of a mechanical potentiometer.

 $\overline{\text{CS}}$: Chip Select

$\overline{\text{CS}}$ is the Chip select pin. $\overline{\text{CS}}$ low enables the CAT5401 and $\overline{\text{CS}}$ high disables the CAT5401. $\overline{\text{CS}}$ high takes the SO output pin to high impedance and forces the devices into a Standby mode (unless an internal write operation is underway). The CAT5401 draws ZERO current in the Standby mode. A high to low transition on $\overline{\text{CS}}$ is required prior to any sequence being initiated. A low to high transition on $\overline{\text{CS}}$ after a valid write sequence is what initiates an internal write cycle.

 $\overline{\text{WP}}$: Write Protect

$\overline{\text{WP}}$ is the Write Protect pin. The Write Protect pin will allow normal read/write operations when held high. When $\overline{\text{WP}}$ is tied low, all non-volatile write operations to the Data registers are inhibited (change of wiper control register is allowed). $\overline{\text{WP}}$ going low while $\overline{\text{CS}}$ is still low will interrupt a write to the registers. If the internal write cycle has already been initiated, $\overline{\text{WP}}$ going low will have no effect on any write operation.

 $\overline{\text{HOLD}}$: Hold

The $\overline{\text{HOLD}}$ pin is used to pause transmission to the CAT5401 while in the middle of a serial sequence without having to retransmit entire sequence at a later time. To pause, $\overline{\text{HOLD}}$ must be brought low while SCK is low. The SO pin is in a high impedance state during the time the part is paused, and transitions on the SI pins will be ignored. To resume communication, $\overline{\text{HOLD}}$ is brought high, while SCK is low. ($\overline{\text{HOLD}}$ should be held high any time this function is not being used.) $\overline{\text{HOLD}}$ may be tied high directly to V_{CC} or tied to V_{CC} through a resistor.

SERIAL BUS PROTOCOL

The CAT5401 supports the SPI bus data transmission protocol. The synchronous Serial Peripheral Interface (SPI) helps the CAT5401 to interface directly with many of today's popular microcontrollers. The CAT5401 contains an 8-bit instruction register. The instruction set and the operation codes are detailed in the instruction set table 3.

After the device is selected with \overline{CS} going low the first byte will be received. The part is accessed via the SI pin, with data being clocked in on the rising edge of SCK. The first byte contains one of the six op-codes that define the operation to be performed.

DEVICE OPERATION

The CAT5401 is four resistor arrays integrated with SPI serial interface logic, four 6-bit wiper control registers and sixteen 6-bit, non-volatile memory data registers. Each resistor array contains 63 separate resistive elements connected in series. The physical ends of each array are equivalent to the fixed terminals of a mechanical potentiometer (R_H and R_L). R_H and R_L are symmetrical and may be interchanged. The tap positions between and at the ends of the series resistors are connected to the output wiper terminals (R_W) by a CMOS transistor switch. Only one

tap point for each potentiometer is connected to its wiper terminal at a time and is determined by the value of the wiper control register. Data can be read or written to the wiper control registers or the non-volatile memory data registers via the SPI bus. Additional instructions allows data to be transferred between the wiper control registers and each respective potentiometer's non-volatile data registers. Also, the device can be instructed to operate in an "increment/decrement" mode.

Absolute Maximum Ratings⁽¹⁾

| Parameters | Ratings | Units |
|---|-------------------------|-------|
| Temperature Under Bias | -55 to +125 | °C |
| Storage Temperature | -65 to +150 | °C |
| Voltage on Any Pin with Respect to V_{SS} ⁽¹⁾⁽²⁾ | -2.0 to $+V_{CC} + 2.0$ | V |
| V_{CC} with Respect to Ground | -0.2 to +7.0 | V |
| Package Power Dissipation Capability ($T_A = 25^\circ\text{C}$) | 1.0 | W |
| Lead Soldering Temperature (10s) | 300 | °C |
| Wiper Current | ± 12 | mA |

Recommended Operating Conditions

| Parameters | Ratings | Units |
|------------------------|------------|-------|
| V_{CC} | +2.5 to +6 | V |
| Industrial Temperature | -40 to +85 | °C |

Potentiometer Characteristics

Over recommended operating conditions unless otherwise stated.

| Symbol | Parameter | Test Conditions | Min | Typ | Max | Units |
|---------------|--------------------------------------|---|-----|----------|----------|-----------------------|
| R_{POT} | Potentiometer Resistance (-00) | | | 100 | | k Ω |
| R_{POT} | Potentiometer Resistance (-50) | | | 50 | | k Ω |
| R_{POT} | Potentiometer Resistance (-10) | | | 10 | | k Ω |
| R_{POT} | Potentiometer Resistance (-2.5) | | | 2.5 | | k Ω |
| | Potentiometer Resistance Tolerance | | | | ± 20 | % |
| | R_{POT} Matching | | | | 1 | % |
| | Power Rating | 25°C, each pot | | | 50 | mW |
| I_W | Wiper Current | | | | +3 | mA |
| R_W | Wiper Resistance | $I_W = \pm 3\text{mA} @ V_{CC} = 3\text{V}$ | | 200 | 300 | Ω |
| R_W | Wiper Resistance | $I_W = \pm 3\text{mA} @ V_{CC} = 5\text{V}$ | | 100 | 150 | Ω |
| V_{TERM} | Voltage on any R_H or R_L Pin | $V_{SS} = 0\text{V}$ | GND | | V_{CC} | V |
| V_N | Noise | (4) | | | | nV $\sqrt{\text{Hz}}$ |
| | Resolution | | | 0.4 | | % |
| | Absolute Linearity ⁽⁵⁾ | $R_W(n)(\text{actual}) - R(n)(\text{expected})^{(8)}$ | | | +1 | LSB ⁽⁷⁾ |
| | Relative Linearity ⁽⁶⁾ | $R_W(n+1) - [R_W(n) + \text{LSB}]^{(8)}$ | | | +0.2 | LSB ⁽⁷⁾ |
| TC_{RPOT} | Temperature Coefficient of R_{POT} | (4) | | +300 | | ppm/°C |
| TC_{RATIO} | Ratiometric Temp. Coefficient | (4) | | | 20 | ppm/°C |
| $C_H/C_L/C_W$ | Potentiometer Capacitances | (4) | | 10/10/25 | | pF |
| fc | Frequency Response | $R_{POT} = 50\text{k}\Omega$ ⁽⁴⁾ | | 0.4 | | MHz |

Notes:

- (1) Stresses above those listed under “Absolute Maximum Ratings” may cause permanent damage to the device. These are stress ratings only, and functional operation of the device at these or any other conditions outside of those listed in the operational sections of this specification is not implied. Exposure to any absolute maximum rating for extended periods may affect device performance and reliability.
- (2) The minimum DC input voltage is -0.5V. During transitions, inputs may undershoot to -2.0V for periods of less than 20ns. Maximum DC voltage on output pins is $V_{CC} + 0.5\text{V}$, which may overshoot to $V_{CC} + 2.0\text{V}$ for periods of less than 20ns.
- (3) Latch-up protection is provided for stresses up to 100mA on address and data pins from -1V to $V_{CC} + 1\text{V}$.
- (4) This parameter is tested initially and after a design or process change that affects the parameter.
- (5) Absolute linearity is utilized to determine actual wiper voltage versus expected voltage as determined by wiper position when used as a potentiometer.
- (6) Relative linearity is utilized to determine the actual change in voltage between two successive tap positions when used as a potentiometer. It is a measure of the error in step size.
- (7) $\text{LSB} = R_{TOT} / 63$ or $(R_H - R_L) / 63$, single pot
- (8) $n = 0, 1, 2, \dots, 63$

D.C. OPERATING CHARACTERISTICS

Over recommended operating conditions unless otherwise stated.

| Symbol | Parameter | Test Conditions | Min | Max | Units |
|-----------|---|---|---------------------|---------------------|---------------|
| I_{CC} | Power Supply Current | $f_{SCL} = 2\text{MHz}$, SO = Open Inputs = GND | | 1 | mA |
| I_{SB} | Standby Current ($V_{CC} = 5.0\text{V}$) | $V_{IN} = \text{GND}$ or V_{CC} , SO = Open | | 1 | μA |
| I_{LI} | Input Leakage Current | $V_{IN} = \text{GND}$ to V_{CC} | | 10 | μA |
| I_{LO} | Output Leakage Current | $V_{OUT} = \text{GND}$ to V_{CC} | | 10 | μA |
| V_{IL} | Input Low Voltage | | -1 | $V_{CC} \times 0.3$ | V |
| V_{IH} | Input High Voltage | | $V_{CC} \times 0.7$ | $V_{CC} + 1.0$ | V |
| V_{OL1} | Output Low Voltage ($V_{CC} = 3.0\text{V}$) | $I_{OL} = 3\text{mA}$ | | 0.4 | V |

PIN Capacitance ⁽¹⁾

Available over recommended operating range from $T_A = 25^\circ\text{C}$, $f = 1.0\text{MHz}$, $V_{CC} = 5\text{V}$ (unless otherwise noted).

| Symbol | Test | Conditions | Max. | Units |
|-----------|---|-----------------------|------|-------|
| C_{OUT} | Output Capacitance (SO) | $V_{OUT} = 0\text{V}$ | 8 | pF |
| C_{IN} | Input Capacitance ($\overline{\text{CS}}$, SCK, SI, $\overline{\text{WP}}$, $\overline{\text{HOLD}}$) | $V_{IN} = 0\text{V}$ | 6 | pF |

A.C. CHARACTERISTICS

Over recommended operating conditions unless otherwise stated.

| Symbol | Parameter | Test Conditions | Min | Typ | Max | Units |
|----------------|---|---------------------|-----|-----|-----|---------------|
| t_{SU} | Data Setup Time | $C_L = 50\text{pF}$ | 50 | | | ns |
| t_H | Data Hold Time | | 50 | | | ns |
| t_{WH} | SCK High Time | | 125 | | | ns |
| t_{WL} | SCK Low Time | | 125 | | | ns |
| f_{SCK} | Clock Frequency | | DC | | 3 | MHz |
| t_{LZ} | $\overline{\text{HOLD}}$ to Output Low Z | | | | 50 | ns |
| $t_{RI}^{(1)}$ | Input Rise Time | | | | 2 | μs |
| $t_{FI}^{(1)}$ | Input Fall Time | | | | 2 | μs |
| t_{HD} | $\overline{\text{HOLD}}$ Setup Time | | 100 | | | ns |
| t_{CD} | $\overline{\text{HOLD}}$ Hold Time | | 100 | | | ns |
| t_{WC} | Write Cycle Time | | | | 10 | ms |
| t_V | Output Valid from Clock Low | | | | 250 | ns |
| t_{HO} | Output Hold Time | | 0 | | | ns |
| t_{DIS} | Output Disable Time | | | | 250 | ns |
| t_{HZ} | $\overline{\text{HOLD}}$ to Output High Z | | | | 100 | ns |
| t_{CS} | $\overline{\text{CS}}$ High Time | | 250 | | | ns |
| t_{CSS} | $\overline{\text{CS}}$ Setup Time | | 250 | | | ns |
| t_{CSH} | $\overline{\text{CS}}$ Hold Time | | 250 | | | ns |

Note:

(1) This parameter is tested initially and after a design or process change that affects the parameter.

Power Up Timing ⁽¹⁾⁽²⁾

| Symbol | Parameter | Max | Units |
|-----------|-----------------------------|-----|-------|
| t_{PUR} | Power-up to Read Operation | 1 | ms |
| t_{PUW} | Power-up to Write Operation | 1 | ms |

Write Cycle Limits

| Symbol | Parameter | Max | Units |
|----------|------------------|-----|-------|
| t_{WR} | Write Cycle Time | 5 | ms |

Reliability Characteristics

| Symbol | Parameter | Reference Test Method | Min | Max | Units |
|-----------------|--------------------|-------------------------------|-----------|-----|-------------|
| $N_{END}^{(3)}$ | Endurance | MIL-STD-883, Test Method 1033 | 1,000,000 | | Cycles/Byte |
| $T_{DR}^{(3)}$ | Data Retention | MIL-STD-883, Test Method 1008 | 100 | | Years |
| $V_{ZAP}^{(3)}$ | ESD Susceptibility | MIL-STD-883, Test Method 3015 | 2000 | | V |
| $I_{LTH}^{(3)}$ | Latch-Up | JEDEC Standard 17 | 100 | | mA |

Figure 1. Synchronous Data Timing

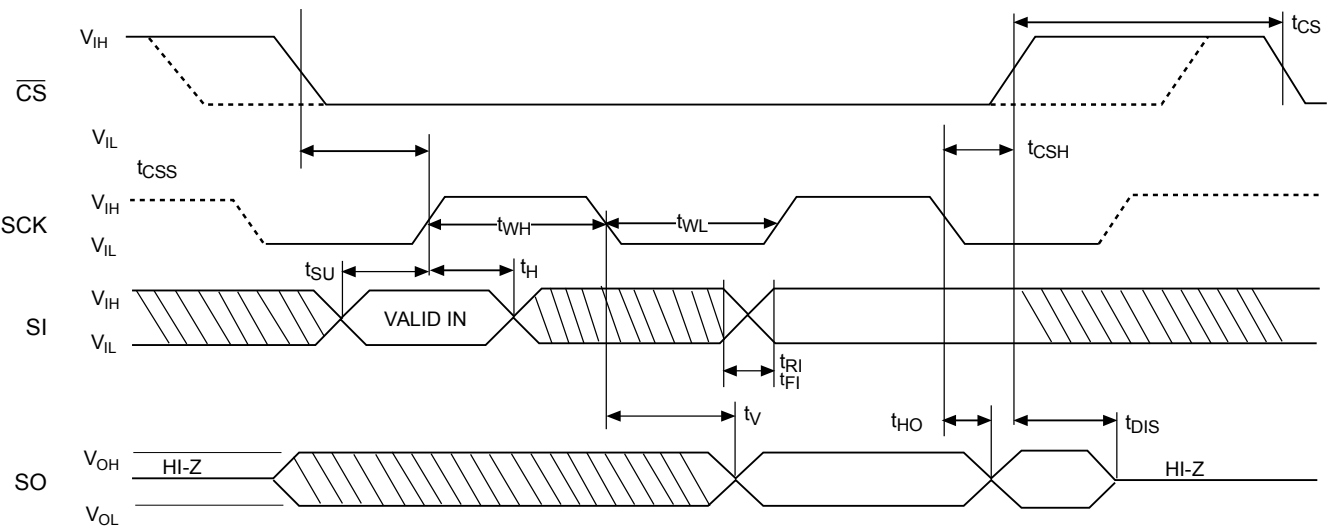
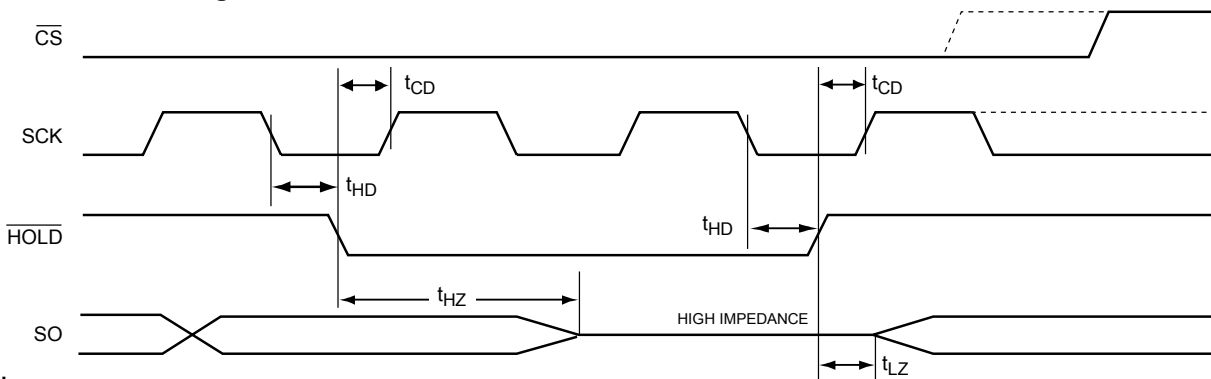

Figure 2. HOLD Timing



Notes:

- (1) This parameter is tested initially and after a design or process change that affects the parameter.
- (2) t_{PUR} and t_{PUW} are delays required from the time V_{CC} is stable until the specified operation can be initiated.
- (3) This parameter is tested initially and after a design or process change that affects the parameter.
- (4) Dashed Line = mode (1, 1) -----

INSTRUCTION AND REGISTER DESCRIPTION

DEVICE TYPE / ADDRESS BYTE

The first byte sent to the CAT5401 from the master/processor is called the Device Address Byte. The most significant four bits of the Device Type address are a device type identifier. These bits for the CAT5401 are fixed at 0101[B] (refer to Table 1).

The two least significant bits in the slave address byte, A1 - A0, are the internal slave address and must match the physical device address which is defined by the state of the A1 - A0 input pins for the CAT5401 to successfully continue the command sequence. Only the device which slave address matches the incoming device address sent by the master executes the instruction. The A1 - A0 inputs can be actively driven by CMOS input signals or tied to V_{CC} or V_{SS} . The remaining two bits in the device address must be set to 0.

INSTRUCTION BYTE

The next byte sent to the CAT5401 contains the instruction and register pointer information. The four most significant bits used provide the instruction opcode I [3:0]. The R1 and R0 bits point to one of the four data registers of each associated potentiometer. The least two significant bits point to one of four Wiper Control Registers. The format is shown in Table 2.

Data Register Selection

| Data Register Selected | R1 | R0 |
|------------------------|----|----|
| DR0 | 0 | 0 |
| DR1 | 0 | 1 |
| DR2 | 1 | 0 |
| DR3 | 1 | 1 |

Table 1. Identification Byte Format

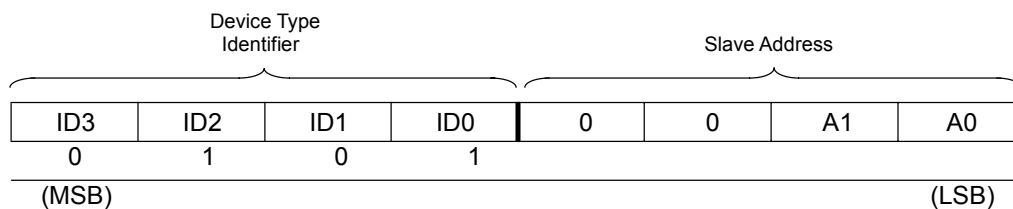
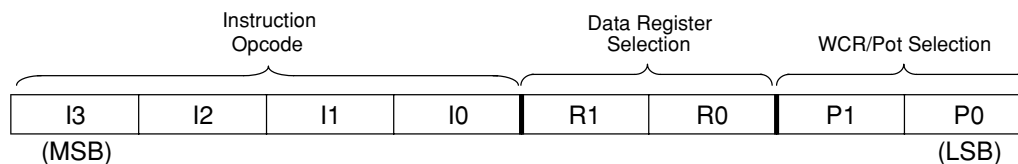

Table 2. Instruction Byte Format



Wiper Control and Data Registers

Wiper Control Register (WCR)

The CAT5401 contains four 6-bit Wiper Control Registers, one for each potentiometer. The Wiper Control Register output is decoded to select one of 64 switches along its resistor array. The contents of the WCR can be altered in four ways: it may be written by the host via Write Wiper Control Register instruction; it may be written by transferring the contents of one of four associated Data Registers via the XFR Data Register instruction, it can be modified one step at a time by the Increment/decrement instruction (see Instruction section for more details). Finally, it is loaded with the content of its data register zero (DR0) upon power-up.

The Wiper Control Register is a volatile register that loses its contents when the CAT5401 is powered-down. Although the register is automatically loaded with the value in DR0 upon power-up, this may be different from the value present at power-down.

Data Registers (DR)

Each potentiometer has four 6-bit non-volatile Data Registers. These can be read or written directly by the host. Data can also be transferred between any of the four Data Registers and the associated Wiper Control Register. Any data changes in one of the Data

Registers is a non-volatile operation and will take a maximum of 5ms.

Write in Process

The contents of the Data Registers are saved to nonvolatile memory when the CS input goes HIGH after a write sequence is received. The status of the internal write cycle can be monitored by issuing a Read Status command to read the Write in Process (WIP) bit.

Instructions

Four of the nine instructions are three bytes in length. These instructions are:

- **Read Wiper Control Register** – read the current wiper position of the selected potentiometer in the WCR
- **Write Wiper Control Register** – change current wiper position in the WCR of the selected potentiometer
- **Read Data Register** – read the contents of the selected Data Register
- **Write Data Register** – write a new value to the selected Data Register
- **Read Status** – Read the status of the WIP bit which when set to "1" signifies a write cycle is in progress.

Table 3. Instruction Set

Note: 1/0 = data is one or zero

| Instruction | Instruction Set | | | | | | | | Operation |
|--|-----------------|----|----|----|-----|-----|----------|----------|---|
| | I3 | I2 | I1 | I0 | R1 | R0 | WCR1/ P1 | WCR0/ P0 | |
| Read Wiper Control Register | 1 | 0 | 0 | 1 | 0 | 0 | 1/0 | 1/0 | Read the contents of the Wiper Control Register pointed to by P1-P0 |
| Write Wiper Control Register | 1 | 0 | 1 | 0 | 0 | 0 | 1/0 | 1/0 | Write new value to the Wiper Control Register pointed to by P1-P0 |
| Read Data Register | 1 | 0 | 1 | 1 | 1/0 | 1/0 | 1/0 | 1/0 | Read the contents of the Data Register pointed to by P1-P0 and R1-R0 |
| Write Data Register | 1 | 1 | 0 | 0 | 1/0 | 1/0 | 1/0 | 1/0 | Write new value to the Data Register pointed to by P1-P0 and R1-R0 |
| XFR Data Register to Wiper Control Register | 1 | 1 | 0 | 1 | 1/0 | 1/0 | 1/0 | 1/0 | Transfer the contents of the Data Register pointed to by P1-P0 and R1-R0 to its associated Wiper Control Register |
| XFR Wiper Control Register to Data Register | 1 | 1 | 1 | 0 | 1/0 | 1/0 | 1/0 | 1/0 | Transfer the contents of the Wiper Control Register pointed to by P1-P0 to the Data Register pointed to by R1-R0 |
| Global XFR Data Registers to Wiper Control Registers | 0 | 0 | 0 | 1 | 1/0 | 1/0 | 0 | 0 | Transfer the contents of the Data Registers pointed to by R1-R0 of all four pots to their respective Wiper Control Registers |
| Global XFR Wiper Control Registers to Data Register | 1 | 0 | 0 | 0 | 1/0 | 1/0 | 0 | 0 | Transfer the contents of both Wiper Control Registers to their respective data Registers pointed to by R1-R0 of all four pots |
| Increment/Decrement Wiper Control Register | 0 | 0 | 1 | 0 | 0 | 0 | 1/0 | 1/0 | Enable Increment/decrement of the Control Latch pointed to by P1-P0 |
| Read Status (WIP bit) | 0 | 1 | 0 | 1 | 0 | 0 | 0 | 1 | Read WIP bit to check internal write cycle status |

The basic sequence of the three byte instructions is illustrated in Figure 4. These three-byte instructions exchange data between the WCR and one of the Data Registers. The WCR controls the position of the wiper. The response of the wiper to this action will be delayed by t_{WRL} . A transfer from the WCR (current wiper position), to a Data Register is a write to non-volatile memory and takes a minimum of t_{WR} to complete. The transfer can occur between one of the four potentiometers and one of its associated registers; or the transfer can occur between all potentiometers and one associated register.

Four instructions require a two-byte sequence to complete, as illustrated in Figure 3. These instructions transfer data between the host/processor and the CAT5401; either between the host and one of the data registers or directly between the host and the Wiper Control Register. These instructions are:

- **XFR Data Register to Wiper Control Register**
This transfers the contents of one specified Data Register to the associated Wiper Control Register.
- **XFR Wiper Control Register to Data Register**
This transfers the contents of the specified Wiper Control Register to the specified associated Data Register.

- **Gang XFR Data Register to Wiper Control Register**
This transfers the contents of all specified Data Registers to the associated Wiper Control Registers.
- **Gang XFR Wiper Counter Register to Data Register**
This transfers the contents of all Wiper Control Registers to the specified associated Data Registers.

Increment/Decrement Command

The final command is Increment/Decrement (Figure 5). The Increment/Decrement command is different from the other commands. Once the command is issued the master can clock the selected wiper up and/or down in one segment steps; thereby providing a fine tuning capability to the host. For each SCK clock pulse (t_{HIGH}) while SI is HIGH, the selected wiper will move one resistor segment towards the R_H terminal. Similarly, for each SCK clock pulse while SI is LOW, the selected wiper will move one resistor segment towards the R_L terminal.

See Instructions format for more detail.

Figure 3. Two-Byte Instruction Sequence

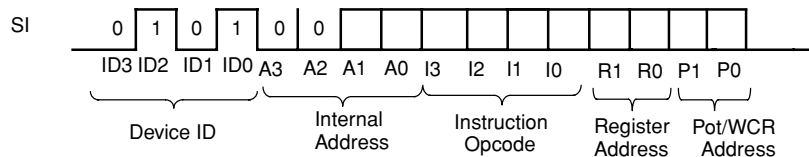

Figure 4. Three-Byte Instruction Sequence

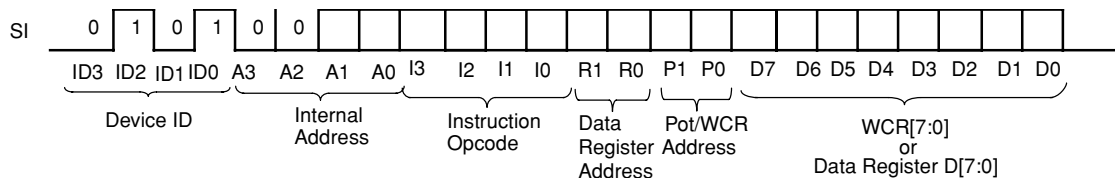

Figure 5. Increment/Decrement Instruction Sequence

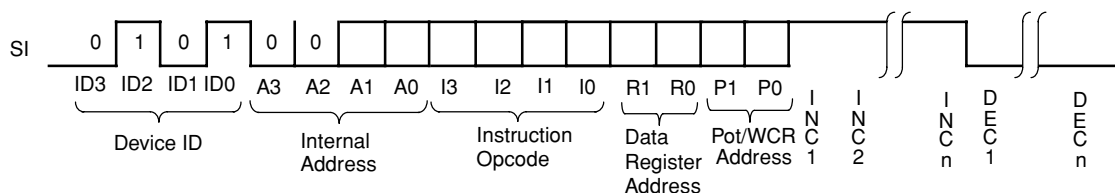
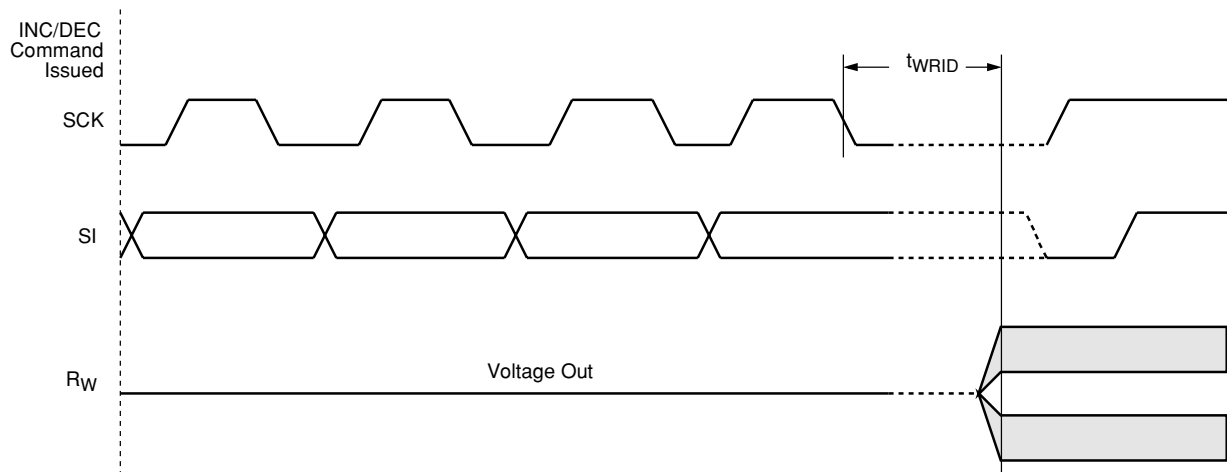

Figure 6. Increment/Decrement Timing Limits



INSTRUCTION FORMAT

Read Wiper Control Register (WCR)

| CS | DEVICE ADDRESSES | | | | | | | INSTRUCTION | | | | | | DATA | | | | | | | | CS | | | |
|----|------------------|---|---|---|---|---|----|-------------|---|---|---|---|---|------|----|----|---|---|---|---|---|----|---|---|---|
| | 0 | 1 | 0 | 1 | 0 | 0 | A1 | A0 | 1 | 0 | 0 | 1 | 0 | 0 | P1 | P0 | 7 | 6 | 5 | 4 | 3 | | 2 | 1 | 0 |
| | | | | | | | | | | | | | | | | | | | | | | | | | |

Write Wiper Control Register (WCR)

| CS | DEVICE ADDRESSES | | | | | | | INSTRUCTION | | | | | | DATA | | | | | | | | CS | | | |
|----|------------------|---|---|---|---|---|----|-------------|---|---|---|---|---|------|----|----|---|---|---|---|---|----|---|---|---|
| | 0 | 1 | 0 | 1 | 0 | 0 | A1 | A0 | 1 | 0 | 1 | 0 | 0 | 0 | P1 | P0 | 7 | 6 | 5 | 4 | 3 | | 2 | 1 | 0 |
| | | | | | | | | | | | | | | | | | | | | | | | | | |

Read Data Register (DR)

| CS | DEVICE ADDRESSES | | | | | | | INSTRUCTION | | | | | | DATA | | | | | | | | CS | | | |
|----|------------------|---|---|---|---|---|----|-------------|---|---|---|---|----|------|----|----|---|---|---|---|---|----|---|---|---|
| | 0 | 1 | 0 | 1 | 0 | 0 | A1 | A0 | 1 | 0 | 1 | 1 | R1 | R0 | P1 | P0 | 7 | 6 | 5 | 4 | 3 | | 2 | 1 | 0 |
| | | | | | | | | | | | | | | | | | | | | | | | | | |

Write Data Register (DR)

| CS | DEVICE ADDRESSES | | | | | | | INSTRUCTION | | | | | | DATA | | | | | | | | CS | High Voltage Write Cycle | | | |
|----|------------------|---|---|---|---|---|----|-------------|---|---|---|---|----|------|----|----|---|---|---|---|---|----|--------------------------|---|---|---|
| | 0 | 1 | 0 | 1 | 0 | 0 | A1 | A0 | 1 | 1 | 0 | 0 | R1 | R0 | P1 | P0 | 7 | 6 | 5 | 4 | 3 | | | 2 | 1 | 0 |
| | | | | | | | | | | | | | | | | | | | | | | | | | | |

Read (WIP) Status

| CS | DEVICE ADDRESSES | | | | | | | INSTRUCTION | | | | | | DATA | | | | | | | | CS | | | |
|----|------------------|---|---|---|---|---|----|-------------|---|---|---|---|---|------|---|---|---|---|---|---|---|----|---|---|-----|
| | 0 | 1 | 0 | 1 | 0 | 0 | A1 | A0 | 0 | 1 | 0 | 1 | 0 | 0 | 0 | 1 | 7 | 6 | 5 | 4 | 3 | | 2 | 1 | WIP |
| | | | | | | | | | | | | | | | | | | | | | | | | | |

INSTRUCTION FORMAT (continued)

Global Transfer Data Register (DR) to Wiper Control Register (WCR)

| \overline{CS} | DEVICE ADDRESSES | | | | | | | | INSTRUCTION | | | | | | \overline{CS} | | |
|-----------------|------------------|---|---|---|---|---|----|----|-------------|---|---|---|----|----|-----------------|---|---|
| | 0 | 1 | 0 | 1 | 0 | 0 | A1 | A0 | 0 | 0 | 0 | 1 | R1 | R0 | | 0 | 0 |
| | | | | | | | | | | | | | | | | | |

Global Transfer Wiper Control Register (WCR) to Data Register (DR)

| \overline{CS} | DEVICE ADDRESSES | | | | | | | | INSTRUCTION | | | | | | \overline{CS} | High Voltage Write Cycle | | |
|-----------------|------------------|---|---|---|---|---|----|----|-------------|---|---|---|----|----|-----------------|--------------------------|---|---|
| | 0 | 1 | 0 | 1 | 0 | 0 | A1 | A0 | 1 | 0 | 0 | 0 | R1 | R0 | | | 0 | 0 |
| | | | | | | | | | | | | | | | | | | |

Transfer Wiper Control Register (WCR) to Data Register (DR)

| \overline{CS} | DEVICE ADDRESSES | | | | | | | | INSTRUCTION | | | | | | \overline{CS} | High Voltage Write Cycle | | |
|-----------------|------------------|---|---|---|---|---|----|----|-------------|---|---|---|----|----|-----------------|--------------------------|----|----|
| | 0 | 1 | 0 | 1 | 0 | 0 | A1 | A0 | 1 | 1 | 1 | 0 | R1 | R0 | | | P1 | P0 |
| | | | | | | | | | | | | | | | | | | |

Transfer Data Register (DR) to Wiper Control Register (WCR)

| \overline{CS} | DEVICE ADDRESSES | | | | | | | | INSTRUCTION | | | | | | \overline{CS} | | |
|-----------------|------------------|---|---|---|---|---|----|----|-------------|---|---|---|----|----|-----------------|----|----|
| | 0 | 1 | 0 | 1 | 0 | 0 | A1 | A0 | 1 | 1 | 0 | 1 | R1 | R0 | | P1 | P0 |
| | | | | | | | | | | | | | | | | | |

Increment (I)/Decrement (D) Wiper Control Register (WCR)

| \overline{CS} | DEVICE ADDRESSES | | | | | | | | INSTRUCTION | | | | | | DATA | | | | \overline{CS} | | | |
|-----------------|------------------|---|---|---|---|---|----|----|-------------|---|---|---|---|---|------|----|-----|-----|-----------------|-----|-----|-----|
| | 0 | 1 | 0 | 1 | 0 | 0 | A1 | A0 | 0 | 0 | 1 | 0 | 0 | 0 | P1 | P0 | I/D | I/D | | ... | I/D | I/D |
| | | | | | | | | | | | | | | | | | | | | | | |

Note:

(1) Any write or transfer to the Non-volatile Data Registers is followed by a high voltage cycle after \overline{CS} goes high.

PACKAGE OUTLINE DRAWINGS

SOIC 24-Lead 300mils (W) ⁽¹⁾⁽²⁾

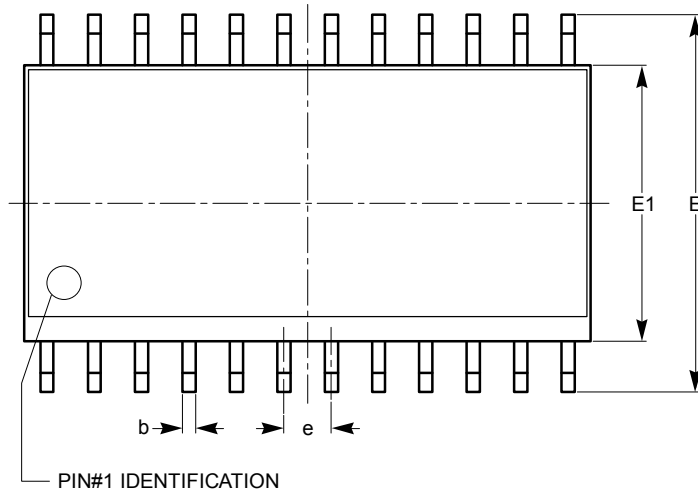

TOP VIEW

| SYMBOL | MIN | NOM | MAX |
|------------|----------|-----|-------|
| A | 2.35 | | 2.65 |
| A1 | 0.10 | | 0.30 |
| A2 | 2.05 | | 2.55 |
| b | 0.31 | | 0.51 |
| c | 0.20 | | 0.33 |
| D | 15.20 | | 15.40 |
| E | 10.11 | | 10.51 |
| E1 | 7.34 | | 7.60 |
| e | 1.27 BSC | | |
| h | 0.25 | | 0.75 |
| L | 0.40 | | 1.27 |
| θ | 0° | | 8° |
| $\theta 1$ | 5° | | 15° |

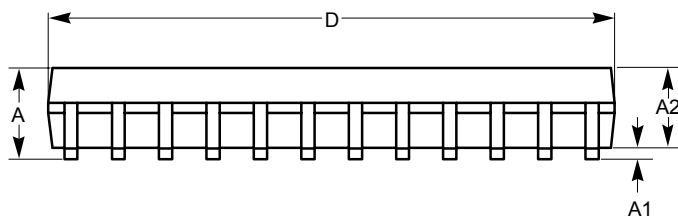

SIDE VIEW

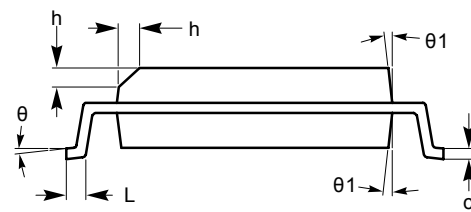

END VIEW

For current Tape and Reel information, download the PDF file from:
<http://www.catsemi.com/documents/tapeandreeel.pdf>.

Notes:

- (1) All dimensions are in millimeters, angles in degrees.
- (2) Complies with JEDEC standard MO-013.

TSSOP 24-Lead 4.4mm (Y) ⁽¹⁾⁽²⁾

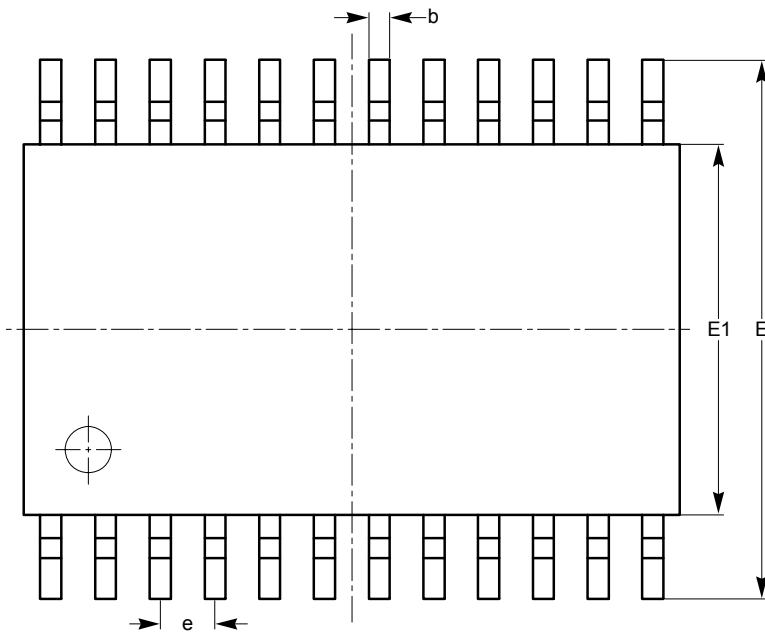

| SYMBOL | MIN | NOM | MAX |
|------------|----------|------|------|
| A | | | 1.20 |
| A1 | 0.05 | | 0.15 |
| A2 | 0.80 | | 1.05 |
| b | 0.19 | | 0.30 |
| c | 0.09 | | 0.20 |
| D | 7.70 | 7.80 | 7.90 |
| E | 6.25 | 6.40 | 6.55 |
| E1 | 4.30 | 4.40 | 4.50 |
| e | 0.65 BSC | | |
| L | 1.00 REF | | |
| L1 | 0.50 | 0.60 | 0.70 |
| $\theta 1$ | 0° | | 8° |

TOP VIEW

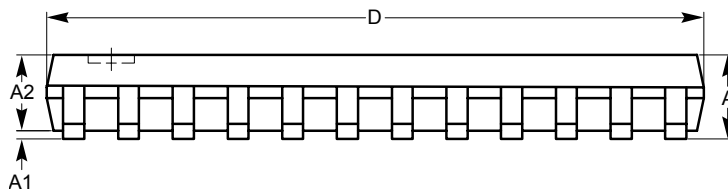

SIDE VIEW

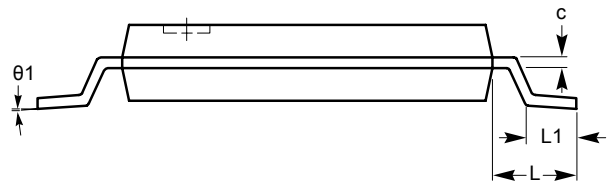

END VIEW

For current Tape and Reel information, download the PDF file from:
<http://www.catsemi.com/documents/tapeandreel.pdf>.

Notes:

- (1) All dimensions are in millimeters, angles in degrees.
- (2) Complies with JEDEC standard MO-153.

EXAMPLE OF ORDERING INFORMATION

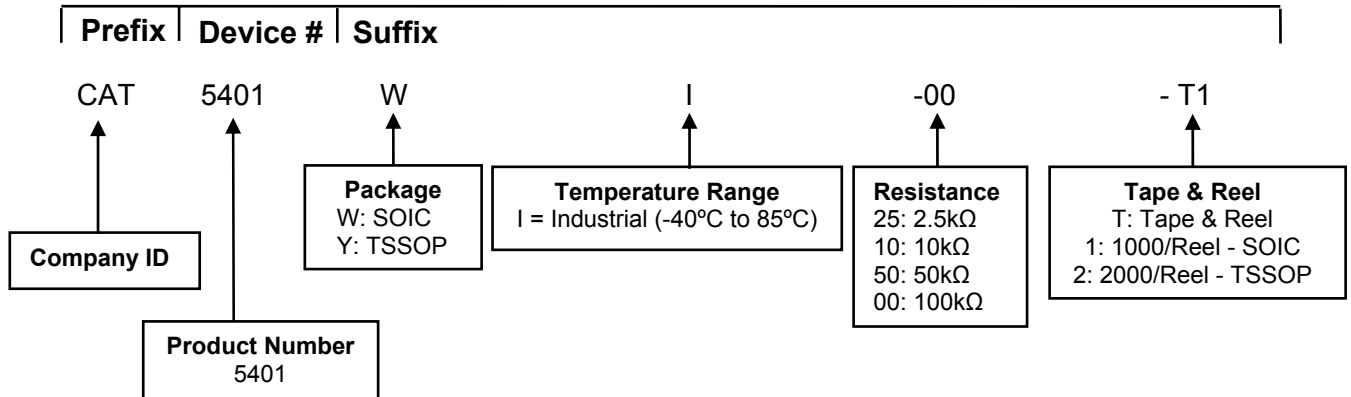

Notes:

- (1) All packages are RoHS-compliant (Lead-free, Halogen-free).
- (2) The device used in the above example is a CAT5401WI-00-T1 (SOIC, Industrial Temperature, 100kΩ, Tape & Reel).
- (3) The lead finish is Matte-Tin.

| Ordering Part Number |
|----------------------|
| CAT5401WI-25 |
| CAT5401WI-10 |
| CAT5401WI-50 |
| CAT5401WI-00 |
| CAT5401YI-25 |
| CAT5401YI-10 |
| CAT5401YI-50 |
| CAT5401YI-00 |

REVISION HISTORY

| Date | Revision | Description |
|-----------|----------|---|
| 31-Mar-04 | F | Changed Preliminary designation to Final Eliminated Commercial temp range in all areas Updated Potentiometer characteristics notes Updated Pin Descriptions (A0, A1 and \overline{WP}) Updated notes for Absolute Max Ratings 80 and Potentiometer Characteristics |
| 16-Oct-07 | G | Added Example of Ordering Information Deleted BGA package Added MD- to document number |
| 25-Aug-08 | H | Update Functional Diagram Update Potentiometer Characteristics notes Update D.C. Operating Characteristics table Update Pin Capacitance table |
| 26-Nov-08 | I | Change logo and fine print to ON Semiconductor |

ON Semiconductor and  are registered trademarks of Semiconductor Components Industries, LLC (SCILLC). SCILLC reserves the right to make changes without further notice to any products herein. SCILLC makes no warranty, representation or guarantee regarding the suitability of its products for any particular purpose, nor does SCILLC assume any liability arising out of the application or use of any product or circuit, and specifically disclaims any and all liability, including without limitation special, consequential or incidental damages. "Typical" parameters which may be provided in SCILLC data sheets and/or specifications can and do vary in different applications and actual performance may vary over time. All operating parameters, including "Typicals" must be validated for each customer application by customer's technical experts. SCILLC does not convey any license under its patent rights nor the rights of others. SCILLC products are not designed, intended, or authorized for use as components in systems intended for surgical implant into the body, or other applications intended to support or sustain life, or for any other application in which the failure of the SCILLC product could create a situation where personal injury or death may occur. Should Buyer purchase or use SCILLC products for any such unintended or unauthorized application, Buyer shall indemnify and hold SCILLC and its officers, employees, subsidiaries, affiliates, and distributors harmless against all claims, costs, damages, and expenses, and reasonable attorney fees arising out of, directly or indirectly, any claim of personal injury or death associated with such unintended or unauthorized use, even if such claim alleges that SCILLC was negligent regarding the design or manufacture of the part. SCILLC is an Equal Opportunity/Affirmative Action Employer. This literature is subject to all applicable copyright laws and is not for resale in any manner.

PUBLICATION ORDERING INFORMATION

LITERATURE FULFILLMENT:

Literature Distribution Center for ON Semiconductor
P.O. Box 5163, Denver, Colorado 80217 USA
Phone: 303-675-2175 or 800-344-3860 Toll Free USA/Canada
Fax: 303-675-2176 or 800-344-3867 Toll Free USA/Canada
Email: orderlit@onsemi.com

N. American Technical Support: 800-282-9855 Toll Free
USA/Canada

Europe, Middle East and Africa Technical Support:
Phone: 421 33 790 2910

Japan Customer Focus Center:
Phone: 81-3-5773-3850

ON Semiconductor Website: www.onsemi.com

Order Literature: <http://www.onsemi.com/orderlit>

For additional information, please contact your local
Sales Representative