

ISL22326

Dual Digitally Controlled Potentiometers (XDCP™) Low Noise, Low Power, I²C™ Bus, 128 Taps

FN6176
Rev 3.00
September 9, 2015

The ISL22326 integrates two digitally controlled potentiometers (XDCP) and non-volatile memory on a monolithic CMOS integrated circuit.

The digitally controlled potentiometers are implemented with a combination of resistor elements and CMOS switches. The position of the wipers are controlled by the user through the I²C bus interface. Each potentiometer has an associated volatile Wiper Register (WR) and a non-volatile Initial Value Register (IVR) that can be directly written to and read by the user. The contents of the WR controls the position of the wiper. At power-up the device recalls the contents of the two DCP's IVR to the corresponding WRs.

The DCPs can be used as three-terminal potentiometers or as two-terminal variable resistors in a wide variety of applications including control, parameter adjustments, and signal processing.

Features

- Two potentiometers in one package
- 128 resistor taps
- I²C serial interface
 - Three address pins, up to eight devices/bus
- Non-volatile storage of wiper position
- Wiper resistance: 70Ω typical @ V_{CC} = 3.3V
- Shutdown mode
- Shutdown current 5μA max
- Power supply: 2.7V to 5.5V
- 50kΩ or 10kΩ total resistance
- High reliability
 - Endurance: 1,000,000 data changes per bit per register
 - Register data retention: 50 years @ T ≤ +55°C
- 14 Ld TSSOP or 16 Ld QFN package
- Pb-free (RoHS compliant)

Pinouts

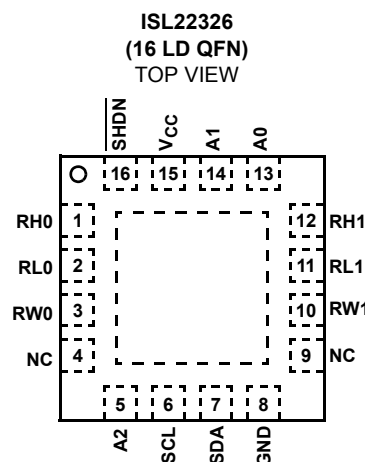
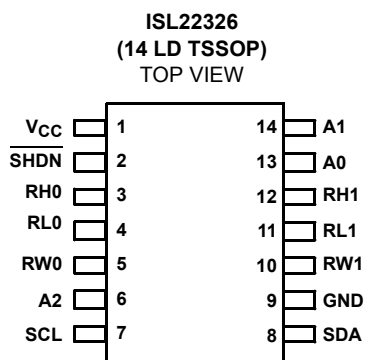

Ordering Information

| PART NUMBER (Note) | PART MARKING | RESISTANCE OPTION (kΩ) | TEMP. RANGE (°C) | PACKAGE (RoHS Compliant) | PKG. DWG. # |
|---|--------------|------------------------------|---------------------|-----------------------------|-------------|
| ISL22326UFV14Z* (No longer available, recommended replacement: ISL22326WFR16Z-TK) | 22326 UFVZ | 50 | -40 to +125 | 14 Ld TSSOP | M14.173 |
| ISL22326UFR16Z* (No longer available, recommended replacement: ISL22326WFR16Z-TK) | 223 26UFZ | 50 | -40 to +125 | 16 Ld 4x4 QFN | L16.4x4A |
| ISL22326WV14Z* | 22326 WFVZ | 10 | -40 to +125 | 14 Ld TSSOP | M14.173 |
| ISL22326WFR16Z* | 223 26WFZ | 10 | -40 to +125 | 16 Ld 4x4 QFN | L16.4x4A |

*Add "-TK" suffix for tape and reel. Please refer to TB347 for details on reel specifications.

NOTE: These Intersil Pb-free plastic packaged products employ special Pb-free material sets, molding compounds/die attach materials, and 100% matte tin plate plus anneal (e3 termination finish, which is RoHS compliant and compatible with both SnPb and Pb-free soldering operations). Intersil Pb-free products are MSL classified at Pb-free peak reflow temperatures that meet or exceed the Pb-free requirements of IPC/JEDEC J STD-020.

Block Diagram

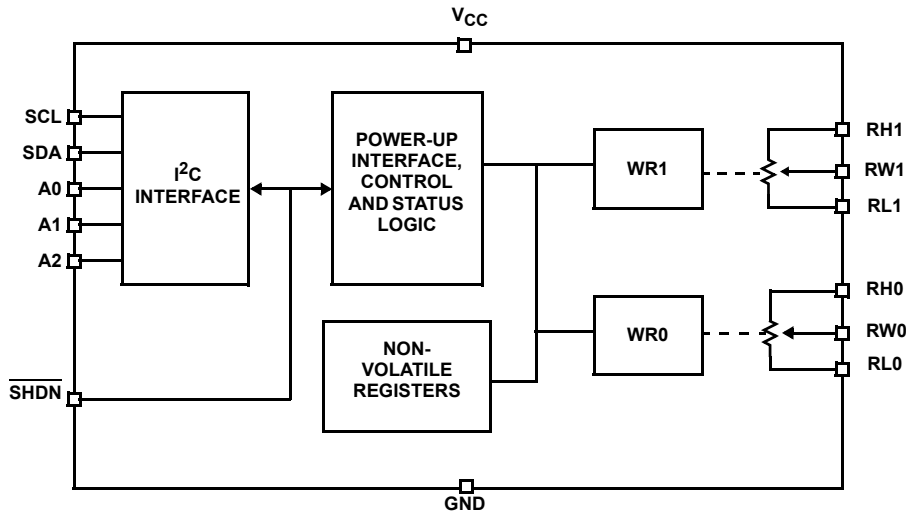

Pin Descriptions

| TSSOP PIN NUMBER | QFN PIN NUMBER | PIN NAME | DESCRIPTION |
|------------------|----------------|--------------------------|---|
| 1 | 15 | V _{CC} | Power supply pin |
| 2 | 16 | $\overline{\text{SHDN}}$ | Shutdown active low input |
| 3 | 1 | RH0 | “High” terminal of DCP0 |
| 4 | 2 | RL0 | “Low” terminal of DCP0 |
| 5 | 3 | RW0 | “Wiper” terminal of DCP0 |
| 6 | 5 | A2 | Device address input for the I ² C interface |
| 7 | 6 | SCL | Open drain I ² C interface clock input |
| 8 | 7 | SDA | Open drain Serial data I/O for the I ² C interface |
| 9 | 8 | GND | Device ground pin |
| 10 | 10 | RW1 | “Wiper” terminal of DCP1 |
| 11 | 11 | RL1 | “Low” terminal of DCP1 |
| 12 | 12 | RH1 | “High” terminal of DCP1 |
| 13 | 13 | A0 | Device address input for the I ² C interface |
| 14 | 14 | A1 | Device address input for the I ² C interface |
| | 4, 9 | NC | No connection |
| | EPAD* | | Exposed Die Pad internally connected to GND |

*Note: PCB thermal land for QFN EPAD should be connected to GND plane or left floating. For more information refer to <http://www.intersil.com/data/tb/TB389.pdf>

Absolute Maximum Ratings

| | |
|---|----------------------------|
| Storage Temperature | -65°C to +150°C |
| Voltage at any Digital Interface Pin with Respect to GND | -0.3V to $V_{CC} + 0.3$ |
| V_{CC} | -0.3V to +6V |
| Voltage at any DCP Pin with Respect to GND | -0.3V to V_{CC} |
| I_W (10s) | ±6mA |
| Latchup (Note 3) | Class II, Level B @ +125°C |
| ESD Ratings | |
| Human Body Model | 2.5kV |
| Machine Model | 350V |

Thermal Information

| | | |
|--|---|----------------------|
| Thermal Resistance (Typical, Notes 1, 2) | θ_{JA} (°C/W) | θ_{JC} (°C/W) |
| 14 Lead TSSOP | 100 | N/A |
| 16 Lead QFN | 40 | 3.0 |
| Maximum Junction Temperature (Plastic Package) | +150°C | |
| Pb-free Reflow Profile | see link below http://www.intersil.com/pbfree/Pb-FreeReflow.asp | |

Recommended Operating Conditions

| | |
|---|-----------------|
| Temperature Range (Extended Industrial) | -40°C to +125°C |
| V_{CC} | 2.7V to 5.5V |
| Power Rating | 15mW |
| Wiper Current | ±3.0mA |

CAUTION: Do not operate at or near the maximum ratings listed for extended periods of time. Exposure to such conditions may adversely impact product reliability and result in failures not covered by warranty.

NOTES:

- θ_{JA} is measured with the component mounted on a high effective thermal conductivity test board in free air. See Tech Brief TB379 for details.
- For θ_{JC} , the "case temp" location is the center of the exposed metal pad on the package underside.
- Jedec Class II pulse conditions and failure criterion used. Level B exceptions are: using a max positive pulse of 6.5V on the SHDN pin, and using a max negative pulse of -0.8V for all pins.

Analog Specifications Over recommended operating conditions, unless otherwise stated.

| SYMBOL | PARAMETER | TEST CONDITIONS | MIN (Note 20) | TYP (Note 4) | MAX (Note 20) | UNIT |
|---|---|---|------------------|-----------------|------------------|---------------------|
| R_{TOTAL} | R_H to R_L Resistance | W option | | 10 | | k Ω |
| | | U option | | 50 | | k Ω |
| | R_H to R_L Resistance Tolerance | W and U option | -20 | | +20 | % |
| | End-to-End Temperature Coefficient | W option | | | ±50 | |
| U option | | | | ±80 | | ppm/°C (Note 17) |
| R_W | Wiper Resistance | $V_{CC} = 3.3V$, wiper current = V_{CC}/R_{TOTAL} | | 70 | 200 | Ω |
| V_{RH} , V_{RL} | V_{RH} and V_{RL} Terminal Voltages | V_{RH} and V_{RL} to GND | 0 | | V_{CC} | V |
| $C_H/C_L/C_W$ (Note 19) | Potentiometer Capacitance | | | 10/10/25 | | pF |
| I_{LkgDCP} | Leakage on DCP Pins | Voltage at pin from GND to V_{CC} | | 0.1 | 1 | μA |
| VOLTAGE DIVIDER MODE (0V @ R_{Li} ; V_{CC} @ R_{Hi} ; measured at R_{Wi} , unloaded; $i = 0$ or 1) | | | | | | |
| INL (Note 9) | Integral Non-linearity | Monotonic over all tap positions, W and U option | -1 | | 1 | LSB (Note 5) |
| DNL (Note 8) | Differential Non-linearity | Monotonic over all tap positions, W and U option | -0.5 | | 0.5 | LSB (Note 5) |
| ZSerror (Note 6) | Zero-scale Error | W option | 0 | 1 | 5 | LSB (Note 5) |
| | | U option | 0 | 0.5 | 2 | |
| FSerror (Note 7) | Full-scale Error | W option | -5 | -1 | 0 | LSB (Note 5) |
| | | U option | -2 | -1 | 0 | |
| V_{MATCH} (Note 10) | DCP to DCP Matching | Any two DCPs at same tap position, same voltage at all RH terminals, and same voltage at all RL terminals | -2 | | 2 | LSB (Note 5) |
| TC_V (Note 11) | Ratiometric Temperature Coefficient | DCP register set to 40 hex | | ±4 | | ppm/°C |

Analog Specifications Over recommended operating conditions, unless otherwise stated. (Continued)

| SYMBOL | PARAMETER | TEST CONDITIONS | MIN (Note 20) | TYP (Note 4) | MAX (Note 20) | UNIT |
|--|----------------------------|---|------------------|-----------------|------------------|-----------------|
| RESISTOR MODE (Measurements between R_{W_i} and R_{L_i} with R_{H_i} not connected, or between R_{W_i} and R_{H_i} with R_{L_i} not connected. $i = 0$ or 1) | | | | | | |
| RINL (Note 15) | Integral Non-linearity | DCP register set between 10h and 7Fh; monotonic over all tap positions | -1 | | 1 | MI (Note 12) |
| RDNL (Note 14) | Differential Non-linearity | DCP register set between 10h and 7Fh; monotonic over all tap positions, W option | -1 | | 1 | MI (Note 12) |
| | | DCP register set between 10h and 7Fh; monotonic over all tap positions, U option | -0.5 | | 0.5 | MI (Note 12) |
| Roffset (Note 13) | Offset | W option | 0 | 1 | 5 | MI (Note 12) |
| | | U option | 0 | 0.5 | 2 | MI (Note 12) |
| R_{MATCH} (Note 16) | DCP to DCP Matching | Any two DCPs at the same tap position with the same terminal voltages | -2 | | 2 | MI (Note 12) |

Operating Specifications Over the recommended operating conditions, unless otherwise specified.

| SYMBOL | PARAMETER | TEST CONDITIONS | MIN (Note 20) | TYP (Note 4) | MAX (Note 20) | UNIT |
|----------------------------|--|---|------------------|-----------------|------------------|------|
| I_{CC1} | V_{CC} Supply Current (Volatile Write/Read) | $f_{SCL} = 400\text{kHz}$; SDA = Open; (for I ² C, active, read and write states) | | | 0.5 | mA |
| I_{CC2} | V_{CC} Supply Current (Non-volatile Write/Read) | $f_{SCL} = 400\text{kHz}$; SDA = Open; (for I ² C, active, read and write states) | | | 3 | mA |
| I_{SB} | V_{CC} Current (Standby) | $V_{CC} = +5.5\text{V}$ @ +85°C, I ² C interface in standby state | | | 5 | μA |
| | | $V_{CC} = +5.5\text{V}$ @ +125°C, I ² C interface in standby state | | | 7 | μA |
| | | $V_{CC} = +3.6\text{V}$ @ +85°C, I ² C interface in standby state | | | 3 | μA |
| | | $V_{CC} = +3.6\text{V}$ @ +125°C, I ² C interface in standby state | | | 5 | μA |
| I_{SD} | V_{CC} Current (Shutdown) | $V_{CC} = +5.5\text{V}$ @ +85°C, I ² C interface in standby state | | | 3 | μA |
| | | $V_{CC} = +5.5\text{V}$ @ +125°C, I ² C interface in standby state | | | 5 | μA |
| | | $V_{CC} = +3.6\text{V}$ @ +85°C, I ² C interface in standby state | | | 2 | μA |
| | | $V_{CC} = +3.6\text{V}$ @ +125°C, I ² C interface in standby state | | | 4 | μA |
| I_{LkgDig} | Leakage Current, at Pins A0, A1, A2, SHDN, SDA and SCL | Voltage at pin from GND to V_{CC} | -1 | | 1 | μA |
| t_{WRT} (Note 19) | DCP Wiper Response Time | SCL falling edge of last bit of DCP data byte to wiper new position | | 1.5 | | μs |
| $t_{ShdnRec}$ (Note 19) | DCP Recall Time from Shutdown Mode | From rising edge of SHDN signal to wiper stored position and RH connection | | 1.5 | | μs |
| | | SCL falling edge of last bit of ACR data byte to wiper stored position and RH connection | | 1.5 | | μs |
| Vpor | Power-on Recall Voltage | Minimum V_{CC} at which memory recall occurs | 2.0 | | 2.6 | V |
| VccRamp | V_{CC} Ramp Rate | | 0.2 | | | V/ms |

Operating Specifications Over the recommended operating conditions, unless otherwise specified. (Continued)

| SYMBOL | PARAMETER | TEST CONDITIONS | MIN (Note 20) | TYP (Note 4) | MAX (Note 20) | UNIT |
|--|---|--|----------------------|-----------------|--------------------|--------|
| t_D | Power-up Delay | V_{CC} above V_{por} , to DCP Initial Value Register recall completed, and I ² C Interface in standby state | | | 3 | ms |
| EEPROM SPECIFICATION | | | | | | |
| | EEPROM Endurance | | 1,000,000 | | | Cycles |
| | EEPROM Retention | Temperature $T \leq +55^\circ\text{C}$ | 50 | | | Years |
| t_{WC} (Note 18) | Non-volatile Write Cycle Time | | | 12 | 20 | ms |
| SERIAL INTERFACE SPECIFICATIONS | | | | | | |
| V_{IL} | A2, A1, A0, $\overline{\text{SHDN}}$, SDA, and SCL Input Buffer LOW Voltage | | -0.3 | | $0.3 \cdot V_{CC}$ | V |
| V_{IH} | A2, A1, A0, $\overline{\text{SHDN}}$, SDA, and SCL Input Buffer HIGH Voltage | | $0.7 \cdot V_{CC}$ | | $V_{CC} + 0.3$ | V |
| Hysteresis | SDA and SCL Input Buffer Hysteresis | | $0.05 \cdot V_{CC}$ | | | V |
| V_{OL} | SDA Output Buffer LOW Voltage, Sinking 4mA | | 0 | | 0.4 | V |
| C_{pin} (Note 19) | A2, A1, A0, $\overline{\text{SHDN}}$, SDA, and SCL Pin Capacitance | | | 10 | | pF |
| f_{SCL} | SCL Frequency | | | | 400 | kHz |
| t_{sp} | Pulse Width Suppression Time at SDA and SCL Inputs | Any pulse narrower than the max spec is suppressed | | | 50 | ns |
| t_{AA} | SCL falling edge to SDA output data valid | SCL falling edge crossing 30% of V_{CC} , until SDA exits the 30% to 70% of V_{CC} window | | | 900 | ns |
| t_{BUF} | Time the Bus Must be Free Before the Start of a New Transmission | SDA crossing 70% of V_{CC} during a STOP condition, to SDA crossing 70% of V_{CC} during the following START condition | 1300 | | | ns |
| t_{LOW} | Clock LOW Time | Measured at the 30% of V_{CC} crossing | 1300 | | | ns |
| t_{HIGH} | Clock HIGH Time | Measured at the 70% of V_{CC} crossing | 600 | | | ns |
| $t_{SU:STA}$ | START Condition Setup Time | SCL rising edge to SDA falling edge; both crossing 70% of V_{CC} | 600 | | | ns |
| $t_{HD:STA}$ | START Condition Hold Time | From SDA falling edge crossing 30% of V_{CC} to SCL falling edge crossing 70% of V_{CC} | 600 | | | ns |
| $t_{SU:DAT}$ | Input Data Setup Time | From SDA exiting the 30% to 70% of V_{CC} window, to SCL rising edge crossing 30% of V_{CC} | 100 | | | ns |
| $t_{HD:DAT}$ | Input Data Hold Time | From SCL rising edge crossing 70% of V_{CC} to SDA entering the 30% to 70% of V_{CC} window | 0 | | | ns |
| $t_{SU:STO}$ | STOP Condition Setup Time | From SCL rising edge crossing 70% of V_{CC} to SDA rising edge crossing 30% of V_{CC} | 600 | | | ns |
| $t_{HD:STO}$ | STOP Condition Hold Time for Read, or Volatile Only Write | From SDA rising edge to SCL falling edge; both crossing 70% of V_{CC} | 1300 | | | ns |
| t_{DH} | Output Data Hold Time | From SCL falling edge crossing 30% of V_{CC} , until SDA enters the 30% to 70% of V_{CC} window | 0 | | | ns |
| t_R | SDA and SCL Rise Time | From 30% to 70% of V_{CC} | $20 + 0.1 \cdot C_b$ | | 250 | ns |
| t_F | SDA and SCL Fall Time | From 70% to 30% of V_{CC} | $20 + 0.1 \cdot C_b$ | | 250 | ns |

Operating Specifications Over the recommended operating conditions, unless otherwise specified. (Continued)

| SYMBOL | PARAMETER | TEST CONDITIONS | MIN (Note 20) | TYP (Note 4) | MAX (Note 20) | UNIT |
|------------|---|---|------------------|-----------------|------------------|------------|
| Cb | Capacitive Loading of SDA or SCL | Total on-chip and off-chip | 10 | | 400 | pF |
| Rpu | SDA and SCL Bus Pull-up Resistor Off-chip | Maximum is determined by t_R and t_F For Cb = 400pF, max is about 2k Ω ~2.5k Ω For Cb = 40pF, max is about 15k Ω ~20k Ω | 1 | | | k Ω |
| $t_{SU:A}$ | A2, A1 and A0 Setup Time | Before START condition | 600 | | | ns |
| $t_{HD:A}$ | A2, A1 and A0 Hold Time | After STOP condition | 600 | | | ns |

NOTES:

4. Typical values are for $T_A = +25^\circ\text{C}$ and 3.3V supply voltage
5. LSB: $[V(RW)_{127} - V(RW)_0]/127$. $V(RW)_{127}$ and $V(RW)_0$ are $V(RW)$ for the DCP register set to 7F hex and 00 hex respectively. LSB is the incremental voltage when changing from one tap to an adjacent tap.
6. ZS error = $V(RW)_0/\text{LSB}$.
7. FS error = $[V(RW)_{127} - V_{CC}]/\text{LSB}$.
8. DNL = $[V(RW)_i - V(RW)_{i-1}]/\text{LSB} - 1$, for $i = 1$ to 127. i is the DCP register setting.
9. INL = $[V(RW)_i - i \cdot \text{LSB} - V(RW)_0]/\text{LSB}$ for $i = 1$ to 127.
10. $V_{\text{MATCH}} = [V(RW_x)_i - V(RW_y)_j]/\text{LSB}$, for $i = 1$ to 127, $x = 0$ to 1 and $y = 0$ to 1.
11. $TC_V = \frac{\text{Max}(V(RW)_i) - \text{Min}(V(RW)_i)}{[\text{Max}(V(RW)_i) + \text{Min}(V(RW)_i)]/2} \times \frac{10^6}{+165^\circ\text{C}}$ for $i = 16$ to 112 decimal, $T = -40^\circ\text{C}$ to $+125^\circ\text{C}$. $\text{Max}()$ is the maximum value of the wiper voltage and $\text{Min}()$ is the minimum value of the wiper voltage over the temperature range.
12. $MI = |RW_{127} - RW_0|/127$. MI is a minimum increment. RW_{127} and RW_0 are the measured resistances for the DCP register set to 7F hex and 00 hex respectively.
13. $R_{\text{offset}} = RW_0/MI$, when measuring between RW and RL .
 $R_{\text{offset}} = RW_{127}/MI$, when measuring between RW and RH .
14. $RDNL = (RW_i - RW_{i-1})/MI - 1$, for $i = 16$ to 127.
15. $RINL = [RW_i - (MI \cdot i) - RW_0]/MI$, for $i = 16$ to 127.
16. $R_{\text{MATCH}} = (RW_{i,x} - RW_{i,y})/MI$, for $i = 1$ to 127, $x = 0$ to 1 and $y = 0$ to 1.
17. $TC_R = \frac{[\text{Max}(Ri) - \text{Min}(Ri)]}{[\text{Max}(Ri) + \text{Min}(Ri)]/2} \times \frac{10^6}{+165^\circ\text{C}}$ for $i = 16$ to 112, $T = -40^\circ\text{C}$ to $+125^\circ\text{C}$. $\text{Max}()$ is the maximum value of the resistance and $\text{Min}()$ is the minimum value of the resistance over the temperature range.
18. t_{WC} is the time from a valid STOP condition at the end of a Write sequence of I²C serial interface, to the end of the self-timed internal non-volatile write cycle.
19. Limits should be considered typical and are not production tested.
20. Parameters with MIN and/or MAX limits are 100% tested at $+25^\circ\text{C}$, unless otherwise specified. Temperature limits established by characterization and are not production tested.

SDA vs SCL Timing

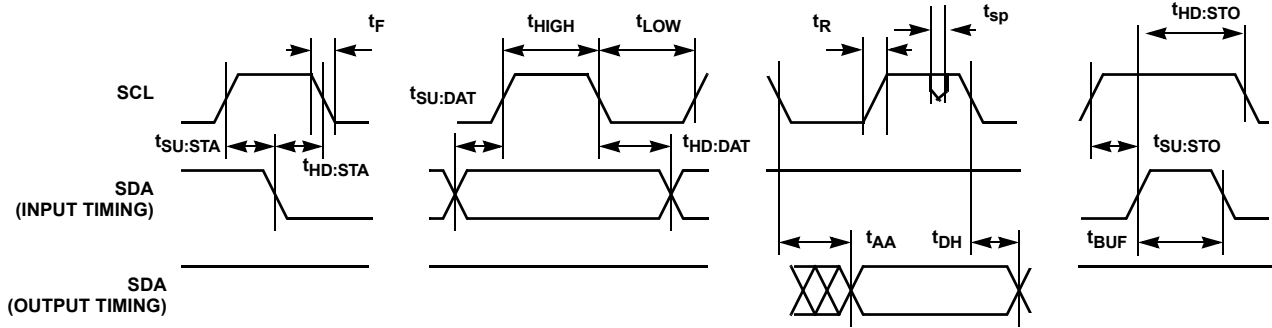

A0, A1, and A2 Pin Timing

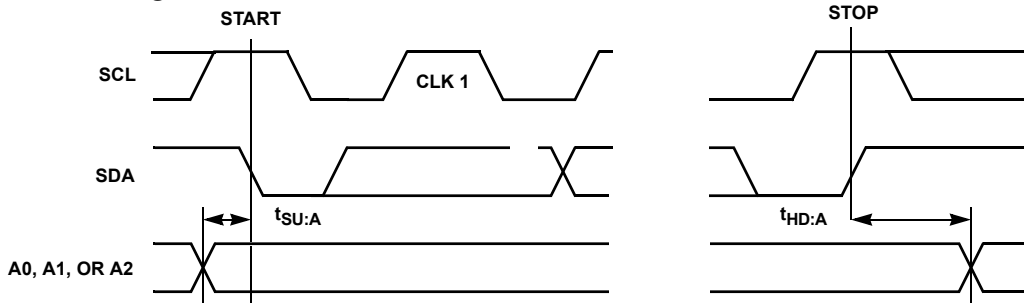

Typical Performance Curves

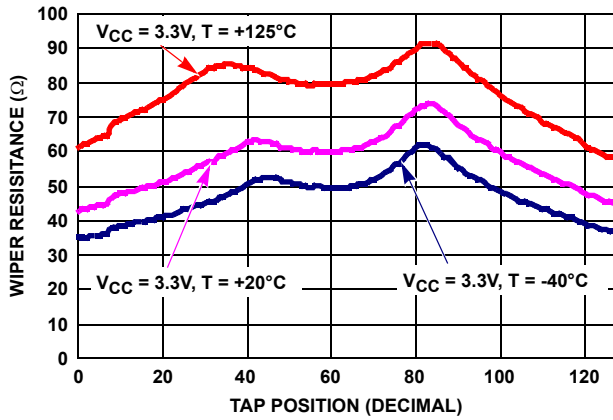

FIGURE 1. WIPER RESISTANCE vs TAP POSITION [$I(RW) = V_{CC}/R_{TOTAL}$] FOR 10k Ω (W)

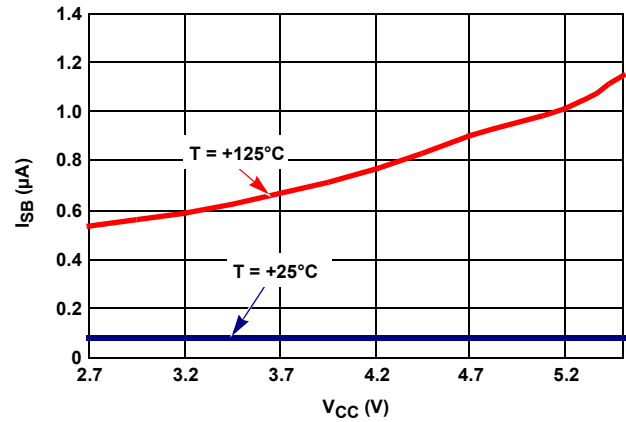

FIGURE 2. STANDBY I_{CC} vs V_{CC}

Typical Performance Curves (Continued)

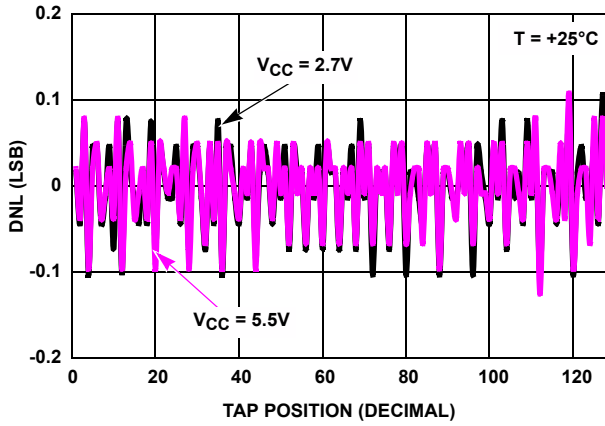

FIGURE 3. DNL vs TAP POSITION IN VOLTAGE DIVIDER MODE FOR 10kΩ (W)

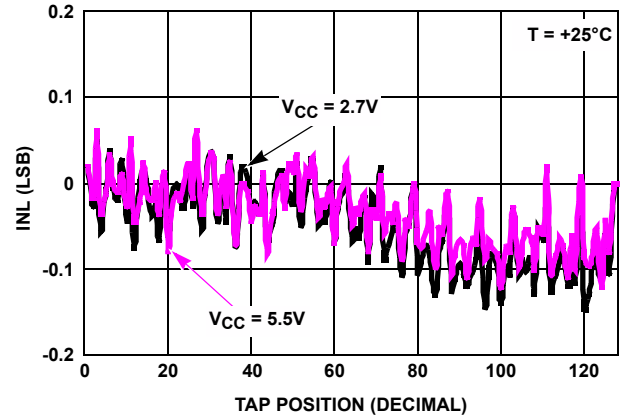

FIGURE 4. INL vs TAP POSITION IN VOLTAGE DIVIDER MODE FOR 10kΩ (W)

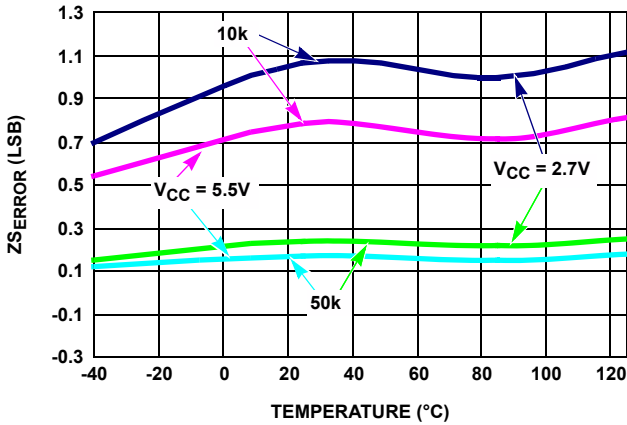

FIGURE 5. ZSERROR vs TEMPERATURE

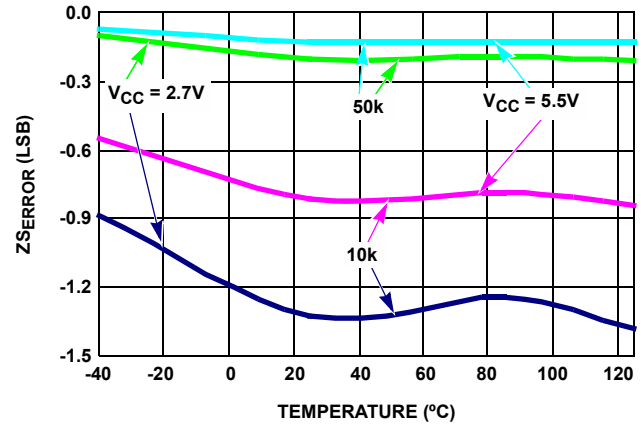

FIGURE 6. FSERROR vs TEMPERATURE

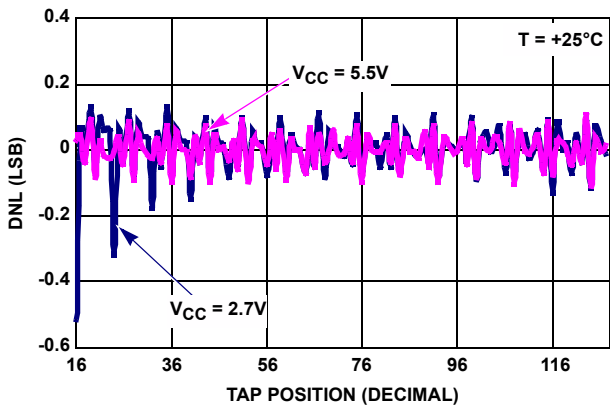

FIGURE 7. DNL vs TAP POSITION IN RHEOSTAT MODE FOR 10kΩ (W)

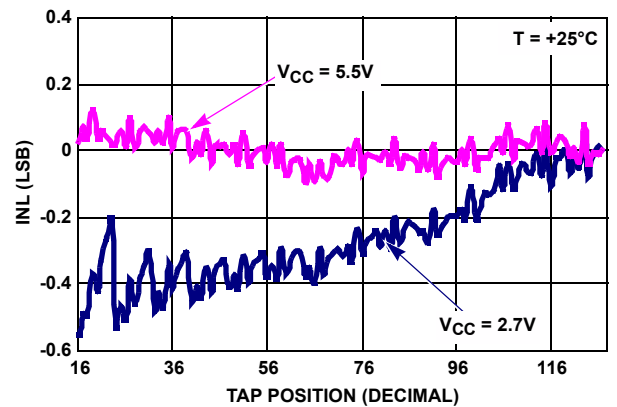

FIGURE 8. INL vs TAP POSITION IN RHEOSTAT MODE FOR 10kΩ (W)

Typical Performance Curves (Continued)

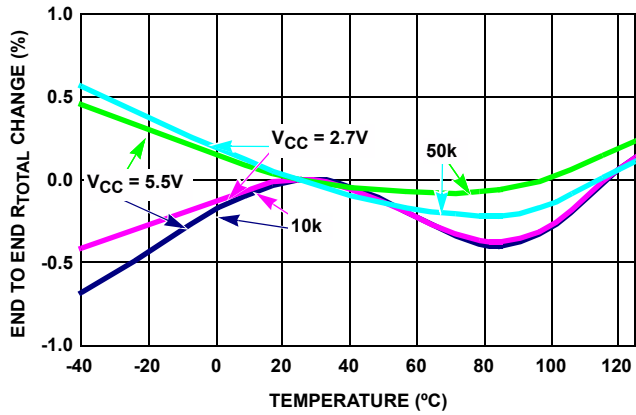

FIGURE 9. END TO END R_{TOTAL} % CHANGE vs TEMPERATURE

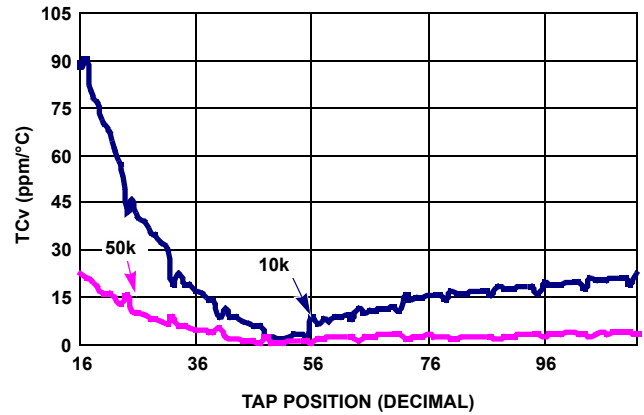

FIGURE 10. TC FOR VOLTAGE DIVIDER MODE IN ppm

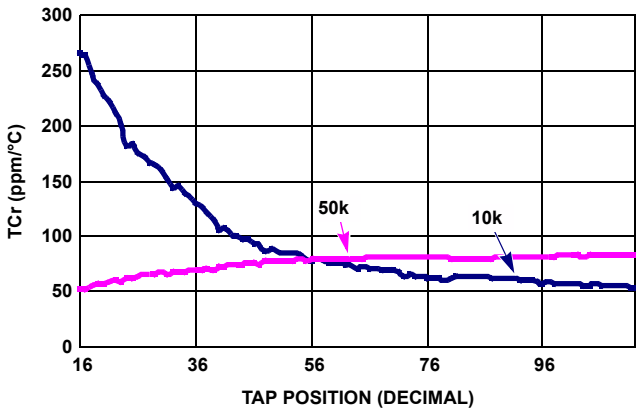

FIGURE 11. TC FOR RHEOSTAT MODE IN ppm

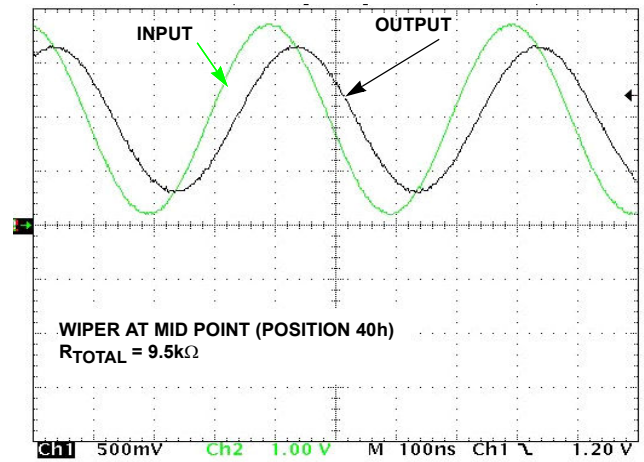

FIGURE 12. FREQUENCY RESPONSE (2.6MHz)

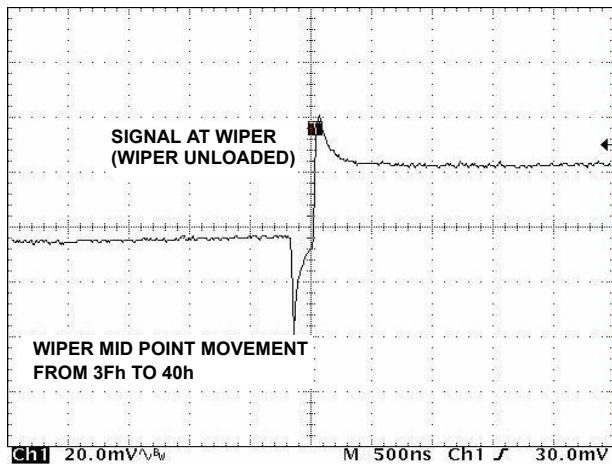

FIGURE 13. MIDSCALE GLITCH, CODE 3Fh TO 40h

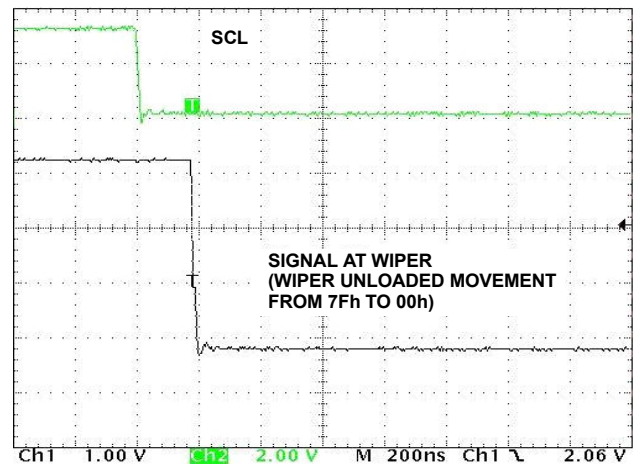

FIGURE 14. LARGE SIGNAL SETTLING TIME

Pin Descriptions

Potentiometers Pins

RHI AND RLI (i = 0, 1)

The high (RHi) and low (RLi) terminals of the ISL22326 are equivalent to the fixed terminals of a mechanical potentiometer. RHi and RLi are referenced to the relative position of the wiper and not the voltage potential on the terminals. With WRi set to 127 decimal, the wiper will be closest to RHi, and with the WRi set to 0, the wiper is closest to RLi.

RWi (i = 0,1)

RWi is the wiper terminal and is equivalent to the movable terminal of a mechanical potentiometer. The position of the wiper within the array is determined by the WRi register.

SHDN

The SHDN pin forces the resistor to end-to-end open circuit condition on RHi and shorts RWi to RLi. When SHDN is returned to logic high, the previous latch settings put RWi at the same resistance setting prior to shutdown. This pin is logically ANDed with SHDN bit in ACR register. I²C interface is still available in shutdown mode and all registers are accessible. This pin must remain HIGH for normal operation.

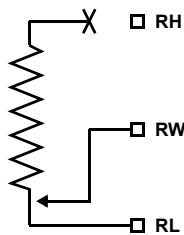

FIGURE 15. DCP CONNECTION IN SHUTDOWN MODE

Bus Interface Pins

SERIAL DATA INPUT/OUTPUT (SDA)

The SDA is a bidirectional serial data input/output pin for I²C interface. It receives device address, operation code, wiper address and data from an I²C external master device at the rising edge of the serial clock SCL, and it shifts out data after each falling edge of the serial clock.

SDA requires an external pull-up resistor, since it is an open drain input/output.

SERIAL CLOCK (SCL)

This is the serial clock input of the I²C serial interface. SCL requires an external pull-up resistor, since it is an open drain input.

DEVICE ADDRESS (A2 - A0)

The address inputs are used to set the least significant 3 bits of the 7-bit I²C interface slave address. A match in the slave address serial data stream must match with the Address input pins in order to initiate communication with the ISL22326. A maximum of 8 ISL22326 devices may occupy the I²C serial bus.

Principles of Operation

The ISL22326 is an integrated circuit incorporating two DCPs with their associated registers, non-volatile memory and an I²C serial interface providing direct communication between a host and the potentiometers and memory. The resistor arrays are comprised of individual resistors connected in series. At either end of the array and between each resistor is an electronic switch that transfers the potential at that point to the wiper.

The electronic switches on the device operate in a “make before break” mode when the wiper changes tap positions.

When the device is powered down, the last value stored in IVRi will be maintained in the non-volatile memory. When power is restored, the contents of the IVRi are recalled and loaded into the corresponding WRi to set the wipers to the initial value.

DCP Description

Each DCP is implemented with a combination of resistor elements and CMOS switches. The physical ends of each DCP are equivalent to the fixed terminals of a mechanical potentiometer (RH and RL pins). The RW pin of each DCP is connected to intermediate nodes, and is equivalent to the wiper terminal of a mechanical potentiometer. The position of the wiper terminal within the DCP is controlled by volatile Wiper Register (WR). Each DCP has its own WR. When the WR of a DCP contains all zeroes (WR[6:0]= 00h), its wiper terminal (RW) is closest to its “Low” terminal (RL). When the WR register of a DCP contains all ones (WR[6:0] = 7Fh), its wiper terminal (RW) is closest to its “High” terminal (RH). As the value of the WR increases from all zeroes (0) to all ones (127 decimal), the wiper moves monotonically from the position closest to RL to the closest to RH. At the same time, the resistance between RW and RL increases monotonically, while the resistance between RH and RW decreases monotonically.

While the ISL22326 is being powered up, all WRs are reset to 40h (64 decimal), which locates RW roughly at the center between RL and RH. After the power supply voltage becomes large enough for reliable non-volatile memory reading, all WRs will be reload with the value stored in corresponding non-volatile Initial Value Registers (IVRs).

The WRs can be read or written to directly using the I²C serial interface as described in the following sections. The I²C interface Address Byte has to be set to 00h or 01h to access the WR of DCP0 or DCP1 respectively.

Memory Description

The ISL22326 contains seven non-volatile and three volatile 8-bit registers. Memory map of ISL22326 is on Table 1. The two non-volatile registers (IVRi) at address 0 and 1, contain initial wiper value and volatile registers (WRi) contain current wiper position. In addition, five non-volatile General Purpose registers from address 2 to address 6 are available.

TABLE 1. MEMORY MAP

| ADDRESS | NON-VOLATILE | VOLATILE |
|---------|-----------------|---------------|
| 8 | — | ACR |
| 7 | Reserved | |
| 6 | General Purpose | Not Available |
| 5 | General Purpose | Not Available |
| 4 | General Purpose | Not Available |
| 3 | General Purpose | Not Available |
| 2 | General Purpose | Not Available |
| 1 | IVR1 | WR1 |
| 0 | IVR0 | WR0 |

The non-volatile IVR_i and volatile WR_i registers are accessible with the same address.

The Access Control Register (ACR) contains information and control bits described in Table 2. The VOL bit at access control register (ACR[7]) determines whether the access is to wiper registers WR_i or initial value registers IVR_i.

TABLE 2. ACCESS CONTROL REGISTER (ACR)

| VOL | SHDN | WIP | 0 | 0 | 0 | 0 | 0 |
|-----|------|-----|---|---|---|---|---|
| 0 | 0 | 0 | 0 | 0 | 0 | 0 | 0 |

If VOL bit is 0, the non-volatile IVR_i registers are accessible. If VOL bit is 1, only the volatile WR_i are accessible. Note, value is written to IVR_i register also is written to the corresponding WR_i. The default value of this bit is 0.

The SHDN bit (ACR[6]) disables or enables Shutdown mode. This bit is logically ANDed with SHDN pin. When this bit is 0, DCP is in Shutdown mode. Default value of SHDN bit is 1.

The WIP bit (ACR[5]) is read only bit. It indicates that non-volatile write operation is in progress. It is impossible to write to the IVR_i, WR_i or ACR while WIP bit is 1.

Shutdown Mode

The device can be put in Shutdown mode either by pulling the SHDN pin to GND or setting the SHDN bit in the ACR register to 0. The truth table for Shutdown mode is in Table 3.

TABLE 3.

| SHDN pin | SHDN bit | Mode |
|----------|----------|------------------|
| High | 1 | Normal operation |
| Low | 1 | Shutdown |
| High | 0 | Shutdown |
| Low | 0 | Shutdown |

I²C Serial Interface

The ISL22326 supports an I²C bidirectional bus oriented protocol. The protocol defines any device that sends data onto the bus as a transmitter and the receiving device as the receiver. The device controlling the transfer is a master and the device being controlled is the slave. The master always initiates data transfers and provides the clock for both transmit

and receive operations. Therefore, the ISL22326 operates as a slave device in all applications.

All communication over the I²C interface is conducted by sending the MSB of each byte of data first.

Protocol Conventions

Data states on the SDA line must change only during SCL LOW periods. SDA state changes during SCL HIGH are reserved for indicating START and STOP conditions (see Figure 16). On power-up of the ISL22326, the SDA pin is in the input mode.

All I²C interface operations must begin with a START condition, which is a HIGH to LOW transition of SDA while SCL is HIGH. The ISL22326 continuously monitors the SDA and SCL lines for the START condition and does not respond to any command until this condition is met (see Figure 16). A START condition is ignored during the power-up of the device.

All I²C interface operations must be terminated by a STOP condition, which is a LOW to HIGH transition of SDA while SCL is HIGH (see Figure 16). A STOP condition at the end of a read operation, or at the end of a write operation places the device in its standby mode.

An ACK, Acknowledge, is a software convention used to indicate a successful data transfer. The transmitting device, either master or slave, releases the SDA bus after transmitting eight bits. During the ninth clock cycle, the receiver pulls the SDA line LOW to acknowledge the reception of the eight bits of data (see Figure 17).

The ISL22326 responds with an ACK after recognition of a START condition followed by a valid Identification Byte, and once again after successful receipt of an Address Byte. The ISL22326 also responds with an ACK after receiving a Data Byte of a write operation. The master must respond with an ACK after receiving a Data Byte of a read operation.

A valid Identification Byte contains 1010 as the four MSBs, and the following three bits matching the logic values present at pins A2, A1, and A0. The LSB is the Read/Write bit. Its value is "1" for a Read operation, and "0" for a Write operation (see Table 4).

TABLE 4. IDENTIFICATION BYTE FORMAT

Logic values at pins A2, A1, and A0 respectively

| | | | | | | | |
|-------|---|---|---|----|----|----|-------|
| 1 | 0 | 1 | 0 | A2 | A1 | A0 | R/W |
| (MSB) | | | | | | | (LSB) |

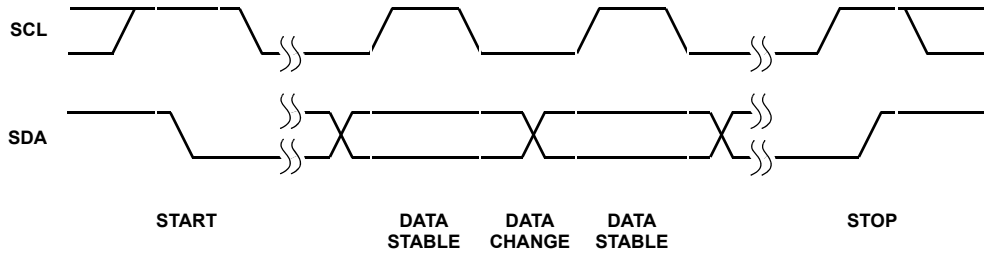

FIGURE 16. VALID DATA CHANGES, START AND STOP CONDITIONS

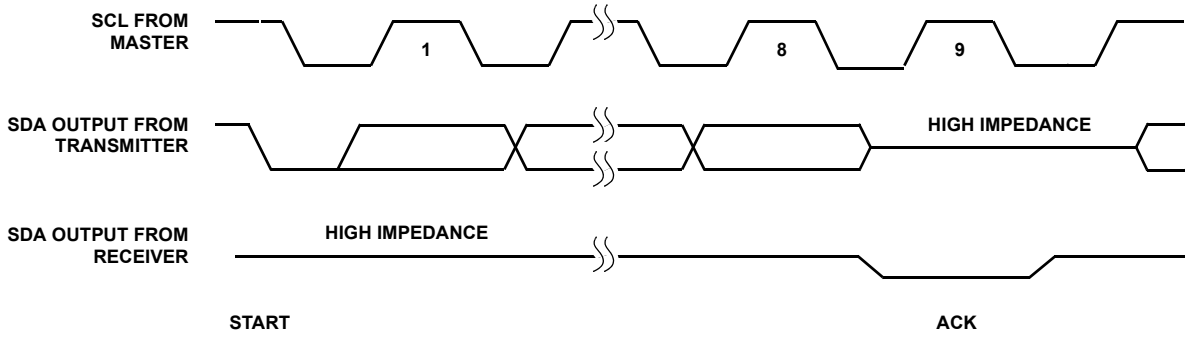

FIGURE 17. ACKNOWLEDGE RESPONSE FROM RECEIVER

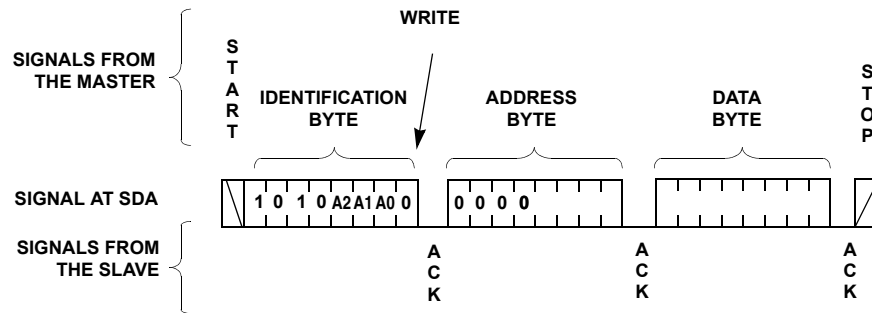

FIGURE 18. BYTE WRITE SEQUENCE

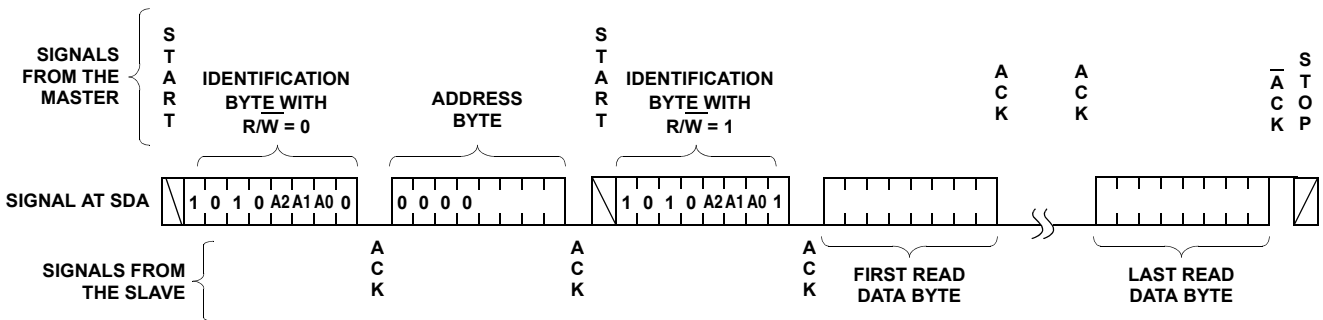

FIGURE 19. READ SEQUENCE

Write Operation

A Write operation requires a START condition, followed by a valid Identification Byte, a valid Address Byte, a Data Byte, and a STOP condition. After each of the three bytes, the ISL22326 responds with an ACK. At this time, the device enters its standby state (see Figure 18). The device can receive more than one byte of data by auto incrementing the address after each received byte. Note after reaching the address 08h, the internal pointer “rolls over” to address 00h.

The non-volatile write cycle starts after STOP condition is determined and it requires up to 20ms delay for the next non-volatile write. Thus, non-volatile registers must be written individually.

Read Operation

A Read operation consist of a three byte instruction followed by one or more Data Bytes (see Figure 19). The master initiates the operation issuing the following sequence: a START, the Identification byte with the R/W bit set to “0”, an Address Byte, a second START, and a second Identification byte with the R/W bit set to “1”. After each of the three bytes, the ISL22326 responds with an ACK. Then the ISL22326 transmits Data Bytes as long as the master responds with an ACK during the SCL cycle following the eighth bit of each byte. The master terminates the read operation (issuing a $\overline{\text{ACK}}$ and a STOP condition) following the last bit of the last Data Byte (see Figure 19).

The Data Bytes are from the registers indicated by an internal pointer. This pointer initial value is determined by the Address Byte in the Read operation instruction, and increments by one during transmission of each Data Byte. After reaching the memory location 08h, the pointer “rolls over” to 00h, and the device continues to output data for each ACK received.

In order to read back the non-volatile IVR, it is recommended that the application reads the ACR first to verify the WIP bit is 0. If the WIP bit (ACR[5]) is not 0, the host should repeat its reading sequence again.

Revision History

The revision history provided is for informational purposes only and is believed to be accurate, but not warranted. Please go to the web to make sure that you have the latest revision.

| DATE | REVISION | CHANGE |
|-------------------|----------|--|
| September 9, 2015 | FN6176.3 | Updated Ordering Information table on page 2. Added Revision History and About Intersil sections. Updated Package Outline Drawing L16.4x4A to the latest revision. -Revision 2 to Revision 3 changes - Updated to new POD format by removing table listing dimensions and moving dimensions onto drawing. Added Typical Recommended Land Pattern. Removed package option. Updated Package Outline Drawing M14.173 to the latest revision. -Revision 2 to Revision 3 changes - Updated drawing to remove table and added land pattern. |

About Intersil

Intersil Corporation is a leading provider of innovative power management and precision analog solutions. The company's products address some of the largest markets within the industrial and infrastructure, mobile computing and high-end consumer markets.

For the most updated datasheet, application notes, related documentation and related parts, please see the respective product information page found at www.intersil.com.

You may report errors or suggestions for improving this datasheet by visiting www.intersil.com/ask.

Reliability reports are also available from our website at www.intersil.com/support.

© Copyright Intersil Americas LLC 2006-2015. All Rights Reserved.
All trademarks and registered trademarks are the property of their respective owners.

For additional products, see www.intersil.com/en/products.html

Intersil products are manufactured, assembled and tested utilizing ISO9001 quality systems as noted in the quality certifications found at www.intersil.com/en/support/qualandreliability.html

Intersil products are sold by description only. Intersil may modify the circuit design and/or specifications of products at any time without notice, provided that such modification does not, in Intersil's sole judgment, affect the form, fit or function of the product. Accordingly, the reader is cautioned to verify that datasheets are current before placing orders. Information furnished by Intersil is believed to be accurate and reliable. However, no responsibility is assumed by Intersil or its subsidiaries for its use; nor for any infringements of patents or other rights of third parties which may result from its use. No license is granted by implication or otherwise under any patent or patent rights of Intersil or its subsidiaries.

For information regarding Intersil Corporation and its products, see www.intersil.com

Package Outline Drawing

L16.4x4A

16 LEAD QUAD FLAT NO-LEAD PLASTIC PACKAGE

Rev 3, 03/15

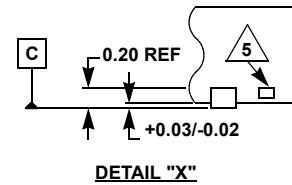
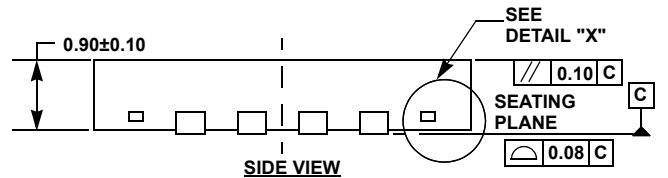
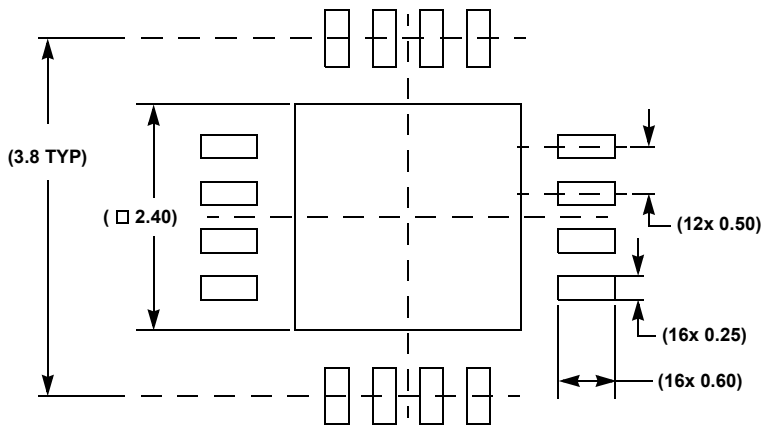
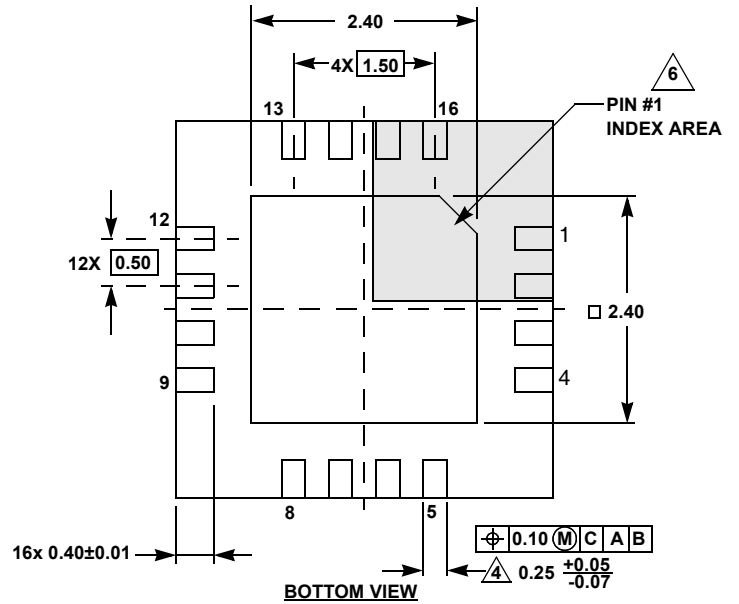
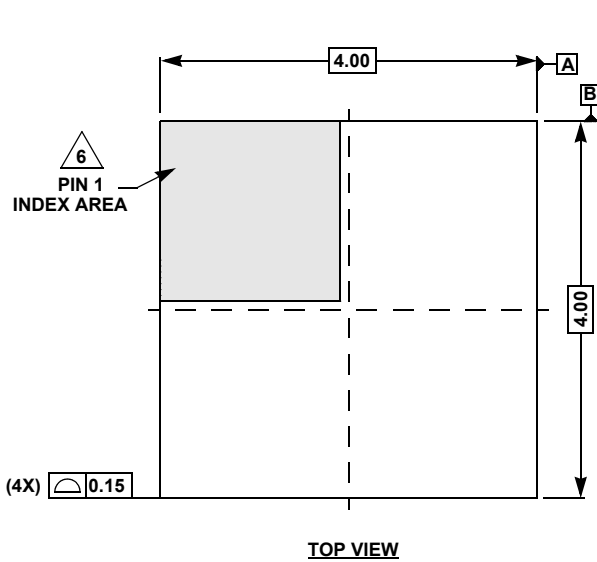

NOTES:

1. Dimensions are in millimeters.
Dimensions in () for Reference Only.
2. Dimensioning and tolerancing conform to ASME Y14.5m-1994.
3. Unless otherwise specified, tolerance: Decimal ± 0.05
4. Dimension applies to the metallized terminal and is measured between 0.15mm and 0.30mm from the terminal tip.
5. Tiebar shown (if present) is a non-functional feature.
6. The configuration of the pin #1 identifier is optional, but must be located within the zone indicated. The pin #1 identifier may be either a mold or mark feature.

Package Outline Drawing

M14.173

14 LEAD THIN SHRINK SMALL OUTLINE PACKAGE (TSSOP)

Rev 3, 10/09

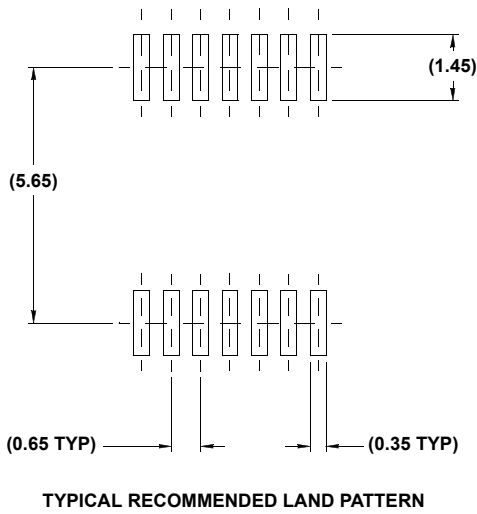
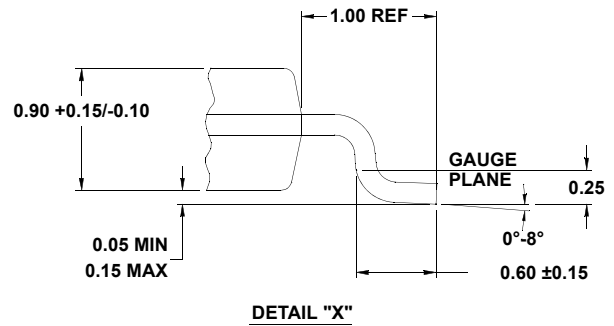
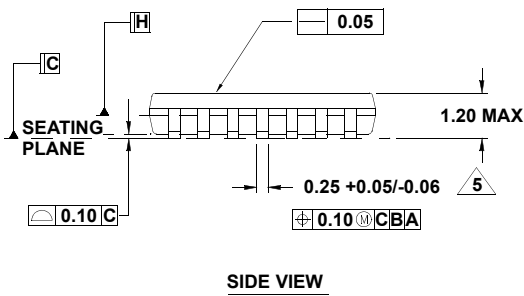
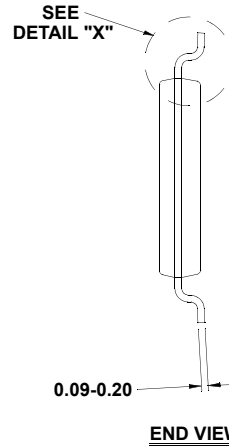
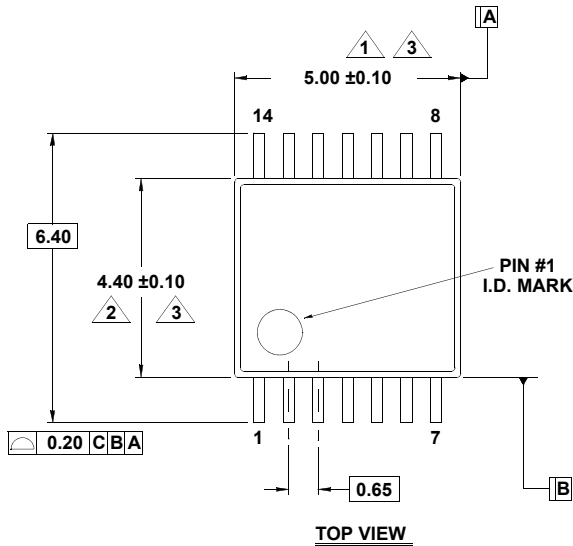

NOTES:

1. Dimension does not include mold flash, protrusions or gate burrs. Mold flash, protrusions or gate burrs shall not exceed 0.15 per side.
2. Dimension does not include interlead flash or protrusion. Interlead flash or protrusion shall not exceed 0.25 per side.
3. Dimensions are measured at datum plane H.
4. Dimensioning and tolerancing per ASME Y14.5M-1994.
5. Dimension does not include dambar protrusion. Allowable protrusion shall be 0.80mm total in excess of dimension at maximum material condition. Minimum space between protrusion and adjacent lead is 0.07mm.
6. Dimension in () are for reference only.
7. Conforms to JEDEC MO-153, variation AB-1.