

NOT RECOMMENDED FOR NEW DESIGNS
RECOMMENDED REPLACEMENT PART
ISL22424

ISL22426

Dual Digitally Controlled Potentiometer (XDCP™) Low Noise, Low Power, SPI™ Bus, 128 Taps

FN6180
 Rev 2.00
 September 8, 2009

Features

- Two potentiometers in one package
- 128 resistor taps
- SPI serial interface
- Non-volatile storage of wiper position
- Wiper resistance: 70Ω typical @ $V_{CC} = 3.3V$
- Shutdown mode
- Shutdown current 5μA max
- Power supply: 2.7V to 5.5V
- 50kΩ or 10kΩ total resistance
- High reliability
 - Endurance: 1,000,000 data changes per bit per register
 - Register data retention: 50 years @ $T \leq +55^{\circ}C$
- 14 Ld TSSOP and 16 Ld QFN package
- Pb-free (RoHS compliant)

The ISL22426 integrates two digitally controlled potentiometers (DCP) and non-volatile memory on a monolithic CMOS integrated circuit.

The digitally controlled potentiometers are implemented with a combination of resistor elements and CMOS switches. The position of the wipers are controlled by the user through the SPI serial interface. Each potentiometer has an associated volatile Wiper Register (WR) and a non-volatile Initial Value Register (IVR) that can be directly written to and read by the user. The contents of the WR controls the position of the wiper. At power-up, the device recalls the contents of the DCP's IVR to the corresponding WR.

The DCPs can be used as three-terminal potentiometers or as two-terminal variable resistors in a wide variety of applications including control, parameter adjustments, and signal processing.

Pinouts

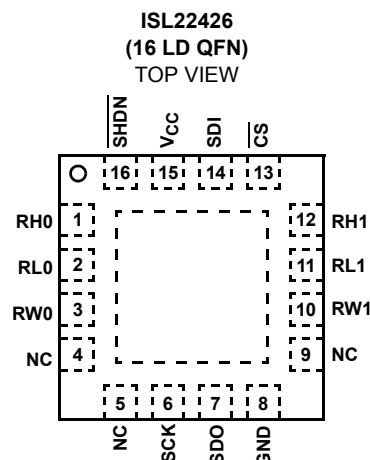
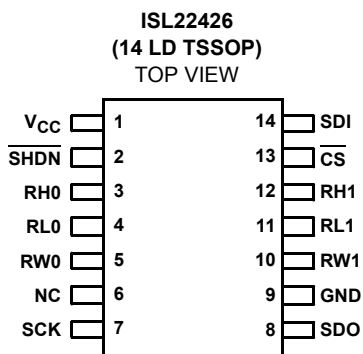

Ordering Information

PART NUMBER (Note)	PART MARKING	RESISTANCE OPTION (kΩ)	TEMP. RANGE (°C)	PACKAGE (Pb-free)	PKG. DWG. #
ISL22426UFV14Z*	22426 UFVZ	50	-40 to +125	14 Ld TSSOP	M14.173
ISL22426UFR16Z*	224 26UFZ	50	-40 to +125	16 Ld 4x4 QFN	L16.4x4A
ISL22426WV14Z*	22426 WVZ	10	-40 to +125	14 Ld TSSOP	M14.173
ISL22426WFR16Z*	224 26WFZ	10	-40 to +125	16 Ld 4x4 QFN	L16.4x4A

*Add "-TK" suffix for tape and reel. Please refer to TB347 for details on reel specifications.

NOTE: These Intersil Pb-free plastic packaged products employ special Pb-free material sets, molding compounds/die attach materials, and 100% matte tin plate plus anneal (e3 termination finish, which is RoHS compliant and compatible with both SnPb and Pb-free soldering operations). Intersil Pb-free products are MSL classified at Pb-free peak reflow temperatures that meet or exceed the Pb-free requirements of IPC/JEDEC J STD-020.

Block Diagram

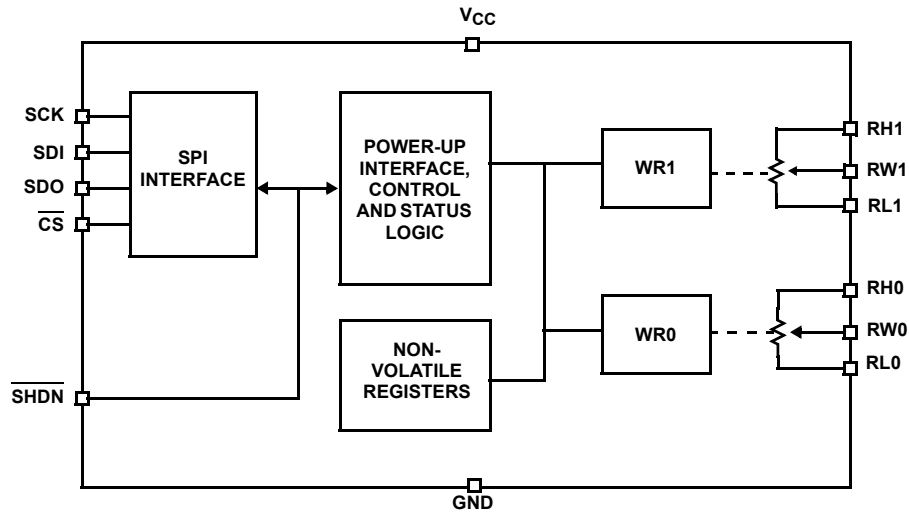

Pin Descriptions

TSSOP PIN NUMBER	QFN PIN NUMBER	SYMBOL	DESCRIPTION
1	15	V_{CC}	Power supply pin
2	16	\overline{SHDN}	Shutdown active low input
3	1	RH0	"High" terminal of DCP0
4	2	RL0	"Low" terminal of DCP0
5	3	RW0	"Wiper" terminal of DCP0
6	4, 5, 9	NC	No connect
7	6	SCK	SPI interface clock input
8	7	SDO	Open drain SPI interface Data Output
9	8	GND	Device ground pin
10	10	RW1	"Wiper" terminal of DCP1
11	11	RL1	"Low" terminal of DCP1
12	12	RH1	"High" terminal of DCP1
13	13	\overline{CS}	Chip Select active low input
14	14	SDI	SPI interface Data Input
	EPAD*		Exposed Die Pad internally connected to GND

*NOTE: PCB thermal land for QFN EPAD should be connected to GND plane or left floating. For more information refer to <http://www.intersil.com/data/tb/TB389.pdf>

Absolute Maximum Ratings

Storage Temperature	-65°C to +150°C
Voltage at any Digital Interface Pin with Respect to GND	-0.3V to $V_{CC} + 0.3$
V_{CC}	-0.3V to +6V
Voltage at any DCP Pin with Respect to GND	-0.3V to V_{CC}
I_W (10s)	± 6 mA
Latchup (Note 4)	Class II, Level B @ +125°C
ESD Ratings	
Human Body Model	2.5kV
Machine Model	.350V

Thermal Information

Thermal Resistance (Typical)	θ_{JA} (°C/W)	θ_{JC} (°C/W)
14 Lead TSSOP (Note 1)	100	N/A
16 Lead QFN (Notes 2, 3)	40	3.0
Maximum Junction Temperature (Plastic Package)	+150°C	
Pb-free Reflow Profile	see link below http://www.intersil.com/pbfree/Pb-FreeReflow.asp	

Recommended Operating Conditions

Temperature Range (Extended Industrial)	-40°C to +125°C
V_{CC}	2.7V to 5.5V
Power Rating	15mW
Wiper Current	± 3.0 mA

CAUTION: Do not operate at or near the maximum ratings listed for extended periods of time. Exposure to such conditions may adversely impact product reliability and result in failures not covered by warranty.

NOTES:

- θ_{JA} is measured with the component mounted on a high effective thermal conductivity test board in free air. See Tech Brief TB379 for details.
- θ_{JA} is measured in free air with the component mounted on a high effective thermal conductivity test board with "direct attach" features. See Tech Brief TB379.
- For θ_{JC} , the "case temp" location is the center of the exposed metal pad on the package underside.
- Jedec Class II pulse conditions and failure criterion used. Level B exceptions are: using a max positive pulse of 6.5V on the SHDN pin, and using a max negative pulse of -0.8V for all pins.

Analog Specifications Over recommended operating conditions, unless otherwise stated.

SYMBOL	PARAMETER	TEST CONDITIONS	MIN (Note 22)	TYP (Note 5)	MAX (Note 22)	UNIT
R_{TOTAL}	R_H to R_L Resistance	W option		10		k Ω
		U option		50		k Ω
	R_H to R_L Resistance Tolerance	W and U option	-20		+20	%
	End-to-End Temperature Coefficient	W option			± 50	
U option				± 80		ppm/°C (Note 21)
V_{RH} ; V_{RL}	V_{RH} and V_{RL} Terminal Voltages	V_{RH} and V_{RL} to GND	0		V_{CC}	V
R_W	Wiper Resistance	$V_{CC} = 3.3V$, wiper current = V_{CC}/R_{TOTAL}		70	200	Ω
$C_H/C_L/C_W$ (Note 21)	Potentiometer Capacitance			10/10/25		pF
I_{LkgDCP}	Leakage on DCP Pins	Voltage at pin from GND to V_{CC}		0.1	1	μA
VOLTAGE DIVIDER MODE (0V @ R_L ; V_{CC} @ R_H ; measured at R_{Wi} , unloaded; $i = 0$ or 1)						
INL (Note 10)	Integral Non-linearity	Monotonic over all tap positions, W and U options	-1		1	LSB (Note 6)
DNL (Note 9)	Differential Non-linearity	Monotonic over all tap positions, W and U options	-0.5		0.5	LSB (Note 6)
ZSerror (Note 7)	Zero-scale Error	W option	0	1	5	LSB (Note 6)
		U option	0	0.5	2	LSB (Note 6)
FSerror (Note 8)	Full-scale Error	W option	-5	-1	0	LSB (Note 6)
		U option	-2	-1	0	LSB (Note 6)

Analog Specifications Over recommended operating conditions, unless otherwise stated. (Continued)

SYMBOL	PARAMETER	TEST CONDITIONS	MIN (Note 22)	TYP (Note 5)	MAX (Note 22)	UNIT
V_{MATCH} (Note 11)	DCP to DCP Matching	Any two DCPs at same tap position, same voltage at all R_{Hi} terminals, and same voltage at all R_{Li} terminals	-2		2	LSB (Note 6)
TC_V (Note 12)	Ratiometric Temperature Coefficient	DCP register set to 40 hex		±4		ppm/°C
RESISTOR MODE (Measurements between R_{Wi} and R_{Li} with R_{Hi} not connected, or between R_{Wi} and R_{Hi} with R_{Li} not connected; $i = 0$ or 1)						
R_{INL} (Note 16)	Integral Non-linearity	DCP register set between 10h and 7Fh; monotonic over all tap positions	-1		1	MI (Note 13)
R_{DNL} (Note 15)	Differential Non-linearity	DCP register set between 10h and 7Fh; monotonic over all tap positions, W option	-1		1	MI (Note 13)
		DCP register set between 10h and 7Fh; monotonic over all tap positions, U option	-0.5		0.5	MI (Note 13)
Roffset (Note 14)	Offset	W option	0	1	7	MI (Note 13)
		U option	0	0.5	2	MI (Note 13)
R_{MATCH} (Note 17)	DCP to DCP Matching	Any two DCPs at the same tap position with the same terminal voltages	-2		2	MI (Note 13)

Operating Specifications Over the recommended operating conditions, unless otherwise specified.

SYMBOL	PARAMETER	TEST CONDITIONS	MIN (Note 22)	TYP (Note 5)	MAX (Note 22)	UNIT
I_{CC1}	V_{CC} Supply Current (Volatile Write/Read)	$f_{SCK} = 5\text{MHz}$; (for SPI Active, Read and Volatile Write states only)			0.5	mA
I_{CC2}	V_{CC} Supply Current (Non-volatile Write/Read)	$f_{SCK} = 5\text{MHz}$; (for SPI Active, Read and Non-volatile Write states only)			3	mA
I_{SB}	V_{CC} Current (Standby)	$V_{CC} = +5.5\text{V} @ +85^\circ\text{C}$, SPI interface in standby state			5	µA
		$V_{CC} = +5.5\text{V} @ +125^\circ\text{C}$, SPI interface in standby state			7	µA
		$V_{CC} = +3.6\text{V} @ +85^\circ\text{C}$, SPI interface in standby state			3	µA
		$V_{CC} = +3.6\text{V} @ +125^\circ\text{C}$, SPI interface in standby state			5	µA
I_{SD}	V_{CC} Current (Shutdown)	$V_{CC} = +5.5\text{V} @ +85^\circ\text{C}$, SPI interface in standby state			3	µA
		$V_{CC} = +5.5\text{V} @ +125^\circ\text{C}$, SPI interface in standby state			5	µA
		$V_{CC} = +3.6\text{V} @ +85^\circ\text{C}$, SPI interface in standby state			2	µA
		$V_{CC} = +3.6\text{V} @ +125^\circ\text{C}$, SPI interface in standby state			4	µA
I_{LkgDig}	Leakage Current, at Pins \overline{SHDN} , SCK, SDI, SDO and \overline{CS}	Voltage at pin from GND to V_{CC}	-1		1	µA
t_{WRT} (Note 21)	Wiper Response Time After SPI Write to WR Register			1.5		µs

Operating Specifications Over the recommended operating conditions, unless otherwise specified. (Continued)

SYMBOL	PARAMETER	TEST CONDITIONS	MIN (Note 22)	TYP (Note 5)	MAX (Note 22)	UNIT
t_{ShdnRec} (Note 21)	DCP Recall Time From Shutdown Mode	From rising edge of $\overline{\text{SHDN}}$ signal to wiper stored position and RH connection		1.5		μs
		SCK rising edge of last bit of ACR data byte to wiper stored position and RH connection		1.5		μs
V_{por}	Power-on Recall Voltage	Minimum V_{CC} at which memory recall occurs	2.0		2.6	V
V_{ccRamp}	V_{CC} Ramp Rate		0.2			V/ms
t_{D}	Power-up Delay	V_{CC} above V_{por} , to DCP Initial Value Register recall completed, and SPI Interface in standby state			3	ms
EEPROM SPECIFICATION						
	EEPROM Endurance		1,000,000			Cycles
	EEPROM Retention	Temperature $T \leq +55^{\circ}\text{C}$	50			Years
t_{WC} (Note 19)	Non-volatile Write Cycle Time			12	20	ms
SERIAL INTERFACE SPECIFICATIONS						
V_{IL}	$\overline{\text{SHDN}}$, SCK, SDI, and $\overline{\text{CS}}$ Input Buffer LOW Voltage		-0.3		$0.3 \cdot V_{\text{CC}}$	V
V_{IH}	$\overline{\text{SHDN}}$, SCK, SDI, and $\overline{\text{CS}}$ Input Buffer HIGH Voltage		$0.7 \cdot V_{\text{CC}}$		$V_{\text{CC}} + 0.3$	V
Hysteresis	$\overline{\text{SHDN}}$, SCK, SDI, and $\overline{\text{CS}}$ Input Buffer Hysteresis		$0.05 \cdot V_{\text{CC}}$			V
V_{OL}	SDO Output Buffer LOW Voltage	$I_{\text{OL}} = 4\text{mA}$	0		0.4	V
R_{pu} (Note 20)	SDO Pull-up Resistor Off-chip	Maximum is determined by t_{RO} and t_{FO} with maximum bus load $C_b = 30\text{pF}$, $f_{\text{SCK}} = 5\text{MHz}$			2	$\text{k}\Omega$
C_{pin} (Note 21)	$\overline{\text{SHDN}}$, SCK, SDI, SDO and $\overline{\text{CS}}$ Pin Capacitance			10		pF
f_{SCK}	SPI Frequency				5	MHz
t_{CYC}	SPI Clock Cycle Time		200			ns
t_{WH}	SPI Clock High Time		100			ns
t_{WL}	SPI Clock Low Time		100			ns
t_{LEAD}	Lead Time		250			ns
t_{LAG}	Lag Time		250			ns
t_{SU}	SDI, SCK and $\overline{\text{CS}}$ Input Set-up Time		50			ns
t_{H}	SDI, SCK and $\overline{\text{CS}}$ Input Hold Time		50			ns
t_{RI}	SDI, SCK and $\overline{\text{CS}}$ Input Rise Time		10			ns
t_{FI}	SDI, SCK and $\overline{\text{CS}}$ Input Fall Time		10		20	ns
t_{DIS}	SDO Output Disable Time		0		100	ns
t_{V}	SDO Output Valid Time				350	ns
t_{HO}	SDO Output Hold Time		0			ns
t_{RO}	SDO Output Rise Time	$R_{\text{pu}} = 2\text{k}$, $C_b = 30\text{pF}$			60	ns

Operating Specifications Over the recommended operating conditions, unless otherwise specified. (Continued)

SYMBOL	PARAMETER	TEST CONDITIONS	MIN (Note 22)	TYP (Note 5)	MAX (Note 22)	UNIT
t _{FO}	SDO Output Fall Time	R _{pu} = 2k, C _b = 30pF			60	ns
t _{CS}	CS Deselect Time		2			μs

NOTES:

- Typical values are for T_A = +25°C and 3.3V supply voltage.
- LSB: $[V(RW)_{127} - V(RW)_0]/127$. V(RW)₁₂₇ and V(RW)₀ are V(RW) for the DCP register set to 7F hex and 00 hex respectively. LSB is the incremental voltage when changing from one tap to an adjacent tap.
- ZS error = V(RW)₀/LSB.
- FS error = $[V(RW)_{127} - V_{CC}]/LSB$.
- DNL = $[V(RW)_i - V(RW)_{i-1}]/LSB - 1$, for i = 1 to 127. i is the DCP register setting.
- INL = $[V(RW)_i - i \cdot LSB - V(RW)]/LSB$ for i = 1 to 127
- V_{MATCH} = $[V(RWx)_i - V(RWy)_i]/LSB$, for i = 1 to 127, x = 0 or 1 and y = 0 or 1.
- $T_{CV} = \frac{Max(V(RW)_i) - Min(V(RW)_i)}{[Max(V(RW)_i) + Min(V(RW)_i)]/2} \times \frac{10^6}{+165^\circ C}$ for i = 16 to 112 decimal, T = -40°C to +125°C. Max() is the maximum value of the wiper voltage and Min() is the minimum value of the wiper voltage over the temperature range.
- MI = $|RW_{127} - RW_0|/127$. MI is a minimum increment. RW₁₂₇ and RW₀ are the measured resistances for the DCP register set to 7F hex and 00 hex respectively.
- Roffset = RW₀/MI, when measuring between RW and RL.
Roffset = RW₁₂₇/MI, when measuring between RW and RH.
- RDNL = $(RW_i - RW_{i-1})/MI$, for i = 1 to 127.
- RINL = $[RW_i - (MI \cdot i) - RW_0]/MI$, for i = 1 to 127.
- R_{MATCH} = $(RW_{i,x} - RW_{i,y})/MI$, for i = 1 to 127, x = 0 or 1 and y = 0 or 1.
- $T_{CR} = \frac{[Max(Ri) - Min(Ri)]}{[Max(Ri) + Min(Ri)]/2} \times \frac{10^6}{+165^\circ C}$ for i = 16 to 112, T = -40°C to +125°C. Max() is the maximum value of the resistance and Min() is the minimum value of the resistance over the temperature range.
- t_{WC} is the time from the end of a Write sequence of SPI serial interface, to the end of the self-timed internal non-volatile write cycle.
- R_{pu} is specified for the highest data rate transfer for the device. Higher value pull-up can be used at lower data rates.
- Limits should be considered typical and are not production tested.
- Parameters with MIN and/or MAX limits are 100% tested at +25°C, unless otherwise specified. Temperature limits established by characterization and are not production tested.

Timing Diagrams

Input Timing

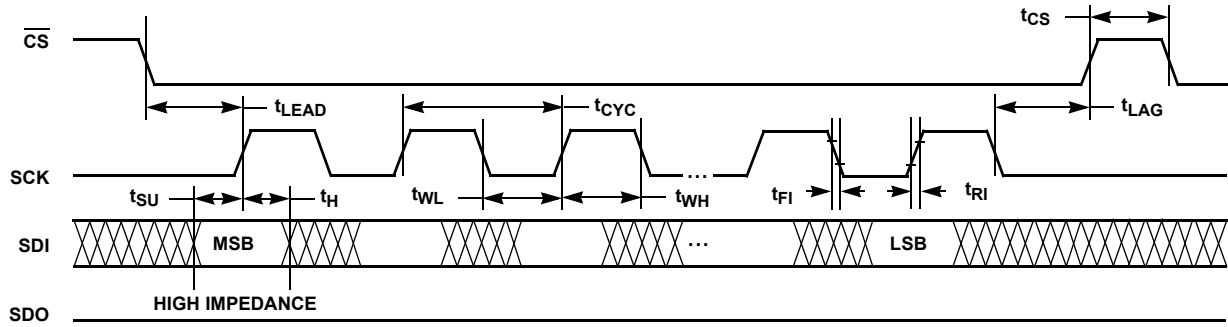

Output Timing

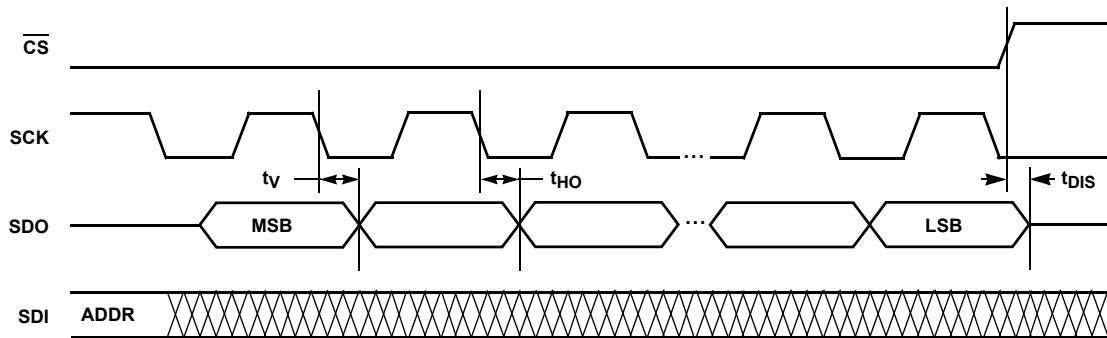

XDCP Timing (for All Load Instructions)

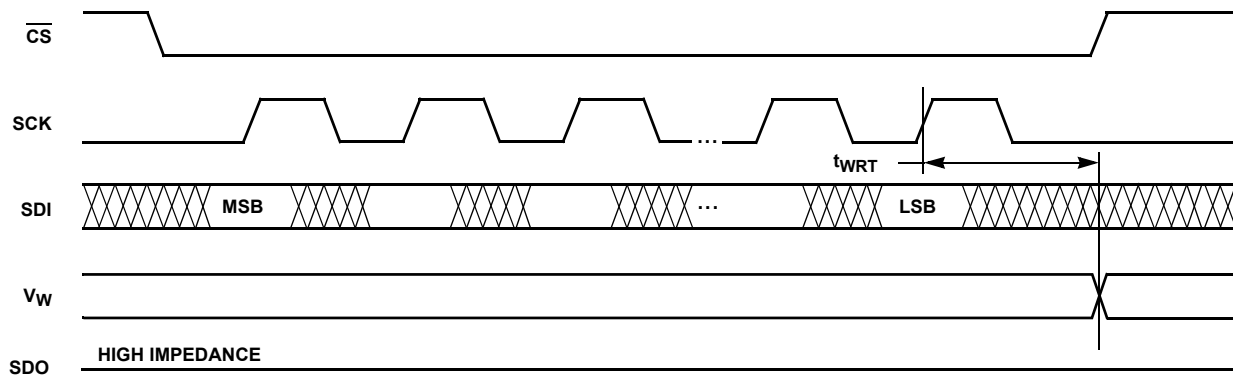

Typical Performance Curves

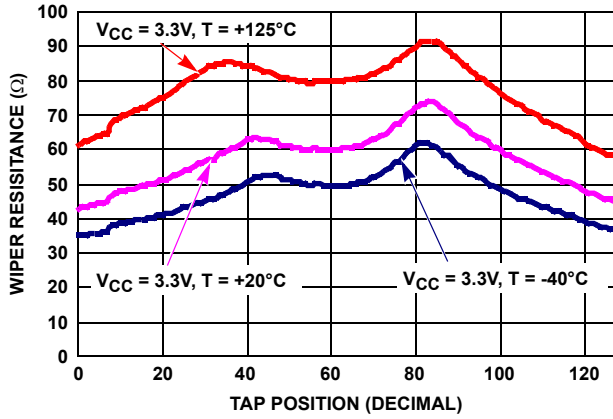

FIGURE 1. WIPER RESISTANCE vs TAP POSITION [$I(RW) = V_{CC}/R_{TOTAL}$] FOR 10kΩ (W)

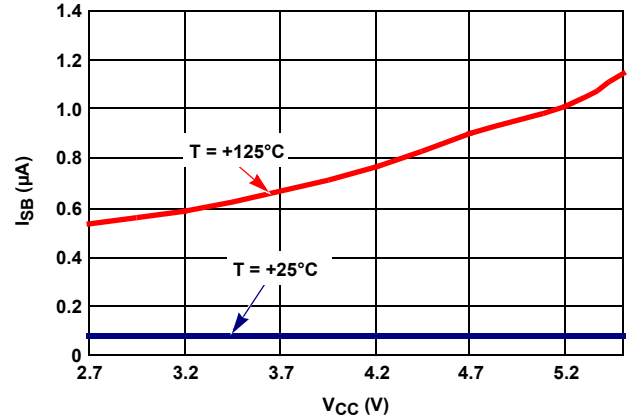

FIGURE 2. STANDBY I_{CC} vs V_{CC}

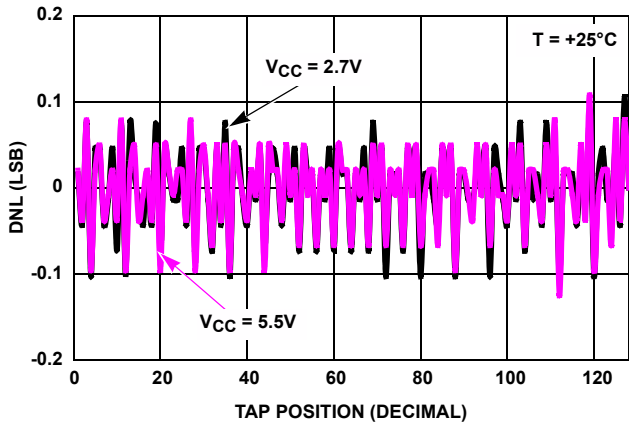

FIGURE 3. DNL vs TAP POSITION IN VOLTAGE DIVIDER MODE FOR 10kΩ (W)

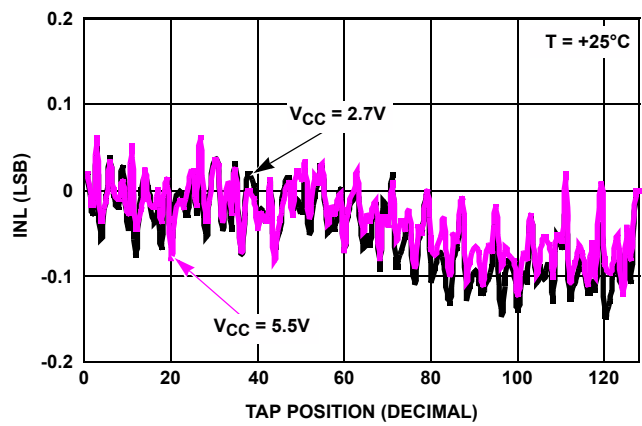

FIGURE 4. INL vs TAP POSITION IN VOLTAGE DIVIDER MODE FOR 10kΩ (W)

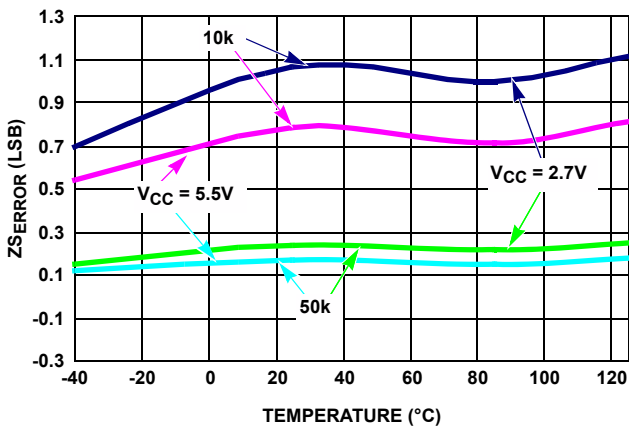

FIGURE 5. ZS_{ERROR} vs TEMPERATURE

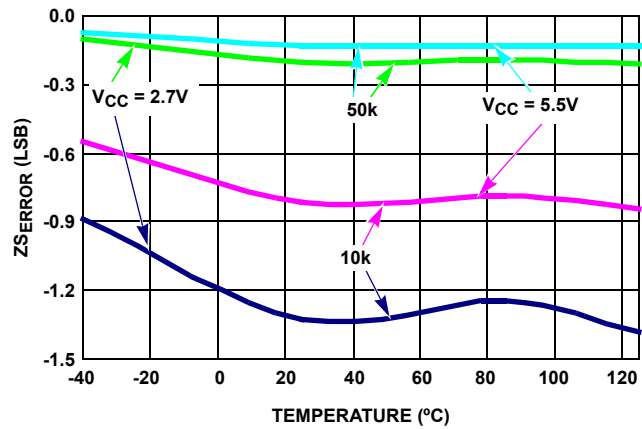

FIGURE 6. FS_{ERROR} vs TEMPERATURE

Typical Performance Curves (Continued)

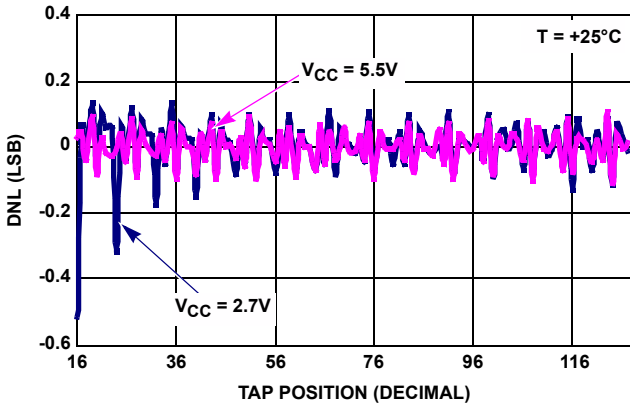

FIGURE 7. DNL vs TAP POSITION IN RHEOSTAT MODE FOR 10kΩ (W)

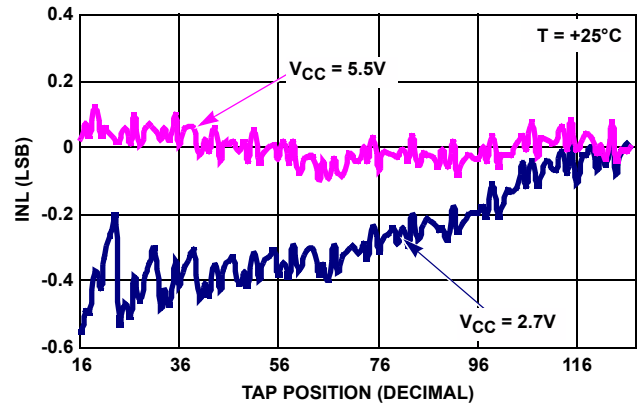

FIGURE 8. INL vs TAP POSITION IN RHEOSTAT MODE FOR 10kΩ (W)

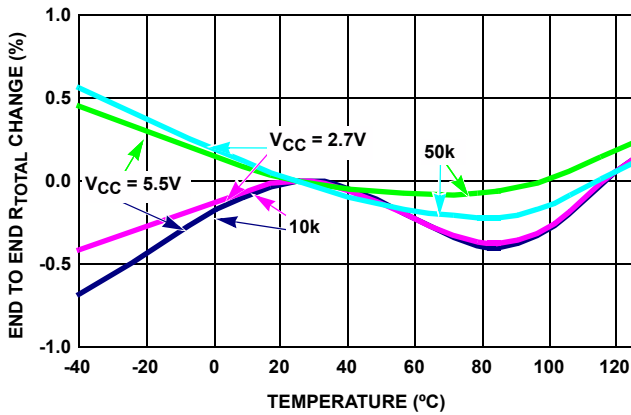

FIGURE 9. END TO END R_{TOTAL} % CHANGE vs TEMPERATURE

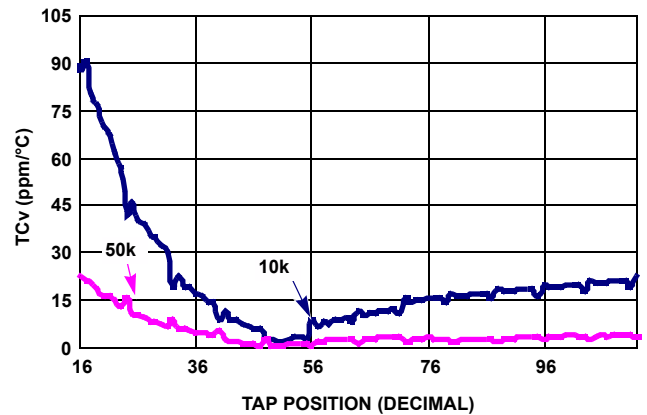

FIGURE 10. TC FOR VOLTAGE DIVIDER MODE IN ppm

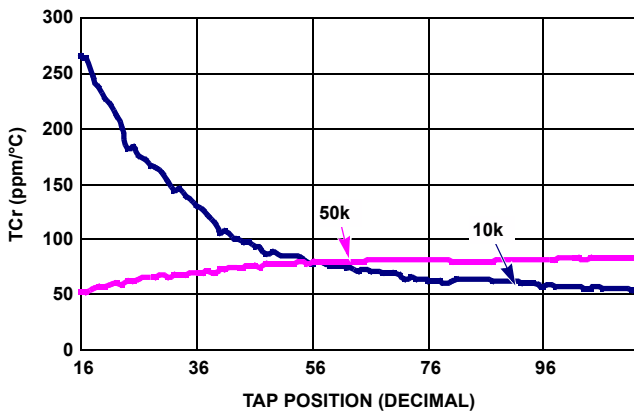

FIGURE 11. TC FOR RHEOSTAT MODE IN ppm

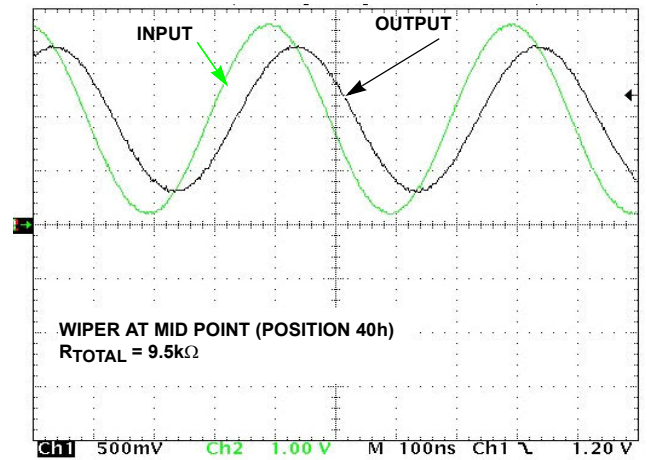

FIGURE 12. FREQUENCY RESPONSE (2.6MHz)

Typical Performance Curves (Continued)

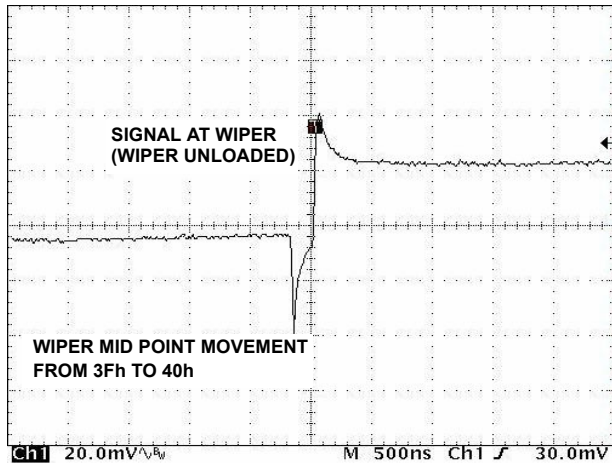

FIGURE 13. MIDSCALE GLITCH, CODE 3Fh TO 40h

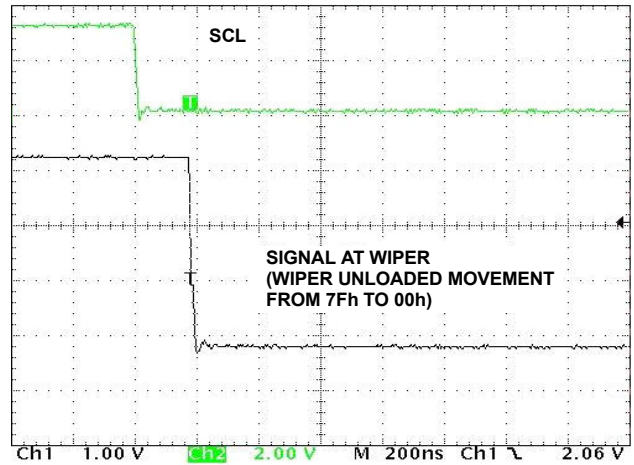

FIGURE 14. LARGE SIGNAL SETTLING TIME

Pin Description

Potentiometer Pins

RHi AND RLi (i = 0, 1)

The high (RHi) and low (RLi) terminals of the ISL22426 are equivalent to the fixed terminals of a mechanical potentiometer. RHi and RLi are referenced to the relative position of the wiper and not the voltage potential on the terminals. With WRi set to 127 decimal, the wiper will be closest to RHi, and with the WRi set to 0, the wiper is closest to RLi.

RWi (i = 0, 1)

RWi is the wiper terminal and is equivalent to the movable terminal of a mechanical potentiometer. The position of the wiper within the array is determined by the WRi register.

SHDN

The SHDN pin forces the resistor to end-to-end open circuit condition on RHi and shorts RWi to RLi. When SHDN is returned to logic high, the previous latch settings put RWi at the same resistance setting prior to shutdown. This pin is logically ANDed with SHDN bit in ACR register. SPI interface is still available in shutdown mode and all registers are accessible. This pin must remain HIGH for normal operation.

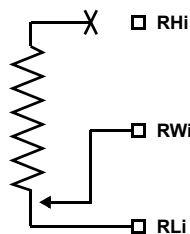

FIGURE 15. DCP CONNECTION IN SHUTDOWN MODE

Bus Interface Pins

SERIAL CLOCK (SCK)

This is the serial clock input of the SPI serial interface.

SERIAL DATA OUTPUT (SDO)

The SDO is an open drain serial data output pin. During a read cycle, the data bits are shifted out at the falling edge of the serial clock SCK, while the CS input is low.

SDO requires an external pull-up resistor for proper operation.

SERIAL DATA INPUT (SDI)

The SDI is the serial data input pin for the SPI interface. It receives device address, operation code, wiper address and data from the SPI external host device. The data bits are shifted in at the rising edge of the serial clock SCK, while the CS input is low.

CHIP SELECT (CS)

CS LOW enables the ISL22426, placing it in the active power mode. A HIGH to LOW transition on CS is required prior to the start of any operation after power up. When CS is HIGH, the ISL22426 is deselected and the SDO pin is at high impedance, and (unless an internal write cycle is underway) the device will be in the standby state.

Principles of Operation

The ISL22426 is an integrated circuit incorporating two DCPs with its associated registers, non-volatile memory and the SPI serial interface providing direct communication between host and potentiometers and memory. The resistor array is comprised of individual resistors connected in series. At either end of the array and between each resistor is an electronic switch that transfers the potential at that point to the wiper.

The electronic switches on the device operate in a “make before break” mode when the wiper changes tap positions.

When the device is powered down, the last value stored in IVR_i will be maintained in the non-volatile memory. When power is restored, the contents of the IVR_i is recalled and loaded into the corresponding WR_i to set the wiper to the initial value.

DCP Description

Each DCP is implemented with a combination of resistor elements and CMOS switches. The physical ends of each DCP are equivalent to the fixed terminals of a mechanical potentiometer (RH and RL pins). The RW pin of each DCP is connected to intermediate nodes, and is equivalent to the wiper terminal of a mechanical potentiometer. The position of the wiper terminal within the DCP is controlled by volatile Wiper Register (WR). Each DCP has its own WR. When the WR of a DCP contains all zeroes (WR[6:0]= 00h), its wiper terminal (RW) is closest to its "Low" terminal (RL). When the WR register of a DCP contains all ones (WR[6:0]= 7Fh), its wiper terminal (RW) is closest to its "High" terminal (RH). As the value of the WR increases from all zeroes (0) to all ones (127 decimal), the wiper moves monotonically from the position closest to RL to the closest to RH. At the same time, the resistance between RW and RL increases monotonically, while the resistance between RH and RW decreases monotonically.

While the ISL22426 is being powered up, all four WRs are reset to 40h (64 decimal), which locates RW roughly at the center between RL and RH. After the power supply voltage becomes large enough for reliable non-volatile memory reading, all WRs will be reload with the value stored in corresponding non-volatile Initial Value Registers (IVRs).

The WRs can be read or written to directly using the SPI serial interface as described in the following sections. The SPI interface register address bits have to be set to 0000b or 0001b to access the WR of DCP0 or DCP1 respectively. The WR_i and IVR_i can be read or written to directly using the SPI serial interface as described in the following sections.

Memory Description

The ISL22426 contains seven non-volatile and three volatile 8-bit registers. The memory map of ISL22426 is shown in Table 1. The two non-volatile registers (IVR_i) at address 0 and 1, contain initial wiper value and volatile registers (WR_i) contain current wiper position. In addition, five non-volatile General Purpose registers from address 2 to address 6 are available.

TABLE 1. MEMORY MAP

ADDRESS	NON-VOLATILE	VOLATILE
8	—	ACR
7	Reserved	
6	General Purpose	Not Available
5	General Purpose	Not Available
4	General Purpose	Not Available
3	General Purpose	Not Available
2	General Purpose	Not Available

TABLE 1. MEMORY MAP (Continued)

ADDRESS	NON-VOLATILE	VOLATILE
1	IVR1	WR1
0	IVR0	WR0

The non-volatile IVR_i and volatile WR_i registers are accessible with the same address.

The Access Control Register (ACR) contains information and control bits described below in Table 2.

The VOL bit (ACR[7]) determines whether the access is to wiper registers WR or initial value registers IVR.

TABLE 2. ACCESS CONTROL REGISTER (ACR)

BIT #	7	6	5	4	3	2	1	0
Bit Name	VOL	SHDN	WIP	0	0	0	0	0

If VOL bit is 0, the non-volatile IVR register is accessible. If VOL bit is 1, only the volatile WR is accessible. Note, value is written to IVR register also is written to the WR. The default value of this bit is 0.

The SHDN bit (ACR[6]) disables or enables Shutdown mode. This bit is logically ANDed with $\overline{\text{SHDN}}$ pin. When this bit is 0, DCP is in Shutdown mode. The default value of SHDN bit is 1.

The WIP bit (ACR[5]) is read only bit. It indicates that non-volatile write operation is in progress. The WIP bit can be read repeatedly after a non-volatile write to determine if the write has been completed. It is impossible to write to the IVR_i, WR_i or ACR while WIP bit is 1.

Shutdown Mode

The device can be put in Shutdown mode either by pulling the $\overline{\text{SHDN}}$ pin to GND or setting the SHDN bit in the ACR register to 0. The truth table for Shutdown mode is in Table 3.

TABLE 3.

$\overline{\text{SHDN}}$ pin	SHDN bit	Mode
High	1	Normal operation
Low	1	Shutdown
High	0	Shutdown
Low	0	Shutdown

SPI Serial Interface

The ISL22426 supports an SPI serial protocol, mode 0. The device is accessed via the SDI input and SDO output with data clocked in on the rising edge of SCK, and clocked out on the falling edge of SCK. $\overline{\text{CS}}$ must be LOW during communication with the ISL22426. SCK and $\overline{\text{CS}}$ lines are controlled by the host or master. The ISL22426 operates only as a slave device.

All communication over the SPI interface is conducted by sending the MSB of each byte of data first.

Protocol Conventions

The first byte sent to the ISL22426 from the SPI host is the Identification Byte. A valid Identification Byte contains 0101 as the four MSBs, with the following four bits set to 0.

TABLE 4. IDENTIFICATION BYTE FORMAT

0	1	0	1	0	0	0	0
(MSB)				(LSB)			

The next byte sent to the ISL22426 contains the instruction and register pointer information. The four MSBs are the instruction and four LSBs are register address (see Table 5).

TABLE 5. IDENTIFICATION BYTE FORMAT

7	6	5	4	3	2	1	0
I3	I2	I1	I0	R3	R2	R1	R0

There are only two valid instruction sets:

1011(binary) - is a Read operation

1100(binary) - is a Write operation

Write Operation

A Write operation to the ISL22426 is a three-byte operation. It first requires the \overline{CS} transition from HIGH to LOW, then a valid Identification Byte, then a valid instruction byte following by Data Byte is sent to SDI pin. The host terminates the write operation by pulling the \overline{CS} pin from LOW to HIGH. For a write to addresses 0000b or 0001b, the MSB at address 8 (ACR[7]) determines if the Data Byte is to be written to volatile or both volatile and non-volatile registers. Refer to “Memory Description” on page 11 and Figure 16.

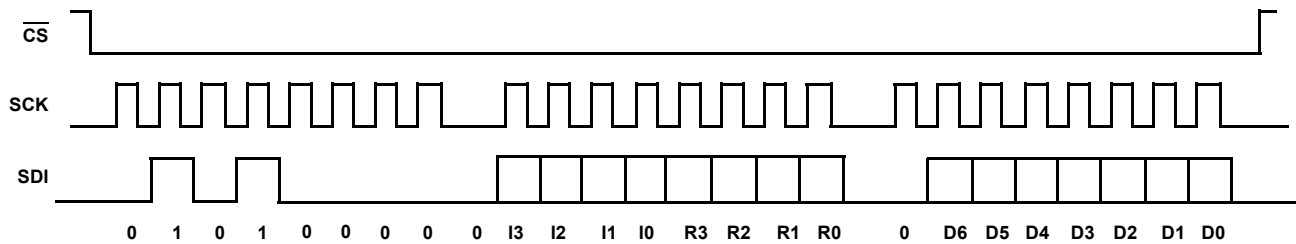

FIGURE 16. THREE BYTE WRITE SEQUENCE

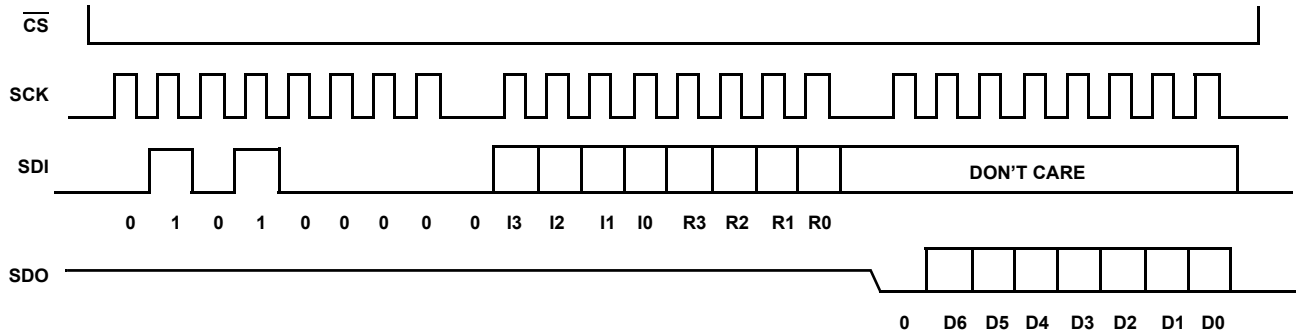

FIGURE 17. THREE BYTE READ SEQUENCE

Device can receive more than one byte of data by auto incrementing the address after each received byte. Note after reaching the address 0110b, the internal pointer “rolls over” to address 0000b.

The internal non-volatile write cycle starts after rising edge of \overline{CS} and takes up to 20ms. Thus, non-volatile registers must be written individually.

Read Operation

A read operation to the ISL22426 is a three-byte operation. It requires first, the \overline{CS} transition from HIGH to LOW, then a valid Identification Byte, then a valid instruction byte following by “dummy” Data Byte is sent to SDI pin. The SPI host reads the data from SDO pin on falling edge of SCK. The host terminates the read operation by pulling the \overline{CS} pin from LOW to HIGH (see Figure 17).

The ISL22426 will provide the Data Bytes to the SDO pin as long as SCK is provided by the host from the registers indicated by an internal pointer. This pointer initial value is determined by the register address in the Read operation instruction, and increments by one during transmission of each Data Byte. After reaching the memory location 0110b, the pointer “rolls over” to 0000b, and the device continues to output the data for each received SCK clock.

In order to read back the non-volatile IVR, it is recommended that the application reads the ACR first to verify the WIP bit is 0. If the WIP bit (ACR[5]) is not 0, the host should repeat its reading sequence again.

Applications Information

Communicating with ISL22426

Communication with ISL22426 proceeds using SPI interface through the ACR (address 1000b), IVRi (addresses 0000b, 0001b) and WRi (addresses 0000b, 0001b) registers.

The wiper of the potentiometer is controlled by the WRi register. Writes and reads can be made directly to these registers to control and monitor the wiper position without any non-volatile memory changes. This is done by setting MSB bit at address 1000b to 1.

The non-volatile IVRi stores the power up value of the wiper. IVRs are accessible when MSB bit at address 1000b is set to 0. Writing a new value to the IVRi register will set a new power-up position for the wiper. Also, writing to this register will load the same value into the corresponding WRi as the IVRi. Reading from the IVRi will not change the WRi, if its contents are different.

Examples

A. Writing to the IVR

This sequence will write a new value (77h) to the IVR0 (non-volatile):

Set the ACR (Addr 1000b) for NV write (40h)

Send the ID byte, Instruction Byte, then the Data byte

0	1	0	1	0	0	0	0	1	1	0	0	1	0	0	0	0	0	1	0	0	0	0	0	0	0	0	0	0	0
---	---	---	---	---	---	---	---	---	---	---	---	---	---	---	---	---	---	---	---	---	---	---	---	---	---	---	---	---	---

(Sent to DI)

Set the IVR0 (Addr 0000b) to 77h

Send the ID byte, Instruction Byte, then the Data byte

0	1	0	1	0	0	0	0	1	1	0	0	0	0	0	0	0	0	0	1	1	1	0	1	1	1	1	1	1	1
---	---	---	---	---	---	---	---	---	---	---	---	---	---	---	---	---	---	---	---	---	---	---	---	---	---	---	---	---	---

(Sent to DI)

B. Reading from the WR

This sequence will read the value from the WR1 (volatile):

Write to ACR first to access the WRs

Send the ID byte, Instruction Byte, then the Data byte

0	1	0	1	0	0	0	0	1	1	0	0	1	0	0	0	0	1	1	0	0	0	0	0	0	0	0	0	0
---	---	---	---	---	---	---	---	---	---	---	---	---	---	---	---	---	---	---	---	---	---	---	---	---	---	---	---	---

(Sent to DI)

Read the data from WR1 (Addr 0001b)

Send the ID byte, Instruction Byte, then Read the Data byte

0	1	0	1	0	0	0	0	1	0	1	1	0	0	0	1	x	x	x	x	x	x	x	x	x	x	x	x	x
---	---	---	---	---	---	---	---	---	---	---	---	---	---	---	---	---	---	---	---	---	---	---	---	---	---	---	---	---

(Out on DO)

**Quad Flat No-Lead Plastic Package (QFN)
Micro Lead Frame Plastic Package (MLFP)**

L16.4x4A

16 LEAD QUAD FLAT NO-LEAD PLASTIC PACKAGE
(COMPLIANT TO JEDEC MO-220-VGGD-10)

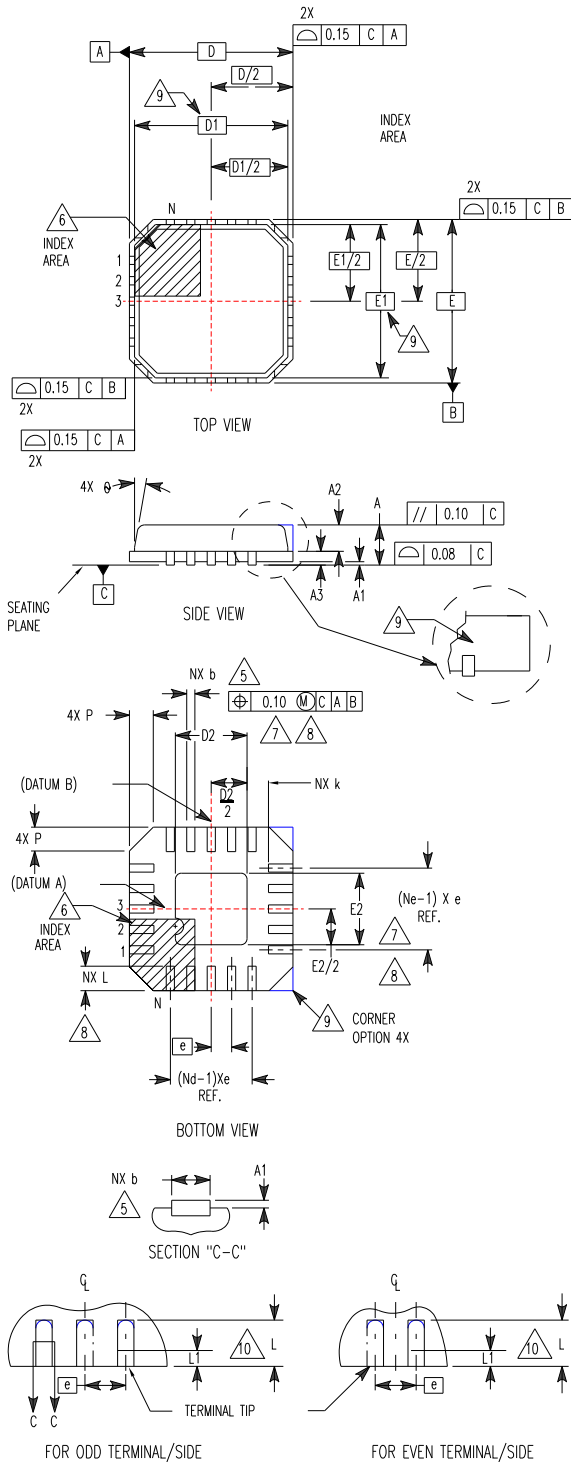

SYMBOL	MILLIMETERS			NOTES
	MIN	NOMINAL	MAX	
A	0.80	0.90	1.00	-
A1	-	-	0.05	-
A2	-	-	1.00	9
A3	0.20 REF			9
b	0.18	0.25	0.30	5, 8
D	4.00 BSC			-
D1	3.75 BSC			9
D2	2.30	2.40	2.55	7, 8
E	4.00 BSC			-
E1	3.75 BSC			9
E2	2.30	2.40	2.55	7, 8
e	0.50 BSC			-
k	0.25	-	-	-
L	0.30	0.40	0.50	8
L1	-	-	0.15	10
N	16			2
Nd	4			3
Ne	4			3
P	-	-	0.60	9
θ	-	-	12	9

Rev. 2 3/06

NOTES:

1. Dimensioning and tolerancing conform to ASME Y14.5-1994.
2. N is the number of terminals.
3. Nd and Ne refer to the number of terminals on each D and E.
4. All dimensions are in millimeters. Angles are in degrees.
5. Dimension b applies to the metallized terminal and is measured between 0.15mm and 0.30mm from the terminal tip.
6. The configuration of the pin #1 identifier is optional, but must be located within the zone indicated. The pin #1 identifier may be either a mold or mark feature.
7. Dimensions D2 and E2 are for the exposed pads which provide improved electrical and thermal performance.
8. Nominal dimensions are provided to assist with PCB Land Pattern Design efforts, see Intersil Technical Brief TB389.
9. Features and dimensions A2, A3, D1, E1, P & θ are present when Anvil singulation method is used and not present for saw singulation.
10. Depending on the method of lead termination at the edge of the package, a maximum 0.15mm pull back (L1) maybe present. L minus L1 to be equal to or greater than 0.3mm.

Thin Shrink Small Outline Plastic Packages (TSSOP)

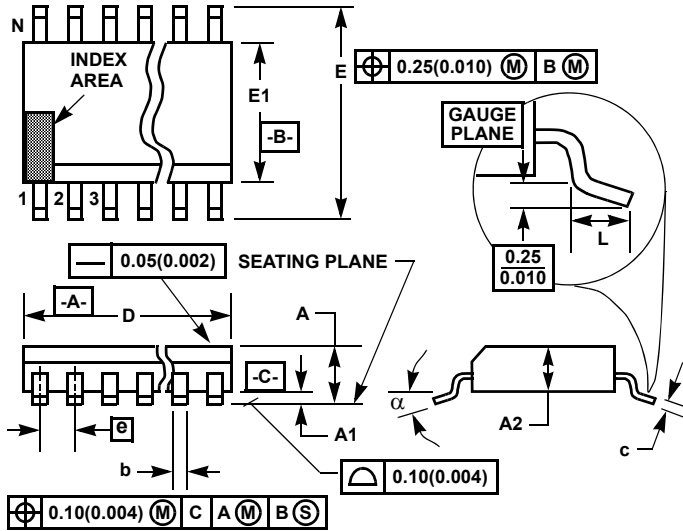

M14.173
14 LEAD THIN SHRINK SMALL OUTLINE PLASTIC PACKAGE

SYMBOL	INCHES		MILLIMETERS		NOTES
	MIN	MAX	MIN	MAX	
A	-	0.047	-	1.20	-
A1	0.002	0.006	0.05	0.15	-
A2	0.031	0.041	0.80	1.05	-
b	0.0075	0.0118	0.19	0.30	9
c	0.0035	0.0079	0.09	0.20	-
D	0.195	0.199	4.95	5.05	3
E1	0.169	0.177	4.30	4.50	4
e	0.026 BSC		0.65 BSC		-
E	0.246	0.256	6.25	6.50	-
L	0.0177	0.0295	0.45	0.75	6
N	14		14		7
α	0°	8°	0°	8°	-

NOTES:

- These package dimensions are within allowable dimensions of JEDEC MO-153-AC, Issue E.
- Dimensioning and tolerancing per ANSI Y14.5M-1982.
- Dimension "D" does not include mold flash, protrusions or gate burrs. Mold flash, protrusion and gate burrs shall not exceed 0.15mm (0.006 inch) per side.
- Dimension "E1" does not include interlead flash or protrusions. Interlead flash and protrusions shall not exceed 0.15mm (0.006 inch) per side.
- The chamfer on the body is optional. If it is not present, a visual index feature must be located within the crosshatched area.
- "L" is the length of terminal for soldering to a substrate.
- "N" is the number of terminal positions.
- Terminal numbers are shown for reference only.
- Dimension "b" does not include dambar protrusion. Allowable dambar protrusion shall be 0.08mm (0.003 inch) total in excess of "b" dimension at maximum material condition. Minimum space between protrusion and adjacent lead is 0.07mm (0.0027 inch).
- Controlling dimension: MILLIMETER. Converted inch dimensions are not necessarily exact. (Angles in degrees)

Rev. 2 4/06

© Copyright Intersil Americas LLC 2006-2009. All Rights Reserved.
 All trademarks and registered trademarks are the property of their respective owners.

For additional products, see www.intersil.com/en/products.html

Intersil products are manufactured, assembled and tested utilizing ISO9001 quality systems as noted in the quality certifications found at www.intersil.com/en/support/qualandreliability.html

Intersil products are sold by description only. Intersil may modify the circuit design and/or specifications of products at any time without notice, provided that such modification does not, in Intersil's sole judgment, affect the form, fit or function of the product. Accordingly, the reader is cautioned to verify that datasheets are current before placing orders. Information furnished by Intersil is believed to be accurate and reliable. However, no responsibility is assumed by Intersil or its subsidiaries for its use; nor for any infringements of patents or other rights of third parties which may result from its use. No license is granted by implication or otherwise under any patent or patent rights of Intersil or its subsidiaries.

For information regarding Intersil Corporation and its products, see www.intersil.com