

## ISL22429

Dual Digitally Controlled Potentiometer (XDCP™) Low Noise, Low Power, SPI® Bus, 128 Taps, Wiper Only

FN6332  
 Rev 2.00  
 May 28, 2009

The ISL22429 integrates two digitally controlled potentiometers (DCP) and non-volatile memory on a monolithic CMOS integrated circuit.

The digitally controlled potentiometers are implemented with a combination of resistor elements and CMOS switches. The position of the wipers are controlled by the user through the SPI serial interface. Each potentiometer has an associated volatile Wiper Register (WR) and a non-volatile Initial Value Register (IVR) that can be directly written to and read by the user. The contents of the WR controls the position of the wiper. At power-up the device recalls the contents of the DCP's IVR to the corresponding WR.

The DCP can be used as a voltage divider in a wide variety of applications including control, parameter adjustments, AC measurement and signal processing.

### Pinout

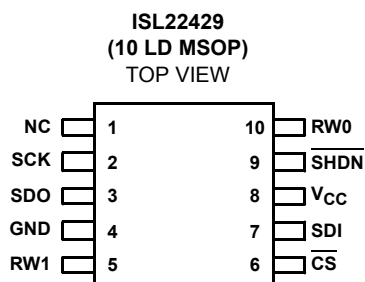

### Features

- Two potentiometers in one package
- 128 resistor taps
- SPI serial interface
- Non-volatile storage of wiper position
- Wiper resistance: 70Ω typical @ 3.3V
- Shutdown mode
- Shutdown current 5μA max
- Power supply: 2.7V to 5.5V
- 50kΩ or 10kΩ total resistance
- High reliability
  - Endurance: 1,000,000 data changes per bit per register
  - Register data retention: 50 years @ T ≤ +55°C
- 10 Lead MSOP
- Pb-free (RoHS compliant)

### Ordering Information

PART NUMBER (Note)	PART MARKING	RESISTANCE OPTION (kΩ)	TEMP. RANGE (°C)	PACKAGE (Pb-free)	PKG. DWG. #
ISL22429UFU10Z*	429UZ	50	-40 to +125	10 Ld MSOP	M10.118
ISL22429WUFU10Z*	429WZ	10	-40 to +125	10 Ld MSOP	M10.118

\*Add "-T" or "-TK" suffix for tape and reel. Please refer to TB347 for details on reel specifications.

NOTE: These Intersil Pb-free plastic packaged products employ special Pb-free material sets, molding compounds/die attach materials, and 100% matte tin plate plus anneal (e3 termination finish, which is RoHS compliant and compatible with both SnPb and Pb-free soldering operations). Intersil Pb-free products are MSL classified at Pb-free peak reflow temperatures that meet or exceed the Pb-free requirements of IPC/JEDEC J STD-020.

## Block Diagram

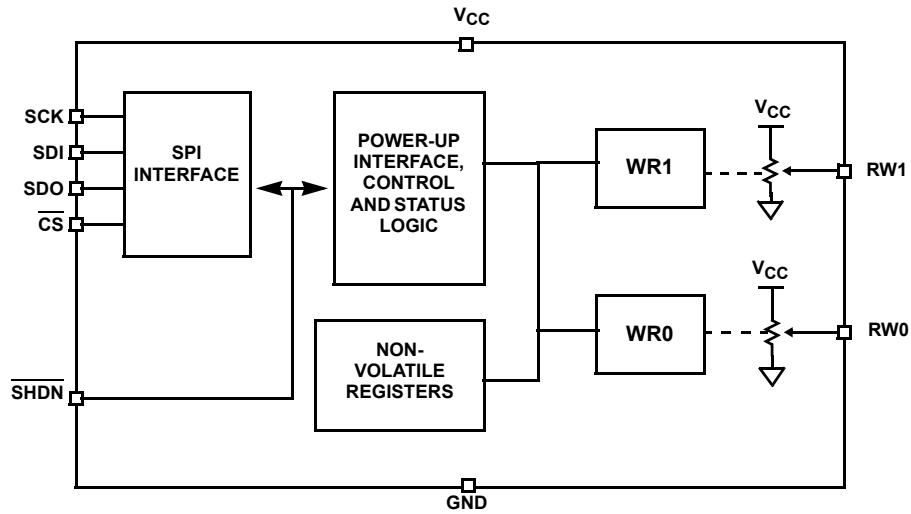

## Pin Descriptions

MSOP PIN	SYMBOL	DESCRIPTION
1	NC	
2	SCK	SPI interface clock input
3	SDO	Open drain SPI interface data output
4	GND	Device ground pin
5	RW1	"Wiper" terminal of DCP1
6	$\overline{\text{CS}}$	Chip Select active low input
7	SDI	SPI interface data input
8	V <sub>CC</sub>	Power supply pin
9	$\overline{\text{SHDN}}$	Shutdown active low input
10	RW0	"Wiper" terminal of DCP0

**Absolute Maximum Ratings**

Storage Temperature	-65°C to +150°C
Voltage at any Digital Interface Pin with Respect to GND	-0.3V to $V_{CC} + 0.3$
$V_{CC}$	-0.3V to +6V
Voltage at any DCP pin with Respect to GND	-0.3V to $V_{CC}$
$I_W$ (10s)	±6mA
Latchup (Note 2)	Class II, Level B @ +125°C
ESD Rating	
HBM	2.5kV
CDM	1kV

**Thermal Information**

Thermal Resistance (Typical, Note 1)	$\theta_{JA}$ (°C/W)
10 Lead MSOP	120
Maximum Junction Temperature (Plastic Package)	+150°C
Pb-Free Reflow Profile	see link below <a href="http://www.intersil.com/pbfree/Pb-FreeReflow.asp">http://www.intersil.com/pbfree/Pb-FreeReflow.asp</a>

**Recommended Operating Conditions**

Ambient Temperature	-40°C to +125°C
$V_{CC}$ Voltage for DCP Operation	2.7V to 5.5V
Wiper Current	-3mA to 3mA
Power Rating	.5mW

**CAUTION:** Do not operate at or near the maximum ratings listed for extended periods of time. Exposure to such conditions may adversely impact product reliability and result in failures not covered by warranty.

**NOTES:**

- $\theta_{JA}$  is measured with the component mounted on a high effective thermal conductivity test board in free air. See Tech Brief TB379 for details.
- Jedec Class II pulse conditions and failure criterion used. Level B exceptions are: using a max positive pulse of 6.5V on the SHDN pin, and using a max negative pulse of -0.8V for all pins.

Analog Specifications Over recommended operating conditions unless otherwise stated. Parameters with MIN and/or MAX limits are 100% tested at +25°C, unless otherwise specified. Temperature limits established by characterization and are not production tested.

SYMBOL	PARAMETER	TEST CONDITIONS	MIN	TYP (Note 3)	MAX	UNIT
R <sub>TOTAL</sub>	End-to-End Resistance	W option		10		k $\Omega$
		U option		50		k $\Omega$
	End-to-End Resistance Tolerance	W and U option	-20		+20	%
	End-to-End Temperature Coefficient	W option		±50		ppm/°C (Note 13)
U option			±80		ppm/°C (Note 13)	
R <sub>W</sub> (Note 13)	Wiper Resistance	$V_{CC} = 3.3V @ +25^\circ C$ , wiper current = $V_{CC}/R_{TOTAL}$		70		$\Omega$
C <sub>W</sub> (Note 13)	Wiper Capacitance			25		pF
<b>VOLTAGE DIVIDER MODE</b> (measured at R <sub>W<i>i</i></sub> , unloaded; i = 0 or 1)						
INL (Note 8)	Integral Non-linearity	Monotonic over all tap positions	-1		1	LSB (Note 4)
DNL (Note 7)	Differential Non-linearity	Monotonic over all tap positions	-0.5		0.5	LSB (Note 4)
ZSerror (Note 5)	Zero-scale Error	W option	0	1	5	LSB (Note 4)
		U option	0	0.5	2	LSB (Note 4)
FSerror (Note 6)	Full-scale Error	W option	-5	-1	0	LSB (Note 4)
		U option	-2	-1	0	LSB (Note 4)
V <sub>MATCH</sub> (Note 9)	DCP to DCP Matching	Any two DCPs at the same tap position	-2		2	LSB (Note 4)
TC <sub>V</sub> (Note 10)	Ratiometric Temperature Coefficient	DCP register set to 40 hex		±4		ppm/°C

**Operating Specifications** Over the recommended operating conditions unless otherwise specified. Parameters with MIN and/or MAX limits are 100% tested at +25°C, unless otherwise specified. Temperature limits established by characterization and are not production tested.

SYMBOL	PARAMETER	TEST CONDITIONS	MIN	TYP (Note 3)	MAX	UNIT
I <sub>CC1</sub>	V <sub>CC</sub> Supply Current (volatile write/read)	10k DCP, f <sub>SPI</sub> = 5MHz; (for SPI active, read and write states)			1.4	mA
	V <sub>CC</sub> Supply Current (volatile write/read)	50k DCP, f <sub>SPI</sub> = 5MHz; (for SPI active, read and write states)			450	μA
I <sub>CC2</sub>	V <sub>CC</sub> Supply Current (non-volatile write/read)	10k DCP, f <sub>SPI</sub> = 5MHz; (for SPI active, read and write states)			3.5	mA
	V <sub>CC</sub> Supply Current (non-volatile write/read)	50k DCP, f <sub>SPI</sub> = 5MHz; (for SPI active, read and write states)			2.0	mA
I <sub>SB</sub>	V <sub>CC</sub> Current (standby)	V <sub>CC</sub> = +5.5V, 10k DCP, SPI interface in standby state			1.22	mA
		V <sub>CC</sub> = +5.5V, 50k DCP, SPI interface in standby state			320	μA
		V <sub>CC</sub> = +3.6V, 10k DCP, SPI interface in standby state			800	μA
		V <sub>CC</sub> = +3.6V, 50k DCP, SPI interface in standby state			250	μA
I <sub>SD</sub>	V <sub>CC</sub> Current (shutdown)	V <sub>CC</sub> = +5.5V @ +85°C, SPI interface in standby state			3	μA
		V <sub>CC</sub> = +5.5V @ +125°C, SPI interface in standby state			5	μA
		V <sub>CC</sub> = +3.6V @ +85°C, SPI interface in standby state			2	μA
		V <sub>CC</sub> = +3.6V @ +125°C, SPI interface in standby state			4	μA
I <sub>LkgDig</sub>	Leakage Current, at Pins $\overline{\text{SHDN}}$ , SCK, SDI, SDO and $\overline{\text{CS}}$	Voltage at pin from GND to V <sub>CC</sub>	-1		1	μA
t <sub>WRT</sub> (Note 13)	Wiper Response Time after SPI Write to WR Register			1.5		μs
t <sub>ShdnRec</sub> (Note 13)	DCP Recall Time from Shutdown Mode	From rising edge of $\overline{\text{SHDN}}$ signal to wiper stored position and RH connection		1.5		μs
		SCK rising edge of last bit of ACR data byte to wiper stored position and RH connection		1.5		μs
V <sub>por</sub>	Power-on Recall Voltage	Minimum V <sub>CC</sub> at which memory recall occurs	2.0		2.6	V
V <sub>ccRamp</sub>	V <sub>CC</sub> Ramp Rate		0.2			V/ms
t <sub>D</sub>	Power-up delay	V <sub>CC</sub> above V <sub>por</sub> , to DCP Initial Value Register recall completed, and SPI Interface in standby state			3	ms
<b>EEPROM SPECIFICATION</b>						
	EEPROM Endurance		1,000,000			Cycles
	EEPROM Retention	Temperature T ≤ +55°C	50			Years
t <sub>WC</sub> (Note 11)	Non-volatile Write Cycle Time			12	20	ms
<b>SERIAL INTERFACE SPECIFICATIONS</b>						
V <sub>IL</sub>	$\overline{\text{SHDN}}$ , SCK, SDI, and $\overline{\text{CS}}$ Input Buffer LOW Voltage		-0.3		0.3*V <sub>CC</sub>	V

**Operating Specifications** Over the recommended operating conditions unless otherwise specified. **(Continued)** Parameters with MIN and/or MAX limits are 100% tested at +25°C, unless otherwise specified. Temperature limits established by characterization and are not production tested. **(Continued)**

SYMBOL	PARAMETER	TEST CONDITIONS	MIN	TYP (Note 3)	MAX	UNIT
V <sub>IH</sub>	$\overline{\text{SHDN}}$ , SCK, SDI, and $\overline{\text{CS}}$ Input Buffer HIGH Voltage		0.7*V <sub>CC</sub>		V <sub>CC</sub> +0.3	V
Hysteresis	$\overline{\text{SHDN}}$ , SCK, SDI, and $\overline{\text{CS}}$ Input Buffer Hysteresis		0.05* V <sub>CC</sub>			V
V <sub>OL</sub>	SDO Output Buffer LOW Voltage	I <sub>OL</sub> = 4mA	0		0.4	V
R <sub>pu</sub> (Note 12)	SDO Pull-up Resistor Off-chip	Maximum is determined by t <sub>RO</sub> and t <sub>FO</sub> with maximum bus load Cbus = 30pF, f <sub>SCK</sub> = 5MHz			2	kΩ
C <sub>pin</sub> (Note 13)	$\overline{\text{SHDN}}$ , SCK, SDI, SDO and $\overline{\text{CS}}$ Pin Capacitance			10		pF
f <sub>SCK</sub>	SPI Frequency				5	MHz
t <sub>CYC</sub>	SPI Clock Cycle Time		200			ns
t <sub>WH</sub>	SPI Clock High Time		100			ns
t <sub>WL</sub>	SPI Clock Low Time		100			ns
t <sub>LEAD</sub>	Lead Time		250			ns
t <sub>LAG</sub>	Lag Time		250			ns
t <sub>SU</sub>	SDI, SCK and $\overline{\text{CS}}$ Input Setup Time		50			ns
t <sub>H</sub>	SDI, SCK and $\overline{\text{CS}}$ Input Hold Time		50			ns
t <sub>RI</sub>	SDI, SCK and $\overline{\text{CS}}$ Input Rise Time		10			ns
t <sub>FI</sub>	SDI, SCK and $\overline{\text{CS}}$ Input Fall Time		10		20	ns
t <sub>DIS</sub>	SDO Output Disable Time		0		100	ns
t <sub>V</sub>	SDO Output Valid Time				350	ns
t <sub>HO</sub>	SDO Output Hold Time		0			ns
t <sub>RO</sub>	SDO Output Rise Time	R <sub>pu</sub> = 2k, Cbus = 30pF			60	ns
t <sub>FO</sub>	SDO Output Fall Time	R <sub>pu</sub> = 2k, Cbus = 30pF			60	ns
t <sub>CS</sub>	CS Deselect Time		2			μs

## NOTES:

- Typical values are for T<sub>A</sub> = +25°C and 3.3V supply voltage.
- LSB: [V(RW)<sub>127</sub> - V(RW)<sub>0</sub>]/127. V(RW)<sub>127</sub> and V(RW)<sub>0</sub> are V(RW) for the DCP register set to 7F hex and 00 hex respectively. LSB is the incremental voltage when changing from one tap to an adjacent tap.
- ZS error = V(RW)<sub>0</sub>/LSB.
- FS error = [V(RW)<sub>127</sub> - V<sub>CC</sub>]/LSB.
- DNL = [V(RW)<sub>i</sub> - V(RW)<sub>i-1</sub>]/LSB-1, for i = 1 to 127. i is the DCP register setting.
- INL = [V(RW)<sub>i</sub> - i • LSB - V(RW)]/LSB for i = 1 to 127
- V<sub>MATCH</sub> = [V(RW)<sub>x</sub> - V(RW)<sub>y</sub>]/LSB, for i = 1 to 127, x = 0 to 3 and y = 0 to 3.
- T<sub>CV</sub> =  $\frac{\text{Max}(V(RW)_i) - \text{Min}(V(RW)_i)}{[\text{Max}(V(RW)_i) + \text{Min}(V(RW)_i)]/2} \times \frac{10^6}{165^\circ\text{C}}$  for i = 16 to 112 decimal, T = -40°C to +125°C. Max( ) is the maximum value of the wiper voltage and Min( ) is the minimum value of the wiper voltage over the temperature range.
- t<sub>WC</sub> is the time from the end of a Write sequence of SPI serial interface, to the end of the self-timed internal non-volatile write cycle.
- R<sub>pu</sub> is specified for the highest data rate transfer for the device. Higher value pull-up can be used at lower data rates.
- This parameter is not 100% tested.

## Timing Diagrams

### Input Timing

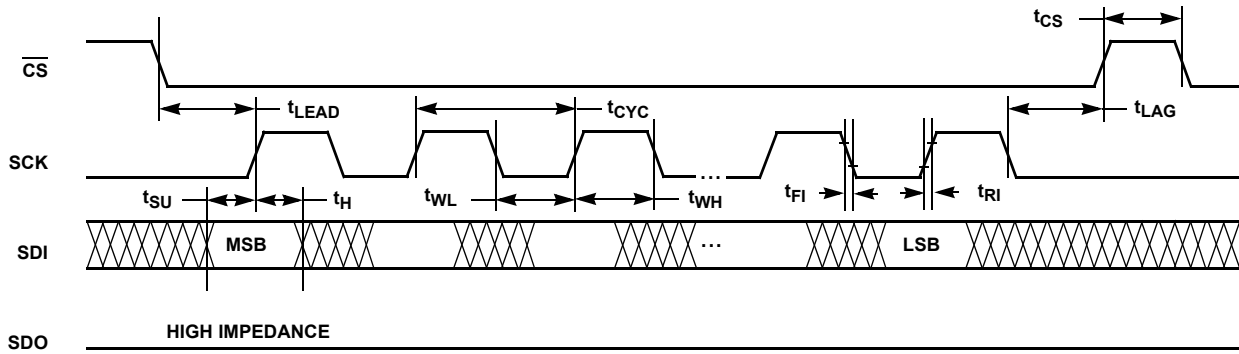

### Output Timing

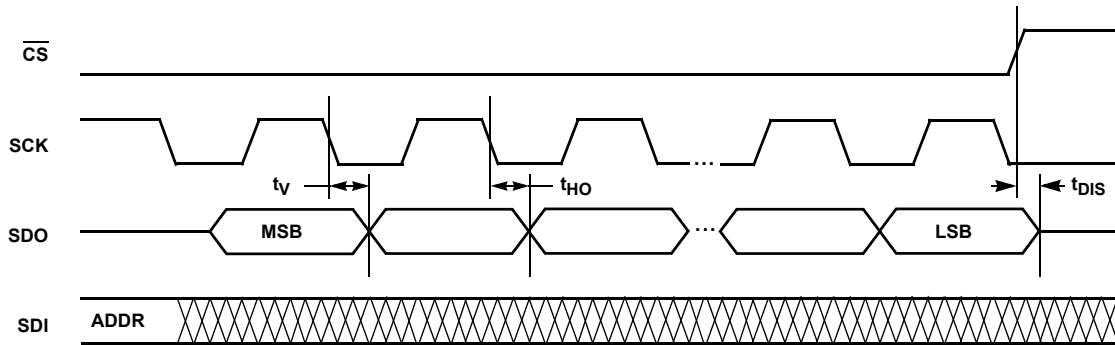

### XDCP Timing (for All Load Instructions)

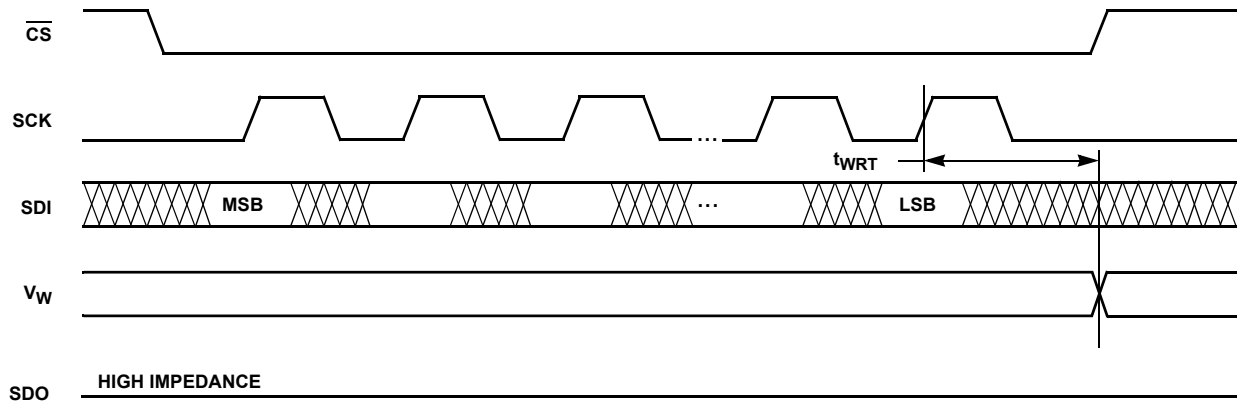

### Typical Performance Curves

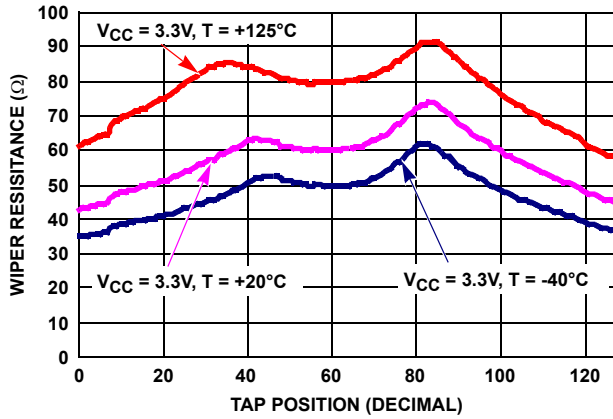

FIGURE 1. WIPER RESISTANCE vs TAP POSITION [  $I(RW) = V_{CC}/R_{TOTAL}$  ] FOR 10kΩ (W)

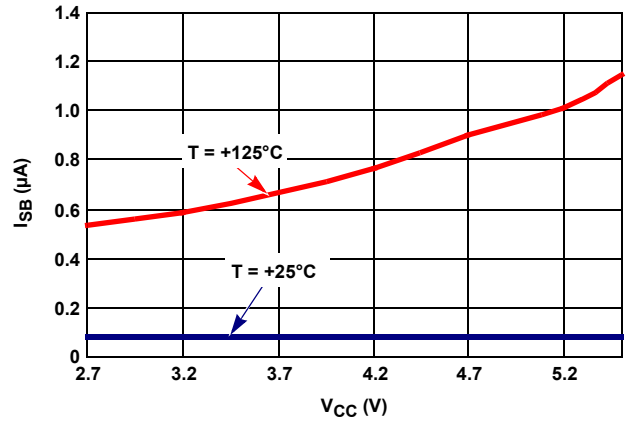

FIGURE 2. STANDBY  $I_{CC}$  vs  $V_{CC}$

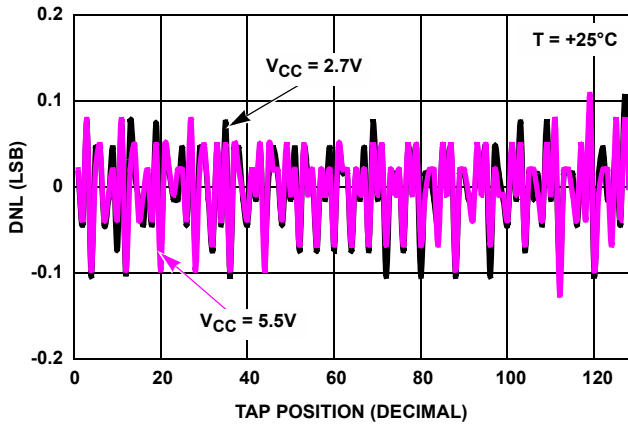

FIGURE 3. DNL vs TAP POSITION IN VOLTAGE DIVIDER MODE FOR 10kΩ (W)

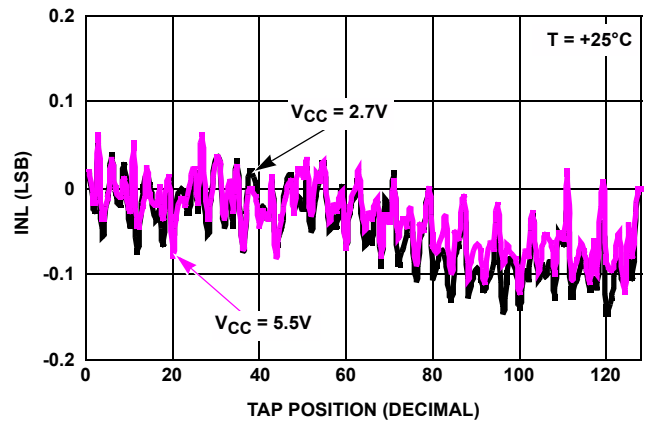

FIGURE 4. INL vs TAP POSITION IN VOLTAGE DIVIDER MODE FOR 10kΩ (W)

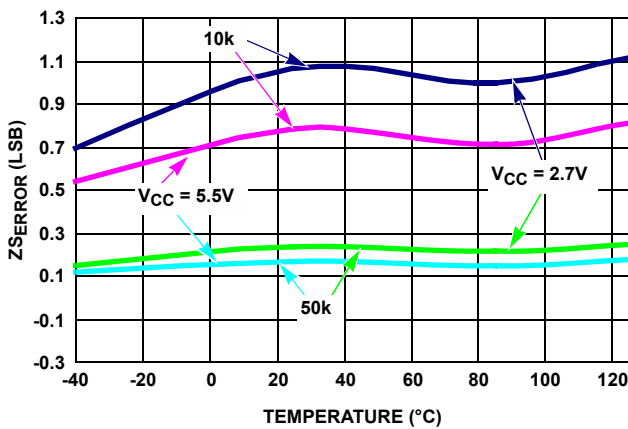

FIGURE 5.  $FS_{ERROR}$  vs TEMPERATURE

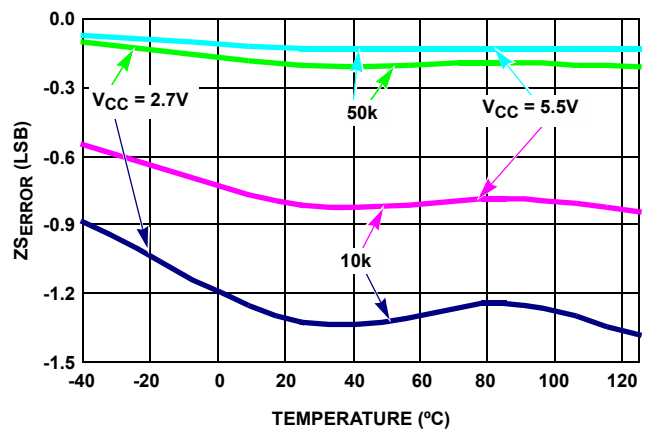

FIGURE 6.  $FS_{ERROR}$  vs TEMPERATURE

**Typical Performance Curves** (Continued)

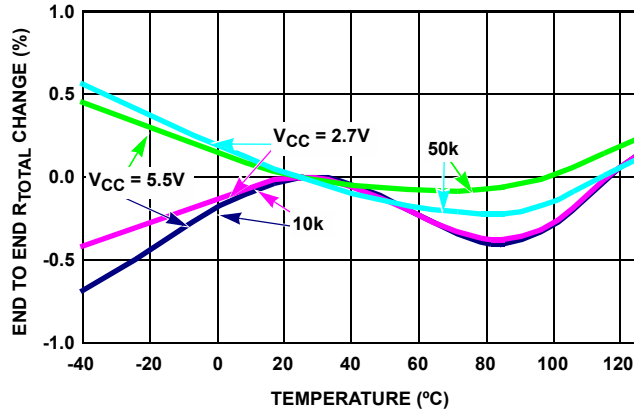

FIGURE 7. END TO END  $R_{TOTAL}$  % CHANGE vs TEMPERATURE

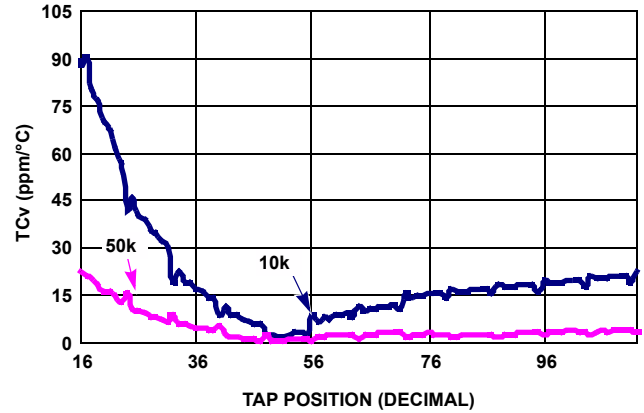

FIGURE 8. TC FOR VOLTAGE DIVIDER MODE IN ppm

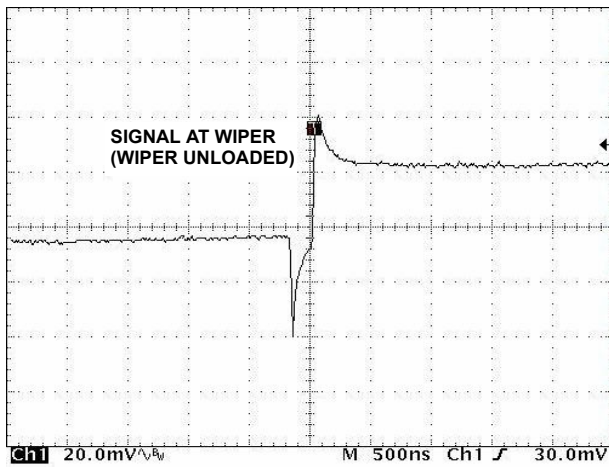

FIGURE 9. MIDSACLE GLITCH, CODE 80h TO 7Fh

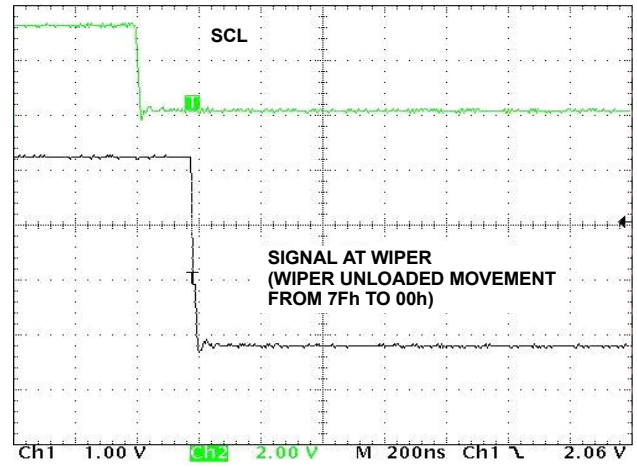

FIGURE 10. LARGE SIGNAL SETTLING TIME

**Pin Description**

**Potentiometer Pins**

**RW<sub>i</sub> (i = 0, 1)**

RW<sub>i</sub> is the wiper terminal and is equivalent to the movable terminal of a mechanical potentiometer. The position of the wiper within the array is determined by the WR<sub>i</sub> register.

**SHDN**

The  $\overline{SHDN}$  pin forces the resistors to end-to-end open circuit condition and shorts RW<sub>i</sub> to GND. When  $\overline{SHDN}$  is returned to logic high, the previous latch settings put RW<sub>i</sub> at the same resistance setting prior to shutdown. This pin is logically AND with SHDN bit in ACR register. SPI interface is still available in shutdown mode and all registers are accessible. This pin must remain HIGH for normal operation.

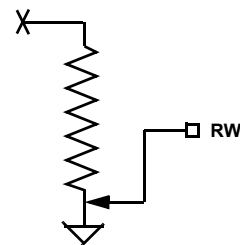

FIGURE 11. DCP CONNECTION IN SHUTDOWN MODE

**Bus Interface Pins**

**SERIAL CLOCK (SCK)**

This is the serial clock input of the SPI serial interface.

**SERIAL DATA OUTPUT (SDO)**

The SDO is an open drain serial data output pin. During a read cycle, the data bits are shifted out at the falling edge of the serial clock SCK, while the  $\overline{CS}$  input is low.

SDO requires an external pull-up resistor for proper operation.



## SERIAL DATA INPUT (SDI)

The SDI is the serial data input pin for the SPI interface. It receives device address, operation code, wiper address and data from the SPI external host device. The data bits are shifted in at the rising edge of the serial clock SCK, while the  $\overline{CS}$  input is low.

## CHIP SELECT ( $\overline{CS}$ )

$\overline{CS}$  LOW enables the ISL22429, placing it in the active power mode. A HIGH to LOW transition on  $\overline{CS}$  is required prior to the start of any operation after power up. When  $\overline{CS}$  is HIGH, the ISL22429 is deselected and the SDO pin is at high impedance, and (unless an internal write cycle is underway) the device will be in the standby state.

## Principles of Operation

The ISL22429 is an integrated circuit incorporating two DCPs with its associated registers, non-volatile memory and the SPI serial interface providing direct communication between host and potentiometers and memory. The resistor array is comprised of individual resistors connected in series. At either end of the array and between each resistor is an electronic switch that transfers the potential at that point to the wiper.

The electronic switches on the device operate in a “make before break” mode when the wiper changes tap positions.

When the device is powered down, the last value stored in IVRi will be maintained in the non-volatile memory. When power is restored, the contents of the IVRi is recalled and loaded into the corresponding WRi to set the wiper to the initial value.

## DCP Description

Each DCP is implemented with a combination of resistor elements and CMOS switches. The physical ends of each DCP are equivalent to the fixed terminals of a mechanical potentiometer and internally connected to Vcc and GND. The RW pin of each DCP is connected to intermediate nodes, and is equivalent to the wiper terminal of a mechanical potentiometer. The position of the wiper terminal within the DCP is controlled by volatile Wiper Register (WR). Each DCP has its own WR. When the WR of a DCP contains all zeroes (WR[6:0] = 00h), its wiper terminal (RW) is closest to GND. When the WR register of a DCP contains all ones (WR[6:0] = 7Fh), its wiper terminal (RW) is closest to V<sub>CC</sub>. As the value of the WR increases from all zeroes (0) to all ones (127 decimal), the wiper moves monotonically from the position closest to GND to the closest to V<sub>CC</sub>.

While the ISL22429 is being powered up, all two WRs are reset to 40h (64 decimal), which locates RW roughly at the center between GND and Vcc. After the power supply voltage becomes large enough for reliable non-volatile memory reading, all WRs will be reload with the value stored in corresponding non-volatile Initial Value Registers (IVRs).

The SPI interface register address bits have to be set to 0000b or 0001b to access the WR of DCP0 or DCP1 respectively. The

WRi and IVRi can be read or written to directly using the SPI serial interface as described in the following sections.

## Memory Description

The ISL22429 contains seven non-volatile and three volatile 8-bit registers. The memory map of ISL22429 is on Table 1. The two non-volatile registers (IVRi) at address 0 and 1, contain initial wiper value and volatile registers (WRi) contain current wiper position. In addition, five non-volatile General Purpose registers from address 2 to address 6 are available.

TABLE 1. MEMORY MAP

ADDRESS	NON-VOLATILE	VOLATILE
8	—	ACR
7	Reserved	
6	General Purpose	Not Available
5	General Purpose	Not Available
4	General Purpose	Not Available
3	General Purpose	Not Available
2	General Purpose	Not Available
1	IVR1	WR1
0	IVR0	WR0

The non-volatile IVRi and volatile WRi registers are accessible with the same address.

The Access Control Register (ACR) contains information and control bits described below in Table 2.

The VOL bit (ACR[7]) determines whether the access is to wiper registers WRi or initial value registers IVRi.

TABLE 2. ACCESS CONTROL REGISTER (ACR)

BIT #	7	6	5	4	3	2	1	0
Bit Name	VOL	SHDN	WIP	0	0	0	0	0

If VOL bit is 0, the non-volatile IVRi register is accessible. If VOL bit is 1, only the volatile WRi is accessible. Note, value is written to IVRi register also is written to the WRi. The default value of this bit is 0.

The SHDN bit (ACR[6]) disables or enables Shutdown mode. This bit is logically AND with SHDN pin. When this bit is 0, DCPs are in Shutdown mode. The default value of SHDN bit is 1.

The WIP bit (ACR[5]) is read only bit. It indicates that non-volatile write operation is in progress. The WIP bit can be read repeatedly after a non-volatile write to determine if the write has been completed. It is impossible to write to the IVRi, WRi or ACR while WIP bit is 1.

## Shutdown Mode

The device can be put in Shutdown mode either by pulling the  $\overline{SHDN}$  pin to GND or setting the SHDN bit in the ACR register to 0. The truth table for Shutdown mode is in Table 3.

TABLE 3.

$\overline{\text{SHDN}}$ pin	SHDN bit	Mode
High	1	Normal operation
Low	1	Shutdown
High	0	Shutdown
Low	0	Shutdown

### SPI Serial Interface

The ISL22429 supports an SPI serial protocol, mode 0. The device is accessed via the SDI input and SDO output with data clocked in on the rising edge of SCK, and clocked out on the falling edge of SCK.  $\overline{\text{CS}}$  must be LOW during communication with the ISL22429. SCK and  $\overline{\text{CS}}$  lines are controlled by the host or master. The ISL22429 operates only as a slave device.

All communication over the SPI interface is conducted by sending the MSB of each byte of data first.

### Protocol Conventions

The first byte sent to the ISL22429 from the SPI host is the Identification Byte. A valid Identification Byte contains 0101 as the four MSBs, with the following four bits set to 0.

TABLE 4. IDENTIFICATION BYTE FORMAT

0	1	0	1	0	0	0	0
(MSB)							(LSB)

The next byte sent to the ISL22429 contains the instruction and register pointer information. The four MSBs are the instruction and four LSBs are register address (see Table 5).

TABLE 5. IDENTIFICATION BYTE FORMAT

7	6	5	4	3	2	1	0
I3	I2	I1	I0	R3	R2	R1	R0

There are only two valid instruction sets:

1011(binary) - is a Read operation

1100(binary) - is a Write operation

### Write Operation

A Write operation to the ISL22429 is a three-byte operation. It requires first, the  $\overline{\text{CS}}$  transition from HIGH to LOW, then a valid Identification Byte, then a valid instruction byte following by Data Byte is sent to SDI pin. The host terminates the write operation by pulling the  $\overline{\text{CS}}$  pin from LOW to HIGH. For a write to addresses 0000b or 0001b, the MSB at address 8 (ACR[7]) determines if the Data Byte is to be written to volatile or both volatile and non-volatile registers. Refer to "Memory Description" on page 9 and Figure 12.

Device can receive more than one byte of data by auto incrementing the address after each received byte. Note after reaching the address 0110b, the internal pointer "rolls over" to address 0000b.

The internal non-volatile write cycle starts after rising edge of  $\overline{\text{CS}}$  and takes up to 20ms. Thus, non-volatile registers must be written individually.

### Read Operation

A read operation to the ISL22429 is a three-byte operation. It requires first, the  $\overline{\text{CS}}$  transition from HIGH to LOW, then a valid Identification Byte, then a valid instruction byte following by "dummy" Data Byte is sent to SDI pin. The SPI host reads the data from SDO pin on falling edge of SCK. The host terminates the read operation by pulling the  $\overline{\text{CS}}$  pin from LOW to HIGH (see Figure 13).

The ISL22429 will provide the Data Bytes to the SDO pin as long as SCK is provided by the host from the registers indicated by an internal pointer. This pointer initial value is determined by the register address in the Read operation instruction, and increments by one during transmission of each Data Byte. After reaching the memory location 0110b, the pointer "rolls over" to 0000b, and the device continues to output the data for each received SCK clock.

In order to read back the non-volatile IVR, it is recommended that the application reads the ACR first to verify the WIP bit is 0. If the WIP bit (ACR[5]) is not 0, the host should repeat its reading sequence again.

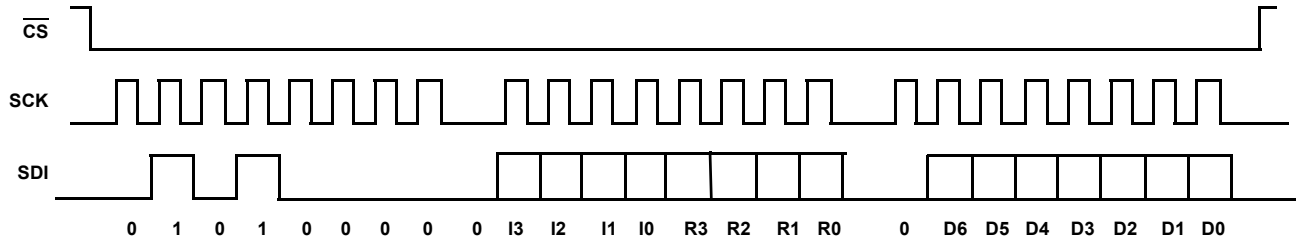

FIGURE 12. THREE BYTE WRITE SEQUENCE

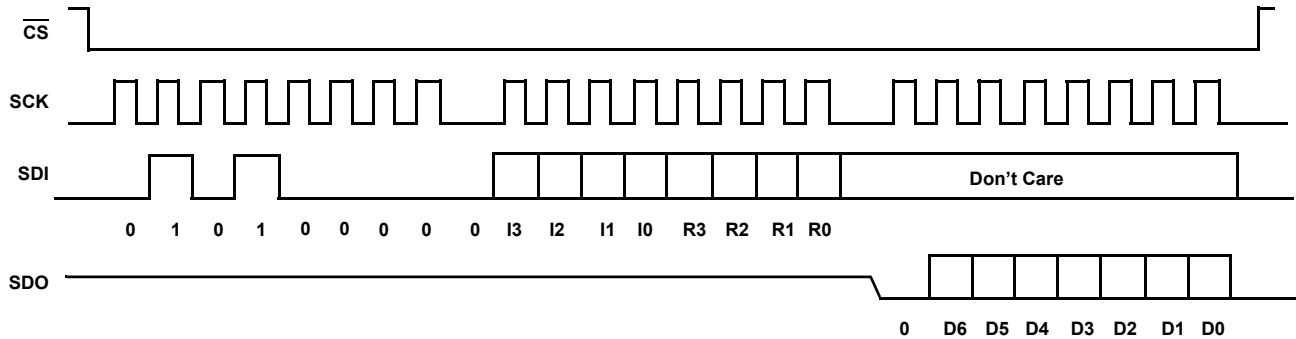

FIGURE 13. THREE BYTE READ SEQUENCE

## Applications Information

### Communicating with ISL22429

Communication with ISL22429 proceeds using SPI interface through the ACR (address 1000b), IVRi (addresses 0000b, 0001b) and WRi (addresses 0000b, 0001b) registers.

The wiper of the potentiometer is controlled by the WRi register. Writes and reads can be made directly to these registers to control and monitor the wiper position without any non-volatile memory changes. This is done by setting MSB bit at address 1000b to 1.

The non-volatile IVRi stores the power up value of the wiper. IVRs are accessible when MSB bit at address 1000b is set to 0. Writing a new value to the IVRi register will set a new power up position for the wiper. Also, writing to this register will load the same value into the corresponding WRi as the IVRi. Reading from the IVRi will not change the WRi, if its contents are different.

**Examples:****B. Reading from the WR:**

This sequence will read the value from the WR1 (volatile):

Write to ACR first to access the volatile WRs

Send the ID byte, Instruction Byte, then the Data byte

0	1	0	1	0	0	0	0	1	1	0	0	1	0	0	0	1	1	0	0	0	0	0	0
---	---	---	---	---	---	---	---	---	---	---	---	---	---	---	---	---	---	---	---	---	---	---	---

(Sent to SDI)

Read the data from WR1 (Addr 0001b)

Send the ID byte, Instruction Byte, then Read the Data byte

0	1	0	1	0	0	0	0	1	0	1	1	0	0	0	1	x	x	x	x	x	x	x	x
---	---	---	---	---	---	---	---	---	---	---	---	---	---	---	---	---	---	---	---	---	---	---	---

(Out on SDO)

**A. Writing to the IVR:**

This sequence will write a new value (77h) to the IVR0(non-volatile):

Set the ACR (Addr 1000b) for NV write (40h)

Send the ID byte, Instruction Byte, then the Data byte

0	1	0	1	0	0	0	0	1	1	0	0	1	0	0	0	0	1	0	0	0	0	0	0
---	---	---	---	---	---	---	---	---	---	---	---	---	---	---	---	---	---	---	---	---	---	---	---

(Sent to SDI)

Set the IVR0 (Addr 0000b) to 77h

Send the ID byte, Instruction Byte, then the Data byte

0	1	0	1	0	0	0	0	1	1	0	0	0	0	0	0	0	1	1	1	0	1	1	1
---	---	---	---	---	---	---	---	---	---	---	---	---	---	---	---	---	---	---	---	---	---	---	---

(Sent to SDI)

© Copyright Intersil Americas LLC 2006-2009. All Rights Reserved.  
All trademarks and registered trademarks are the property of their respective owners.

For additional products, see [www.intersil.com/en/products.html](http://www.intersil.com/en/products.html)

Intersil products are manufactured, assembled and tested utilizing ISO9001 quality systems as noted in the quality certifications found at [www.intersil.com/en/support/qualandreliability.html](http://www.intersil.com/en/support/qualandreliability.html)

*Intersil products are sold by description only. Intersil may modify the circuit design and/or specifications of products at any time without notice, provided that such modification does not, in Intersil's sole judgment, affect the form, fit or function of the product. Accordingly, the reader is cautioned to verify that datasheets are current before placing orders. Information furnished by Intersil is believed to be accurate and reliable. However, no responsibility is assumed by Intersil or its subsidiaries for its use; nor for any infringements of patents or other rights of third parties which may result from its use. No license is granted by implication or otherwise under any patent or patent rights of Intersil or its subsidiaries.*

For information regarding Intersil Corporation and its products, see [www.intersil.com](http://www.intersil.com)

**Mini Small Outline Plastic Packages (MSOP)**

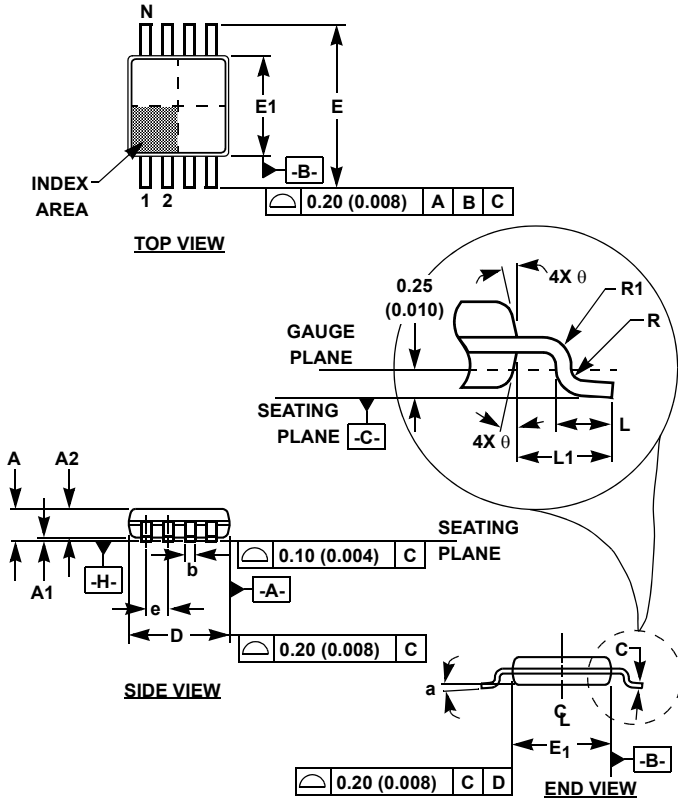

**M10.118 (JEDEC MO-187BA)**  
10 LEAD MINI SMALL OUTLINE PLASTIC PACKAGE

SYMBOL	INCHES		MILLIMETERS		NOTES
	MIN	MAX	MIN	MAX	
A	0.037	0.043	0.94	1.10	-
A1	0.002	0.006	0.05	0.15	-
A2	0.030	0.037	0.75	0.95	-
b	0.007	0.011	0.18	0.27	9
c	0.004	0.008	0.09	0.20	-
D	0.116	0.120	2.95	3.05	3
E1	0.116	0.120	2.95	3.05	4
e	0.020 BSC		0.50 BSC		-
E	0.187	0.199	4.75	5.05	-
L	0.016	0.028	0.40	0.70	6
L1	0.037 REF		0.95 REF		-
N	10		10		7
R	0.003	-	0.07	-	-
R1	0.003	-	0.07	-	-
θ	5°	15°	5°	15°	-
α	0°	6°	0°	6°	-

Rev. 0 12/02

**NOTES:**

1. These package dimensions are within allowable dimensions of JEDEC MO-187BA.
2. Dimensioning and tolerancing per ANSI Y14.5M-1994.
3. Dimension "D" does not include mold flash, protrusions or gate burrs and are measured at Datum Plane. Mold flash, protrusion and gate burrs shall not exceed 0.15mm (0.006 inch) per side.
4. Dimension "E1" does not include interlead flash or protrusions and are measured at Datum Plane. [-H-] Interlead flash and protrusions shall not exceed 0.15mm (0.006 inch) per side.
5. Formed leads shall be planar with respect to one another within 0.10mm (.004) at seating Plane.
6. "L" is the length of terminal for soldering to a substrate.
7. "N" is the number of terminal positions.
8. Terminal numbers are shown for reference only.
9. Dimension "b" does not include dambar protrusion. Allowable dambar protrusion shall be 0.08mm (0.003 inch) total in excess of "b" dimension at maximum material condition. Minimum space between protrusion and adjacent lead is 0.07mm (0.0027 inch).
10. Datums [-A-] and [-B-] to be determined at Datum plane [-H-].
11. Controlling dimension: MILLIMETER. Converted inch dimensions are for reference only