

ISL23318

Single, 128-taps Low Voltage Digitally Controlled Potentiometer (XDCC™)

FN7887
Rev 0.00
July 26, 2011

The ISL23318 is a volatile, low voltage, low noise, low power, I²C Bus™, 128 Taps, single digitally controlled potentiometer (DCP), which integrates DCP core, wiper switches and control logic on a monolithic CMOS integrated circuit.

The digitally controlled potentiometer is implemented with a combination of resistor elements and CMOS switches. The position of the wipers are controlled by the user through the I²C bus interface. The potentiometer has an associated volatile Wiper Register (WR) that can be directly written to and read by the user. The contents of the WR controls the position of the wiper. When powered on, the ISL23318's wiper will always commence at mid-scale (64 tap position).

The low voltage, low power consumption, and small package of the ISL23318 make it an ideal choice for use in battery operated equipment. In addition, the ISL23318 has a V_{LOGIC} pin allowing down to 1.2V bus operation, independent from the V_{CC} value. This allows for low logic levels to be connected directly to the ISL23318 without passing through a voltage level shifter.

The DCP can be used as a three-terminal potentiometer or as a two-terminal variable resistor in a wide variety of applications including control, parameter adjustments, and signal processing.

Features

- 128 resistor taps
- I²C serial interface
 - No additional level translator for low bus supply
 - Two address pins allow up to four devices per bus
- Power supply
 - V_{CC} = 1.7V to 5.5V analog power supply
 - V_{LOGIC} = 1.2V to 5.5V I²C bus/logic power supply
- Wiper resistance: 70Ω typical @ V_{CC} = 3.3V
- Shutdown Mode - forces the DCP into an end-to-end open circuit and R_W is shorted to R_L internally
- Power-on preset to mid-scale (64 tap position)
- Shutdown and standby current <2.8μA max
- DCP terminal voltage from 0V to V_{CC}
- 10kΩ, 50kΩ or 100kΩ total resistance
- Extended industrial temperature range: -40°C to +125°C
- 10 Ld MSOP or 10 Ld UTQFN packages
- Pb-free (RoHS compliant)

Applications

- Gain adjustment in battery powered instruments
- Trimming sensor circuits
- Power supply margining
- RF power amplifier bias compensation

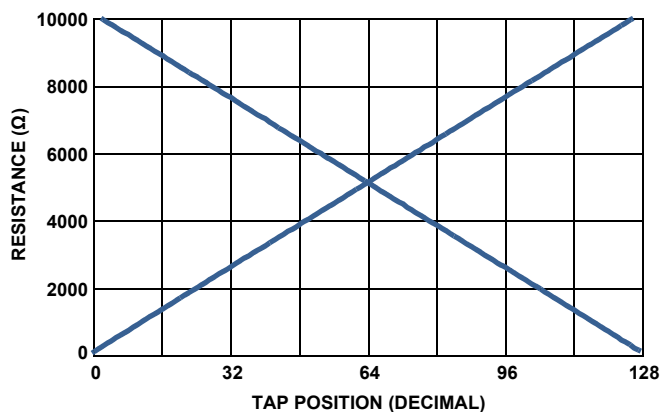

FIGURE 1. FORWARD AND BACKWARD RESISTANCE vs TAP POSITION, 10k DCP

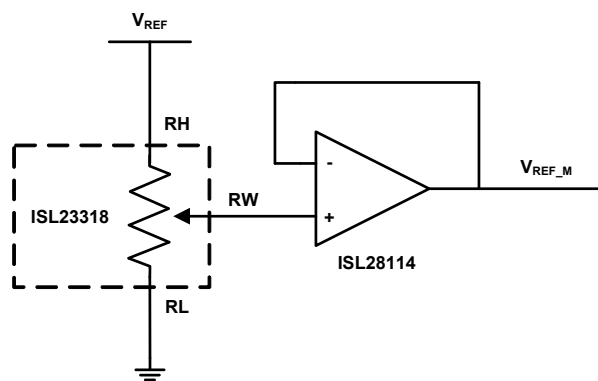
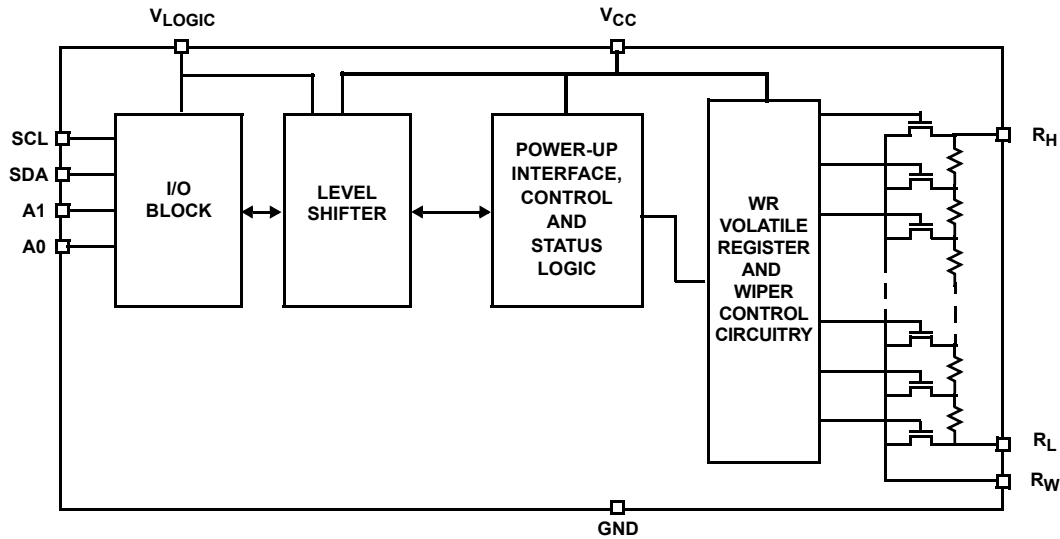
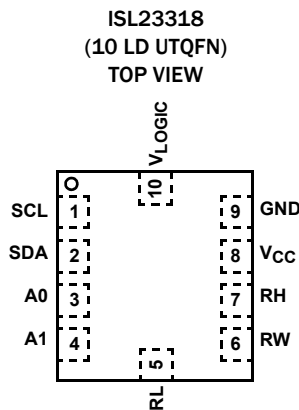
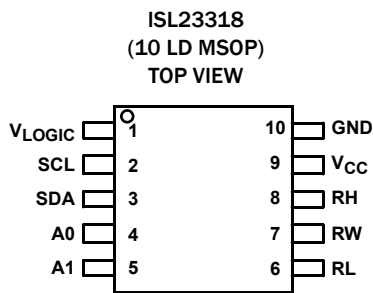

FIGURE 2. V_{REF} ADJUSTMENT

Block Diagram



Pin Configurations



Pin Descriptions

MSOP	UTQFN	SYMBOL	DESCRIPTION
1	10	V _{LOGIC}	I ² C bus /logic supply. Range 1.2V to 5.5V
2	1	SCL	Logic Pin - Serial bus clock input
3	2	SDA	Logic Pin - Serial bus data input/open drain output
4	3	A0	Logic Pin - Hardwire slave address pin for I ² C serial bus. Range: V _{LOGIC} or GND
5	4	A1	Logic Pin - Hardwire slave address pin for I ² C serial bus. Range: V _{LOGIC} or GND
6	5	RL	DCP "low" terminal
7	6	RW	DCP wiper terminal
8	7	RH	DCP "high" terminal
9	8	V _{CC}	Analog power supply. Range 1.7V to 5.5V
10	9	GND	Ground pin

Ordering Information

PART NUMBER (Note 5)	PART MARKING	RESISTANCE OPTION (k Ω)	TEMP RANGE (°C)	PACKAGE (Pb-free)	PKG. DWG. #
ISL23318TFUZ (Notes 1, 3)	3318T	100	-40 to +125	10 Ld MSOP	M10.118
ISL23318UFUZ (Notes 1, 3)	3318U	50	-40 to +125	10 Ld MSOP	M10.118
ISL23318WFUZ (Notes 1, 3)	3318W	10	-40 to +125	10 Ld MSOP	M10.118
ISL23318TFRUZ-T7A (Notes 2, 4)	HH	100	-40 to +125	10 Ld 2.1x1.6 UTQFN	L10.2.1x1.6A
ISL23318TFRUZ-TK (Notes 2, 4)	HH	100	-40 to +125	10 Ld 2.1x1.6 UTQFN	L10.2.1x1.6A
ISL23318UFRUZ-T7A (Notes 2, 4)	HG	50	-40 to +125	10 Ld 2.1x1.6 UTQFN	L10.2.1x1.6A
ISL23318UFRUZ-TK (Notes 2, 4)	HG	50	-40 to +125	10 Ld 2.1x1.6 UTQFN	L10.2.1x1.6A
ISL23318WFRUZ-T7A (Notes 2, 4)	HF	10	-40 to +125	10 Ld 2.1x1.6 UTQFN	L10.2.1x1.6A
ISL23318WFRUZ-TK (Notes 2, 4)	HF	10	-40 to +125	10 Ld 2.1x1.6 UTQFN	L10.2.1x1.6A

NOTES:

1. Add "-TK" or "-T7A" suffix for Tape and Reel option. Please refer to [TB347](#) for details on reel specifications.
2. Please refer to [TB347](#) for details on reel specifications.
3. These Intersil Pb-free plastic packaged products employ special Pb-free material sets, molding compounds/die attach materials, and 100% matte tin plate plus anneal (e3 termination finish, which is RoHS compliant and compatible with both SnPb and Pb-free soldering operations). Intersil Pb-free products are MSL classified at Pb-free peak reflow temperatures that meet or exceed the Pb-free requirements of IPC/JEDEC J STD-020.
4. These Intersil Pb-free plastic packaged products employ special Pb-free material sets; molding compounds/die attach materials and NiPdAu plate-e4 termination finish, which is RoHS compliant and compatible with both SnPb and Pb-free soldering operations. Intersil Pb-free products are MSL classified at Pb-free peak reflow temperatures that meet or exceed the Pb-free requirements of IPC/JEDEC J STD-020.
5. For Moisture Sensitivity Level (MSL), please see device information page for [ISL23318](#). For more information on MSL please see techbrief [TB363](#).

Absolute Maximum Ratings

Supply Voltage Range	
V_{CC}	-0.3V to 6.0V
V_{LOGIC}	-0.3V to 6.0V
Voltage on Any DCP Terminal Pin	-0.3V to 6.0V
Voltage on Any Digital Pins	-0.3V to 6.0V
Wiper current I_W (10s)	± 6 mA
ESD Rating	
Human Body Model (Tested per JESD22-A114E)	6.5kV
CDM Model (Tested per JESD22-A114E)	1kV
Machine Model (Tested per JESD22-A115-A)	200V
Latch Up (Tested per JESD-78B; Class 2, Level A)	100mA @ +125°C

Thermal Information

Thermal Resistance (Typical)	θ_{JA} (°C/W)	θ_{JC} (°C/W)
10 Ld MSOP Package (Notes 6, 7)	170	70
10 Ld UTQFN Package (Notes 6, 7)	145	90
Maximum Junction Temperature (Plastic Package)	+150°C	
Storage Temperature Range	-65°C to +150°C	
Pb-Free Reflow Profile	see link below http://www.intersil.com/pbfree/Pb-FreeReflow.asp	

Recommended Operating Conditions

Temperature	-40°C to +125°C
V_{CC} Supply Voltage	1.7V to 5.5V
V_{LOGIC} Supply Voltage	1.2V to 5.5V
DCP Terminal Voltage	.0 to V_{CC}
Max Wiper Current	± 3 mA

CAUTION: Do not operate at or near the maximum ratings listed for extended periods of time. Exposure to such conditions may adversely impact product reliability and result in failures not covered by warranty.

NOTES:

- θ_{JA} is measured with the component mounted on a high effective thermal conductivity test board in free air. See Tech Brief [TB379](#) for details.
- For θ_{JC} , the "case temp" location is the center top of the package.

Analog Specifications $V_{CC} = 2.7V$ to 5.5V, $V_{LOGIC} = 1.2V$ to 5.5V over recommended operating conditions unless otherwise stated.
Boldface limits apply over the operating temperature range, -40°C to +125°C.

SYMBOL	PARAMETER	TEST CONDITIONS	MIN (Note 20)	TYP (Note 8)	MAX (Note 20)	UNITS
R_{TOTAL}	R_H to R_L Resistance	W option		10		k Ω
		U option		50		k Ω
		T option		100		k Ω
	R_H to R_L Resistance Tolerance		-20	± 2	+20	%
	End-to-End Temperature Coefficient	W option			175	
U option				85		ppm/°C
T option				70		ppm/°C
V_{RH}, V_{RL}	DCP Terminal Voltage	V_{RH} or V_{RL} to GND	0		V_{CC}	V
R_W	Wiper Resistance	R_H - floating, $V_{RL} = 0V$, force I_W current to the wiper, $I_W = (V_{CC} - V_{RL})/R_{TOTAL}$, $V_{CC} = 2.7V$ to 5.5V		70	200	Ω
		$V_{CC} = 1.7V$		580		Ω
$C_H/C_L/C_W$	Terminal Capacitance	See "DCP Macro Model" on page 8		32		pF
I_{LkgDCP}	Leakage on DCP Pins	Voltage at pin from GND to V_{CC}	-0.4	<0.1	0.4	μA
Noise	Resistor Noise Density	Wiper at middle point, W option		16		nV/ \sqrt{Hz}
		Wiper at middle point, U option		49		nV/ \sqrt{Hz}
		Wiper at middle point, T option		61		nV/ \sqrt{Hz}
Feed Thru	Digital Feed-Through from Bus to Wiper	Wiper at middle point		-65		dB
PSRR	Power Supply Reject Ratio	Wiper output change if V_{CC} change $\pm 10\%$; wiper at middle point		-75		dB

Analog Specifications $V_{CC} = 2.7V$ to $5.5V$, $V_{LOGIC} = 1.2V$ to $5.5V$ over recommended operating conditions unless otherwise stated.
Boldface limits apply over the operating temperature range, $-40^{\circ}C$ to $+125^{\circ}C$. (Continued)

SYMBOL	PARAMETER	TEST CONDITIONS	MIN (Note 20)	TYP (Note 8)	MAX (Note 20)	UNITS
VOLTAGE DIVIDER MODE (0V @ RL; V_{CC} @ RH; measured at RW, unloaded)						
INL (Note 13)	Integral Non-linearity, Guaranteed Monotonic	W, U, T options	-0.5	± 0.15	+0.5	LSB (Note 9)
DNL (Note 12)	Differential Non-linearity, Guaranteed Monotonic	W, U, T options	-0.5	± 0.15	+0.5	LSB (Note 9)
FSerror (Note 11)	Full-scale Error	W option	-2.5	-1.5	0	LSB (Note 9)
		U, T option	-1.0	-0.7	0	LSB (Note 9)
ZSerror (Note 10)	Zero-scale Error	W option	0	1.5	2.5	LSB (Note 9)
		U, T option	0	0.7	1.0	LSB (Note 9)
TC _V (Notes 14)	Ratiometric Temperature Coefficient	W option, Wiper Register set to 40 hex		8		ppm/ $^{\circ}C$
		U option, Wiper Register set to 40 hex		4		ppm/ $^{\circ}C$
		T option, Wiper Register set to 40 hex		2.3		ppm/ $^{\circ}C$
	Large Signal Wiper Settling Time	From code 0 to 7F hex		300		ns
f _{cutoff}	-3dB Cutoff Frequency	Wiper at middle point W option		1200		kHz
		Wiper at middle point U option		250		kHz
		Wiper at middle point T option		120		kHz
RHEOSTAT MODE (Measurements between RW and RL pins with RH not connected, or between RW and RH with RL not connected)						
R _{INL} (Note 18)	Integral Non-linearity, Guaranteed Monotonic	W option; $V_{CC} = 2.7V$ to $5.5V$	-1.0	± 0.5	+1.0	MI (Note 15)
		W option; $V_{CC} = 1.7V$		± 3.0		MI (Note 15)
		U, T option; $V_{CC} = 2.7V$ to $5.5V$	-0.5	± 0.15	+0.5	MI (Note 15)
		U, T option; $V_{CC} = 1.7V$		± 1.0		MI (Note 15)
R _{DNL} (Note 17)	Differential Non-linearity, Guaranteed Monotonic	W option; $V_{CC} = 2.7V$ to $5.5V$	-0.5	± 0.15	+0.5	MI (Note 15)
		W option; $V_{CC} = 1.7V$		± 0.4		MI (Note 15)
		U, T option; $V_{CC} = 2.7V$ to $5.5V$	-0.5	± 0.15	+0.5	MI (Note 15)
		U, T option; $V_{CC} = 1.7V$		± 0.4		MI (Note 15)
R _{offset} (Note 16)	Offset, Wiper at 0 Position	W option; $V_{CC} = 2.7V$ to $5.5V$	0	1.8	3.0	MI (Note 15)
		W option; $V_{CC} = 1.7V$		3.0		MI (Note 15)
		U, T option; $V_{CC} = 2.7V$ to $5.5V$	0	0.3	1	MI (Note 15)
		U, T option; $V_{CC} = 1.7V$		0.5		MI (Note 15)

Analog Specifications $V_{CC} = 2.7V$ to $5.5V$, $V_{LOGIC} = 1.2V$ to $5.5V$ over recommended operating conditions unless otherwise stated.
Boldface limits apply over the operating temperature range, $-40^{\circ}C$ to $+125^{\circ}C$. (Continued)

SYMBOL	PARAMETER	TEST CONDITIONS	MIN (Note 20)	TYP (Note 8)	MAX (Note 20)	UNITS
TCR (Note 19)	Resistance Temperature Coefficient	W option; Wiper register set between 19 hex and 7F hex		220		ppm/ $^{\circ}C$
		U option; Wiper register set between 19 hex and 7F hex		100		ppm/ $^{\circ}C$
		T option; Wiper register set between 19 hex and 7F hex		75		ppm/ $^{\circ}C$

Operating Specifications $V_{CC} = 2.7V$ to $5.5V$, $V_{LOGIC} = 1.2V$ to $5.5V$ over recommended operating conditions unless otherwise stated.
Boldface limits apply over the operating temperature range, $-40^{\circ}C$ to $+125^{\circ}C$.

SYMBOL	PARAMETER	TEST CONDITIONS	MIN (Note 20)	TYP (Note 8)	MAX (Note 20)	UNITS
I_{LOGIC}	V_{LOGIC} Supply Current (Write/Read)	$V_{LOGIC} = 5.5V$, $V_{CC} = 5.5V$, $f_{SCL} = 400kHz$ (for I ² C active read and write)			200	μA
		$V_{LOGIC} = 1.2V$, $V_{CC} = 1.7V$, $f_{SCL} = 400kHz$ (for I ² C active read and write)			5	μA
I_{CC}	V_{CC} Supply Current (Write/Read)	$V_{LOGIC} = 5.5V$, $V_{CC} = 5.5V$			18	μA
		$V_{LOGIC} = 1.2V$, $V_{CC} = 1.7V$			10	μA
$I_{LOGIC SB}$	V_{LOGIC} Standby Current	$V_{LOGIC} = V_{CC} = 5.5V$, I ² C interface in standby			1.3	μA
		$V_{LOGIC} = 1.2V$, $V_{CC} = 1.7V$, I ² C interface in standby			0.4	μA
$I_{CC SB}$	V_{CC} Standby Current	$V_{LOGIC} = V_{CC} = 5.5V$, I ² C interface in standby			1.5	μA
		$V_{LOGIC} = 1.2V$, $V_{CC} = 1.7V$, I ² C interface in standby			1	μA
$I_{LOGIC SHDN}$	V_{LOGIC} Shutdown Current	$V_{LOGIC} = V_{CC} = 5.5V$, I ² C interface in standby			1.3	μA
		$V_{LOGIC} = 1.2V$, $V_{CC} = 1.7V$, I ² C interface in standby			0.4	μA
$I_{CC SHDN}$	V_{CC} Shutdown Current	$V_{LOGIC} = V_{CC} = 5.5V$, I ² C interface in standby			1.5	μA
		$V_{LOGIC} = 1.2V$, $V_{CC} = 1.7V$, I ² C interface in standby			1	μA
I_{LkgDig}	Leakage Current, at Pins A0, A1, SDA, SCL	Voltage at pin from GND to V_{LOGIC}	-0.4	<0.1	0.4	μA
t_{DCP}	Wiper Response Time	SCL rising edge of the acknowledge bit after data byte to wiper new position		1.5		μs
$t_{ShdnRec}$	DCP Recall Time from Shutdown Mode	SCL rising edge of the acknowledge bit after ACR data byte to wiper recalled position and RH connection		1.5		μs
V_{CC}, V_{LOGIC} Ramp (Note 21)	V_{CC}, V_{LOGIC} Ramp Rate	Ramp monotonic at any level	0.01		50	V/ms

Serial Interface Specification For SCL, SDA, A0, A1 unless otherwise noted.

SYMBOL	PARAMETER	TEST CONDITIONS	MIN (Note 20)	TYP (Note 8)	MAX (Note 20)	UNITS
V _{IL}	Input LOW Voltage		-0.3		0.3 x V _{LOGIC}	V
V _{IH}	Input HIGH Voltage		0.7 x V _{LOGIC}		V _{LOGIC} + 0.3	V
Hysteresis	SDA and SCL Input Buffer Hysteresis	V _{LOGIC} > 2V	0.05 x V _{LOGIC}			V
		V _{LOGIC} < 2V	0.1 x V _{LOGIC}			
V _{OL}	SDA Output Buffer LOW Voltage	I _{OL} = 3mA, V _{LOGIC} > 2V	0		0.4	V
		I _{OL} = 1.5mA, V _{LOGIC} < 2V			0.2 x V _{LOGIC}	V
C _{pin}	SDA, SCL Pin Capacitance			10		pF
f _{SCL}	SCL Frequency				400	kHz
t _{sp}	Pulse Width Suppression Time at SDA and SCL Inputs	Any pulse narrower than the max spec is suppressed			50	ns
t _{AA}	SCL Falling Edge to SDA Output Data Valid	SCL falling edge crossing 30% of V _{LOGIC} , until SDA exits the 30% to 70% of V _{LOGIC} window			900	ns
t _{BUF}	Time the Bus Must be Free Before the Start of a New Transmission	SDA crossing 70% of V _{LOGIC} during a STOP condition, to SDA crossing 70% of V _{LOGIC} during the following START condition	1300			ns
t _{LOW}	Clock LOW Time	Measured at the 30% of V _{LOGIC} crossing	1300			ns
t _{HIGH}	Clock HIGH Time	Measured at the 70% of V _{LOGIC} crossing	600			ns
t _{SU:STA}	START Condition Set-up Time	SCL rising edge to SDA falling edge; both crossing 70% of V _{LOGIC}	600			ns
t _{HD:STA}	START Condition Hold Time	From SDA falling edge crossing 30% of V _{LOGIC} to SCL falling edge crossing 70% of V _{LOGIC}	600			ns
t _{SU:DAT}	Input Data Set-up Time	From SDA exiting the 30% to 70% of V _{LOGIC} window, to SCL rising edge crossing 30% of V _{LOGIC}	100			ns
t _{HD:DAT}	Input Data Hold Time	From SCL falling edge crossing 70% of V _{CC} to SDA entering the 30% to 70% of V _{LOGIC} window	0			ns
t _{SU:STO}	STOP Condition Set-up Time	From SCL rising edge crossing 70% of V _{LOGIC} , to SDA rising edge crossing 30% of V _{LOGIC}	600			ns
t _{HD:STO}	STOP Condition Hold Time for Read or Write	From SDA rising edge to SCL falling edge; both crossing 70% of V _{LOGIC}	1300			ns
t _{DH}	Output Data Hold Time	From SCL falling edge crossing 30% of V _{LOGIC} , until SDA enters the 30% to 70% of V _{LOGIC} window. I _{OL} = 3mA, V _{LOGIC} > 2V. I _{OL} = 0.5mA, V _{LOGIC} < 2V	0			ns
t _R	SDA and SCL Rise Time	From 30% to 70% of V _{LOGIC}	20 + 0.1 x C _b		250	ns

Serial Interface Specification For SCL, SDA, AO, A1 unless otherwise noted. (Continued)

SYMBOL	PARAMETER	TEST CONDITIONS	MIN (Note 20)	TYP (Note 8)	MAX (Note 20)	UNITS
t_f	SDA and SCL Fall Time	From 70% to 30% of V_{LOGIC}	$20 + 0.1 \times C_b$		250	ns
C_b	Capacitive Loading of SDA or SCL	Total on-chip and off-chip	10		400	pF
$t_{\text{SU:A}}$	A1, A0 Set-up Time	Before START condition	600			ns
$t_{\text{HD:A}}$	A1, A0 Hold Time	After STOP condition	600			ns

NOTES:

8. Typical values are for $T_A = +25^\circ\text{C}$ and 3.3V supply voltages.
9. $\text{LSB} = [V(\text{RW})_{127} - V(\text{RW})_0]/127$. $V(\text{RW})_{127}$ and $V(\text{RW})_0$ are $V(\text{RW})$ for the DCP register set to 7F hex and 00 hex respectively. LSB is the incremental voltage when changing from one tap to an adjacent tap.
10. ZS error = $V(\text{RW})_0/\text{LSB}$.
11. FS error = $[V(\text{RW})_{127} - V_{\text{CC}}]/\text{LSB}$.
12. $\text{DNL} = [V(\text{RW})_i - V(\text{RW})_{i-1}]/\text{LSB} - 1$, for $i = 1$ to 127. i is the DCP register setting.
13. $\text{INL} = [V(\text{RW})_i - i \cdot \text{LSB} - V(\text{RW})_0]/\text{LSB}$ for $i = 1$ to 127.
14.
$$T_{C_V} = \frac{\text{Max}(V(\text{RW})_i) - \text{Min}(V(\text{RW})_i)}{V(\text{RW}_i(+25^\circ\text{C}))} \times \frac{10^6}{+165^\circ\text{C}}$$
 For $i = 16$ to 127 decimal, $T = -40^\circ\text{C}$ to $+125^\circ\text{C}$. $\text{Max}()$ is the maximum value of the wiper voltage and $\text{Min}()$ is the minimum value of the wiper voltage over the temperature range.
15. $\text{MI} = |RW_{127} - RW_0|/127$. MI is a minimum increment. RW_{127} and RW_0 are the measured resistances for the DCP register set to 7F hex and 00 hex respectively.
16. $\text{Roffset} = RW_0/\text{MI}$, when measuring between RW and RL.
 $\text{Roffset} = RW_{127}/\text{MI}$, when measuring between RW and RH.
17. $\text{RDNL} = (RW_i - RW_{i-1})/\text{MI} - 1$, for $i = 8$ to 127.
18. $\text{RINL} = [RW_i - (\text{MI} \cdot i) - RW_0]/\text{MI}$, for $i = 8$ to 127.
19.
$$T_{C_R} = \frac{[\text{Max}(R_i) - \text{Min}(R_i)]}{R_i(+25^\circ\text{C})} \times \frac{10^6}{+165^\circ\text{C}}$$
 For $i = 8$ to 127, $T = -40^\circ\text{C}$ to $+125^\circ\text{C}$. $\text{Max}()$ is the maximum value of the resistance and $\text{Min}()$ is the minimum value of the resistance over the temperature range.
20. Compliance to datasheet limits is assured by one or more methods: production test, characterization and/or design.
21. It is preferable to ramp up both the V_{LOGIC} and the V_{CC} supplies at the same time. If this is not possible, it is recommended to ramp-up the V_{LOGIC} first followed by the V_{CC} .

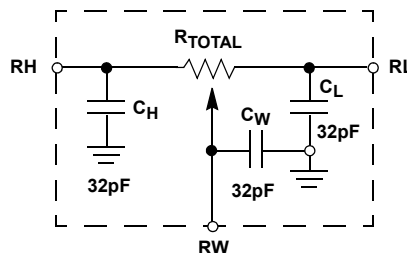
DCP Macro Model

Timing Diagrams

SDA vs SCL Timing

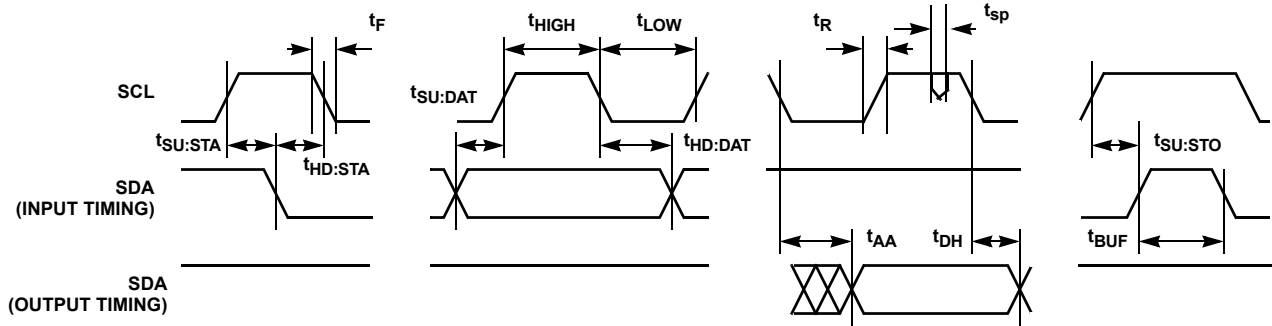

A0 and A1 Pin Timing

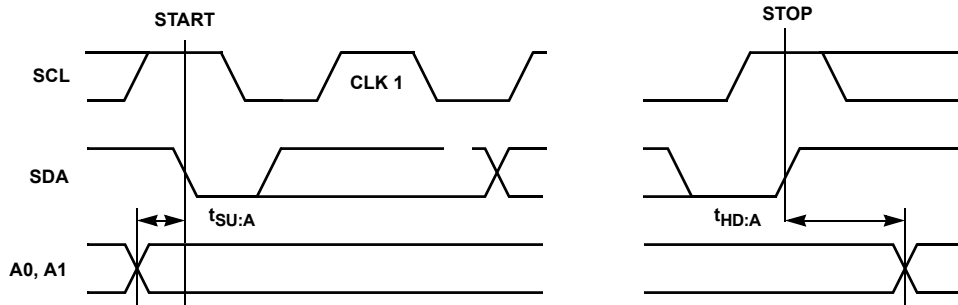

Typical Performance Curves

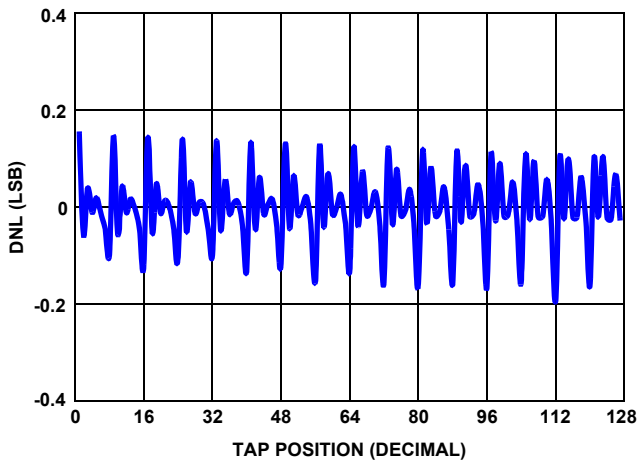

FIGURE 3. 10k DNL vs TAP POSITION, $V_{CC} = 5V$

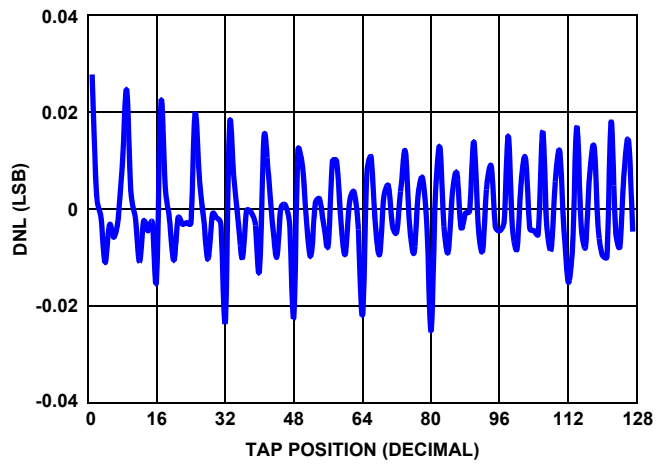

FIGURE 4. 50k DNL vs TAP POSITION, $V_{CC} = 5V$

Typical Performance Curves (Continued)

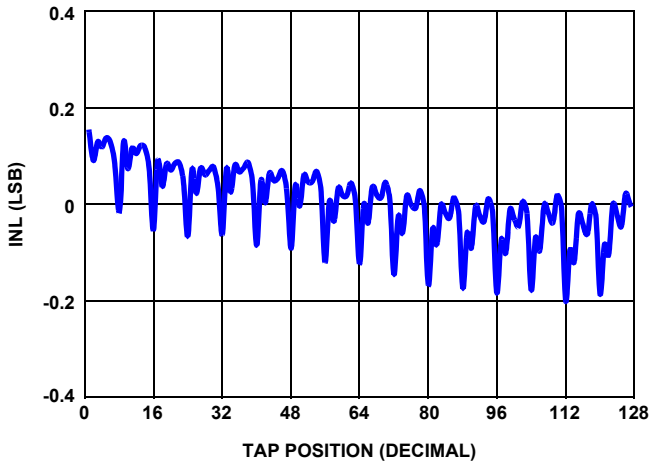

FIGURE 5. 10k INL vs TAP POSITION, $V_{CC} = 5V$

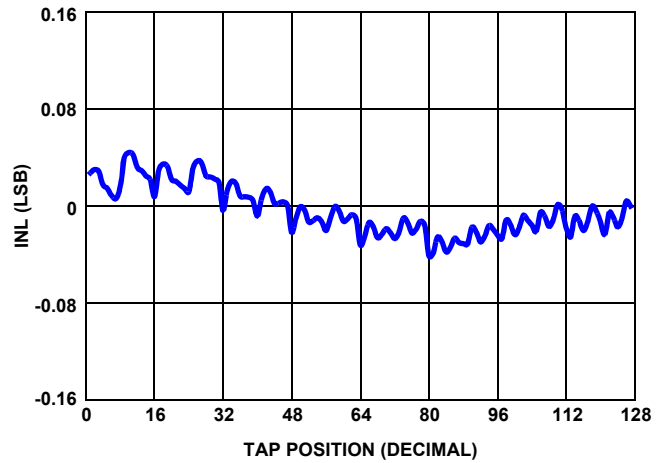

FIGURE 6. 50k INL vs TAP POSITION, $V_{CC} = 5V$

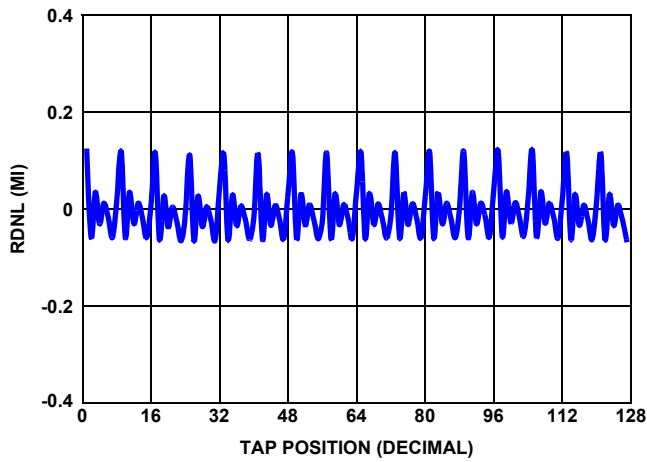

FIGURE 7. 10k RDNL vs TAP POSITION, $V_{CC} = 5V$

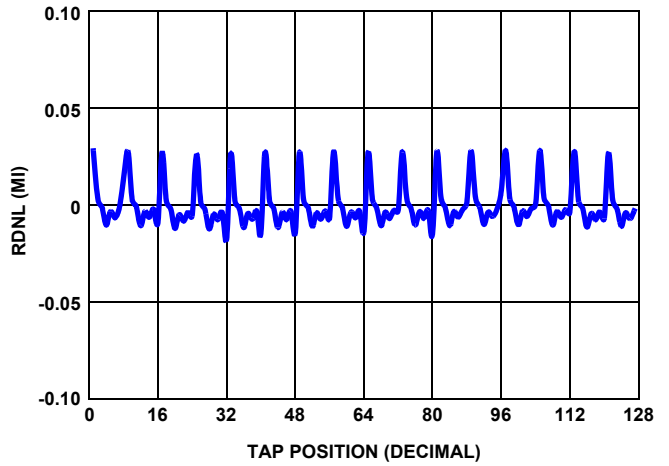

FIGURE 8. 50k RDNL vs TAP POSITION, $V_{CC} = 5V$

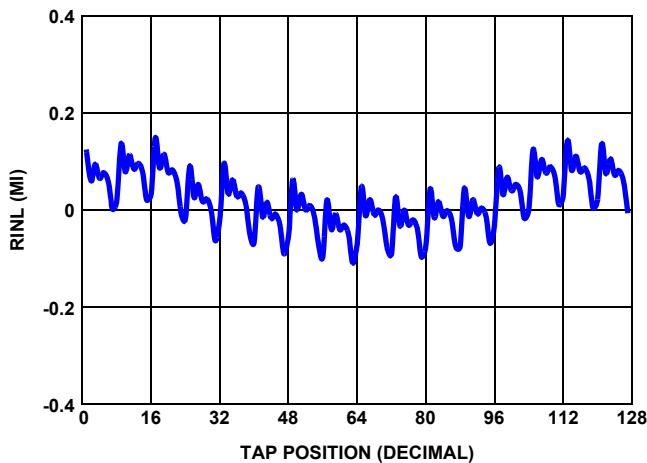

FIGURE 9. 10k RINL vs TAP POSITION, $V_{CC} = 5V$

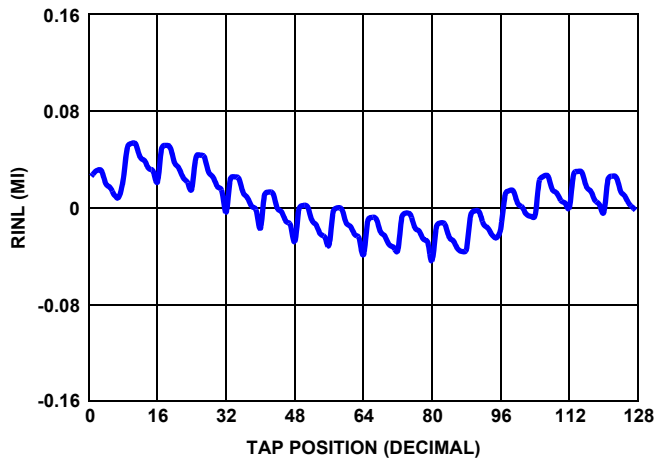

FIGURE 10. 50k RINL vs TAP POSITION, $V_{CC} = 5V$

Typical Performance Curves (Continued)

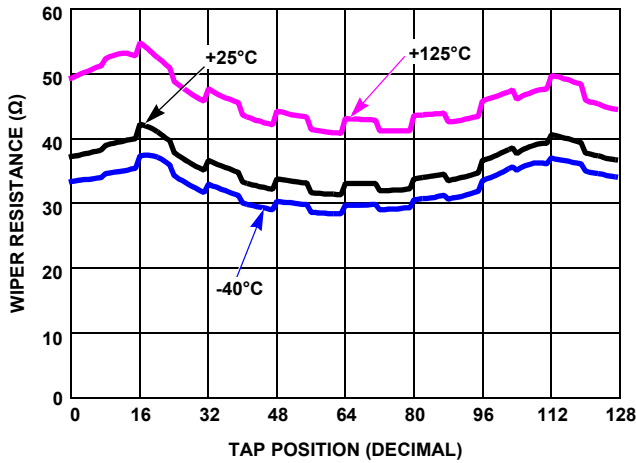

FIGURE 11. 10k WIPER RESISTANCE vs TAP POSITION, $V_{CC} = 5V$

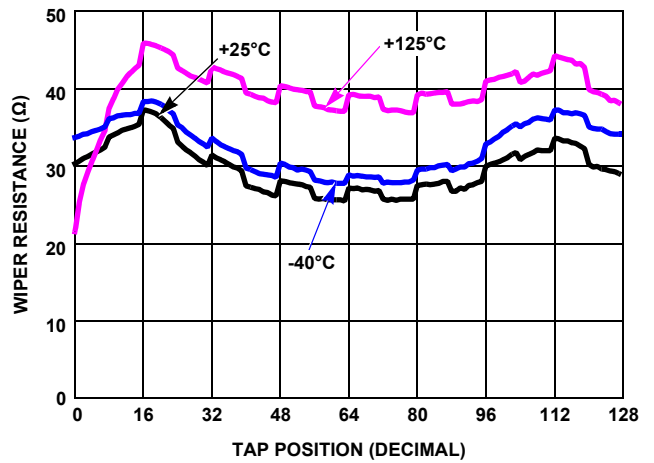

FIGURE 12. 50k WIPER RESISTANCE vs TAP POSITION, $V_{CC} = 5V$

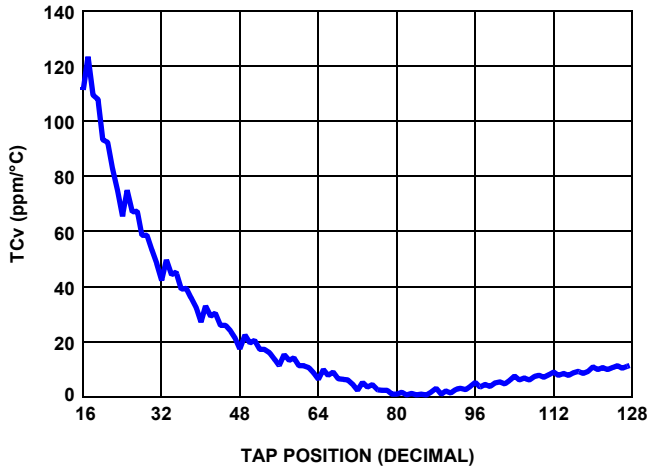

FIGURE 13. 10k TCv vs TAP POSITION

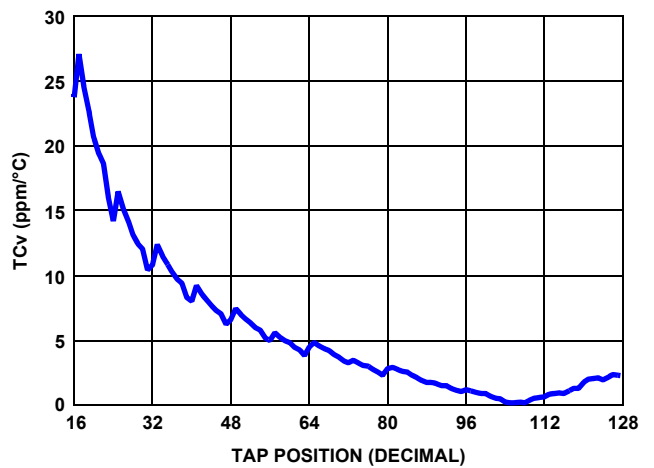

FIGURE 14. 50k TCv vs TAP POSITION

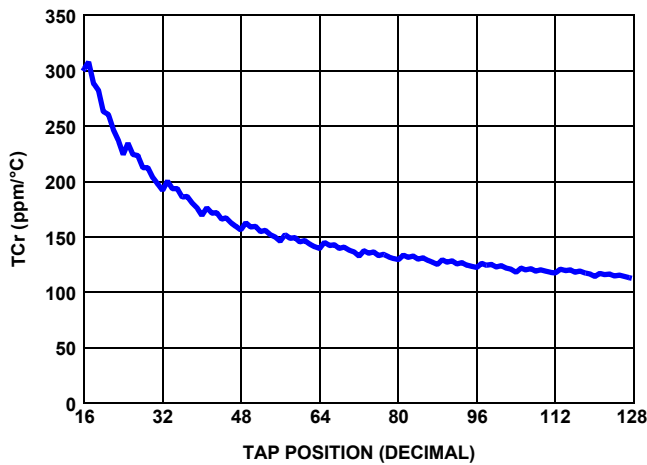

FIGURE 15. 10k TCr vs TAP POSITION

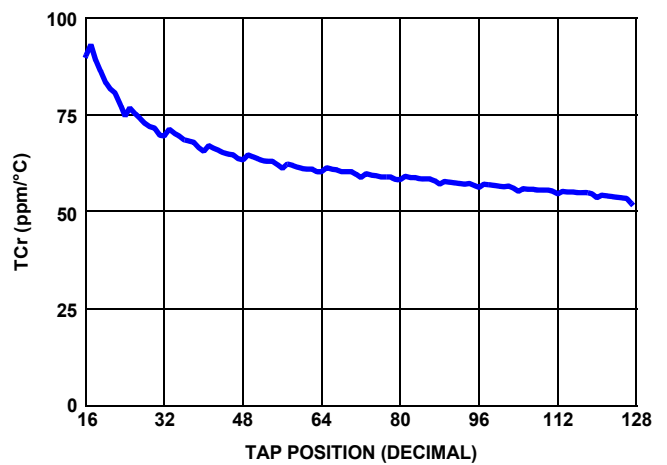

FIGURE 16. 50k TCr vs TAP POSITION

Typical Performance Curves (Continued)

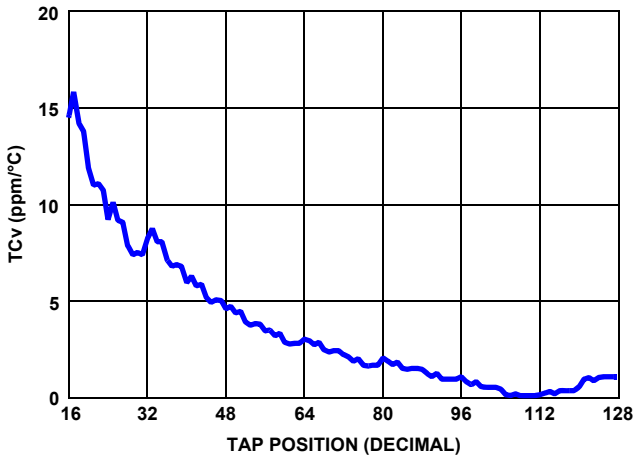

FIGURE 17. 100k TCv vs TAP POSITION

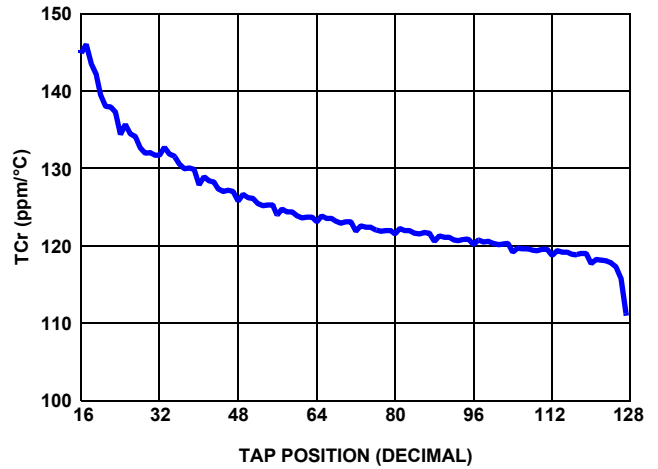

FIGURE 18. 100k TCr vs TAP POSITION

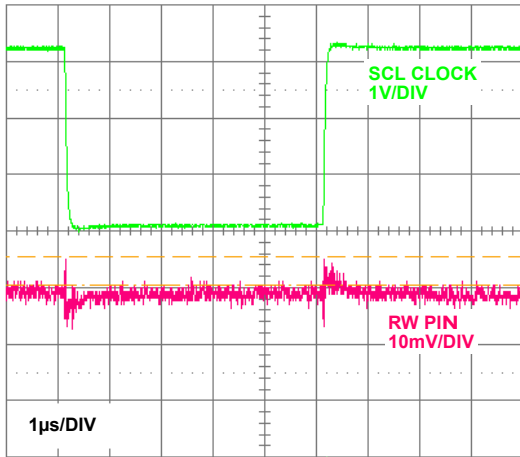

FIGURE 19. WIPER DIGITAL FEED-THROUGH

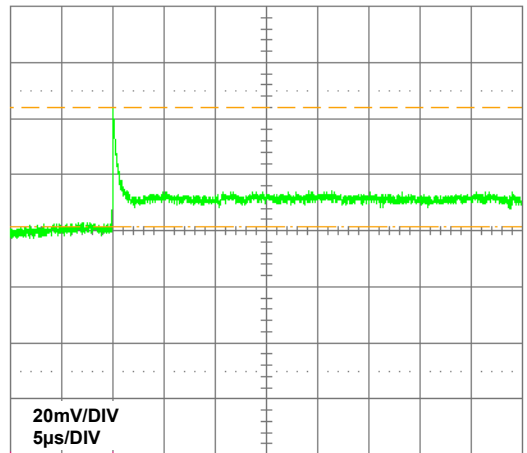

FIGURE 20. WIPER TRANSITION GLITCH

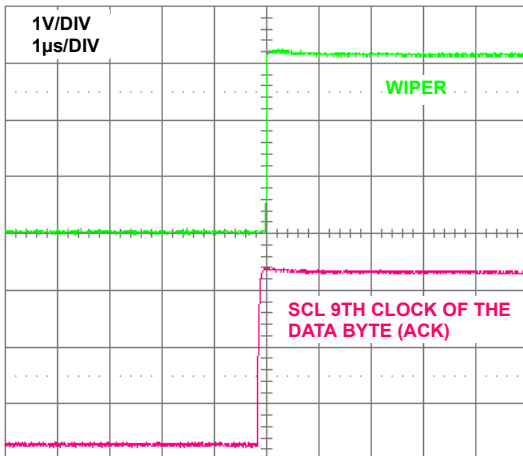

FIGURE 21. WIPER LARGE SIGNAL SETTLING TIME

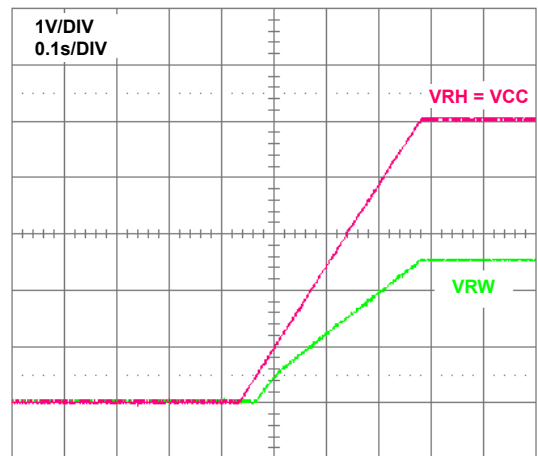

FIGURE 22. POWER-ON START-UP IN VOLTAGE DIVIDER MODE

Typical Performance Curves (Continued)

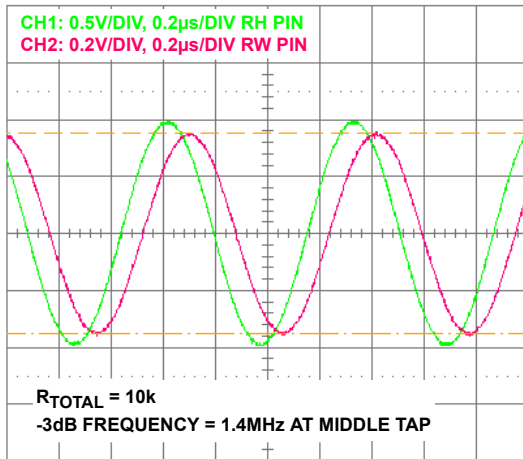

FIGURE 23. 10k -3dB CUT OFF FREQUENCY

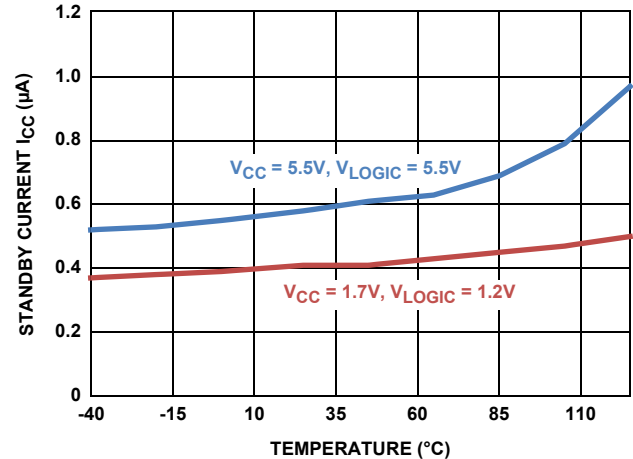

FIGURE 24. STANDBY CURRENT vs TEMPERATURE

Functional Pin Descriptions

Potentiometers Pins

RH AND RL

The high (R_H) and low (R_L) terminals of the ISL23318 are equivalent to the fixed terminals of a mechanical potentiometer. R_H and R_L are referenced to the relative position of the wiper and not the voltage potential on the terminals. With WR set to 127 decimal, the wiper will be closest to R_H , and with the WR set to 0, the wiper is closest to R_L .

RW

RW is the wiper terminal, and it is equivalent to the movable terminal of a mechanical potentiometer. The position of the wiper within the array is determined by the WR register.

Bus Interface Pins

SERIAL DATA INPUT/OUTPUT (SDA)

The SDA is a bidirectional serial data input/output pin for I^2C interface. It receives device address, wiper address and data from an I^2C external master device at the rising edge of the serial clock SCL, and it shifts out data after each falling edge of the serial clock.

SDA requires an external pull-up resistor, since it is an open drain input/output.

SERIAL CLOCK (SCL)

This input is the serial clock of the I^2C serial interface. SCL requires an external pull-up resistor, since a master is an open drain output.

DEVICE ADDRESS (A1, A0)

The address inputs are used to set the least significant 2 bits of the 7-bit I^2C interface slave address. A match in the slave address serial data stream must match with the Address input pins in order to initiate communication with the ISL23318. A maximum of four ISL23318 devices may occupy the I^2C serial bus (see Table 3).

V_{LOGIC}

This is an input pin that supplies internal level translator for serial bus operation from 1.2V to 5.5V.

Principles of Operation

The ISL23318 is an integrated circuit incorporating one DCP with its associated registers and an I^2C serial interface providing direct communication between a host and the potentiometer. The resistor array is comprised of individual resistors connected in series. At either end of the array and between each resistor is an electronic switch that transfers the potential at that point to the wiper.

The electronic switches on the device operate in a “make-before-break” mode when the wiper changes tap positions.

Voltage at any DCP pins, R_H , R_L or R_W , should not exceed V_{CC} level at any conditions during power-up and normal operation.

The V_{LOGIC} pin needs to be connected to the I^2C bus supply which allows reliable communication with the wide range of microcontrollers and independent of the V_{CC} level. This is extremely important in systems where the master supply has lower levels than DCP analog supply.

DCP Description

The DCP is implemented with a combination of resistor elements and CMOS switches. The physical ends of each DCP are equivalent to the fixed terminals of a mechanical potentiometer (R_H and R_L pins). The RW pin of the DCP is connected to intermediate nodes, and is equivalent to the wiper terminal of a mechanical potentiometer. The position of the wiper terminal within the DCP is controlled by a 7-bit volatile Wiper Register (WR). When the WR of a DCP contains all zeroes (WR[7:0] = 00h), its wiper terminal (RW) is closest to its “Low” terminal (R_L). When the WR register of a DCP contains all ones (WR[7:0] = 7Fh), its wiper terminal (RW) is closest to its “High” terminal (R_H). As the value of the WR increases from all zeroes (0) to 0111 1111b (127 decimal), the wiper moves

monotonically from the position closest to RL to the position closest to RH. At the same time, the resistance between RW and RL increases monotonically, while the resistance between RH and RW decreases monotonically.

While the ISL23318 is being powered up, the WR is reset to 40h (64 decimal), which locates RW roughly at the center between RL and RH.

The WR can be read or written to directly using the I²C serial interface as described in the following sections.

Memory Description

The ISL23318 contains two volatile 8-bit registers: Wiper Register (WR) and Access Control Register (ACR). The memory map of ISL23318 is shown in Table 1. The Wiper Register (WR) at address 0 contains current wiper position. The Access Control Register (ACR) at address 10h contains information and control bits described in Table 2.

TABLE 1. MEMORY MAP

ADDRESS (hex)	VOLATILE REGISTER NAME	DEFAULT SETTING (hex)
10	ACR	40
0	WR	40

TABLE 2. ACCESS CONTROL REGISTER (ACR)

BIT #	7	6	5	4	3	2	1	0
NAME/VALUE	0	SHDN	0	0	0	0	0	0

Shutdown Function

The SHDN bit (ACR[6]) disables or enables shutdown mode for all DCP channels simultaneously. When this bit is 0, i.e., DCP is forced to end-to-end open circuit and RW is connected to RL through a 2kΩ serial resistor as shown in Figure 25. Default value of the SHDN bit is 1.

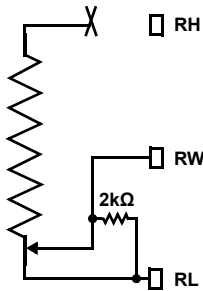

FIGURE 25. DCP CONNECTION IN SHUTDOWN MODE

In the shutdown mode, the RW terminal is shorted to the RL terminal with around 2kΩ resistance as shown in Figure 25. When the device enters shutdown, all current DCP WR settings are maintained. When the device exits shutdown, the wipers will return to the previous WR settings after a short settling time (see Figure 26).

In shutdown mode, if there is a glitch on the power supply which causes it to drop below 1.3V for more than 0.2μs to 0.4μs, the wipers will be RESET to their mid position. This is done to avoid an undefined state at the wiper outputs.

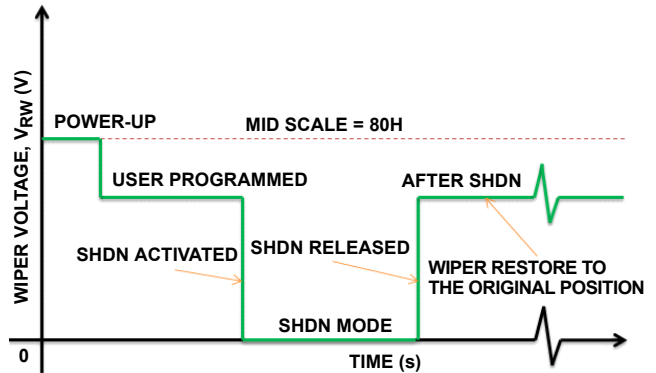

FIGURE 26. SHUTDOWN MODE WIPER RESPONSE

I²C Serial Interface

The ISL23318 supports an I²C bidirectional bus oriented protocol. The protocol defines any device that sends data onto the bus as a transmitter and the receiving device as the receiver. The device controlling the transfer is a master and the device being controlled is the slave. The master always initiates data transfers and provides the clock for both transmit and receive operations. Therefore, the ISL23318 operates as a slave device in all applications.

All communication over the I²C interface is conducted by sending the MSB of each byte of data first.

Protocol Conventions

Data states on the SDA line must change only during SCL LOW periods. SDA state changes during SCL HIGH are reserved for indicating START and STOP conditions (see Figure 27). On power-up of the ISL23318, the SDA pin is in the input mode.

All I²C interface operations must begin with a START condition, which is a HIGH-to-LOW transition of SDA while SCL is HIGH. The ISL23318 continuously monitors the SDA and SCL lines for the START condition and does not respond to any command until this condition is met (see Figure 27). A START condition is ignored during the power-up of the device.

All I²C interface operations must be terminated by a STOP condition, which is a LOW to HIGH transition of SDA while SCL is HIGH (see Figure 27). A STOP condition at the end of a read operation or at the end of a write operation places the device in its standby mode.

An ACK (Acknowledge) is a software convention used to indicate a successful data transfer. The transmitting device, either master or slave, releases the SDA bus after transmitting eight bits. During the ninth clock cycle, the receiver pulls the SDA line LOW to acknowledge the reception of the eight bits of data (see Figure 28).

The ISL23318 responds with an ACK after recognition of a START condition followed by a valid Identification Byte, and once again

after successful receipt of an Address Byte. The ISL23318 also responds with an ACK after receiving a Data Byte of a write operation. The master must respond with an ACK after receiving a Data Byte of a read operation.

A valid Identification Byte contains 10100 as the five MSBs, and the following two bits matching the logic values present at pins A1 and A0. The LSB is the Read/Write bit. Its value is "1" for a Read operation and "0" for a Write operation (see Table 3).

TABLE 3. IDENTIFICATION BYTE FORMAT
LOGIC VALUES AT PINS A1 AND A0, RESPECTIVELY

1	0	1	0	0	A1	A0	R/W
(MSB)					(LSB)		

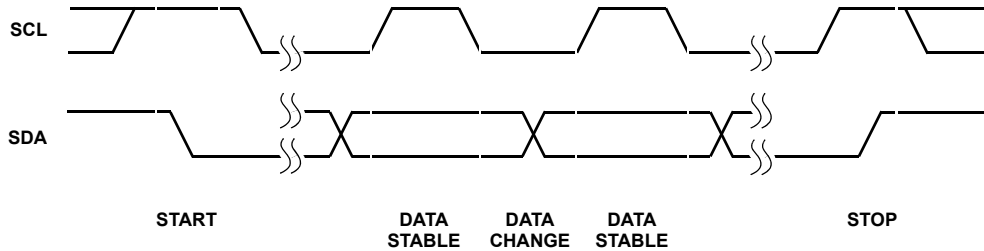

FIGURE 27. VALID DATA CHANGES, START AND STOP CONDITIONS

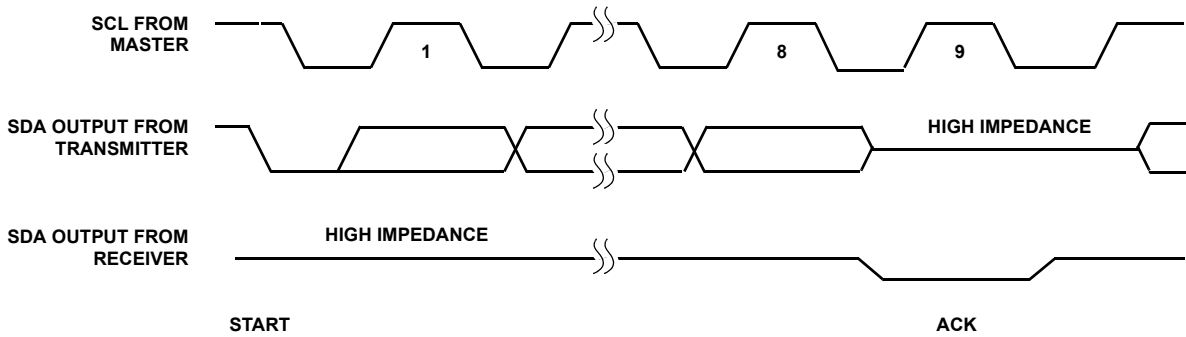

FIGURE 28. ACKNOWLEDGE RESPONSE FROM RECEIVER

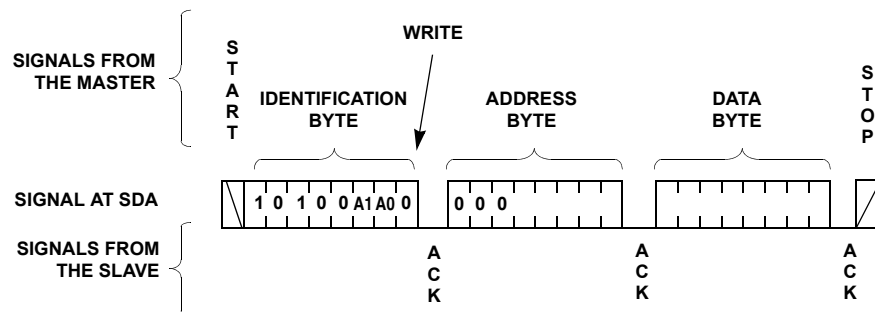

FIGURE 29. BYTE WRITE SEQUENCE

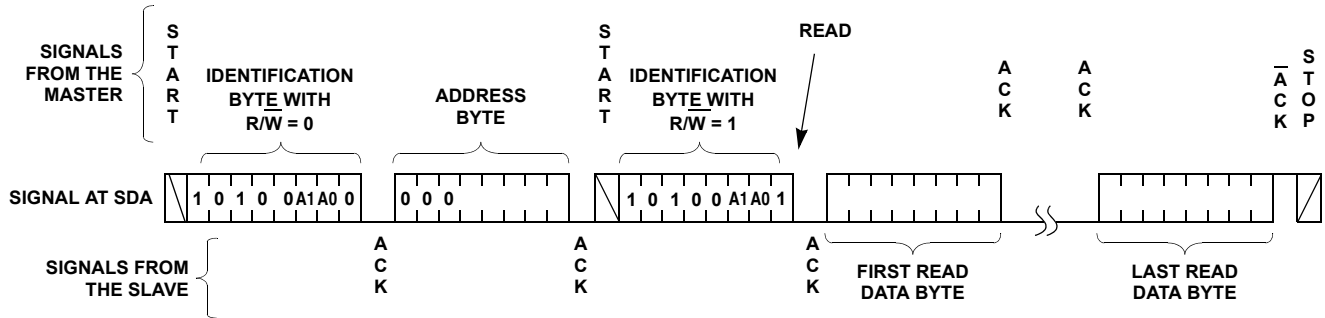

FIGURE 30. READ SEQUENCE

Write Operation

A Write operation requires a START condition, followed by a valid Identification Byte, a valid Address Byte, a Data Byte, and a STOP condition. After each of the three bytes, the ISL23318 responds with an ACK. The data is transferred from I²C block to the corresponding register at the 9th clock of the data byte and device enters its standby state (see Figures 28 and 29).

Read Operation

A Read operation consists of a three byte instruction followed by one or more Data Bytes (see Figure 30). The master initiates the operation issuing the following sequence: a START, the Identification byte with the R/ \bar{W} bit set to "0", an Address Byte, a second START, and a second Identification byte with the R/ \bar{W} bit set to "1". After each of the three bytes, the ISL23318 responds with an ACK; then the ISL23318 transmits Data Byte. The master terminates the read operation issuing a NACK (ACK) and a STOP condition following the last bit of the last Data Byte (see Figure 30).

Applications Information

V_{LOGIC} Requirements

It is recommended to keep V_{LOGIC} powered all the time during normal operation. In a case where turning V_{LOGIC} OFF is necessary, it is recommended to ground the V_{LOGIC} pin of the ISL23318. Grounding the V_{LOGIC} pin or both V_{LOGIC} and V_{CC} does not affect other devices on the same bus. It is good practice to put a 1 μ F cap in parallel to 0.1 μ F as close to the V_{LOGIC} pin as possible.

V_{CC} Requirements and Placement

It is recommended to put a 1 μ F capacitor in parallel with 0.1 μ F decoupling capacitor close to the V_{CC} pin.

Wiper Transition

When stepping up through each tap in voltage divider mode, some tap transition points can result in noticeable voltage transients, or overshoot/undershoot, resulting from the sudden transition from a very low impedance "make" to a much higher impedance "break" within a short period of time (<1 μ s). There are several code transitions such as 0Fh to 10h, 1Fh to 20h, ..., 7Eh to 7Fh, which have higher transient glitch. Note that all switching transients will settle well within the settling time as stated in the datasheet. A small capacitor can be added externally to reduce the amplitude of these voltage transients. However, that will also reduce the useful bandwidth of the circuit, thus may not be a good solution for some applications. It may be a good idea, in that case, to use fast amplifiers in a signal chain for fast recovery.

Revision History

The revision history provided is for informational purposes only and is believed to be accurate, but not warranted. Please go to web to make sure you have the latest Rev.

DATE	REVISION	CHANGE
7/26/11	FN7887.0	Initial Release

Products

Intersil Corporation is a leader in the design and manufacture of high-performance analog semiconductors. The Company's products address some of the industry's fastest growing markets, such as, flat panel displays, cell phones, handheld products, and notebooks. Intersil's product families address power management and analog signal processing functions. Go to www.intersil.com/products for a complete list of Intersil product families.

*For a complete listing of Applications, Related Documentation and Related Parts, please see the respective device information page on intersil.com: [ISL23318](http://www.intersil.com/ISL23318)

To report errors or suggestions for this datasheet, please go to www.intersil.com/askourstaff

FITs are available from our website at <http://rel.intersil.com/reports/search.php>

© Copyright Intersil Americas LLC 2011. All Rights Reserved.

All trademarks and registered trademarks are the property of their respective owners.

For additional products, see www.intersil.com/en/products.html

Intersil products are manufactured, assembled and tested utilizing ISO9001 quality systems as noted in the quality certifications found at www.intersil.com/en/support/qualandreliability.html

Intersil products are sold by description only. Intersil may modify the circuit design and/or specifications of products at any time without notice, provided that such modification does not, in Intersil's sole judgment, affect the form, fit or function of the product. Accordingly, the reader is cautioned to verify that datasheets are current before placing orders. Information furnished by Intersil is believed to be accurate and reliable. However, no responsibility is assumed by Intersil or its subsidiaries for its use; nor for any infringements of patents or other rights of third parties which may result from its use. No license is granted by implication or otherwise under any patent or patent rights of Intersil or its subsidiaries.

For information regarding Intersil Corporation and its products, see www.intersil.com

Mini Small Outline Plastic Packages (MSOP)

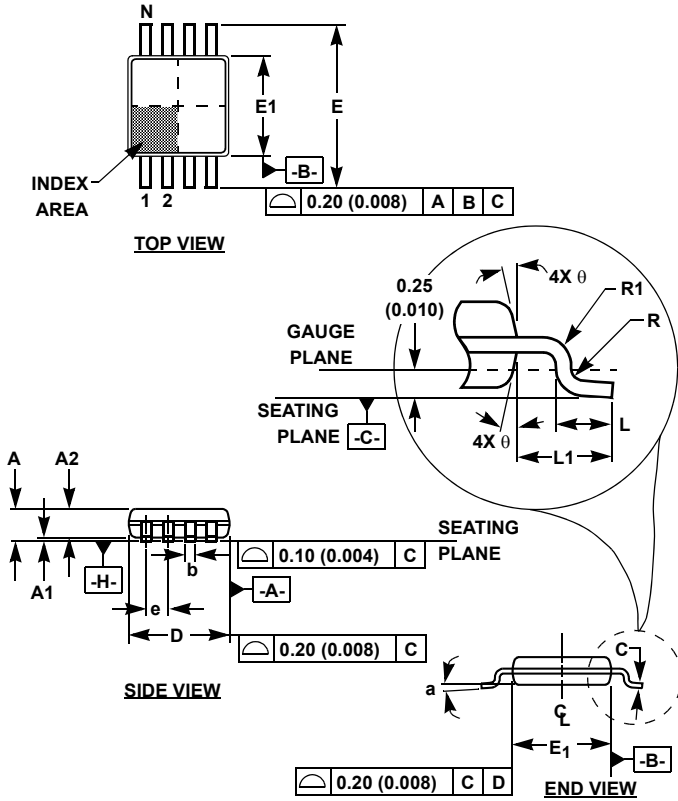

M10.118 (JEDEC MO-187BA)
10 LEAD MINI SMALL OUTLINE PLASTIC PACKAGE

SYMBOL	INCHES		MILLIMETERS		NOTES
	MIN	MAX	MIN	MAX	
A	0.037	0.043	0.94	1.10	-
A1	0.002	0.006	0.05	0.15	-
A2	0.030	0.037	0.75	0.95	-
b	0.007	0.011	0.18	0.27	9
c	0.004	0.008	0.09	0.20	-
D	0.116	0.120	2.95	3.05	3
E1	0.116	0.120	2.95	3.05	4
e	0.020 BSC		0.50 BSC		-
E	0.187	0.199	4.75	5.05	-
L	0.016	0.028	0.40	0.70	6
L1	0.037 REF		0.95 REF		-
N	10		10		7
R	0.003	-	0.07	-	-
R1	0.003	-	0.07	-	-
θ	5°	15°	5°	15°	-
α	0°	6°	0°	6°	-

Rev. 0 12/02

NOTES:

1. These package dimensions are within allowable dimensions of JEDEC MO-187BA.
2. Dimensioning and tolerancing per ANSI Y14.5M-1994.
3. Dimension "D" does not include mold flash, protrusions or gate burrs and are measured at Datum Plane. Mold flash, protrusion and gate burrs shall not exceed 0.15mm (0.006 inch) per side.
4. Dimension "E1" does not include interlead flash or protrusions and are measured at Datum Plane. [-H-] Interlead flash and protrusions shall not exceed 0.15mm (0.006 inch) per side.
5. Formed leads shall be planar with respect to one another within 0.10mm (.004) at seating Plane.
6. "L" is the length of terminal for soldering to a substrate.
7. "N" is the number of terminal positions.
8. Terminal numbers are shown for reference only.
9. Dimension "b" does not include dambar protrusion. Allowable dambar protrusion shall be 0.08mm (0.003 inch) total in excess of "b" dimension at maximum material condition. Minimum space between protrusion and adjacent lead is 0.07mm (0.0027 inch).
10. Datums [-A-] and [-B-] to be determined at Datum plane [-H-].
11. Controlling dimension: MILLIMETER. Converted inch dimensions are for reference only

Package Outline Drawing

L10.2.1x1.6A

10 LEAD ULTRA THIN QUAD FLAT NO-LEAD PLASTIC PACKAGE

Rev 5, 3/10

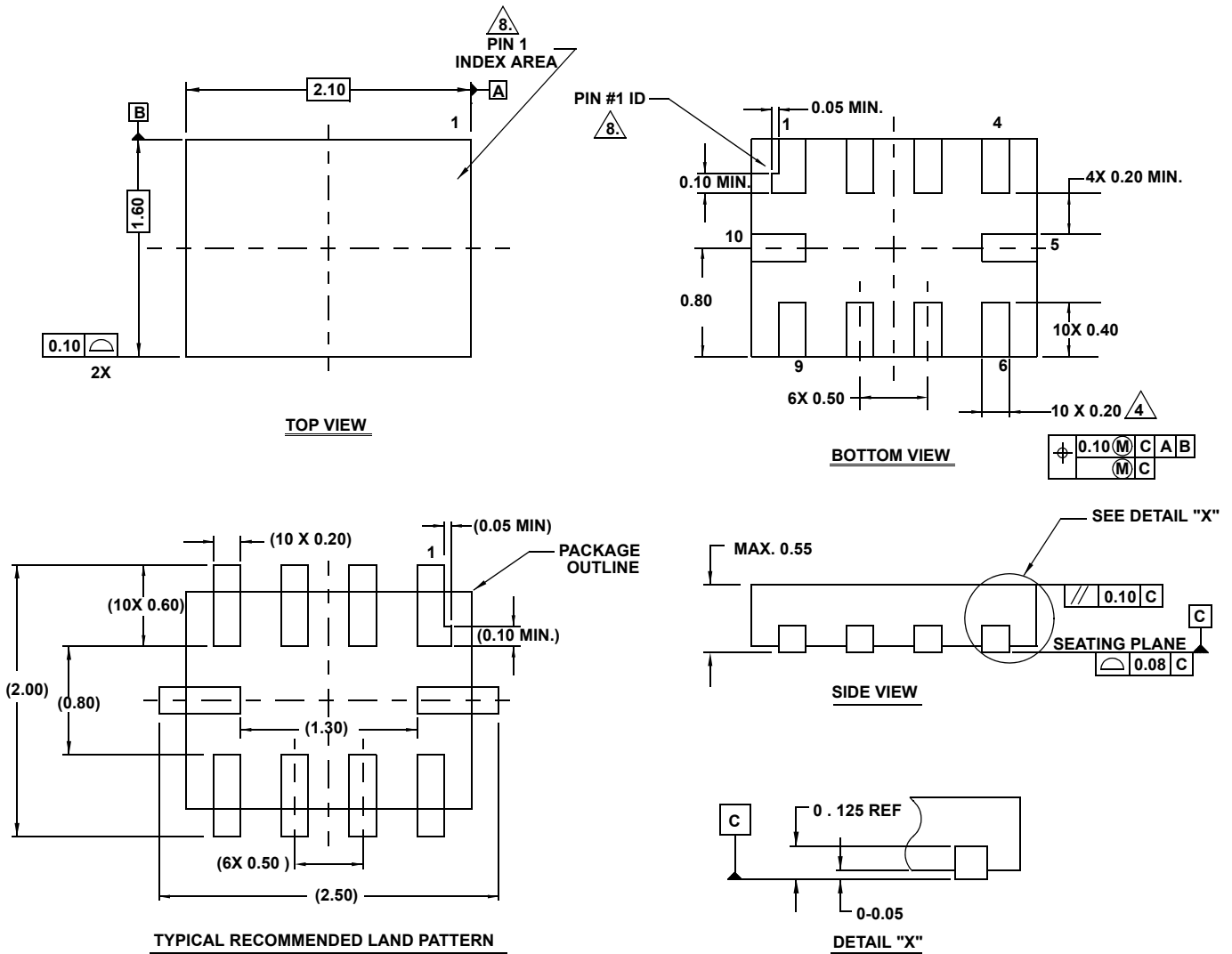

NOTES:

1. Dimensioning and tolerancing conform to ASME Y14.5M-1994.
2. All Dimensions are in millimeters. Angles are in degrees. Dimensions in () for Reference Only.
3. Unless otherwise specified, tolerance : Decimal ± 0.05
4. Lead width dimension applies to the metallized terminal and is measured between 0.15mm and 0.30mm from the terminal tip.
5. Maximum package warpage is 0.05mm.
6. Maximum allowable burrs is 0.076mm in all directions.
7. Same as JEDEC MO-255UABD except:
No lead-pull-back, MIN. Package thickness = 0.45 not 0.50mm
Lead Length dim. = 0.45mm max. not 0.42mm.
8. The configuration of the pin #1 identifier is optional, but must be located within the zone indicated. The pin #1 identifier may be either a mold or mark feature.