

ISL23345

Quad, 256 Tap, Low Voltage Digitally Controlled Potentiometer (XDCP™)

FN7872  
Rev 0.00  
June 21, 2011

The ISL23345 is a volatile, low voltage, low noise, low power, 256 tap, quad digitally controlled potentiometer (DCP) with an I<sup>2</sup>C Bus™ interface. It integrates four DCP cores, wiper switches and control logic on a monolithic CMOS integrated circuit.

Each digitally controlled potentiometer is implemented with a combination of resistor elements and CMOS switches. The position of the wipers are controlled by the user through the I<sup>2</sup>C bus interface. Each potentiometer has an associated volatile Wiper Register (WRI, i = 0, 1, 2, 3) that can be directly written to and read by the user. The contents of the WRI controls the position of the wiper. When powered on, the wiper of each DCP will always commence at mid-scale (128 tap position).

The low voltage, low power consumption, and small package of the ISL23345 make it an ideal choice for use in battery operated equipment. In addition, the ISL23345 has a V<sub>LOGIC</sub> pin allowing down to 1.2V bus operation, independent from the V<sub>CC</sub> value. This allows for low logic levels to be connected directly to the ISL23345 without passing through a voltage level shifter.

The DCP can be used as a three-terminal potentiometer or as a two-terminal variable resistor in a wide variety of applications including control, parameter adjustments, and signal processing.

**Applications**

- Power supply margining
- Trimming sensor circuits
- Gain adjustment in battery powered instruments
- RF power amplifier bias compensation

**Features**

- Four potentiometers per package
- 256 resistor taps
- 10kΩ, 50kΩ or 100kΩ total resistance
- I<sup>2</sup>C serial interface
  - No additional level translator for low bus supply
  - Three address pins allow up to eight devices per bus
- Maximum supply current without serial bus activity (standby)
  - 5μA @ V<sub>CC</sub> and V<sub>LOGIC</sub> = 5V
  - 2μA @ V<sub>CC</sub> and V<sub>LOGIC</sub> = 1.7V
- Shutdown Mode
  - Forces the DCP into an end-to-end open circuit and RWi is connected to RLi internally
  - Reduces power consumption by disconnecting the DCP resistor from the circuit
- Power supply
  - V<sub>CC</sub> = 1.7V to 5.5V analog power supply
  - V<sub>LOGIC</sub> = 1.2V to 5.5V I<sup>2</sup>C bus/logic power supply
- Wiper resistance: 70Ω typical @ V<sub>CC</sub> = 3.3V
- Power-on preset to mid-scale (128 tap position)
- Extended industrial temperature range: -40°C to +125°C
- 20 Ld TSSOP or 20 QFN packages
- Pb-free (RoHS compliant)

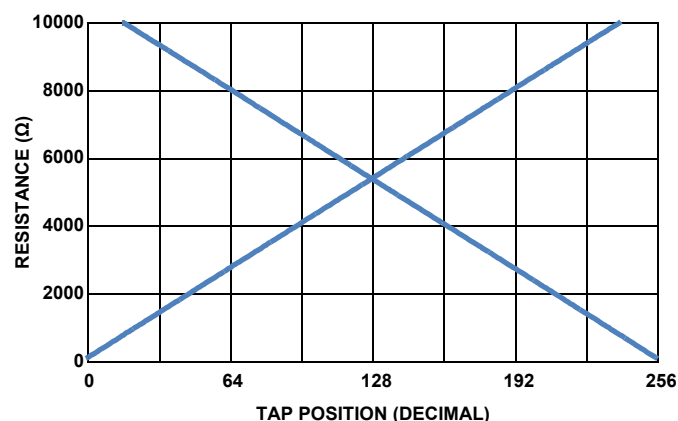

FIGURE 1. FORWARD AND BACKWARD RESISTANCE vs TAP POSITION, 10kΩ DCP

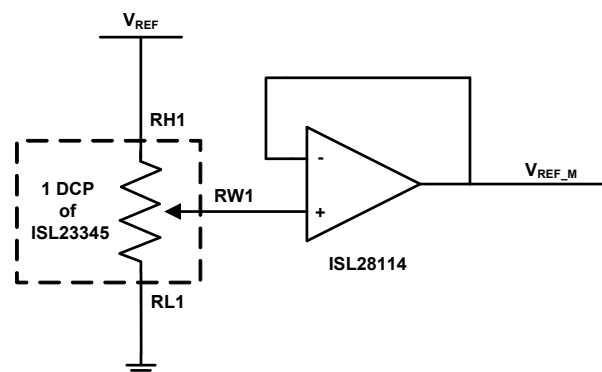
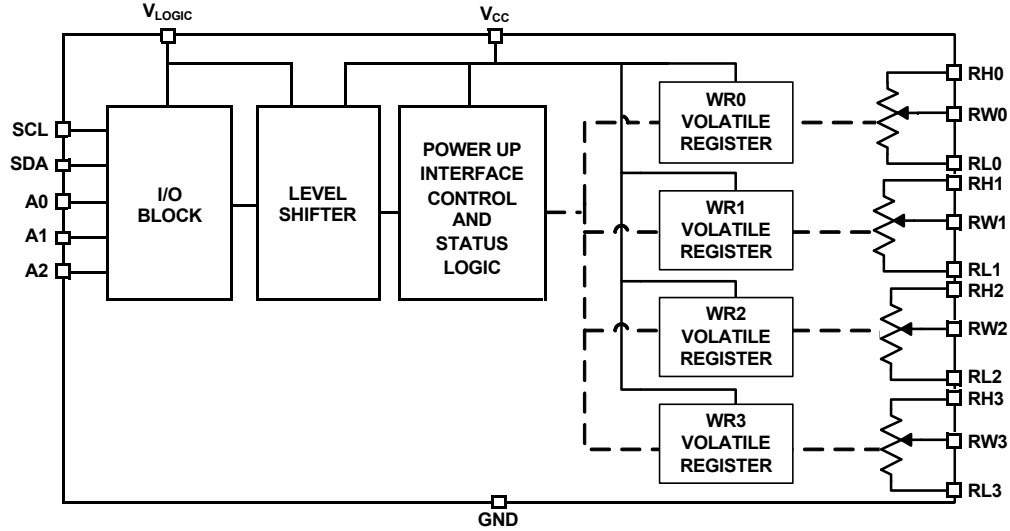
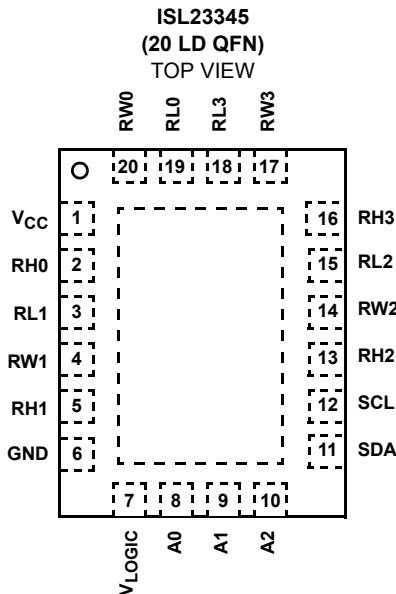
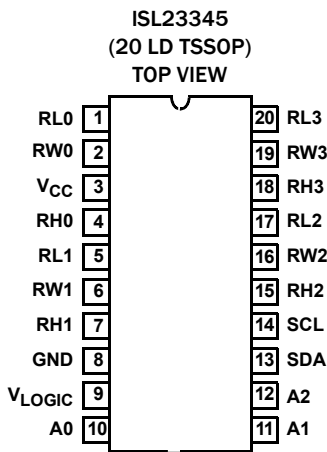

FIGURE 2. V<sub>REF</sub> ADJUSTMENT

# Block Diagram



## Pin Configurations



## Pin Descriptions

TSSOP	QFN	SYMBOL	DESCRIPTION
1	19	RL0	DCP0 "low" terminal
2	20	RW0	DCP0 wiper terminal
3	1	V <sub>CC</sub>	Analog power supply. Range 1.7V to 5.5V
4	2	RH0	DCP0 "high" terminal
5	3	RL1	DCP1 "low" terminal
6	4	RW1	DCP1 wiper terminal
7	5	RH1	DCP1 "high" terminal
8	6	GND	Ground pin
9	7	V <sub>LOGIC</sub>	I <sup>2</sup> C bus /logic supply. Range 1.2V to 5.5V
10	8	A0	Logic Pin - Hardwire slave address pin for I <sup>2</sup> C serial bus. Range: V <sub>LOGIC</sub> or GND
11	9	A1	Logic Pin - Hardwire slave address pin for I <sup>2</sup> C serial bus. Range: V <sub>LOGIC</sub> or GND
12	10	A2	Logic Pin - Hardwire slave address pin for I <sup>2</sup> C serial bus. Range: V <sub>LOGIC</sub> or GND
13	11	SDA	Logic Pin - Serial bus data input/open drain output
14	12	SCL	Logic Pin - Serial bus clock input
15	13	RH2	DCP2 "high" terminal
16	14	RW2	DCP2 wiper terminal
17	15	RL2	DCP2 "low" terminal
18	16	RH3	DCP3 "high" terminal
19	17	RW3	DCP3 wiper terminal
20	18	RL3	DCP3 "low" terminal

## Ordering Information

PART NUMBER (Notes 1, 2, 3)	PART MARKING	RESISTANCE OPTION (k $\Omega$ )	TEMP RANGE (°C)	PACKAGE (Pb-free)	PKG. DWG. #
ISL23345TFVZ	23345 TFVZ	100	-40 to +125	20 Ld TSSOP	MDP0044
ISL23345UFVZ	23345 UFVZ	50	-40 to +125	20 Ld TSSOP	MDP0044
ISL23345WVZ	23325 WVZ	10	-40 to +125	20 Ld TSSOP	MDP0044
ISL23345TFRZ	345T	100	-40 to +125	20 Ld 3x4 QFN	L20.3x4
ISL23345UFRZ	345U	50	-40 to +125	20 Ld 3x4 QFN	L20.3x4
ISL23345WFRZ	345W	10	-40 to +125	20 Ld 3x4 QFN	L20.3x4

### NOTES:

1. Add "-TK" suffix for 1k unit or "-T7A" suffix for 250 unit Tape and Reel options. Please refer to [TB347](#) for details on reel specifications.
2. These Intersil Pb-free plastic packaged products employ special Pb-free material sets, molding compounds/die attach materials, and 100% matte tin plate plus anneal (e3 termination finish, which is RoHS compliant and compatible with both SnPb and Pb-free soldering operations). Intersil Pb-free products are MSL classified at Pb-free peak reflow temperatures that meet or exceed the Pb-free requirements of IPC/JEDEC J STD-020.
3. For Moisture Sensitivity Level (MSL), please see device information page for [ISL23345](#). For more information on MSL please see techbrief [TB363](#).

## Absolute Maximum Ratings

Supply Voltage Range	
$V_{CC}$	-0.3V to 6.0V
$V_{LOGIC}$	-0.3V to 6.0V
Voltage on Any DCP Terminal Pin	-0.3V to 6.0V
Voltage on Any Digital Pins	-0.3V to 6.0V
Wiper Current $I_W$ (10s)	$\pm 6$ mA
ESD Rating	
Human Body Model (Tested per JESD22-A114E)	6kV
CDM Model (Tested per JESD22-A114E)	1kV
Machine Model (Tested per JESD22-A115-A)	300V
Latch Up (Tested per JESD-78B; Class 2, Level A)	100mA @ +125°C

## Thermal Information

Thermal Resistance (Typical)	$\theta_{JA}$ (°C/W)	$\theta_{JC}$ (°C/W)
20 Ld TSSOP Package (Notes 4, 6)	85	33
20 Ld QFN Package (Notes 5, 7)	40	4
Maximum Junction Temperature (Plastic Package)	+150°C	
Storage Temperature Range	-65°C to +150°C	
Pb-Free Reflow Profile	see link below <a href="http://www.intersil.com/pbfree/Pb-FreeReflow.asp">http://www.intersil.com/pbfree/Pb-FreeReflow.asp</a>	

## Recommended Operating Conditions

Temperature	-40°C to +125°C
$V_{CC}$ Supply Voltage	1.7V to 5.5V
$V_{LOGIC}$ Supply Voltage	1.2V to 5.5V
DCP Terminal Voltage	.0 to $V_{CC}$
Max Wiper Current	$\pm 3$ mA

**CAUTION:** Do not operate at or near the maximum ratings listed for extended periods of time. Exposure to such conditions may adversely impact product reliability and result in failures not covered by warranty.

### NOTES:

- $\theta_{JA}$  is measured with the component mounted on a high effective thermal conductivity test board in free air. See Tech Brief [TB379](#) for details.
- $\theta_{JA}$  is measured in free air with the component mounted on a high effective thermal conductivity test board with "direct attach" features. See Tech Brief [TB379](#).
- For  $\theta_{JC}$ , the "case temp" location is taken at the package top center.
- For  $\theta_{JC}$ , the "case temp" location is the center of the exposed metal pad on the package underside.

## Analog Specifications

$V_{CC} = 2.7V$  to  $5.5V$ ,  $V_{LOGIC} = 1.2V$  to  $5.5V$  over recommended operating conditions unless otherwise stated. **Boldface limits apply over the operating temperature range, -40°C to +125°C.**

SYMBOL	PARAMETER	TEST CONDITIONS	MIN (Note 20)	TYP (Note 8)	MAX (Note 20)	UNITS	
$R_{TOTAL}$	RH to RL Resistance	W option		10		k $\Omega$	
		U option		50		k $\Omega$	
		T option		100		k $\Omega$	
	RH to RL Resistance Tolerance		<b>-20</b>	$\pm 2$	<b>+20</b>	%	
	End-to-End Temperature Coefficient	W option			125		ppm/°C
		U option			65		ppm/°C
T option				45		ppm/°C	
$V_{RH}, V_{RL}$	DCP Terminal Voltage	$V_{RH}$ or $V_{RL}$ to GND	<b>0</b>		$V_{CC}$	V	
RW	Wiper Resistance	RH - floating, $V_{RL} = 0V$ , force $I_W$ current to the wiper, $I_W = (V_{CC} - V_{RL})/R_{TOTAL}$ , $V_{CC} = 2.7V$ to $5.5V$		70	<b>200</b>	$\Omega$	
		$V_{CC} = 1.7V$		580		$\Omega$	
$C_H/C_L/C_W$	Terminal Capacitance	See "DCP Macro Model" on page 9		32/32/32		pF	
$I_{LkgDCP}$	Leakage on DCP Pins	Voltage at pin from GND to $V_{CC}$	<b>-0.4</b>	< 0.1	<b>0.4</b>	$\mu A$	
Noise	Resistor Noise Density	Wiper at middle point, W option		16		nV/ $\sqrt{Hz}$	
		Wiper at middle point, U option		49		nV/ $\sqrt{Hz}$	
		Wiper at middle point, T option		61		nV/ $\sqrt{Hz}$	
Feed Thru	Digital Feed-through from Bus to Wiper	Wiper at middle point		-65		dB	
PSRR	Power Supply Reject Ratio	Wiper output change if $V_{CC}$ change $\pm 10\%$ ; wiper at middle point		-75		dB	

**Analog Specifications**

$V_{CC} = 2.7V$  to  $5.5V$ ,  $V_{LOGIC} = 1.2V$  to  $5.5V$  over recommended operating conditions unless otherwise stated. **Boldface limits apply over the operating temperature range,  $-40^{\circ}C$  to  $+125^{\circ}C$ .** (Continued)

SYMBOL	PARAMETER	TEST CONDITIONS	MIN (Note 20)	TYP (Note 8)	MAX (Note 20)	UNITS
<b>VOLTAGE DIVIDER MODE (0V @ RL; <math>V_{CC}</math> @ RH; measured at RW, unloaded)</b>						
INL (Note 13)	Integral Non-linearity, Guaranteed Monotonic	W option	<b>-1.0</b>	$\pm 0.5$	<b>+1.0</b>	LSB (Note 9)
		U, T option	<b>-0.5</b>	$\pm 0.15$	<b>+0.5</b>	LSB (Note 9)
DNL (Note 12)	Differential Non-linearity, Guaranteed Monotonic	W option	<b>-1</b>	$\pm 0.4$	<b>+1</b>	LSB (Note 9)
		U, T option	<b>-0.4</b>	$\pm 0.1$	<b>+0.4</b>	LSB (Note 9)
FSerror (Note 11)	Full-scale Error	W option	<b>-5</b>	-2	<b>0</b>	LSB (Note 9)
		U, T option	<b>-2</b>	-0.5	<b>0</b>	LSB (Note 9)
ZSerror (Note 10)	Zero-scale Error	W option	<b>0</b>	2	<b>5</b>	LSB (Note 9)
		U, T option	<b>0</b>	0.4	<b>2</b>	LSB (Note 9)
Vmatch (Note 22)	DCP to DCP Matching	DCPs at same tap position, same voltage at all RH terminals, and same voltage at all RL terminals	<b>-2</b>	$\pm 0.5$	<b>2</b>	LSB (Note 9)
TC <sub>V</sub> (Notes 14)	Ratiometric Temperature Coefficient	W option, Wiper Register set to 80 hex		8		ppm/ $^{\circ}C$
		U option, Wiper Register set to 80 hex		4		ppm/ $^{\circ}C$
		T option, Wiper Register set to 80 hex		2.3		ppm/ $^{\circ}C$
t <sub>LS_Settling</sub>	Large Signal Wiper Settling Time	From code 0 to FF hex, measured from 0 to 1LSB settling of the wiper		300		ns
f <sub>cutoff</sub>	-3dB Cutoff Frequency	Wiper at middle point W option		1200		kHz
		Wiper at middle point U option		250		kHz
		Wiper at middle point T option		120		kHz
<b>RHEOSTAT MODE (Measurements between RW and RL pins with RH not connected, or between RW and RH with RL not connected)</b>						
R <sub>INL</sub> (Note 18)	Integral Non-linearity, Guaranteed Monotonic	W option; $V_{CC} = 2.7V$ to $5.5V$	<b>-2.0</b>	$\pm 1$	<b>+2.0</b>	MI (Note 15)
		W option; $V_{CC} = 1.7V$		10.5		MI (Note 15)
		U, T option; $V_{CC} = 2.7V$ to $5.5V$	<b>-1.0</b>	$\pm 0.3$	<b>+1.0</b>	MI (Note 15)
		U, T option; $V_{CC} = 1.7V$		2.1		MI (Note 15)
R <sub>DNL</sub> (Note 17)	Differential Non-linearity, Guaranteed Monotonic	W option; $V_{CC} = 2.7V$ to $5.5V$	<b>-1</b>	$\pm 0.4$	<b>+1</b>	MI (Note 15)
		W option; $V_{CC} = 1.7V$		$\pm 0.6$		MI (Note 15)
		U, T option; $V_{CC} = 2.7V$ to $5.5V$	<b>-0.5</b>	$\pm 0.15$	<b>+0.5</b>	MI (Note 15)
		U, T option; $V_{CC} = 1.7V$		$\pm 0.35$		MI (Note 15)

**Analog Specifications**

$V_{CC} = 2.7V$  to  $5.5V$ ,  $V_{LOGIC} = 1.2V$  to  $5.5V$  over recommended operating conditions unless otherwise stated. **Boldface limits apply over the operating temperature range,  $-40^{\circ}C$  to  $+125^{\circ}C$ .** (Continued)

SYMBOL	PARAMETER	TEST CONDITIONS	MIN (Note 20)	TYP (Note 8)	MAX (Note 20)	UNITS
$R_{offset}$ (Note 16)	Offset, Wiper at 0 Position	W option; $V_{CC} = 2.7V$ to $5.5V$	<b>0</b>	3	<b>5.5</b>	MI (Note 15)
		W option; $V_{CC} = 1.7V$		6.3		MI (Note 15)
		U, T option; $V_{CC} = 2.7V$ to $5.5V$	<b>0</b>	0.5	<b>2</b>	MI (Note 15)
		U, T option; $V_{CC} = 1.7V$		1.1		MI (Note 15)
$R_{match}$ (Note 23)	DCP to DCP Matching	Any two DCPs at the same tap position with the same terminal voltages	<b>-2</b>		<b>2</b>	LSB (Note 9)
TCR (Note 19)	Resistance Temperature Coefficient	W option; Wiper register set between 32 hex and FF hex		170		ppm/ $^{\circ}C$
		U option; Wiper register set between 32 hex and FF hex		80		ppm/ $^{\circ}C$
		T option; Wiper register set between 32 hex and FF hex		50		ppm/ $^{\circ}C$

**Operating Specifications**

$V_{CC} = 2.7V$  to  $5.5V$ ,  $V_{LOGIC} = 1.2V$  to  $5.5V$  over recommended operating conditions unless otherwise stated. **Boldface limits apply over the operating temperature range,  $-40^{\circ}C$  to  $+125^{\circ}C$ .**

SYMBOL	PARAMETER	TEST CONDITIONS	MIN (Note 20)	TYP (Note 8)	MAX (Note 20)	UNITS
$I_{LOGIC}$	$V_{LOGIC}$ Supply Current (Write/Read)	$V_{LOGIC} = 5.5V$ , $V_{CC} = 5.5V$ , $f_{SCL} = 400$ kHz (for I <sup>2</sup> C active read and write)			<b>200</b>	$\mu A$
		$V_{LOGIC} = 1.2V$ , $V_{CC} = 1.7V$ , $f_{SCL} = 400$ kHz (for I <sup>2</sup> C active read and write)			<b>5</b>	$\mu A$
$I_{CC}$	$V_{CC}$ Supply Current (Write/Read)	$V_{LOGIC} = 5.5V$ , $V_{CC} = 5.5V$			<b>18</b>	$\mu A$
		$V_{LOGIC} = 1.2V$ , $V_{CC} = 1.7V$			<b>10</b>	$\mu A$
$I_{LOGIC\ SB}$	$V_{LOGIC}$ Standby Current	$V_{LOGIC} = V_{CC} = 5.5V$ , I <sup>2</sup> C interface in standby			<b>2</b>	$\mu A$
		$V_{LOGIC} = 1.2V$ , $V_{CC} = 1.7V$ , I <sup>2</sup> C interface in standby			<b>0.5</b>	$\mu A$
$I_{CC\ SB}$	$V_{CC}$ Standby Current	$V_{LOGIC} = V_{CC} = 5.5V$ , I <sup>2</sup> C interface in standby			<b>3</b>	$\mu A$
		$V_{LOGIC} = 1.2V$ , $V_{CC} = 1.7V$ , I <sup>2</sup> C interface in standby			<b>1.5</b>	$\mu A$
$I_{LOGIC\ SHDN}$	$V_{LOGIC}$ Shutdown Current	$V_{LOGIC} = V_{CC} = 5.5V$ , I <sup>2</sup> C interface in standby			<b>2</b>	$\mu A$
		$V_{LOGIC} = 1.2V$ , $V_{CC} = 1.7V$ , I <sup>2</sup> C interface in standby			<b>0.5</b>	$\mu A$
$I_{CC\ SHDN}$	$V_{CC}$ Shutdown Current	$V_{LOGIC} = V_{CC} = 5.5V$ , I <sup>2</sup> C interface in standby			<b>3</b>	$\mu A$
		$V_{LOGIC} = 1.2V$ , $V_{CC} = 1.7V$ , I <sup>2</sup> C interface in standby			<b>1.5</b>	$\mu A$
$I_{LkgDig}$	Leakage Current, at Pins A0, A1, A2, SDA, SCL	Voltage at pin from GND to $V_{LOGIC}$	<b>-0.4</b>	<0.1	<b>0.4</b>	$\mu A$

**Operating Specifications**  $V_{CC} = 2.7V$  to  $5.5V$ ,  $V_{LOGIC} = 1.2V$  to  $5.5V$  over recommended operating conditions unless otherwise stated. **Boldface limits apply over the operating temperature range,  $-40^{\circ}C$  to  $+125^{\circ}C$ .** (Continued)

SYMBOL	PARAMETER	TEST CONDITIONS	MIN (Note 20)	TYP (Note 8)	MAX (Note 20)	UNITS
$t_{DCP}$	Wiper Response Time	SCL rising edge of the acknowledge bit after data byte to wiper new position (Changes from 10% to 90% FS) W, U, T options specified top to bottom		0.4		$\mu s$
				1.5		$\mu s$
				3.5		$\mu s$
$t_{ShdnRec}$	DCP Recall Time from Shutdown Mode	SCL rising edge of the acknowledge bit after ACR data byte to wiper recalled position and RH connection		1.5		$\mu s$
$V_{CC}, V_{LOGIC}$ Ramp (Note 21)	$V_{CC}, V_{LOGIC}$ Ramp Rate	Ramp monotonic at any level	<b>0.01</b>		<b>50</b>	V/ms

**Serial Interface Specification** for SCL, SDA, A0, A1, A2 Unless Otherwise Noted.

SYMBOL	PARAMETER	TEST CONDITIONS	MIN (Note 20)	TYP (Note 8)	MAX (Note 20)	UNITS
$V_{IL}$	Input LOW Voltage		-0.3		$0.3 \times V_{LOGIC}$	V
$V_{IH}$	Input HIGH Voltage		$0.7 \times V_{LOGIC}$		$V_{LOGIC} + 0.3$	V
Hysteresis	SDA and SCL Input Buffer Hysteresis	$V_{LOGIC} > 2V$	$0.05 \times V_{LOGIC}$			V
		$V_{LOGIC} < 2V$	$0.1 \times V_{LOGIC}$			V
$V_{OL}$	SDA Output Buffer LOW Voltage	$I_{OL} = 3mA, V_{LOGIC} > 2V$	0		0.4	V
		$I_{OL} = 1.5mA, V_{LOGIC} < 2V$			$0.2 \times V_{LOGIC}$	V
$C_{pin}$	SDA, SCL Pin Capacitance			10		pF
$f_{SCL}$	SCL Frequency				400	kHz
$t_{sp}$	Pulse Width Suppression Time at SDA and SCL Inputs	Any pulse narrower than the max spec is suppressed			50	ns
$t_{AA}$	SCL Falling Edge to SDA Output Data Valid	SCL falling edge crossing 30% of $V_{LOGIC}$ , until SDA exits the 30% to 70% of $V_{LOGIC}$ window			900	ns
$t_{BUF}$	Time the Bus Must be Free Before the Start of a New Transmission	SDA crossing 70% of $V_{LOGIC}$ during a STOP condition, to SDA crossing 70% of $V_{LOGIC}$ during the following START condition	1300			ns
$t_{LOW}$	Clock LOW Time	Measured at the 30% of $V_{LOGIC}$ crossing	1300			ns
$t_{HIGH}$	Clock HIGH Time	Measured at the 70% of $V_{LOGIC}$ crossing	600			ns
$t_{SU:STA}$	START Condition Set-up Time	SCL rising edge to SDA falling edge; both crossing 70% of $V_{LOGIC}$	600			ns
$t_{HD:STA}$	START Condition Hold Time	From SDA falling edge crossing 30% of $V_{LOGIC}$ to SCL falling edge crossing 70% of $V_{LOGIC}$	600			ns
$t_{SU:DAT}$	Input Data Set-up Time	From SDA exiting the 30% to 70% of $V_{LOGIC}$ window, to SCL rising edge crossing 30% of $V_{LOGIC}$	100			ns
$t_{HD:DAT}$	Input Data Hold Time	From SCL falling edge crossing 70% of $V_{LOGIC}$ to SDA entering the 30% to 70% of $V_{LOGIC}$ window	0			ns
$t_{SU:STO}$	STOP Condition Set-up Time	From SCL rising edge crossing 70% of $V_{LOGIC}$ , to SDA rising edge crossing 30% of $V_{LOGIC}$	600			ns
$t_{HD:STO}$	STOP Condition Hold Time for Read or Write	From SDA rising edge to SCL falling edge; both crossing 70% of $V_{LOGIC}$	1300			ns

**Serial Interface Specification** for SCL, SDA, A0, A1, A2 Unless Otherwise Noted. (Continued)

SYMBOL	PARAMETER	TEST CONDITIONS	MIN (Note 20)	TYP (Note 8)	MAX (Note 20)	UNITS
$t_{DH}$	Output Data Hold Time	From SCL falling edge crossing 30% of $V_{LOGIC}$ , until SDA enters the 30% to 70% of $V_{LOGIC}$ window. $I_{OL} = 3mA$ , $V_{LOGIC} > 2V$ . $I_{OL} = 0.5mA$ , $V_{LOGIC} < 2V$	0			ns
$t_R$	SDA and SCL Rise Time	From 30% to 70% of $V_{LOGIC}$	$20 + 0.1 \times C_b$		250	ns
$t_F$	SDA and SCL Fall Time	From 70% to 30% of $V_{LOGIC}$	$20 + 0.1 \times C_b$		250	ns
$C_b$	Capacitive Loading of SDA or SCL	Total on-chip and off-chip	10		400	pF
$t_{SU:A}$	A1, A0, A2 Setup Time	Before START condition	600			ns
$t_{HD:A}$	A1, A0, A2 Hold Time	After STOP condition	600			ns

## NOTES:

8. Typical values are for  $T_A = +25^\circ C$  and 3.3V supply voltages.
9.  $LSB = [V(RW)_{255} - V(RW)_0]/255$ .  $V(RW)_{255}$  and  $V(RW)_0$  are  $V(RW)$  for the DCP register set to FF hex and 00 hex respectively. LSB is the incremental voltage when changing from one tap to an adjacent tap.
10.  $ZS\ error = V(RW)_0/LSB$ .
11.  $FS\ error = [V(RW)_{255} - V_{CC}]/LSB$ .
12.  $DNL = [V(RW)_i - V(RW)_{i-1}]/LSB - 1$ , for  $i = 1$  to 255.  $i$  is the DCP register setting.
13.  $INL = [V(RW)_i - i \cdot LSB - V(RW)_0]/LSB$  for  $i = 1$  to 255
14.  $TC_V = \frac{Max(V(RW)_i) - Min(V(RW)_i)}{V(RW)_i(+25^\circ C)} \times \frac{10^6}{+165^\circ C}$  for  $i = 16$  to 255 decimal,  $T = -40^\circ C$  to  $+125^\circ C$ .  $Max()$  is the maximum value of the wiper voltage and  $Min()$  is the minimum value of the wiper voltage over the temperature range.
15.  $MI = |RW_{255} - RW_0|/255$ . MI is a minimum increment.  $RW_{255}$  and  $RW_0$  are the measured resistances for the DCP register set to FF hex and 00 hex respectively.
16.  $Roffset = RW_0/MI$ , when measuring between RW and RL.  
 $Roffset = RW_{255}/MI$ , when measuring between RW and RH.
17.  $RDNL = (RW_i - RW_{i-1})/MI - 1$ , for  $i = 16$  to 255.
18.  $RINL = [RW_i - (MI \cdot i) - RW_0]/MI$ , for  $i = 16$  to 255.
19.  $TC_R = \frac{[Max(Ri) - Min(Ri)]}{Ri(+25^\circ C)} \times \frac{10^6}{+165^\circ C}$  for  $i = 16$  to 255,  $T = -40^\circ C$  to  $+125^\circ C$ .  $Max()$  is the maximum value of the resistance and  $Min()$  is the minimum value of the resistance over the temperature range.
20. Compliance to datasheet limits is assured by one or more methods: production test, characterization and/or design.
21. It is preferable to ramp up both the  $V_{LOGIC}$  and the  $V_{CC}$  supplies at the same time. If this is not possible, it is recommended to ramp-up the  $V_{LOGIC}$  first followed by the  $V_{CC}$ .
22.  $VMATCH = [V(RW_x)_i - V(RW_y)_i]/LSB$ , for  $i = 1$  to 255,  $x = 0$  to 3 and  $y = 0$  to 3.
23.  $RMATCH = (RW_{i,x} - RW_{i,y})/MI$ , for  $i = 1$  to 255,  $x = 0$  to 3 and  $y = 0$  to 3.



## DCP Macro Model

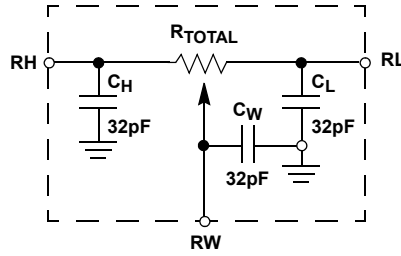

## Timing Diagrams

### SDA vs SCL Timing

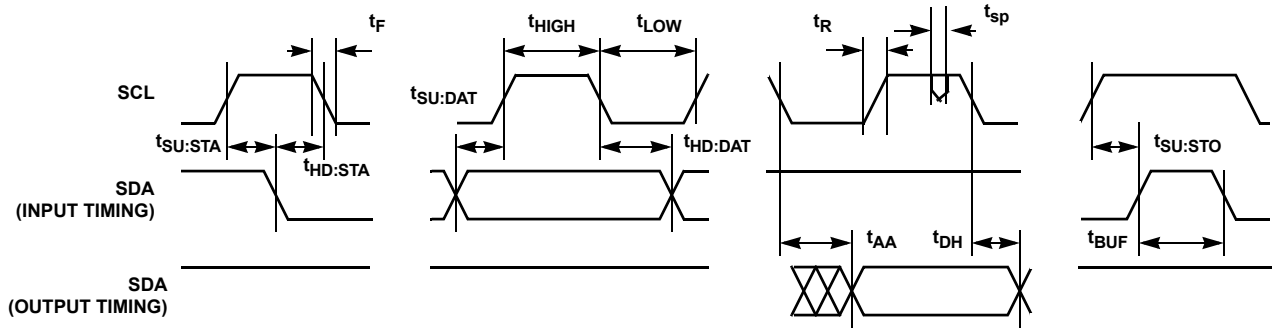

### A0, A1 and A2 Pin Timing

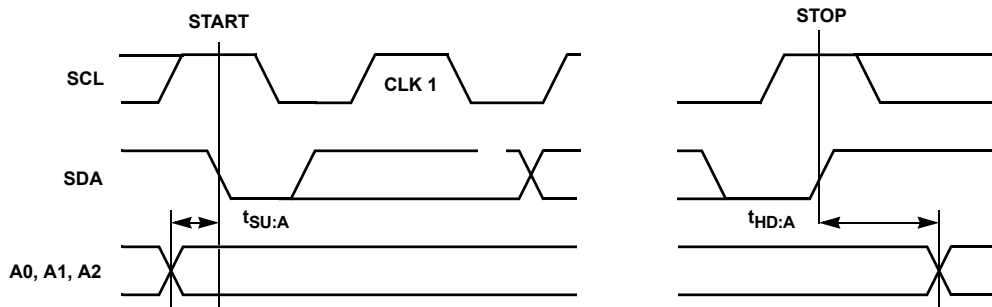

## Typical Performance Curves

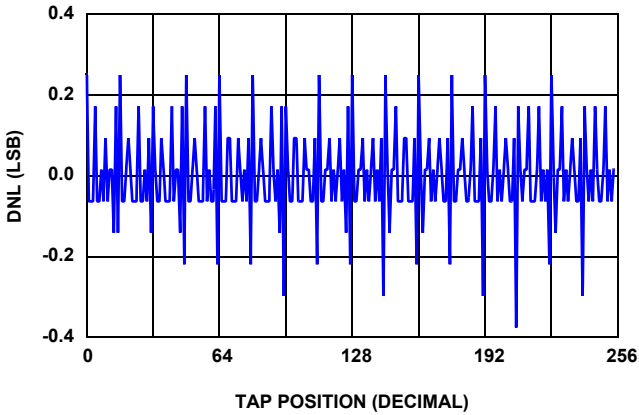

FIGURE 3. 10kΩ DNL vs TAP POSITION,  $V_{CC} = 3.3V, +25^{\circ}C$

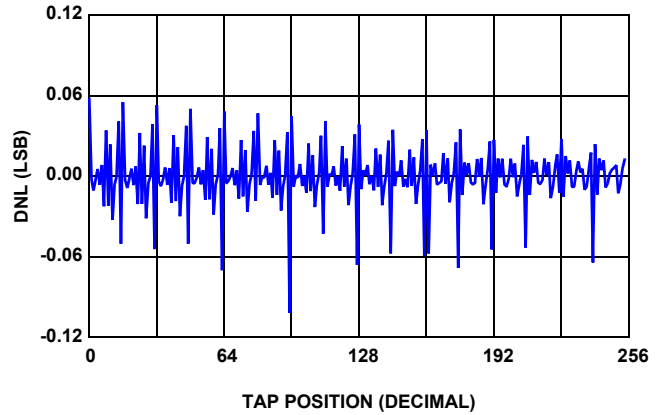

FIGURE 4. 50kΩ DNL vs TAP POSITION,  $V_{CC} = 3.3V, +25^{\circ}C$

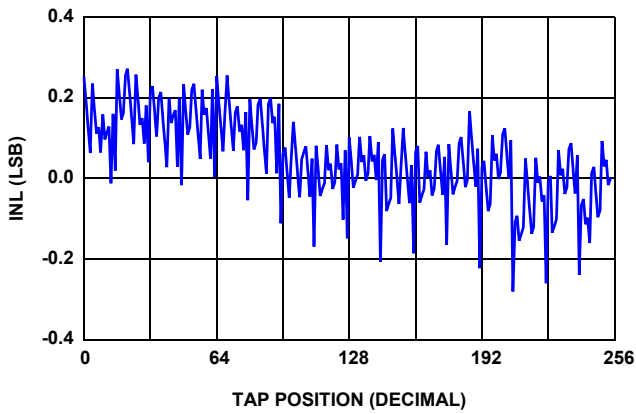

FIGURE 5. 10kΩ INL vs TAP POSITION,  $V_{CC} = 3.3V, +25^{\circ}C$

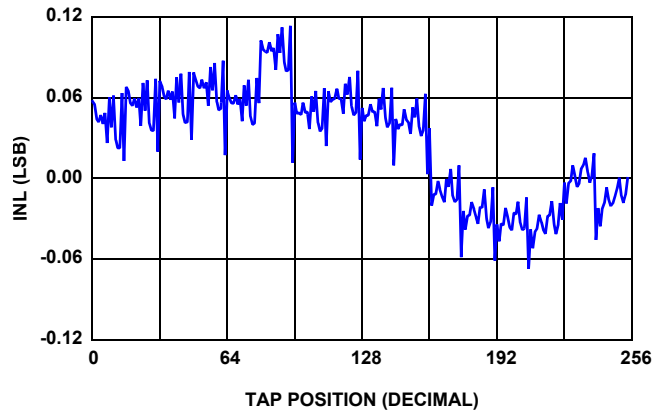

FIGURE 6. 50kΩ INL vs TAP POSITION,  $V_{CC} = 3.3V, +25^{\circ}C$

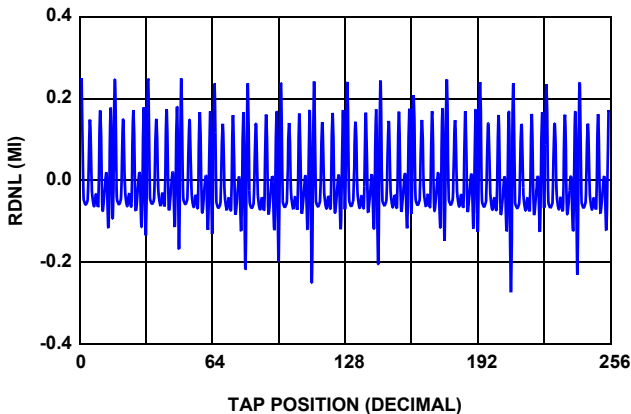

FIGURE 7. 10kΩ RDNL vs TAP POSITION,  $V_{CC} = 3.3V, +25^{\circ}C$

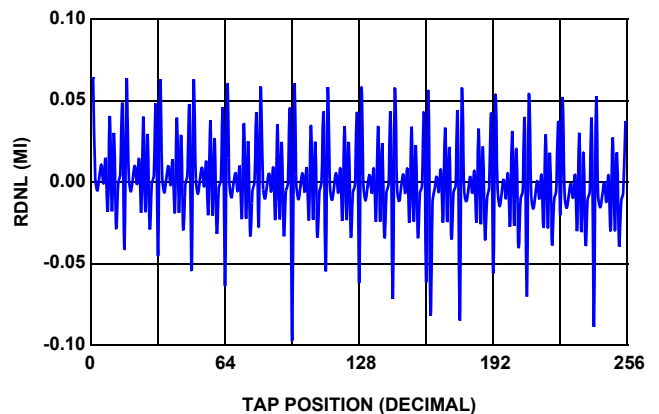

FIGURE 8. 50kΩ RDNL vs TAP POSITION,  $V_{CC} = 3.3V, +25^{\circ}C$

## Typical Performance Curves (Continued)

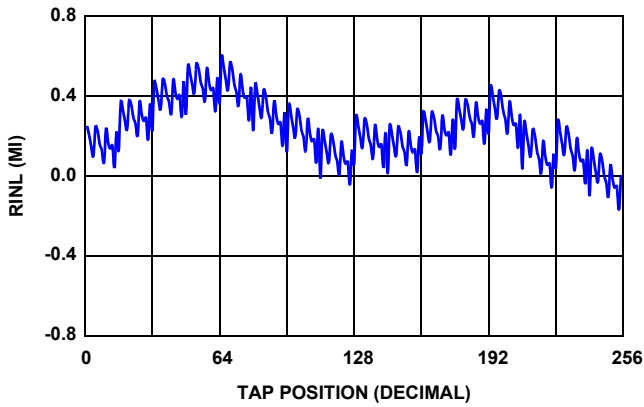

FIGURE 9. 10kΩ RINL vs TAP POSITION,  $V_{CC} = 3.3V$ ,  $+25^{\circ}C$

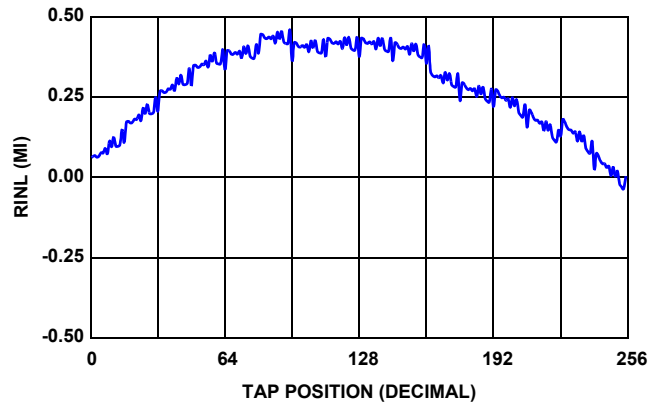

FIGURE 10. 50kΩ RINL vs TAP POSITION,  $V_{CC} = 3.3V$ ,  $+25^{\circ}C$

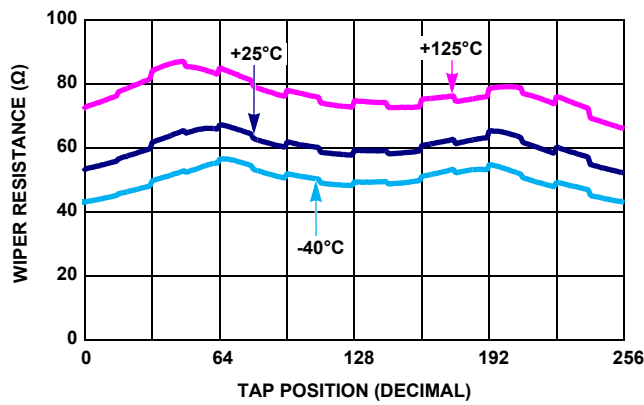

FIGURE 11. 10kΩ WIPER RESISTANCE vs TAP POSITION,  $V_{CC} = 3.3V$

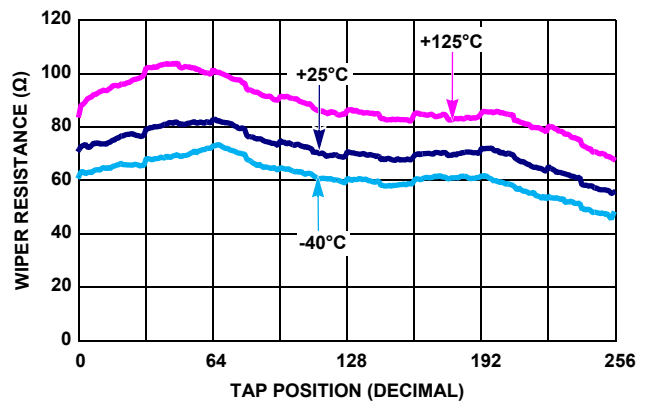

FIGURE 12. 50kΩ WIPER RESISTANCE vs TAP POSITION,  $V_{CC} = 3.3V$

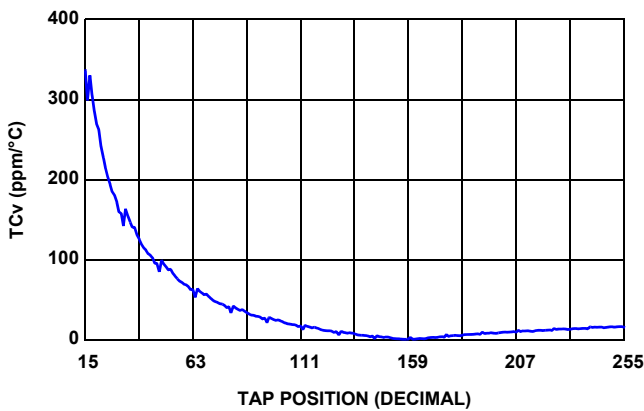

FIGURE 13. 10kΩ TCv vs TAP POSITION,  $V_{CC} = 3.3V$

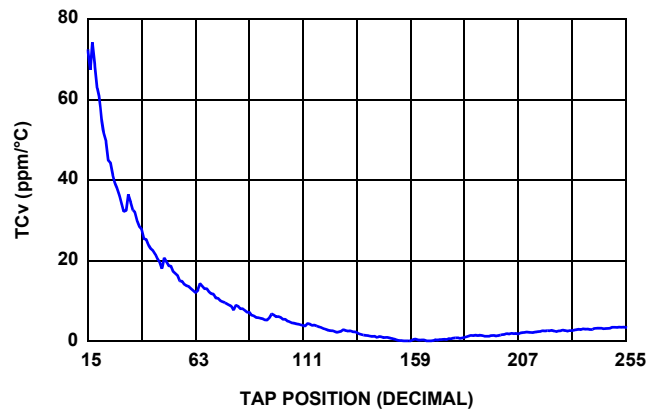

FIGURE 14. 50kΩ TCv vs TAP POSITION,  $V_{CC} = 3.3V$

## Typical Performance Curves (Continued)

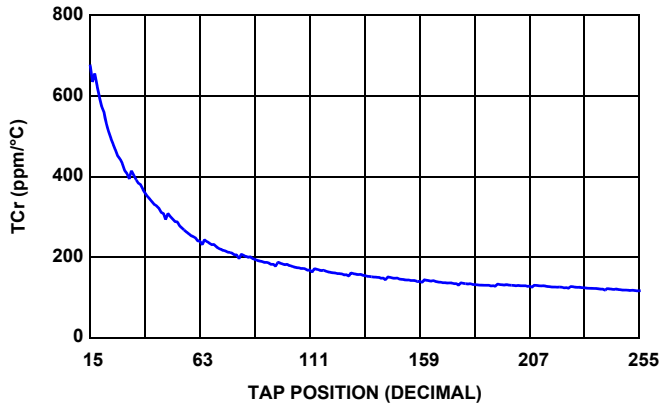

FIGURE 15. 10kΩ TCr vs TAP POSITION

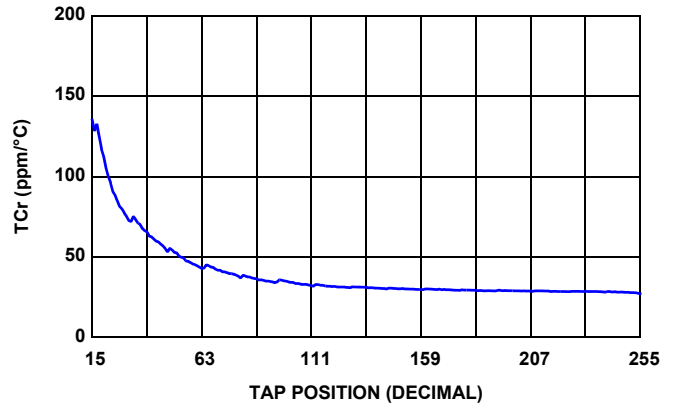

FIGURE 16. 50kΩ TCr vs TAP POSITION,  $V_{CC} = 3.3V$

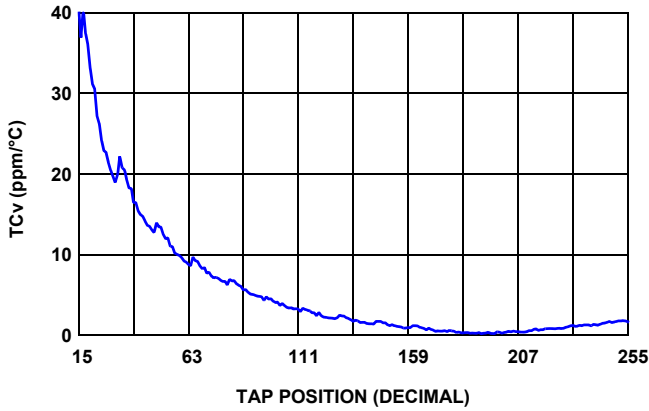

FIGURE 17. 100kΩ TCv vs TAP POSITION,  $V_{CC} = 3.3V$

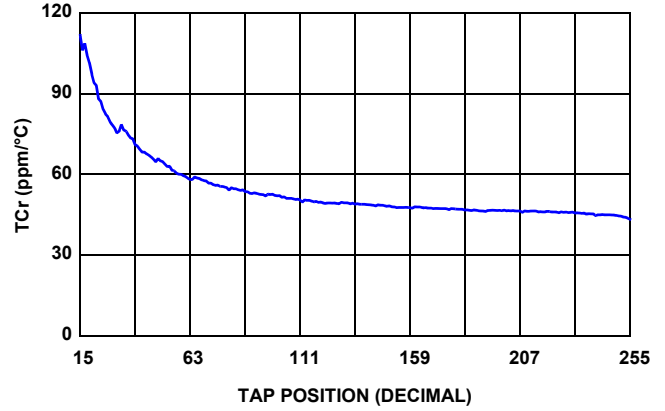

FIGURE 18. 100kΩ TCr vs TAP POSITION,  $V_{CC} = 3.3V$

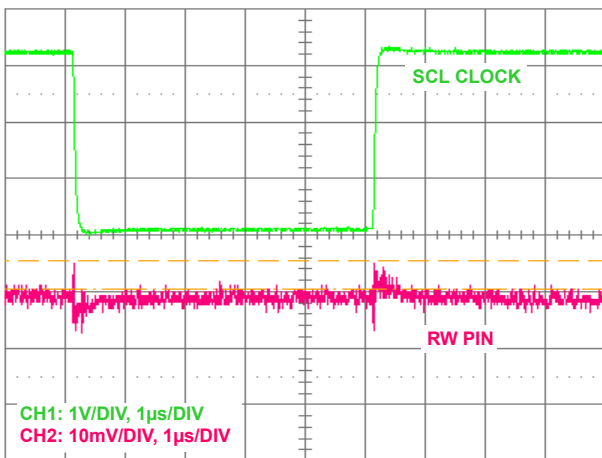

FIGURE 19. WIPER DIGITAL FEED-THROUGH

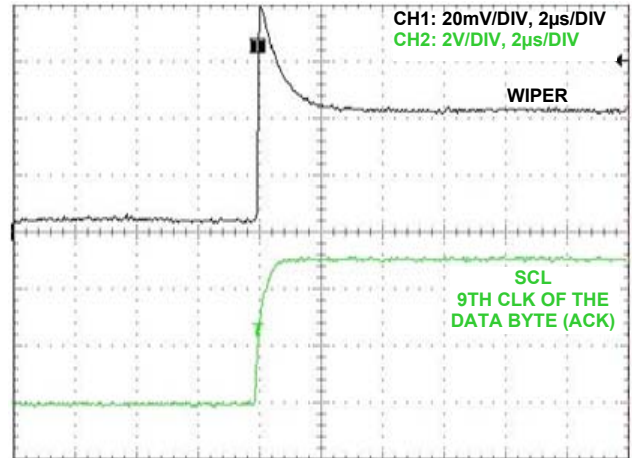

FIGURE 20. WIPER TRANSITION GLITCH

## Typical Performance Curves (Continued)

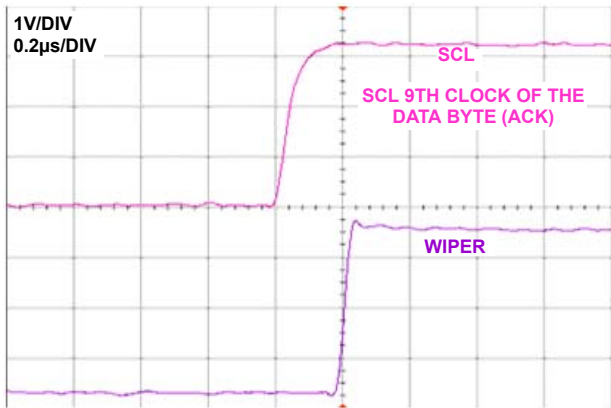

FIGURE 21. WIPER LARGE SIGNAL SETTLING TIME

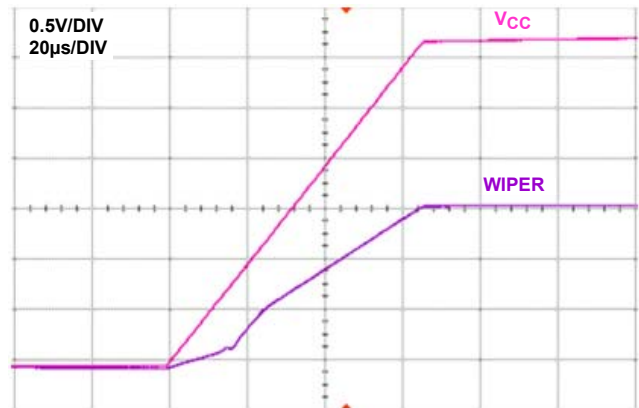

FIGURE 22. POWER-ON START-UP IN VOLTAGE DIVIDER MODE

FIGURE 23. 10k $\Omega$  -3dB CUT OFF FREQUENCY

FIGURE 24. STANDBY CURRENT vs TEMPERATURE

## Functional Pin Descriptions

### Potentiometers Pins

#### RHi AND RLi

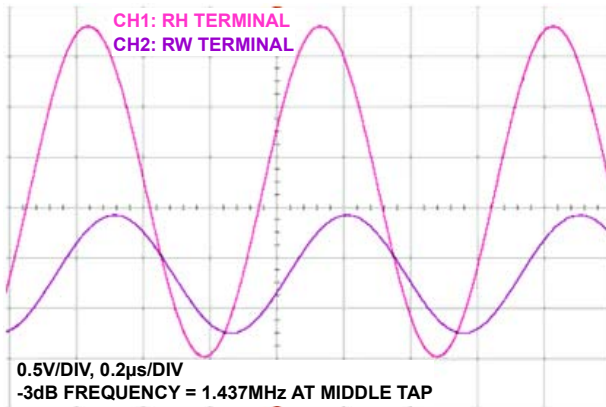
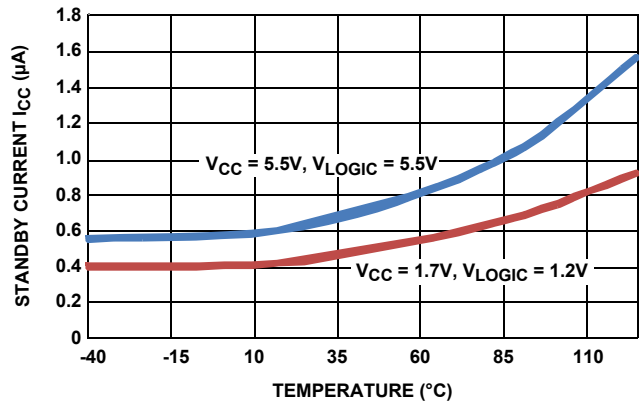
The high (RHi,  $i = 0, 1, 2, 3$ ) and low (RLi,  $i = 0, 1, 2, 3$ ) terminals of the ISL23345 are equivalent to the fixed terminals of a mechanical potentiometer. RHi and RL $i$  are referenced to the relative position of the wiper and not the voltage potential on the terminals. With WR $i$  set to 255 decimal, the wiper will be closest to RHi, and with the WR $i$  set to 0, the wiper is closest to RL $i$ .

#### RWi

RWi ( $i = 0, 1, 3$ ) is the wiper terminal, and it is equivalent to the movable terminal of a mechanical potentiometer. The position of the wiper within the array is determined by the WR $i$  register.

#### V<sub>CC</sub>

Power terminal for the potentiometer section analog power source. Can be any value needed to support the voltage range of the DCP pins, from 1.7V to 5.5V, independent of the V<sub>LOGIC</sub> voltage.

### Bus Interface Pins

#### SERIAL DATA INPUT/OUTPUT (SDA)

The SDA is a bidirectional serial data input/output pin for I<sup>2</sup>C interface. It receives device address, wiper address and data from an I<sup>2</sup>C external master device at the rising edge of the serial clock SCL, and it shifts out data after each falling edge of the serial clock.

SDA requires an external pull-up resistor, since it is an open drain input/output.

#### SERIAL CLOCK (SCL)

This input is the serial clock of the I<sup>2</sup>C serial interface. SCL requires an external pull-up resistor, since a master is an open drain output.

#### DEVICE ADDRESS (A2, A1, A0)

The address inputs are used to set the least significant 3 bits of the 7-bit I<sup>2</sup>C interface slave address. A match in the slave address serial data stream must match with the Address input

pins in order to initiate communication with the ISL23345. A maximum of eight ISL23345 devices may occupy the I<sup>2</sup>C serial bus (see Table 3).

## V<sub>LOGIC</sub>

Digital power source for the logic control section. It supplies an internal level translator for 1.2V to 5.5V serial bus operation. Use the same supply as the I<sup>2</sup>C logic source.

## Principles of Operation

The ISL23345 is an integrated circuit incorporating four DCPs with its associated registers and an I<sup>2</sup>C serial interface providing direct communication between a host and the potentiometer. The resistor array is comprised of individual resistors connected in series. At either end of the array and between each resistor is an electronic switch that transfers the potential at that point to the wiper.

The electronic switches on the device operate in a “make-before-break” mode when the wiper changes tap positions.

Voltage at any of the DCP pins, RHi, RLi or RWi, should not exceed V<sub>CC</sub> level at any conditions during power-up and normal operation.

The V<sub>LOGIC</sub> pin is the terminal for the logic control digital power source. It should use the same supply as the I<sup>2</sup>C logic source, which allows reliable communication with a wide range of microcontrollers and is independent from the V<sub>CC</sub> level. This is extremely important in systems where the master supply has lower levels than the DCP analog supply.

## DCP Description

Each DCP is implemented with a combination of resistor elements and CMOS switches. The physical ends of each DCP are equivalent to the fixed terminals of a mechanical potentiometer (RHi and RLi pins). The RWi pin of the DCP is connected to intermediate nodes, and is equivalent to the wiper terminal of a mechanical potentiometer. The position of the wiper terminal within the DCP is controlled by an 8-bit volatile Wiper Register (WRi). When the WRi of a DCP contains all zeroes (WRi[7:0] = 00h), its wiper terminal (RW) is closest to its “Low” terminal (RLi). When the WRi register of a DCP contains all ones (WRi[7:0] = FFh), its wiper terminal (RWi) is closest to its “High” terminal (RHi). As the value of the WRi increases from all zeroes (0) to all ones (255 decimal), the wiper moves monotonically from the position closest to RLi to the position closest to RHi. At the same time, the resistance between RWi and RLi increases monotonically, while the resistance between RHi and RWi decreases monotonically.

While the ISL23345 is being powered up, all the wipers (WRi) are reset to 80h (128 decimal), which positions RWi at the center between RLi and RHi.

The WRi can be read or written to directly using the I<sup>2</sup>C serial interface as described in the following sections.

## Memory Description

The ISL23345 contains five volatile 8-bit registers: Wiper Register WR0, Wiper Register WR1, Wiper Register WR2, Wiper Register WR3 and Access Control Register (ACR). The memory map of

ISL23345 is shown in Table 1. The Wiper Register WRi at address i contains current wiper position of DCPi (i = 0, 1, 2, 3). The Access Control Register (ACR) at address 10h contains information and control bits described in Table 2.

TABLE 1. MEMORY MAP

ADDRESS (hex)	VOLATILE REGISTER NAME	DEFAULT SETTING (hex)
10	ACR	40
3	WR3	80
2	WR2	80
1	WR1	80
0	WR0	80

TABLE 2. ACCESS CONTROL REGISTER (ACR)

BIT #	7	6	5	4	3	2	1	0
NAME/VALUE	0	$\overline{\text{SHDN}}$	0	0	0	0	0	0

## Shutdown Function

The  $\overline{\text{SHDN}}$  bit (ACR[6]) disables or enables shutdown mode for all DCP channels simultaneously. When this bit is 0, i.e. DCP is forced to end-to-end open circuit and RW is connected to RL through a 2k $\Omega$  serial resistor, as shown in Figure 25. The default value of the SHDN bit is 1.

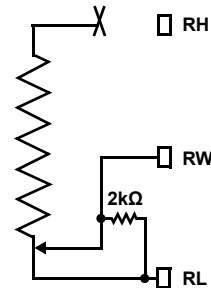

FIGURE 25. DCP CONNECTION IN SHUTDOWN MODE

When the device enters shutdown, all current DCP WRi settings are maintained. When the device exits shutdown, the wipers will return to the previous WRi settings after a short settling time (see Figure 26).

In shutdown mode, if there is a glitch on the power supply which causes it to drop below 1.3V for more than 0.2 $\mu$ s to 0.4 $\mu$ s, the wipers will be RESET to their mid positions. This is done to avoid an undefined state at the wiper outputs.

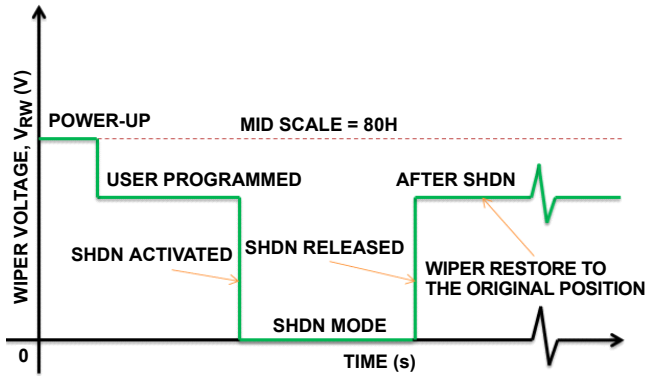

FIGURE 26. SHUTDOWN MODE WIPER RESPONSE

### I<sup>2</sup>C Serial Interface

The ISL23345 supports an I<sup>2</sup>C bidirectional bus oriented protocol. The protocol defines any device that sends data onto the bus as a transmitter and the receiving device as the receiver. The device controlling the transfer is a master and the device being controlled is the slave. The master always initiates data transfers and provides the clock for both transmit and receive operations. Therefore, the ISL23345 operates as a slave device in all applications.

All communication over the I<sup>2</sup>C interface is conducted by sending the MSB of each byte of data first.

### Protocol Conventions

Data states on the SDA line must change only during SCL LOW periods. SDA state changes during SCL HIGH are reserved for indicating START and STOP conditions (see Figure 27). On power-up of the ISL23345, the SDA pin is in the input mode.

All I<sup>2</sup>C interface operations must begin with a START condition, which is a HIGH-to-LOW transition of SDA while SCL is HIGH. The ISL23345 continuously monitors the SDA and SCL lines for the START condition and does not respond to any command until this condition is met (see Figure 27). A START condition is ignored during the power-up of the device.

All I<sup>2</sup>C interface operations must be terminated by a STOP condition, which is a LOW to HIGH transition of SDA while SCL is HIGH (see Figure 27). A STOP condition at the end of a read operation or at the end of a write operation places the device in its standby mode.

An ACK (Acknowledge) is a software convention used to indicate a successful data transfer. The transmitting device, either master or slave, releases the SDA bus after transmitting eight bits. During the ninth clock cycle, the receiver pulls the SDA line LOW to acknowledge the reception of the eight bits of data (see Figure 28).

The ISL23345 responds with an ACK after recognition of a START condition followed by a valid Identification Byte, and once again after successful receipt of an Address Byte. The ISL23345 also responds with an ACK after receiving a Data Byte of a write operation. The master must respond with an ACK after receiving a Data Byte of a read operation.

A valid Identification Byte contains 1010 as the four MSBs, and the following three bits are matching the logic values present at pins A2, A1 and A0. The LSB is the Read/Write bit. Its value is "1" for a Read operation and "0" for a Write operation (see Table 3).

TABLE 3. IDENTIFICATION BYTE FORMAT  
LOGIC VALUES AT PINS A2, A1 AND A0 RESPECTIVELY

1	0	1	0	A2	A1	A0	R/W
(MSB)				(LSB)			

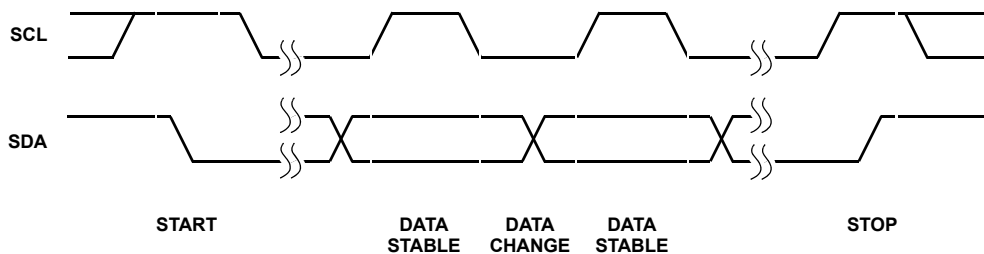

FIGURE 27. VALID DATA CHANGES, START AND STOP CONDITIONS

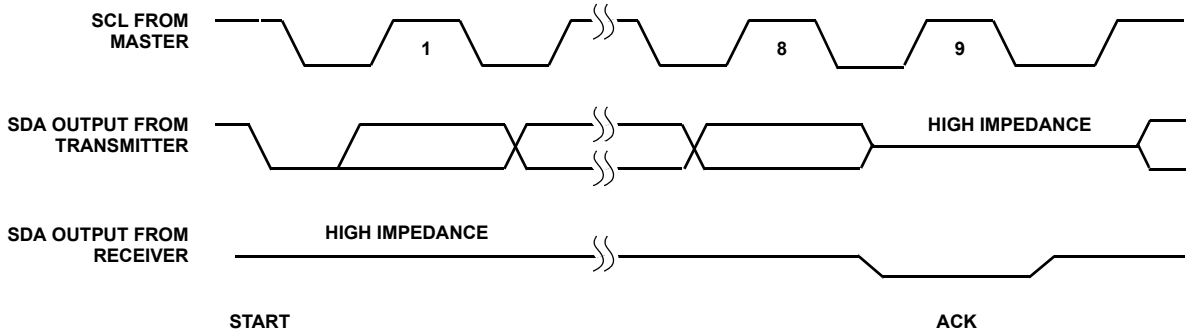

FIGURE 28. ACKNOWLEDGE RESPONSE FROM RECEIVER

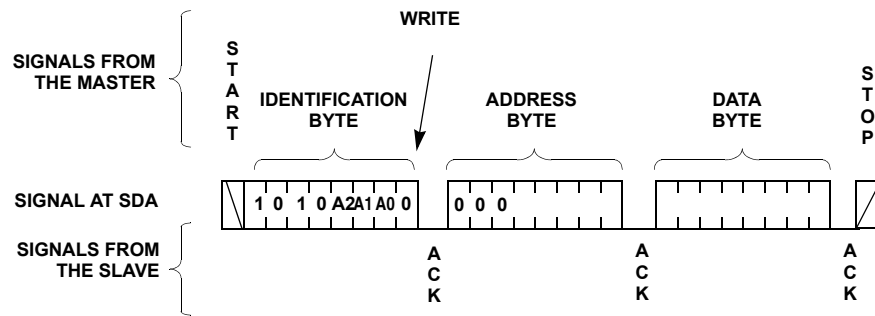

FIGURE 29. BYTE WRITE SEQUENCE

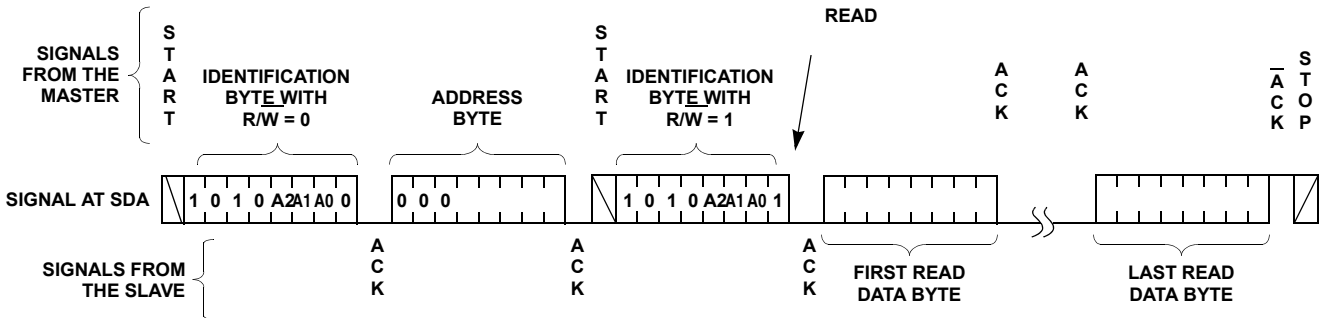

FIGURE 30. READ SEQUENCE

**Write Operation**

A Write operation requires a START condition, followed by a valid Identification Byte, a valid Address Byte, a Data Byte, and a STOP condition. After each of the three bytes, the ISL23345 responds with an ACK. The data is transferred from I<sup>2</sup>C block to the corresponding register at the 9th clock of the data byte and device enters its standby state (see Figures 28 and 29).

It is possible to perform a sequential Write to all DCP channels via a single Write operation. The command is initiated by sending an additional Data Byte after the first Data byte instead of sending a STOP condition.

**Read Operation**

A Read operation consists of a three byte instruction followed by one or more Data Bytes (see Figure 30). The master initiates the operation issuing the following sequence: a START, the Identification byte with the R/W bit set to “0”, an Address Byte, a second START, and a second Identification byte with the R/W bit set to “1”. After each of the three bytes, the ISL23345 responds with an ACK; then the ISL23345 transmits Data Byte. The master terminates the read operation issuing a NACK (ACK) and a STOP condition following the last bit of the last Data Byte (see Figure 30).



## Applications Information

### V<sub>LOGIC</sub> Requirements

V<sub>LOGIC</sub> should be powered continuously during normal operation. In a case where turning V<sub>LOGIC</sub> OFF is necessary, it is recommended to ground the V<sub>LOGIC</sub> pin of the ISL23345. Grounding the V<sub>LOGIC</sub> pin or both V<sub>LOGIC</sub> and V<sub>CC</sub> does not affect other devices on the same bus. It is good practice to put a 1 $\mu$ F cap in parallel to 0.1 $\mu$ F as close to the V<sub>LOGIC</sub> pin as possible.

### V<sub>CC</sub> Requirements and Placement

It is recommended to put a 1 $\mu$ F capacitor in parallel with 0.1 $\mu$ F decoupling capacitor close to the V<sub>CC</sub> pin.

### Wiper Transition

When stepping up through each tap in voltage divider mode, some tap transition points can result in noticeable voltage transients, or overshoot/undershoot, resulting from the sudden transition from a very low impedance "make" to a much higher impedance "break" within a short period of time (<1 $\mu$ s). There are several code transitions such as 0Fh to 10h, 1Fh to 20h, ..., EFh to FFh, which have higher transient glitch. Note, that all switching transients will settle well within the settling time as stated in the datasheet. A small capacitor can be added externally to reduce the amplitude of these voltage transients. However, that will also reduce the useful bandwidth of the circuit, thus may not be a good solution for some applications. It may be a good idea, in that case, to use fast amplifiers in a signal chain for fast recovery.

## Revision History

The revision history provided is for informational purposes only and is believed to be accurate, but not warranted. Please go to web to make sure you have the latest Rev.

DATE	REVISION	CHANGE
June 21, 2011	FN7872.0	Initial release.

## Products

Intersil Corporation is a leader in the design and manufacture of high-performance analog semiconductors. The Company's products address some of the industry's fastest growing markets, such as, flat panel displays, cell phones, handheld products, and notebooks. Intersil's product families address power management and analog signal processing functions. Go to [www.intersil.com/products](http://www.intersil.com/products) for a complete list of Intersil product families.

\*For a complete listing of Applications, Related Documentation and Related Parts, please see the respective device information page on intersil.com: [ISL23345](http://www.intersil.com/ISL23345)

To report errors or suggestions for this datasheet, please go to [www.intersil.com/askourstaff](http://www.intersil.com/askourstaff)

FITs are available from our website at <http://rel.intersil.com/reports/search.php>

© Copyright Intersil Americas LLC 2011. All Rights Reserved.

All trademarks and registered trademarks are the property of their respective owners.

For additional products, see [www.intersil.com/en/products.html](http://www.intersil.com/en/products.html)

Intersil products are manufactured, assembled and tested utilizing ISO9001 quality systems as noted in the quality certifications found at [www.intersil.com/en/support/qualandreliability.html](http://www.intersil.com/en/support/qualandreliability.html)

*Intersil products are sold by description only. Intersil may modify the circuit design and/or specifications of products at any time without notice, provided that such modification does not, in Intersil's sole judgment, affect the form, fit or function of the product. Accordingly, the reader is cautioned to verify that datasheets are current before placing orders. Information furnished by Intersil is believed to be accurate and reliable. However, no responsibility is assumed by Intersil or its subsidiaries for its use; nor for any infringements of patents or other rights of third parties which may result from its use. No license is granted by implication or otherwise under any patent or patent rights of Intersil or its subsidiaries.*

For information regarding Intersil Corporation and its products, see [www.intersil.com](http://www.intersil.com)

**Thin Shrink Small Outline Package Family (TSSOP)**

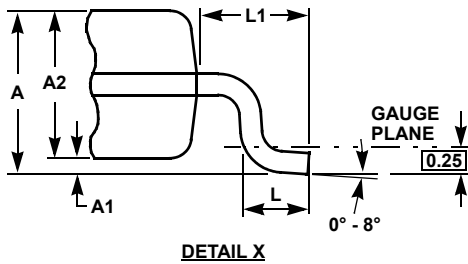
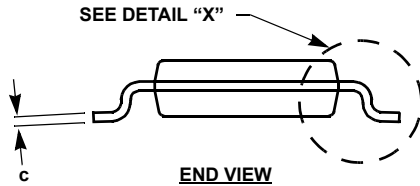
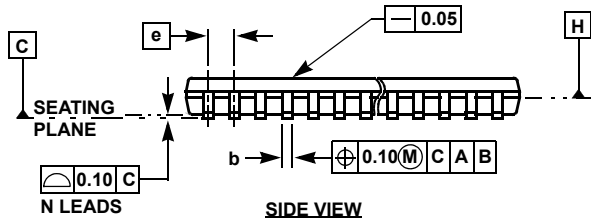
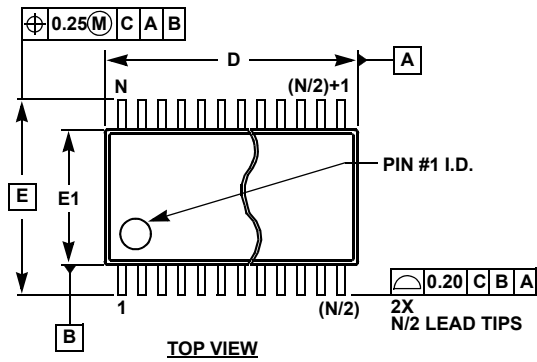

**MDP0044**

**THIN SHRINK SMALL OUTLINE PACKAGE FAMILY**

SYMBOL	MILLIMETERS					TOLERANCE
	14 LD	16 LD	20 LD	24 LD	28 LD	
A	1.20	1.20	1.20	1.20	1.20	Max
A1	0.10	0.10	0.10	0.10	0.10	±0.05
A2	0.90	0.90	0.90	0.90	0.90	±0.05
b	0.25	0.25	0.25	0.25	0.25	+0.05/-0.06
c	0.15	0.15	0.15	0.15	0.15	+0.05/-0.06
D	5.00	5.00	6.50	7.80	9.70	±0.10
E	6.40	6.40	6.40	6.40	6.40	Basic
E1	4.40	4.40	4.40	4.40	4.40	±0.10
e	0.65	0.65	0.65	0.65	0.65	Basic
L	0.60	0.60	0.60	0.60	0.60	±0.15
L1	1.00	1.00	1.00	1.00	1.00	Reference

Rev. F 2/07

**NOTES:**

1. Dimension "D" does not include mold flash, protrusions or gate burrs. Mold flash, protrusions or gate burrs shall not exceed 0.15mm per side.
2. Dimension "E1" does not include interlead flash or protrusions. Interlead flash and protrusions shall not exceed 0.25mm per side.
3. Dimensions "D" and "E1" are measured at dAtum Plane H.
4. Dimensioning and tolerancing per ASME Y14.5M-1994.

# Package Outline Drawing

## L20.3x4

### 20 LEAD QUAD FLAT NO-LEAD PLASTIC PACKAGE

Rev 1, 3/10

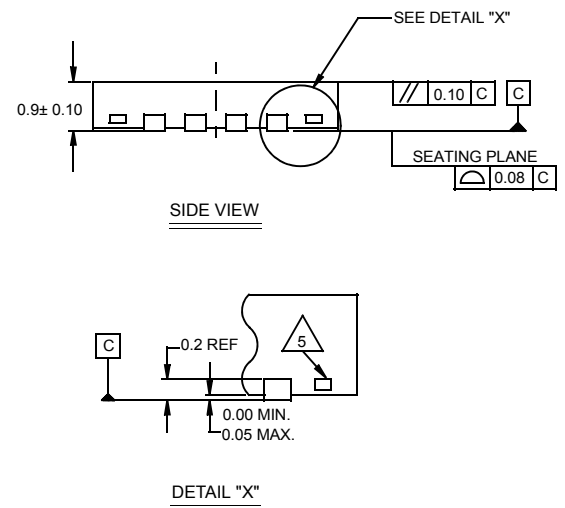
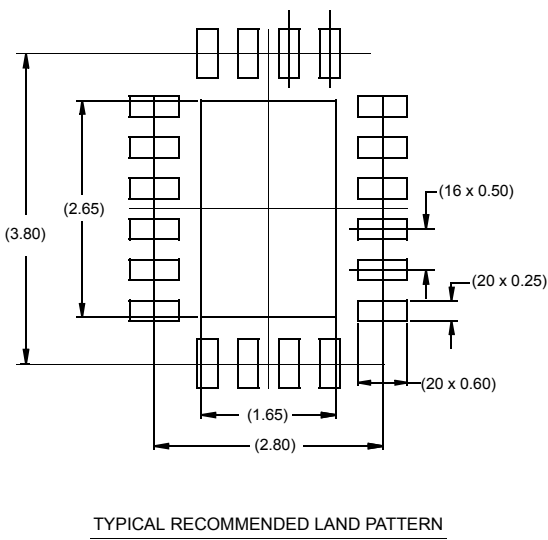
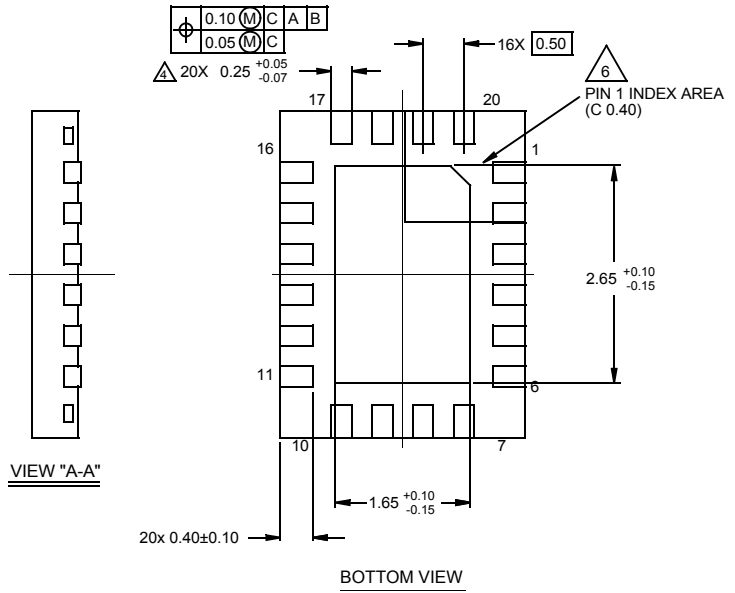
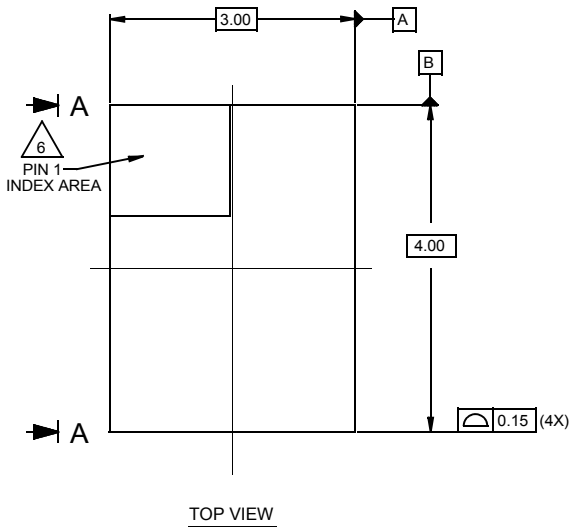

**NOTES:**

1. Dimensions are in millimeters.  
Dimensions in ( ) for Reference Only.
2. Dimensioning and tolerancing conform to AMSE Y14.5m-1994.
3. Unless otherwise specified, tolerance : Decimal ± 0.05
4. Dimension applies to the metallized terminal and is measured between 0.15mm and 0.30mm from the terminal tip.
5. Tiebar shown (if present) is a non-functional feature.
6. The configuration of the pin #1 identifier is optional, but must be located within the zone indicated. The pin #1 identifier may be either a mold or mark feature.