

ISL23418

Single, 128-Tap, Low Voltage Digitally Controlled Potentiometer (XDCP™)

FN7901
Rev 1.00
September 24, 2015

The ISL23418 is a volatile, low voltage, low noise, low power, SPI™ bus, 128 taps, single digitally controlled potentiometer (DCP), which integrates DCP core, wiper switches, and control logic on a monolithic CMOS integrated circuit.

The digitally controlled potentiometer is implemented with a combination of resistor elements and CMOS switches. The position of the wiper is controlled by the user through the SPI bus interface. The potentiometer has an associated volatile Wiper Register (WR) that can be directly written to and read by the user. The contents of the WR controls the position of the wiper. When powered on, the ISL23418 wiper always commences at mid-scale (64-tap position).

The low voltage, low power consumption, and small package size of the ISL23418 make it an ideal choice for use in battery operated equipment. The ISL23418 has a V_{LOGIC} pin allowing down to 1.2V bus operation, independent from the V_{CC} value. This allows for low logic levels to be connected directly to the ISL23418 without passing through a voltage level shifter.

The DCP can be used as a three-terminal potentiometer or as a two-terminal variable resistor in a wide variety of applications including control, parameter adjustments, and signal processing.

Related Literature

- See [ISL23415](#), “Single, Low Voltage Digitally Controlled Potentiometer (XDCP™)”

Features

- 128 Resistor Taps
- SPI Serial Interface
 - No Additional Level Translator for Low Bus Supply
 - Daisy Chaining of Multiple DCP
- Wiper Resistance: 70Ω Typical @ V_{CC} = 3.3V
- Shutdown Mode: Forces DCP into End-to-end Open Circuit; RW Shorted to RL Internally
- Power-on Preset to Mid-scale (64-tap Position)
- Shutdown and Standby Current <2.8μA Max
- Power Supply
 - V_{CC} = 1.7V to 5.5V Analog Power Supply
 - V_{LOGIC} = 1.2V to 5.5V SPI Bus/Logic Power Supply
- DCP Terminal Voltage from 0V to V_{CC}
- 10kΩ, 50kΩ or 100kΩ Total Resistance
- Extended Industrial Temperature Range: -40°C to +125°C
- 10 Ld MSOP or 10 Ld μTQFN Packages
- Pb-free (RoHS compliant)

Applications

- Power Supply Margining
- RF Power Amplifier Bias Compensation
- LCD Bias Compensation
- Gain Adjustment in Battery Powered Instruments
- Portable Medical Equipment Calibration

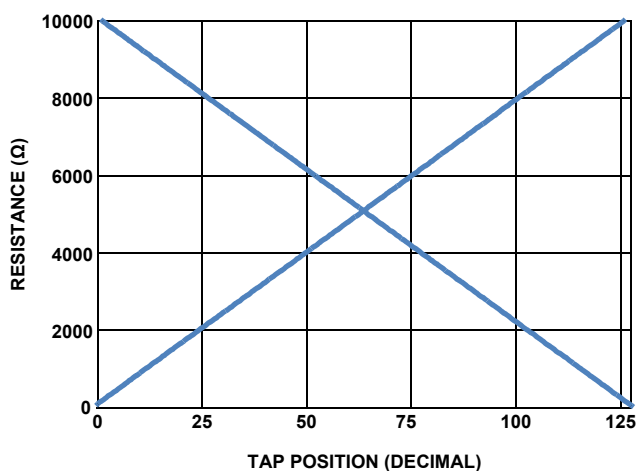

FIGURE 1. FORWARD AND BACKWARD RESISTANCE vs TAP POSITION, 10k

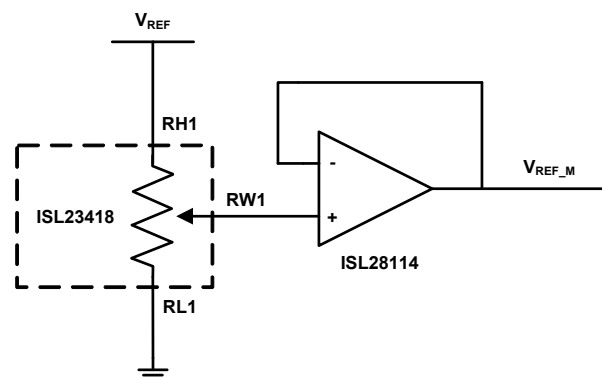
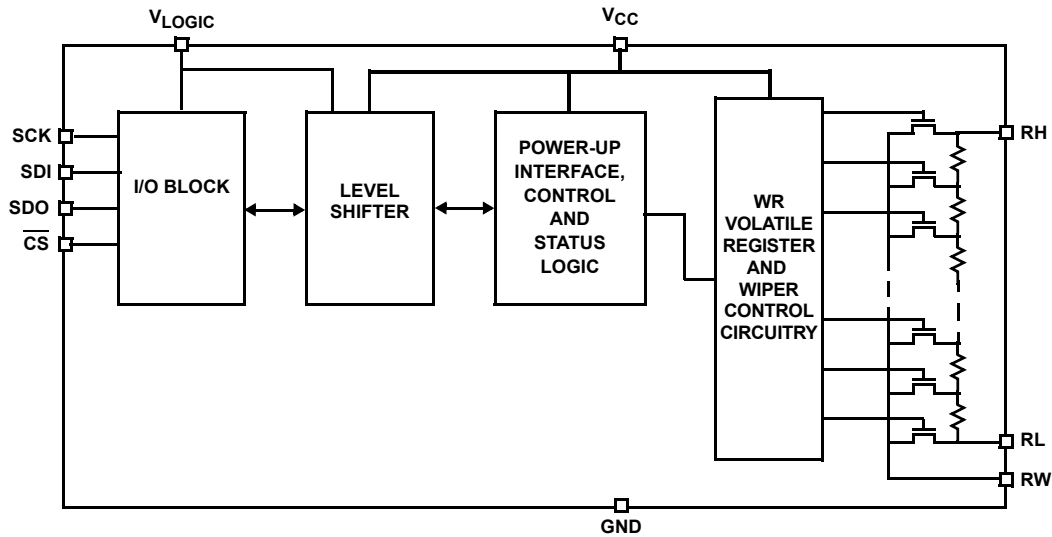
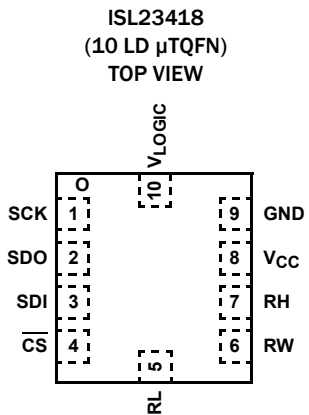
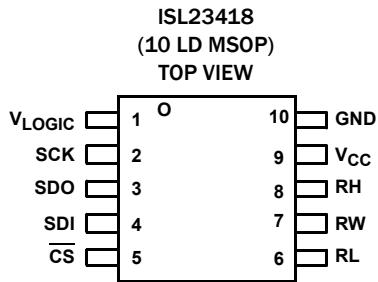

FIGURE 2. V_{REF} ADJUSTMENT

Block Diagram



Pin Configurations



Pin Description

MSOP	μTQFN	SYMBOL	DESCRIPTION
1	10	V _{LOGIC}	SPI bus/logic supply; range 1.2V to 5.5V
2	1	SCK	Logic pin: serial bus clock input
3	2	SDO	Logic pin: serial bus data output (configurable)
4	3	SDI	Logic pin: serial bus data input
5	4	CS	Logic pin: active low Chip Select
6	5	RL	DCP "low" terminal
7	6	RW	DCP wiper terminal
8	7	RH	DCP "high" terminal
9	8	V _{CC}	Analog power supply; range 1.7V to 5.5V
10	9	GND	Ground pin

Ordering Information

PART NUMBER (Note 5)	PART MARKING	RESISTANCE OPTION (k Ω)	TEMP. RANGE (°C)	PACKAGE (RoHS Compliant)	PKG. DWG. #
ISL23418TFUZ (Notes 1, 3)	3418T	100	-40 to +125	10 Ld MSOP	M10.118
ISL23418UFUZ (Notes 1, 3)	3418U	50	-40 to +125	10 Ld MSOP	M10.118
ISL23418WFUZ (Notes 1, 3)	3418W	10	-40 to +125	10 Ld MSOP	M10.118
ISL23418TFRUZ-T7A (Notes 2, 4)	HL	100	-40 to +125	10 Ld 2.1x1.6 μ TQFN	L10.2.1x1.6A
ISL23418TFRUZ-TK (Notes 2, 4)	HL	100	-40 to +125	10 Ld 2.1x1.6 μ TQFN	L10.2.1x1.6A
ISL23418UFRUZ-T7A (Notes 2, 4) (No longer available, recommended replacement: ISL23418TFRUZ-T7A)	HK	50	-40 to +125	10 Ld 2.1x1.6 μ TQFN	L10.2.1x1.6A
ISL23418UFRUZ-TK (Notes 2, 4) (No longer available, recommended replacement: ISL23418TFRUZ-TK)	HK	50	-40 to +125	10 Ld 2.1x1.6 μ TQFN	L10.2.1x1.6A
ISL23418WFRUZ-T7A (Notes 2, 4) (No longer available, recommended replacement: ISL23418TFRUZ-T7A)	HJ	10	-40 to +125	10 Ld 2.1x1.6 μ TQFN	L10.2.1x1.6A
ISL23418WFRUZ-TK (Notes 2, 4) (No longer available, recommended replacement: ISL23418TFRUZ-TK)	HJ	10	-40 to +125	10 Ld 2.1x1.6 μ TQFN	L10.2.1x1.6A

NOTES:

1. Add "-T*" suffix for tape and reel. Please refer to [TB347](#) for details on reel specifications.
2. Please refer to [TB347](#) for details on reel specifications.
3. These Intersil Pb-free plastic packaged products employ special Pb-free material sets, molding compounds/die attach materials, and 100% matte tin plate plus anneal (e3 termination finish, which is RoHS compliant and compatible with both SnPb and Pb-free soldering operations). Intersil Pb-free products are MSL classified at Pb-free peak reflow temperatures that meet or exceed the Pb-free requirements of IPC/JEDEC J STD-020.
4. These Intersil Pb-free plastic packaged products employ special Pb-free material sets; molding compounds/die attach materials and NiPdAu plate e4 termination finish, which is RoHS compliant and compatible with both SnPb and Pb-free soldering operations. Intersil Pb-free products are MSL classified at Pb-free peak reflow temperatures that meet or exceed the Pb-free requirements of IPC/JEDEC J STD-020.
5. For Moisture Sensitivity Level (MSL), please see device information page for [ISL23418](#). For more information on MSL please see Tech Brief [TB363](#).

Absolute Maximum Ratings

Supply Voltage Range	
V_{CC}	-0.3V to 6.0V
V_{LOGIC}	-0.3V to 6.0V
Voltage on any DCP Terminal Pin	-0.3V to 6.0V
Voltage on any Digital Pins	-0.3V to 6.0V
Wiper Current I_W (10s)	±6mA
ESD Rating	
Human Body Model (Tested per JESD22-A114E)	6.5kV
CDM Model (Tested per JESD22-A114E)	1kV
Machine Model (Tested per JESD22-A115-A)	200V
Latch Up	
(Tested per JESD-78B; Class 2, Level A)	100mA @ +125°C

Thermal Information

Thermal Resistance (Typical)	θ_{JA} (°C/W)	θ_{JC} (°C/W)
10 Ld MSOP Package (Notes 6, 7)	170	70
10 Ld μ TQFN Package (Notes 6, 7)	145	90
Maximum Junction Temperature (Plastic Package)	+150°C	
Storage Temperature Range	-65°C to +150°C	
Pb-Free Reflow Profile	see link below	
	http://www.intersil.com/pbfree/Pb-FreeReflow.asp	

Recommended Operating Conditions

Temperature	-40°C to +125°C
V_{CC} Supply Voltage	1.7V to 5.5V
V_{LOGIC} Supply Voltage	1.2V to 5.5V
DCP Terminal Voltage	.0 to V_{CC}
Max Wiper Current	±3mA

CAUTION: Do not operate at or near the maximum ratings listed for extended periods of time. Exposure to such conditions may adversely impact product reliability and result in failures not covered by warranty.

NOTES:

- θ_{JA} is measured with the component mounted on a high effective thermal conductivity test board in free air. See Tech Brief [TB379](#) for details.
- For θ_{JC} , the "case temp" location is taken at the package top center.

Analog Specifications $V_{CC} = 2.7V$ to 5.5V, $V_{LOGIC} = 1.2V$ to 5.5V over recommended operating conditions unless otherwise stated.
Boldface limits apply over the operating temperature range, -40°C to +125°C.

SYMBOL	PARAMETER	TEST CONDITIONS	MIN (Note 20)	TYP (Note 8)	MAX (Note 20)	UNITS	
R_{TOTAL}	R_H to R_L Resistance	W option		10		k Ω	
		U option		50		k Ω	
		T option		100		k Ω	
	R_H to R_L Resistance Tolerance		-20	±2	+20	%	
	End-to-End Temperature Coefficient	W option			175		ppm/°C
		U option			85		ppm/°C
T option				70		ppm/°C	
V_{RH}, V_{RL}	DCP Terminal Voltage	V_{RH} or V_{RL} to GND	0		V_{CC}	V	
R_W	Wiper Resistance	RH - floating, $V_{RL} = 0V$, force I_W current to the wiper, $I_W = (V_{CC} - V_{RL})/R_{TOTAL}$, $V_{CC} = 2.7V$ to 5.5V		70	200	Ω	
		$V_{CC} = 1.7V$		580		Ω	
$C_H/C_L/C_W$	Terminal Capacitance	See "DCP Macro Model" on page 8.		32/32/32		pF	
I_{LkgDCP}	Leakage on DCP Pins	Voltage at pin from GND to V_{CC}	-0.4	<0.1	0.4	μA	
Noise	Resistor Noise Density	Wiper at middle point, W option		16		nV/ \sqrt{Hz}	
		Wiper at middle point, U option		49		nV/ \sqrt{Hz}	
		Wiper at middle point, T option		61		nV/ \sqrt{Hz}	
Feed Thru	Digital Feedthrough from Bus to Wiper	Wiper at middle point		-65		dB	
PSRR	Power Supply Reject Ratio	Wiper output change if V_{CC} change ±10%; wiper at middle point		-75		dB	
VOLTAGE DIVIDER MODE (0V @ R_L; V_{CC} @ R_H; measured at R_W, unloaded)							
INL (Note 13)	Integral Non-linearity, Guaranteed Monotonic	W, U, T option	-0.5	±0.15	+0.5	LSB (Note 9)	

Analog Specifications $V_{CC} = 2.7V$ to $5.5V$, $V_{LOGIC} = 1.2V$ to $5.5V$ over recommended operating conditions unless otherwise stated.
Boldface limits apply over the operating temperature range, -40°C to +125°C. (Continued)

SYMBOL	PARAMETER	TEST CONDITIONS	MIN (Note 20)	TYP (Note 8)	MAX (Note 20)	UNITS
DNL (Note 12)	Differential Non-linearity, Guaranteed Monotonic	W, U, T option	-0.5	±0.15	+0.5	LSB (Note 9)
FSerror (Note 11)	Full-scale Error	W option	-2.5	-1.5	0	LSB (Note 9)
		U, T option	-1.0	-0.7	0	LSB (Note 9)
ZSerror (Note 10)	Zero-scale Error	W option	0	-1.5	2.5	LSB (Note 9)
		U, T option	0	-0.7	1.0	LSB (Note 9)
TC _V (Note 14)	Ratiometric Temperature Coefficient	W option, Wiper Register set to 40 hex		8		ppm/°C
		U option, Wiper Register set to 40 hex		4		ppm/°C
		T option, Wiper Register set to 40 hex		2.3		ppm/°C
t _{LS Settling}	Large Signal Wiper Settling Time	From code 0 to 7F hex		300		ns
f _{cutoff}	-3dB Cutoff Frequency	Wiper at middle point W option		1200		kHz
		Wiper at middle point U option		250		kHz
		Wiper at middle point T option		120		kHz
RHEOSTAT MODE (Measurements between RW and RL pins with RH not connected, or between RW and RH with RL not connected)						
R _{INL} (Note 18)	Integral Non-linearity, Guaranteed Monotonic	W option; V _{CC} = 2.7V to 5.5V	-1.0	±0.5	+1.0	MI (Note 15)
		W option; V _{CC} = 1.7V		±3.0		MI (Note 15)
		U, T option; V _{CC} = 2.7V to 5.5V	-0.5	±0.15	+0.5	MI (Note 15)
		U, T option; V _{CC} = 1.7V		±1.0		MI (Note 15)
R _{DNL} (Note 17)	Differential Non-linearity, Guaranteed Monotonic	W option; V _{CC} = 2.7V to 5.5V	-0.5	±0.15	+0.5	MI (Note 15)
		W option; V _{CC} = 1.7V		±0.4		MI (Note 15)
		U, T option; V _{CC} = 2.7V to 5.5V	-0.5	±0.15	+0.5	MI (Note 15)
		U, T option; V _{CC} = 1.7V		±0.4		MI (Note 15)
R _{offset} (Note 16)	Offset, Wiper at 0 Position	W option; V _{CC} = 2.7V to 5.5V	0	1.8	3.0	MI (Note 15)
		W option; V _{CC} = 1.7V		3.0		MI (Note 15)
		U, T option; V _{CC} = 2.7V to 5.5V	0	0.3	1	MI (Note 15)
		U, T option; V _{CC} = 1.7V		0.5		MI (Note 15)

Analog Specifications $V_{CC} = 2.7V$ to $5.5V$, $V_{LOGIC} = 1.2V$ to $5.5V$ over recommended operating conditions unless otherwise stated.
Boldface limits apply over the operating temperature range, $-40^{\circ}C$ to $+125^{\circ}C$. (Continued)

SYMBOL	PARAMETER	TEST CONDITIONS	MIN (Note 20)	TYP (Note 8)	MAX (Note 20)	UNITS
TCR (Note 19)	Resistance Temperature Coefficient	W option; Wiper register set between 32 hex and 7F hex		220		ppm/ $^{\circ}C$
		U option; Wiper register set between 32 hex and 7F hex		100		ppm/ $^{\circ}C$
		T option; Wiper register set between 32 hex and 7F hex		75		ppm/ $^{\circ}C$

Operating Specifications $V_{CC} = 2.7V$ to $5.5V$, $V_{LOGIC} = 1.2V$ to $5.5V$ over recommended operating conditions unless otherwise stated.
Boldface limits apply over the operating temperature range, $-40^{\circ}C$ to $+125^{\circ}C$.

SYMBOL	PARAMETER	TEST CONDITIONS	MIN (Note 20)	TYP (Note 8)	MAX (Note 20)	UNITS
I_{LOGIC}	V_{LOGIC} Supply Current (Write/Read)	$V_{LOGIC} = 5.5V$, $V_{CC} = 5.5V$, $f_{SCK} = 5MHz$ (for SPI active read and write)			1.5	mA
		$V_{LOGIC} = 1.2V$, $V_{CC} = 1.7V$, $f_{SCK} = 1MHz$ (for SPI active read and write)			30	μA
I_{CC}	V_{CC} Supply Current (Write/Read)	$V_{LOGIC} = 5.5V$, $V_{CC} = 5.5V$			100	μA
		$V_{LOGIC} = 1.2V$, $V_{CC} = 1.7V$			10	μA
$I_{LOGIC\ SB}$	V_{LOGIC} Standby Current	$V_{LOGIC} = V_{CC} = 5.5V$, SPI interface in standby			1.3	μA
		$V_{LOGIC} = 1.2V$, $V_{CC} = 1.7V$, SPI interface in standby			0.4	μA
$I_{CC\ SB}$	V_{CC} Standby Current	$V_{LOGIC} = V_{CC} = 5.5V$, SPI interface in standby			1.5	μA
		$V_{LOGIC} = 1.2V$, $V_{CC} = 1.7V$, SPI interface in standby			1	μA
$I_{LOGIC\ SHDN}$	V_{LOGIC} Shutdown Current	$V_{LOGIC} = V_{CC} = 5.5V$, SPI interface in standby			1.3	μA
		$V_{LOGIC} = 1.2V$, $V_{CC} = 1.7V$, SPI interface in standby			0.4	μA
$I_{CC\ SHDN}$	V_{CC} Shutdown Current	$V_{LOGIC} = V_{CC} = 5.5V$, SPI interface in standby			1.5	μA
		$V_{LOGIC} = 1.2V$, $V_{CC} = 1.7V$, SPI interface in standby			1	μA
I_{LkgDig}	Leakage Current, at Pins \overline{CS} , SDO, SDI, SCK	Voltage at pin from GND to V_{LOGIC}	-0.4	<0.1	0.4	μA
t_{DCP}	Wiper Response Time	W option; \overline{CS} rising edge to wiper new position, from 10% to 90% of final value.		0.4		μs
		U option; \overline{CS} rising edge to wiper new position, from 10% to 90% of final value.		1.5		μs
		T option; \overline{CS} rising edge to wiper new position, from 10% to 90% of final value.		3.5		μs
$t_{ShdnRec}$	DCP Recall Time from Shutdown Mode	\overline{CS} rising edge to wiper recalled position and RH connection		1.5		μs
V_{CC}, V_{LOGIC} Ramp	V_{CC}, V_{LOGIC} Ramp Rate	Ramp monotonic at any level	0.01		50	V/ms

Serial Interface Specification For SCK, SDI, SDO, $\overline{\text{CS}}$, unless otherwise noted.

SYMBOL	PARAMETER	TEST CONDITIONS	MIN (Note 20)	TYP (Note 8)	MAX (Note 20)	UNITS
V _{IL}	Input LOW Voltage		-0.3		0.3 x V _{LOGIC}	V
V _{IH}	Input HIGH Voltage		0.7 x V _{LOGIC}		V _{LOGIC} + 0.3	V
Hysteresis	SDI and SCK Input Buffer Hysteresis	V _{LOGIC} > 2V	0.05 x V _{LOGIC}			V
		V _{LOGIC} < 2V	0.1 x V _{LOGIC}			
V _{OL}	SDO Output Buffer LOW Voltage	I _{OL} = 3mA, V _{LOGIC} > 2V	0		0.4	V
		I _{OL} = 1.5mA, V _{LOGIC} < 2V			0.2 x V _{LOGIC}	V
R _{pu}	SDO Pull-up Resistor Off-chip	Maximum is determined by t _{RO} and t _{FO} with maximum bus load C _b = 30pF, f _{SCK} = 5MHz			1.5	kΩ
C _{pin}	SCK, SDO, SDI, $\overline{\text{CS}}$ Pin Capacitance			10		pF
f _{SCK}	SCK Frequency	V _{LOGIC} = 1.7V to 5.5V			5	MHz
		V _{LOGIC} = 1.2V to 1.6V			1	MHz
t _{CYC}	SPI Clock Cycle Time	V _{LOGIC} ≥ 1.7V	200			ns
t _{WH}	SPI Clock High Time	V _{LOGIC} ≥ 1.7V	100			ns
t _{WL}	SPI Clock Low Time	V _{LOGIC} ≥ 1.7V	100			ns
t _{LEAD}	Lead Time	V _{LOGIC} ≥ 1.7V	250			ns
t _{LAG}	Lag Time	V _{LOGIC} ≥ 1.7V	250			ns
t _{SU}	SDI, SCK and $\overline{\text{CS}}$ Input Setup Time	V _{LOGIC} ≥ 1.7V	50			ns
t _H	SDI, SCK and $\overline{\text{CS}}$ Input Hold Time	V _{LOGIC} ≥ 1.7V	50			ns
t _{RI}	SDI, SCK and $\overline{\text{CS}}$ Input Rise Time	V _{LOGIC} ≥ 1.7V	10			ns
t _{FI}	SDI, SCK and $\overline{\text{CS}}$ Input Fall Time	V _{LOGIC} ≥ 1.7V	10		20	ns
t _{DIS}	SDO Output Disable Time	V _{LOGIC} ≥ 1.7V	0		100	ns
t _{SO}	SDO Output Setup Time	V _{LOGIC} ≥ 1.7V	50			ns
t _V	SDO Output Valid Time	V _{LOGIC} ≥ 1.7V	150			ns
t _{HO}	SDO Output Hold Time	V _{LOGIC} ≥ 1.7V	0			ns
t _{RO}	SDO Output Rise Time	R _{pu} = 1.5k, C _{bus} = 30pF			60	ns
t _{FO}	SDO Output Fall Time	R _{pu} = 1.5k, C _{bus} = 30pF			60	ns
t _{CS}	$\overline{\text{CS}}$ Deselect Time		2			μs

NOTES:

- Typical values are for T_A = +25°C and 3.3V supply voltages.
- LSB = [V(RW)₁₂₇ - V(RW)₀]/127. V(RW)₁₂₇ and V(RW)₀ are V(RW) for the DCP register set to 7F hex and 00 hex, respectively. LSB is the incremental voltage when changing from one tap to an adjacent tap.
- ZS error = V(RW)₀/LSB.
- FS error = [V(RW)₁₂₇ - V_{CC}]/LSB.
- DNL = [V(RW)_i - V(RW)_{i-1}]/LSB - 1, for i = 1 to 127. i is the DCP register setting.
- INL = [V(RW)_i - i • LSB - V(RW)₀]/LSB for i = 1 to 127
- $\tau_{CV} = \frac{\text{Max}(V(RW)_i) - \text{Min}(V(RW)_i)}{V(RW)_i(+25^\circ\text{C})} \times \frac{10^6}{+165^\circ\text{C}}$ for i = 16 to 127 decimal, T = -40°C to +125°C. Max() is the maximum value of the wiper voltage and Min() is the minimum value of the wiper voltage over the temperature range.
- MI = |RW₁₂₇ - RW₀]/127. MI is a minimum increment. RW₁₂₇ and RW₀ are the measured resistances for the DCP register set to 7F hex and 00 hex, respectively.
- Roffset = RW₀/MI, when measuring between RW and RL.
Roffset = RW₁₂₇/MI, when measuring between RW and RH.
- RDNL = (RW_i - RW_{i-1})/MI - 1, for i = 16 to 127.
- RINL = [RW_i - (MI • i) - RW₀]/MI, for i = 16 to 127.
- $\tau_{CR} = \frac{[\text{Max}(R_i) - \text{Min}(R_i)]}{R_i(+25^\circ\text{C})} \times \frac{10^6}{+165^\circ\text{C}}$ for i = 16 to 127, T = -40°C to +125°C. Max() is the maximum value of the resistance and Min() is the minimum value of the resistance over the temperature range.
- Compliance to datasheet limits is assured by one or more methods: production test, characterization and/or design.

DCP Macro Model

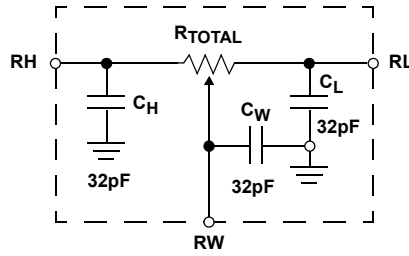

Timing Diagrams

Input Timing

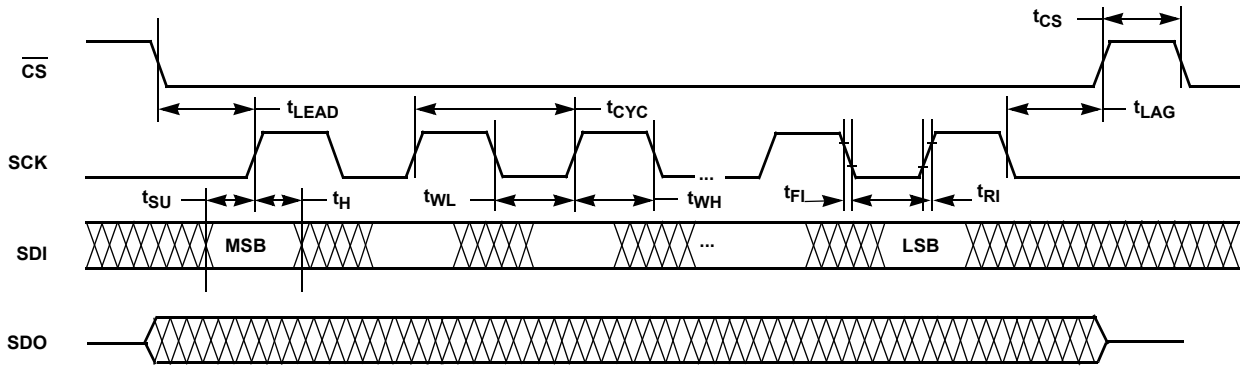

Output Timing

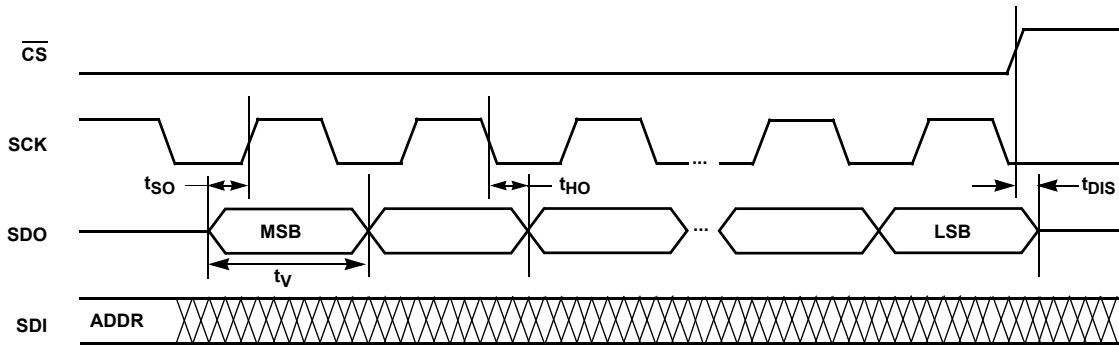

XDCP™ Timing (for All Load Instructions)

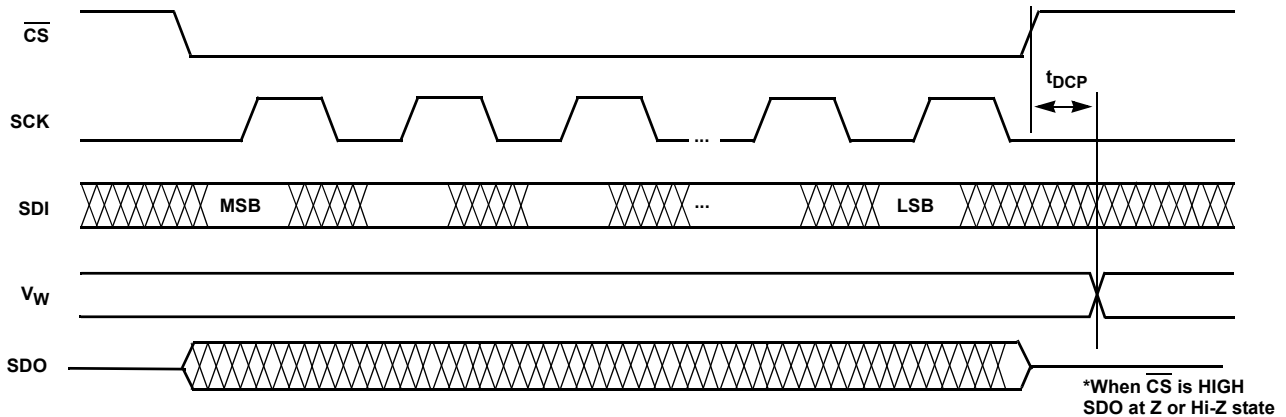

Typical Performance Curves

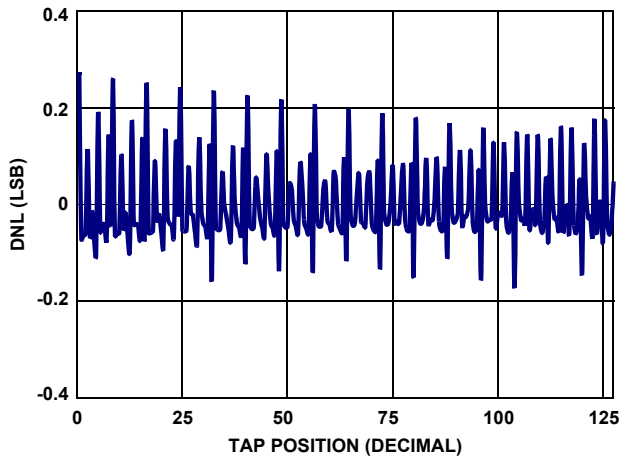

FIGURE 3. 10k DNL vs TAP POSITION, $V_{CC} = 5V$

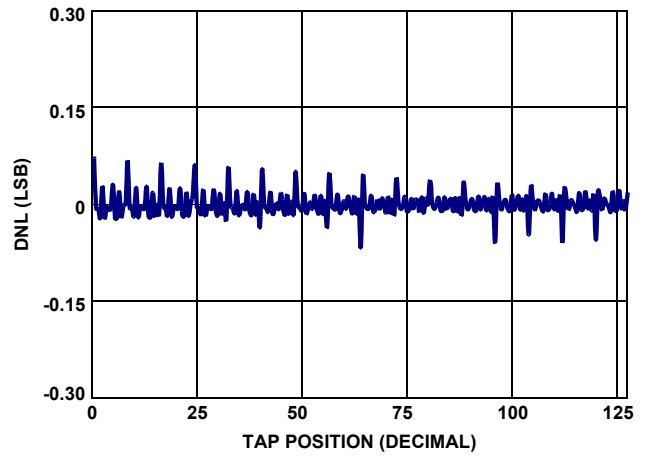

FIGURE 4. 50k DNL vs TAP POSITION, $V_{CC} = 5V$

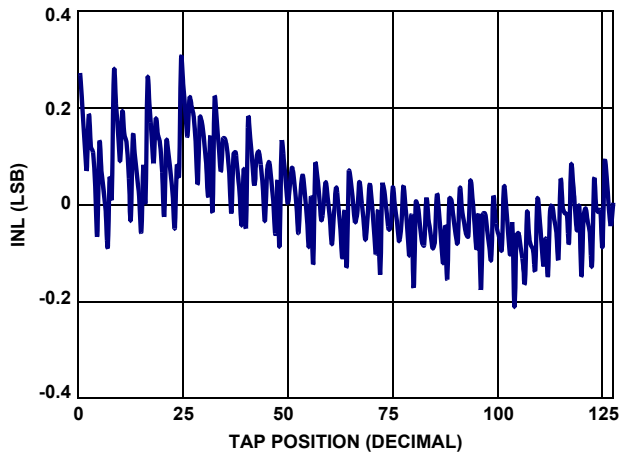

FIGURE 5. 10k INL vs TAP POSITION, $V_{CC} = 5V$

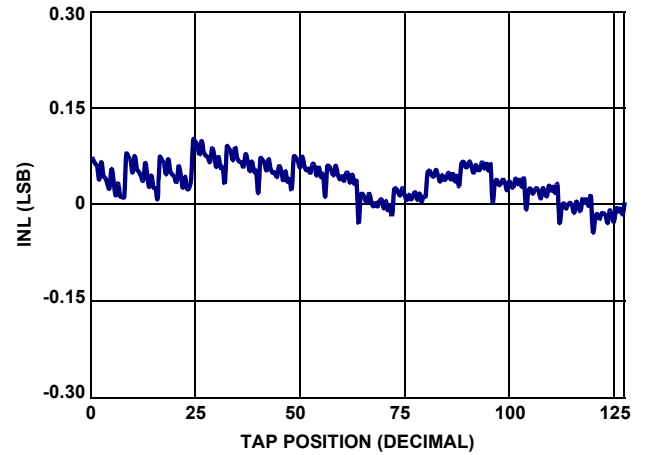

FIGURE 6. 50k INL vs TAP POSITION, $V_{CC} = 5V$

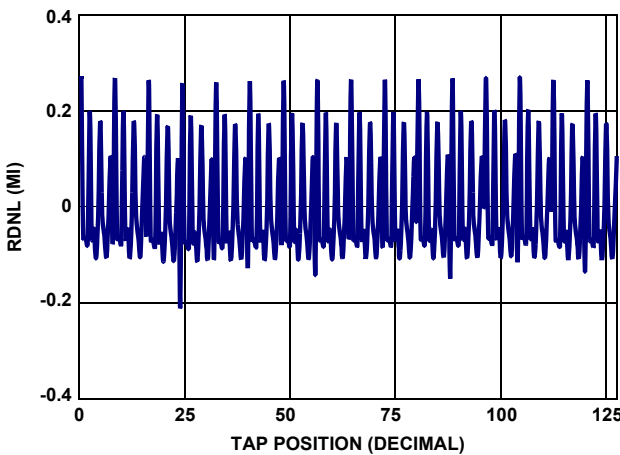

FIGURE 7. 10k RDNL vs TAP POSITION, $V_{CC} = 5V$

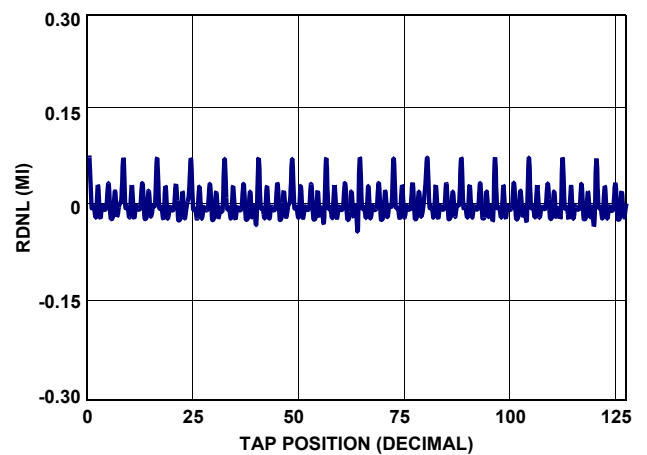

FIGURE 8. 50k RDNL vs TAP POSITION, $V_{CC} = 5V$

Typical Performance Curves (Continued)

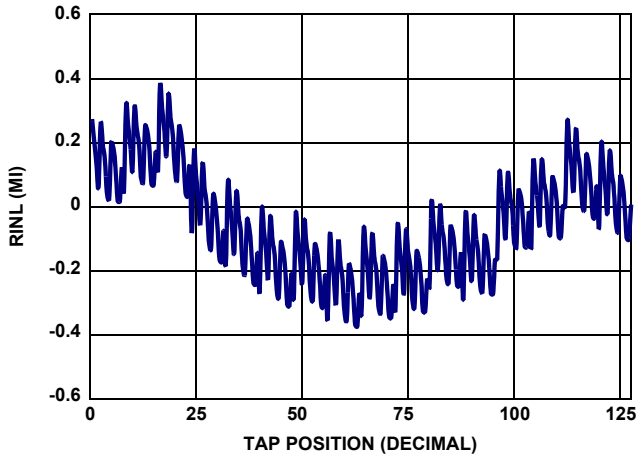

FIGURE 9. 10k RINL vs TAP POSITION, $V_{CC} = 5V$

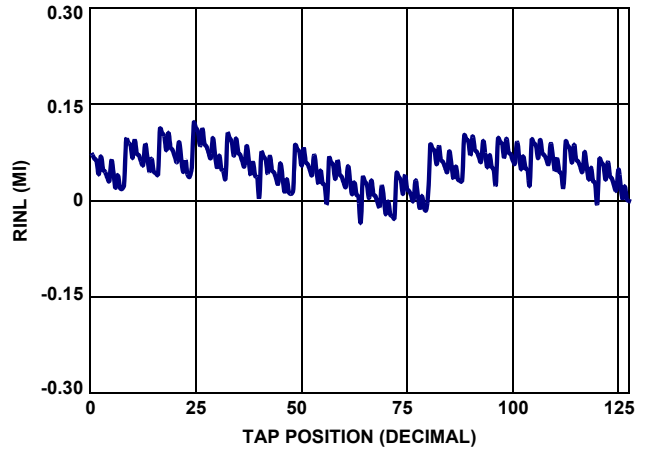

FIGURE 10. 50k RINL vs TAP POSITION, $V_{CC} = 5V$

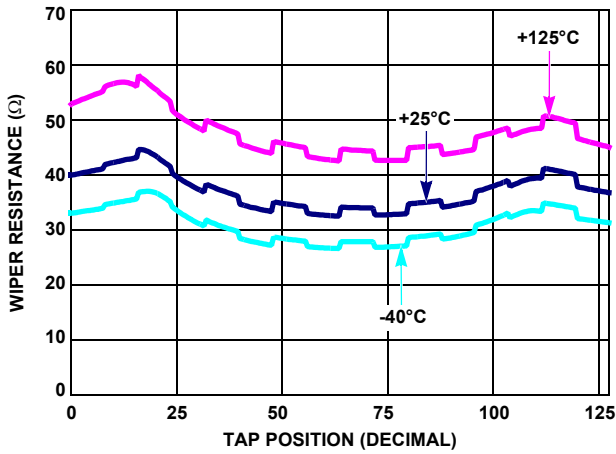

FIGURE 11. 10k WIPER RESISTANCE vs TAP POSITION, $V_{CC} = 5V$

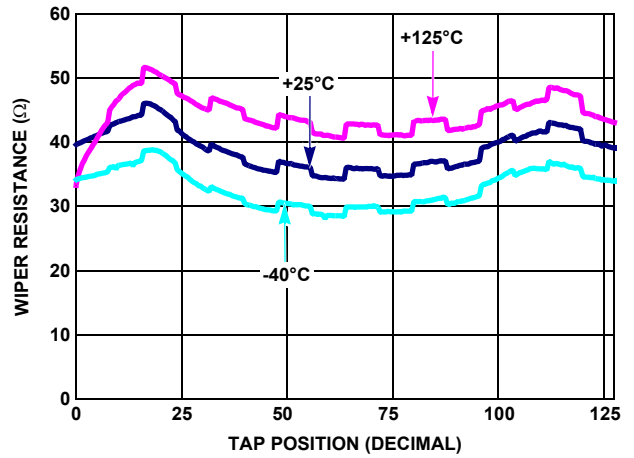

FIGURE 12. 50k WIPER RESISTANCE vs TAP POSITION, $V_{CC} = 5V$

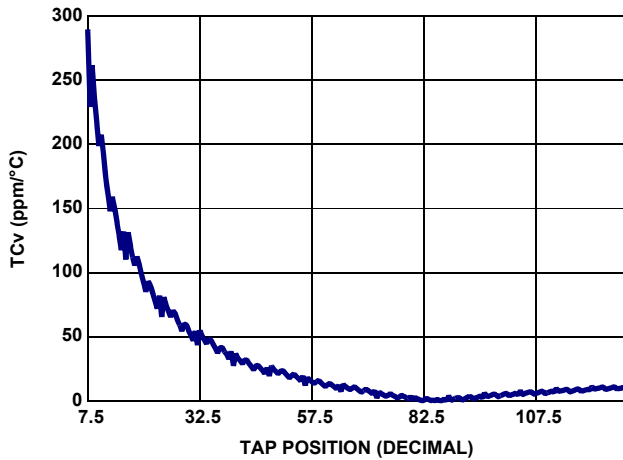

FIGURE 13. 10k TCv vs TAP POSITION

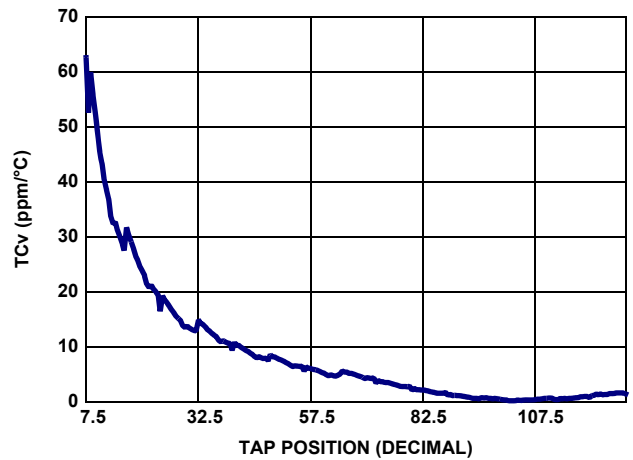

FIGURE 14. 50k TCv vs TAP POSITION

Typical Performance Curves (Continued)

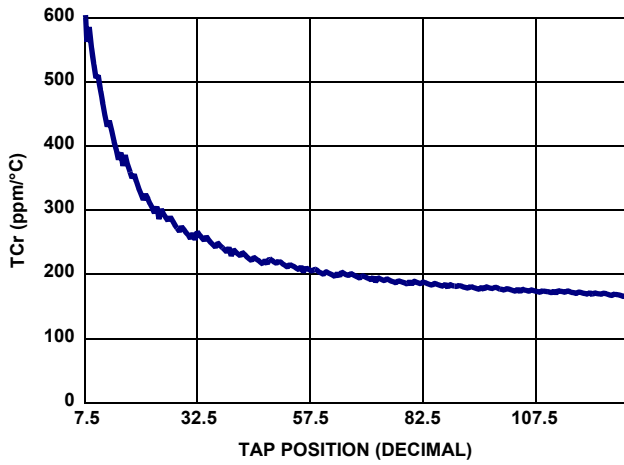

FIGURE 15. 10k TCr vs TAP POSITION

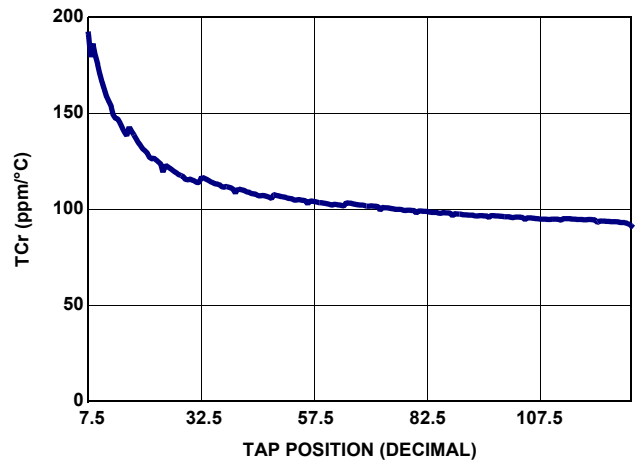

FIGURE 16. 50k TCr vs TAP POSITION

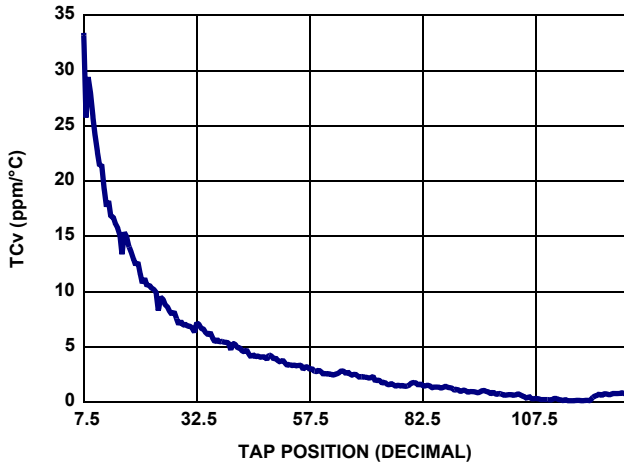

FIGURE 17. 100k TCv vs TAP POSITION

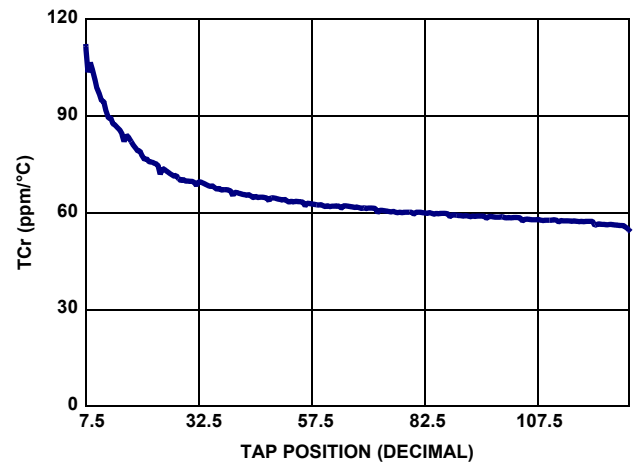

FIGURE 18. 100k TCr vs TAP POSITION

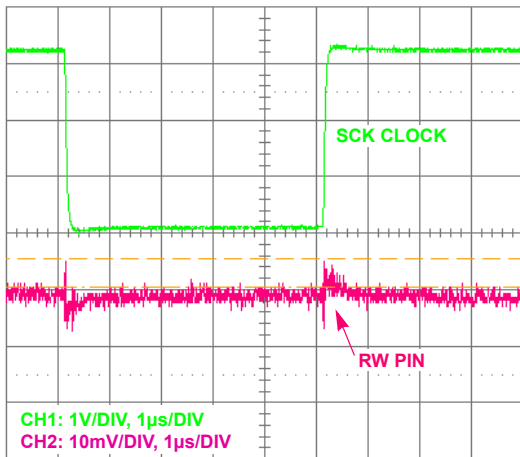

FIGURE 19. WIPER DIGITAL FEEDTHROUGH

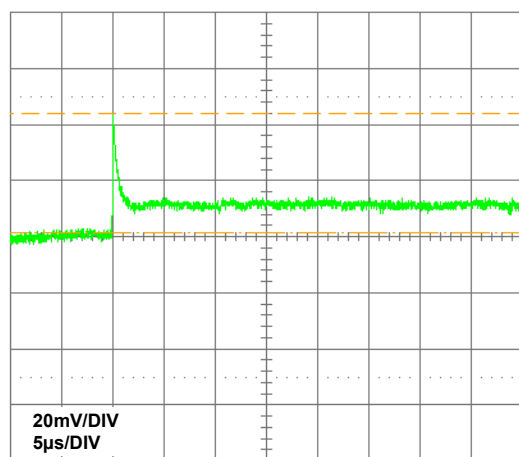

FIGURE 20. WIPER TRANSITION GLITCH

Typical Performance Curves (Continued)

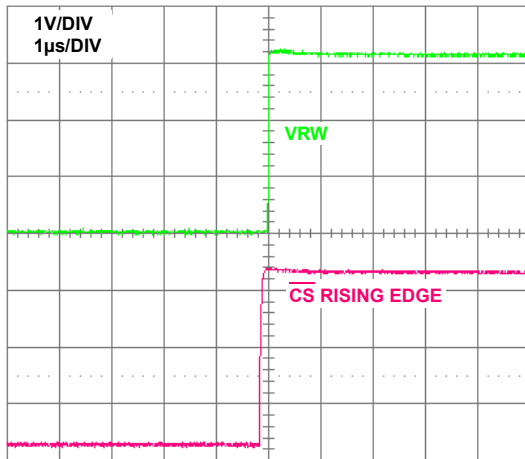

FIGURE 21. WIPER LARGE SIGNAL SETTLING TIME

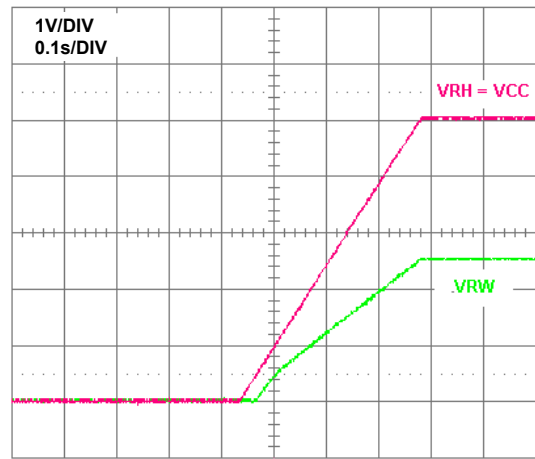

FIGURE 22. POWER-ON START-UP IN VOLTAGE DIVIDER MODE

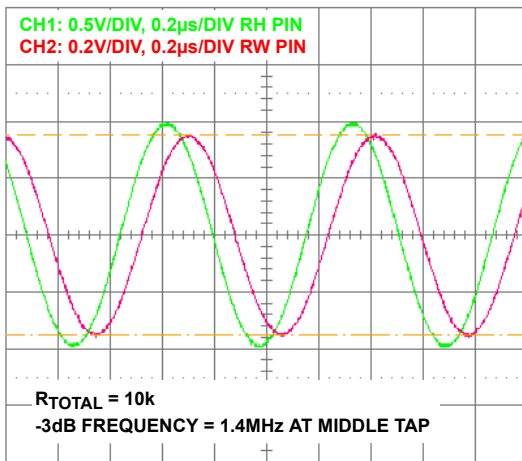

FIGURE 23. 10k -3dB CUT OFF FREQUENCY

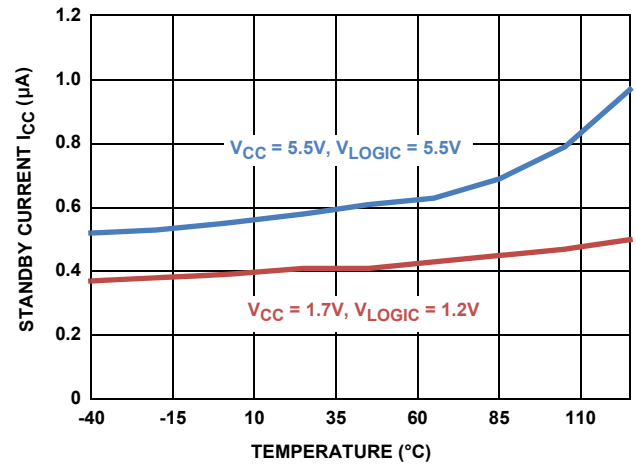

FIGURE 24. STANDBY CURRENT vs TEMPERATURE

Functional Pin Descriptions

Potentiometers Pins

RH AND RL

The high (RH) and low (RL) terminals of the ISL23418 are equivalent to the fixed terminals of a mechanical potentiometer. The RH and RL are referenced to the relative position of the wiper and not to the voltage potential on the terminals. With the WR register set to 127 decimal, the wiper is closest to RH, and with the WR register set to 0, the wiper is closest to RL.

RW

RW is the wiper terminal, and it is equivalent to the moveable terminal of a mechanical potentiometer. The position of the wiper within the array is determined by the WR register.

Bus Interface Pins

SERIAL CLOCK (SCK)

The SCK input is the serial clock of the SPI serial interface.

SERIAL DATA INPUT (SDI)

SDI is a serial data input pin for the SPI interface. SDI receives operation code, wiper address and data from the SPI remote host device. The data bits are shifted in at the rising edge of the serial clock, SCK, while \overline{CS} input is low.

SERIAL DATA OUTPUT (SDO)

SDO is a serial data output pin. During a read cycle, the data bits are shifted out on the falling edge of the serial clock SCK and are available to the master on the following rising edge of SCK.

The output type is configured through ACR[1] bit for Push-Pull or Open Drain operation. Default setting for this pin is Push-Pull. An external pull-up resistor is required for Open Drain output operation. When CS is HIGH, the SDO pin is in tri-state (Z) or high-tri-state (Hi-Z), depending on the selected configuration.

CHIP SELECT (\overline{CS})

\overline{CS} LOW enables the ISL23418, placing it in the active power mode. A HIGH to LOW transition on \overline{CS} is required prior to the start of any operation after power-up. When CS is HIGH, the ISL23418 is deselected, the SDO pin is at high impedance, and the device is in standby state.

VLOGIC

VLOGIC is an input pin that supplies an internal level translator for serial bus operation from 1.2V to 5.5V.

Principles of Operation

The ISL23418 is an integrated circuit incorporating one DCP with its associated registers and an SPI serial interface providing direct communication between a host and the potentiometer. The resistor array is composed of individual resistors connected in series. At either end of the array and between each resistor is an electronic switch that transfers the potential at that point to the wiper. The electronic switches on the device operate in a “make before break” mode when the wiper changes tap positions.

Voltage at any DCP pins, RH, RL, or RW should not exceed V_{CC} level at any conditions during power-up and normal operation. The VLOGIC pin must be connected to the SPI bus supply, which allows reliable communication with a wide range of microcontrollers, independently of the V_{CC} level. This is extremely important in systems in which the digital supply has lower levels than the analog supply.

DCP Description

Each DCP is implemented with a combination of resistor elements and CMOS switches. The physical ends of DCP are equivalent to the fixed terminals of a mechanical potentiometer (RH and RL pins). The RW pin of the DCP is connected to intermediate nodes and is equivalent to the wiper terminal of a mechanical potentiometer. The position of the wiper terminal within the DCP is controlled by the 8-bit volatile Wiper Register (WR). When the WR of a DCP contains all zeroes (WR[7:0] = 00h), its wiper terminal (RW) is closest to its “Low” terminal (RL). When the WR register of a DCP contains all ones (WR[7:0] = 7Fh), its wiper terminal (RW) is closest to its “High” terminal (RH). As the value of WR increases from all zeroes (0) to all ones (127 decimal), the wiper moves monotonically from the position closest to RL to the position closest to RH. At the same time, the resistance between RW and RL increases monotonically, while the resistance between RH and RW decreases monotonically.

While the ISL23418 is being powered up, the WR is reset to 40h (64 decimal), which locates RW to the mid value between RL and RH.

WR can be read or written to directly using the SPI serial interface as described in the following sections.

Memory Description

The ISL23418 contains two volatile 8-bit registers: the Wiper Register (WR) and the Access Control Register (ACR). A memory map of ISL23418 is shown in Table 1. WR, at address 0, contains the current wiper position of the DCP. ACR, at address 10h, contains information and control bits as described in Table 2.

TABLE 1. MEMORY MAP

ADDRESS (hex)	VOLATILE	DEFAULT SETTING (hex)
10	ACR	40
0	WR	80

TABLE 2. ACCESS CONTROL REGISTER (ACR)

BIT #	7	6	5	4	3	2	1	0
NAME	0	\overline{SHDN}	0	0	0	0	SDO	0

Shutdown Function

The \overline{SHDN} bit (ACR[6]) disables or enables shutdown mode for all DCP channels simultaneously. When this bit is 0, DCP is forced to end-to-end open circuit, and RW is connected to RL through a 2k Ω serial resistor, as shown in Figure 25. Default value of the \overline{SHDN} bit is 1.

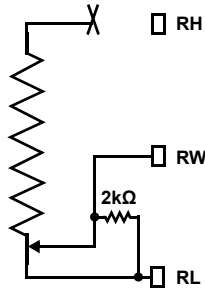

FIGURE 25. DCP CONNECTION IN SHUTDOWN MODE

In shutdown mode, the RW terminal is shorted to the RL terminal with around 2kΩ resistance, as shown in Figure 25. When the device enters shutdown, all current DCP WR settings are maintained. When the device exits shutdown, the wipers return to the previous WR settings after a short settling time (Figure 26).

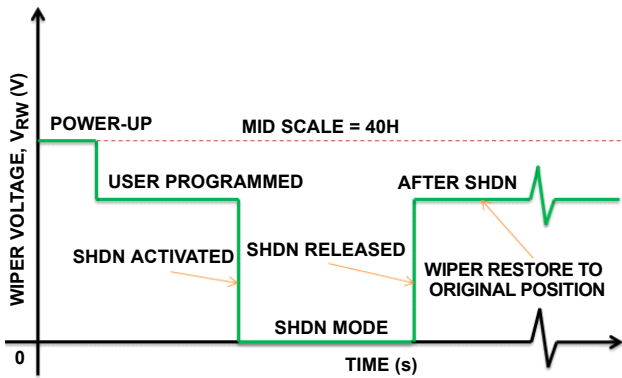

FIGURE 26. SHUTDOWN MODE WIPER RESPONSE

In shutdown mode, if there is a glitch in the power supply that causes it to drop below 1.3V for more than 0.2μs to 0.4μs, the wipers are RESET to their mid position. This is done to avoid an undefined state at the wiper outputs.

SPI Serial Interface

The ISL23418 supports an SPI serial protocol, mode 0. The device is accessed via the SDI input and SDO output, with data clocked in on the rising edge of SCK and clocked out on the falling edge of SCK. \overline{CS} must be LOW during communication with the ISL23418. The SCK and \overline{CS} lines are controlled by the host or master. The ISL23418 operates only as a slave device. All communication over the SPI interface is conducted by sending the MSB of each byte of data first.

Protocol Conventions

The SPI protocol contains an Instruction Byte followed by one or more Data Bytes. A valid Instruction Byte contains instruction as the three MSBs, with the following five register address bits (Table 3). The next byte sent to the ISL23418 is the Data Byte.

TABLE 3. INSTRUCTION BYTE FORMAT

BIT #	7	6	5	4	3	2	1	0
	I2	I1	I0	R4	R3	R2	R1	R0

Table 4 contains a valid instruction set for ISL23418. If the [R4:R0] bits are zero, then the read or write is to the WR register. If the [R4:R0] bits are 10000, then the operation is to the ACR.

Write Operation

A write operation to the ISL23418 is a two or more bytes operation. It first requires \overline{CS} to transition from HIGH to LOW. Then the host sends a valid Instruction Byte to the SDI pin, followed by one or more Data Bytes. The host terminates the write operation by pulling the \overline{CS} pin from LOW to HIGH. The instruction is executed on the rising edge of \overline{CS} (Figure 27).

Read Operation

A read operation to the ISL23418 is a four-byte operation. First, the \overline{CS} transitions from HIGH to LOW. Then the host sends a valid Instruction Byte to the SDI pin, followed by a “dummy” Data Byte, an NOP Instruction Byte, and another “dummy” Data Byte. The SPI host receives the Instruction Byte (instruction code + register address) and the requested Data Byte from the SDO pin on the rising edge of SCK during the third and fourth bytes, respectively. The host terminates the read by pulling the \overline{CS} pin from LOW to HIGH (Figure 28).

TABLE 4. INSTRUCTION SET

INSTRUCTION SET								OPERATION
I2	I1	I0	R4	R3	R2	R1	R0	
0	0	0	X	X	X	X	X	NOP
0	0	1	X	X	X	X	X	ACR READ
0	1	1	X	X	X	X	X	ACR WRTE
1	0	0	R4	R3	R2	R1	R0	WR or ACR READ
1	1	0	R4	R3	R2	R1	R0	WR or ACR WRTE

where “X” means “do not care.”

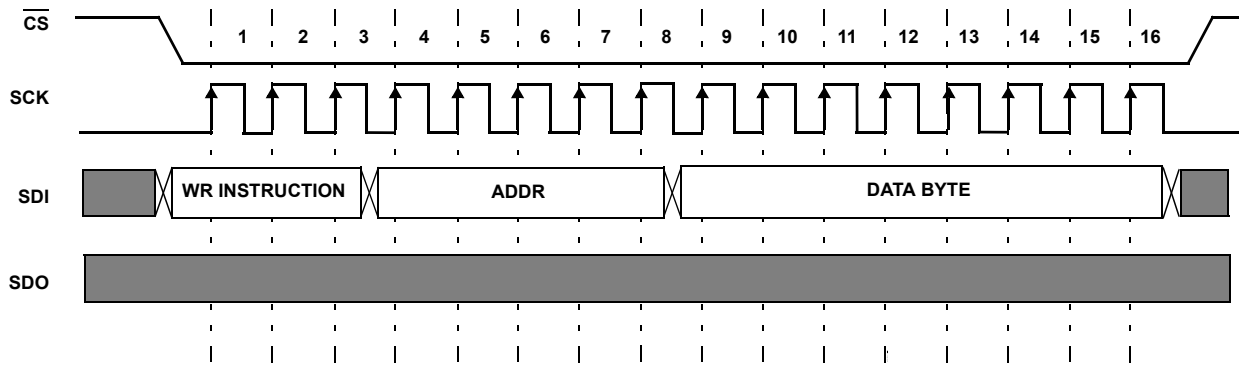

FIGURE 27. TWO-BYTE WRITE SEQUENCE

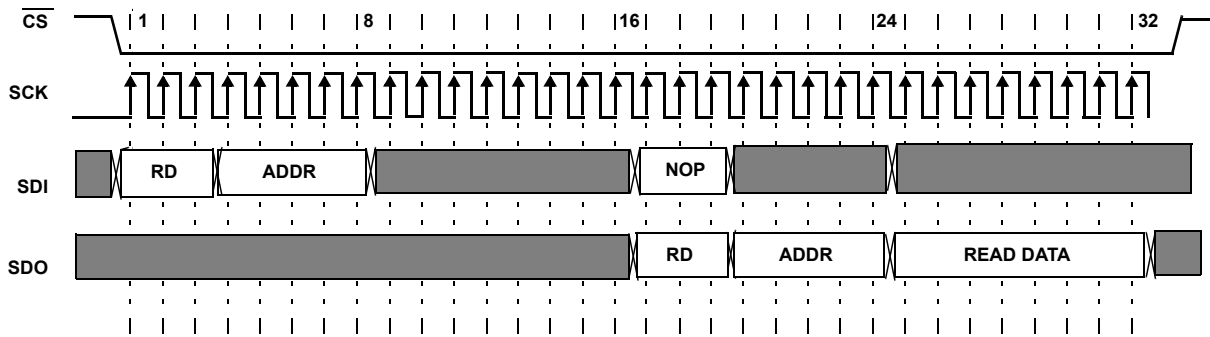

FIGURE 28. FOUR-BYTE READ SEQUENCE

Applications Information

Communicating with ISL23418

Communication with ISL23418 is accomplished by using the SPI interface through the ACR (address 10000b) and WR (address 00000b) registers.

The wiper of the potentiometer is controlled by the WR register. Writes and reads can be made directly to these registers to control and monitor the wiper position.

Daisy Chain Configuration

When an application needs more than one ISL23418, it can communicate with all of them without additional \overline{CS} lines by daisy chaining the DCPs, as shown in Figure 29. In daisy chain configuration, the SDO pin of the previous chip is connected to the SDI pin of the following chip, and each \overline{CS} and SCK pin is connected to the corresponding microcontroller pin in parallel, like regular SPI interface implementation. The daisy chain configuration can also be used for simultaneous setting of multiple DCPs. Note that the number of daisy chained DCPs is limited only by the driving capabilities of the SCK and \overline{CS} pins of the microcontroller. For a larger number of SPI devices, buffering of the SCK and \overline{CS} lines is required.

Daisy Chain Write Operation

The write operation starts with a HIGH to LOW transition on the \overline{CS} line, followed by N number of two-byte write instructions on the SDI line, with reversed chain access sequence. The instruction byte + data byte for the last DCP in the chain go first, as shown in Figure 30, where N is the number of DCPs in the chain. Serial data is going through the DCPs from DCP0 to DCP(N-1) as follows: DCP0 → DCP1 → DCP2 → ... → DCP(N-1). The write instruction is executed on the rising edge of \overline{CS} for all N DCPs simultaneously.

Daisy Chain Read Operation

The read operation consists of two parts. First, the read instructions (N two-byte operations) are sent with a valid address. Second, the requested data is read while sending NOP instructions (N two-byte operations), as shown in Figures 31 and 32.

First there is a HIGH-to-LOW transition on the \overline{CS} line, followed by N two-byte read instructions on the SDI line, with reversed chain access sequence. The instruction byte + dummy data byte for the last DCP in the chain goes first, followed by a LOW-to-HIGH transition on the \overline{CS} line. The read instructions are executed during the second part of the read sequence. It also starts by a HIGH-to-LOW transition on the \overline{CS} line, followed by N number of two-byte NOP instructions on the SDI line and a LOW-to-HIGH transition of \overline{CS} . The data is read on every even byte during the second part of the read sequence, while every odd byte contains code 111b followed by the address from which the data is being read.

Wiper Transition

When stepping up through each tap in voltage divider mode, some tap transition points can exhibit noticeable voltage transients or overshoot/undershoot, which results from the sudden transition from a very low impedance “make” to a much higher impedance “break” within a short period of time (<1 μ s). Several code transitions, such as 0Fh to 10h, 1Fh to 20h, ..., and EFh to 7Fh, have higher transient glitch. Note that all switching transients settle well within the settling time as stated in the datasheet. A small capacitor can be added externally to reduce the amplitude of these voltage transients, but this also reduces the useful bandwidth of the circuit, which may not be a good solution for some applications. Using fast amplifiers in a signal chain for fast recovery may be a good idea in these cases.

V_{LOGIC} Requirements

Keeping V_{LOGIC} powered all the time during normal operation is recommended. In cases in which turning V_{LOGIC} OFF is necessary, grounding the V_{LOGIC} pin is recommended. Grounding the V_{LOGIC} pin or both V_{LOGIC} and V_{CC} does not affect other devices on the same bus. It is good practice to put a 1 μ F capacitor in parallel with a 0.1 μ F decoupling capacitor close to the V_{LOGIC} pin.

V_{CC} Requirements and Placement

Putting a 1 μ F capacitor in parallel with a 0.1 μ F decoupling capacitor close to the V_{CC} pin is recommended.

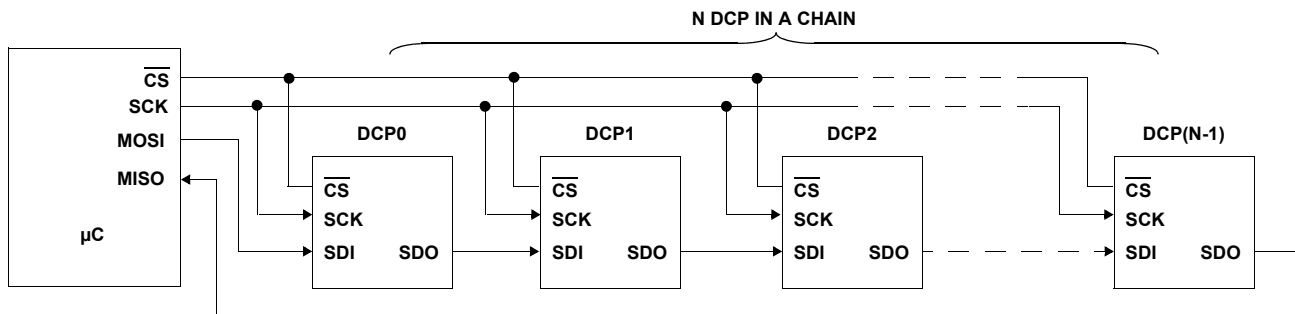

FIGURE 29. DAISY CHAIN CONFIGURATION

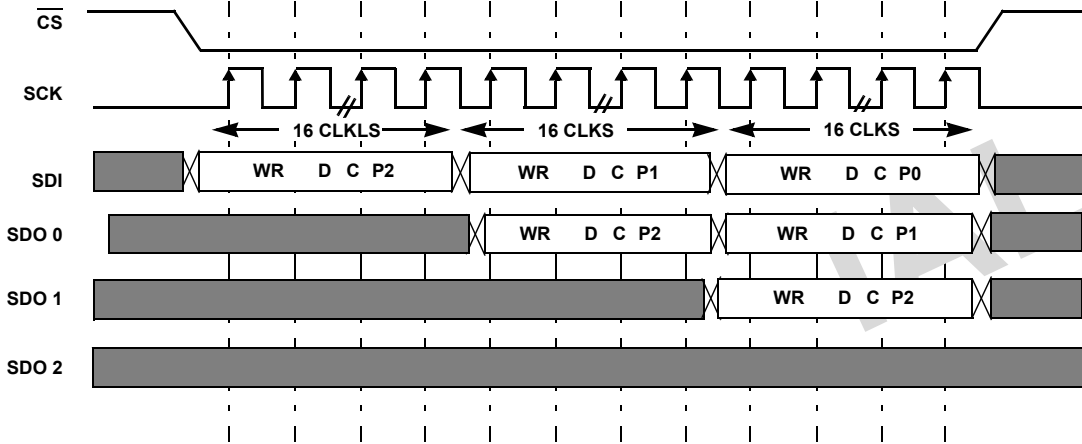

FIGURE 30. DAISY CHAIN WRITE SEQUENCE OF N = 3 DCP

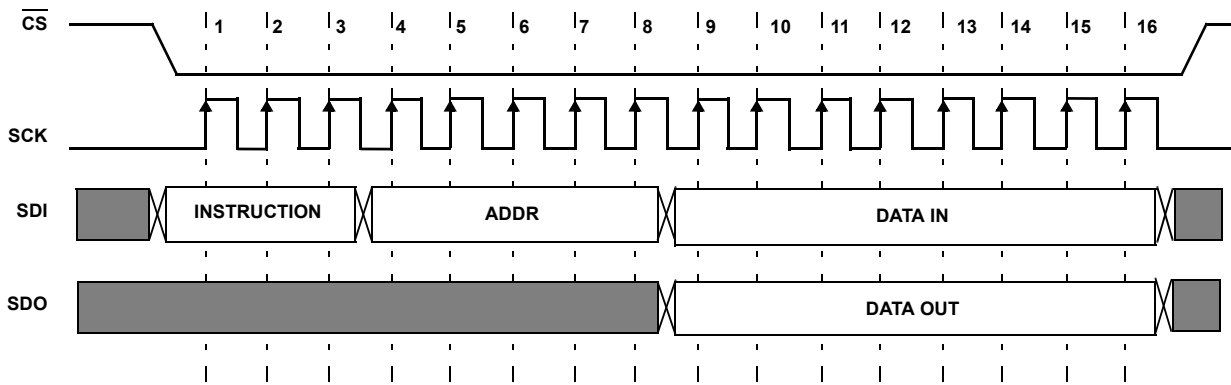

FIGURE 31. TWO-BYTE READ INSTRUCTION

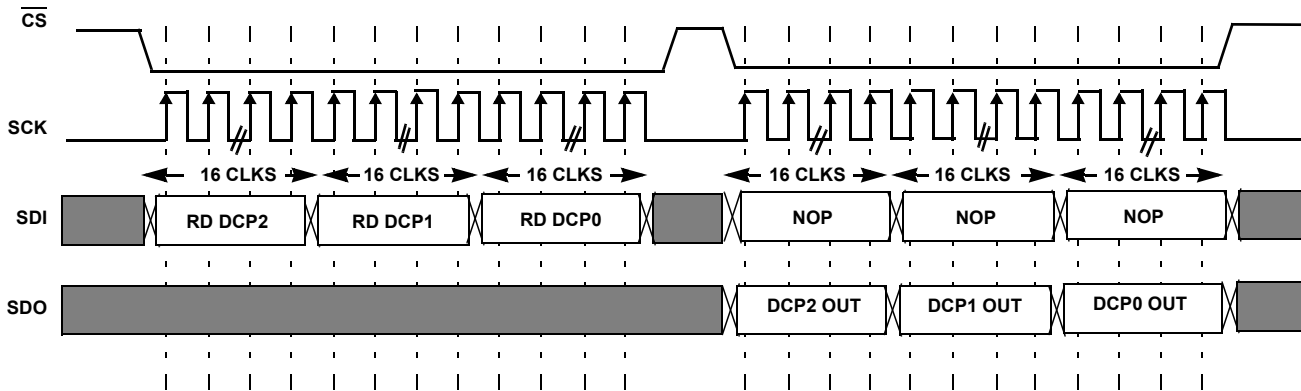

FIGURE 32. DAISY CHAIN READ SEQUENCE OF N = 3 DCP

Revision History

The revision history provided is for informational purposes only and is believed to be accurate, but not warranted. Please go to web to make sure you have the latest revision.

DATE	REVISION	CHANGE
September 24, 2015	FN7901.1	Updated the Ordering Information table on page 3. Replaced Products section with About Intersil section. Updated Package Outline Drawing M10.118 to the latest revision. Changes are as follows: -Updated to new POD template. Added land pattern
August 3, 2011	FN7901.0	Initial Release

About Intersil

Intersil Corporation is a leading provider of innovative power management and precision analog solutions. The company's products address some of the largest markets within the industrial and infrastructure, mobile computing and high-end consumer markets.

For the most updated datasheet, application notes, related documentation and related parts, please see the respective product information page found at www.intersil.com.

You may report errors or suggestions for improving this datasheet by visiting www.intersil.com/ask.

Reliability reports are also available from our website at www.intersil.com/support.

© Copyright Intersil Americas LLC 2011-2015. All Rights Reserved.
All trademarks and registered trademarks are the property of their respective owners.

For additional products, see www.intersil.com/en/products.html

Intersil products are manufactured, assembled and tested utilizing ISO9001 quality systems as noted in the quality certifications found at www.intersil.com/en/support/qualandreliability.html

Intersil products are sold by description only. Intersil may modify the circuit design and/or specifications of products at any time without notice, provided that such modification does not, in Intersil's sole judgment, affect the form, fit or function of the product. Accordingly, the reader is cautioned to verify that datasheets are current before placing orders. Information furnished by Intersil is believed to be accurate and reliable. However, no responsibility is assumed by Intersil or its subsidiaries for its use; nor for any infringements of patents or other rights of third parties which may result from its use. No license is granted by implication or otherwise under any patent or patent rights of Intersil or its subsidiaries.

For information regarding Intersil Corporation and its products, see www.intersil.com

Package Outline Drawing

M10.118

10 LEAD MINI SMALL OUTLINE PLASTIC PACKAGE

Rev 1, 4/12

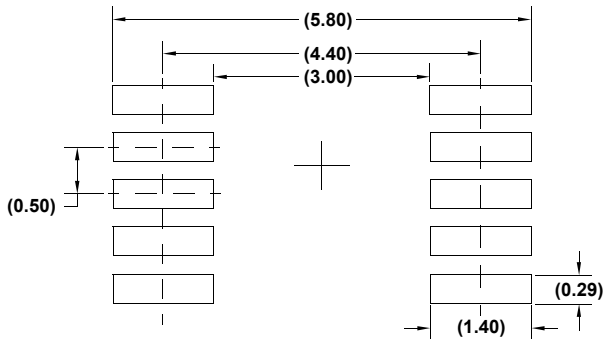
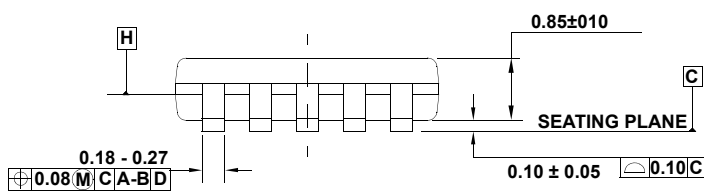
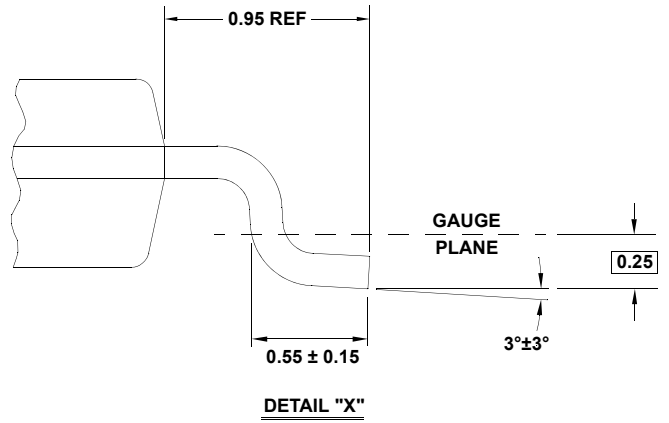
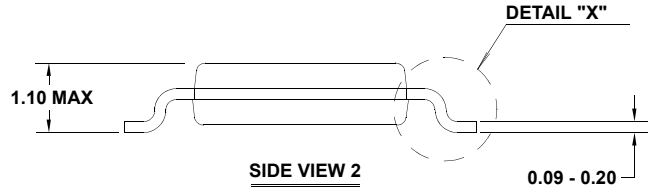
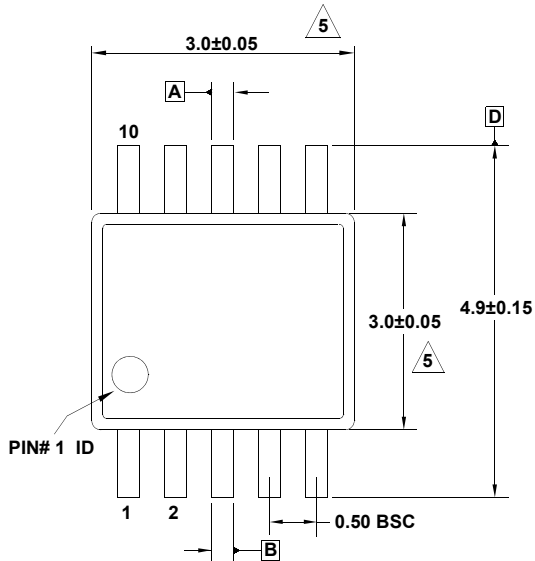

NOTES:

1. Dimensions are in millimeters.
2. Dimensioning and tolerancing conform to JEDEC MO-187-BA and AMSEY14.5m-1994.
3. Plastic or metal protrusions of 0.15mm max per side are not included.
4. Plastic interlead protrusions of 0.15mm max per side are not included.
5. Dimensions are measured at Datum Plane "H".
6. Dimensions in () are for reference only.

Package Outline Drawing

L10.2.1x1.6A

10 LEAD ULTRA THIN QUAD FLAT NO-LEAD PLASTIC PACKAGE

Rev 5, 3/10

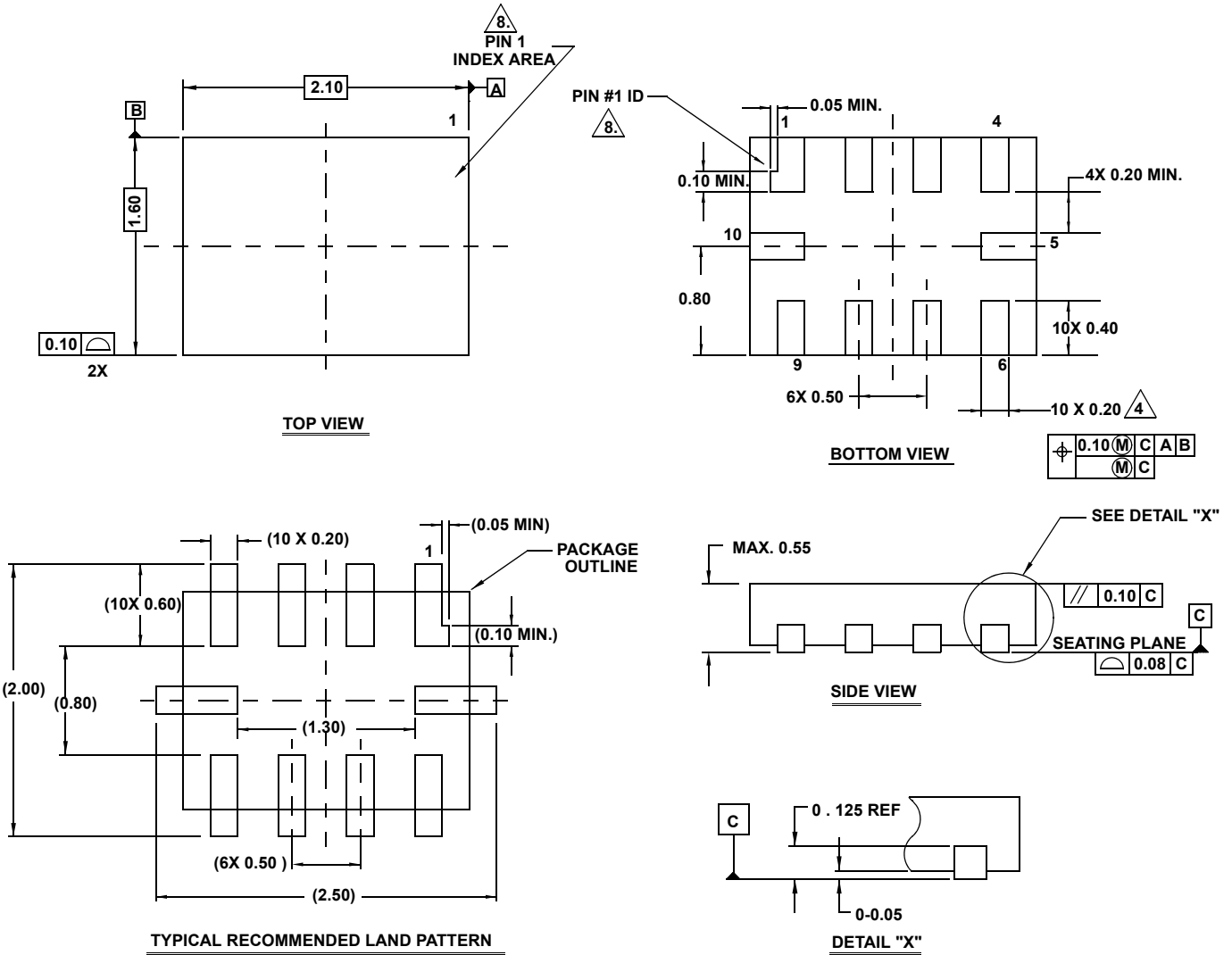

NOTES:

1. Dimensioning and tolerancing conform to ASME Y14.5M-1994.
2. All Dimensions are in millimeters. Angles are in degrees. Dimensions in () for Reference Only.
3. Unless otherwise specified, tolerance : Decimal ± 0.05
4. Lead width dimension applies to the metallized terminal and is measured between 0.15mm and 0.30mm from the terminal tip.
5. Maximum package warpage is 0.05mm.
6. Maximum allowable burrs is 0.076mm in all directions.
7. Same as JEDEC MO-255UABD except:
No lead-pull-back, MIN. Package thickness = 0.45 not 0.50mm
Lead Length dim. = 0.45mm max. not 0.42mm.
8. The configuration of the pin #1 identifier is optional, but must be located within the zone indicated. The pin #1 identifier may be either a mold or mark feature.