

## AD5200/AD5201

### FEATURES

**AD5200—256-Position**

**AD5201—33-Position**

**10 k $\Omega$ , 50 k $\Omega$**

**3-Wire SPI-Compatible Serial Data Input**

**Single Supply 2.7 V to 5.5 V or**

**Dual Supply  $\pm 2.7$  V for AC or Bipolar Operations**

**Internal Power-On Midscale Preset**

### APPLICATIONS

**Mechanical Potentiometer Replacement**

**Instrumentation: Gain, Offset Adjustment**

**Programmable Voltage-to-Current Conversion**

**Programmable Filters, Delays, Time Constants**

**Line Impedance Matching**

### GENERAL DESCRIPTION

The AD5200 and AD5201 are programmable resistor devices, with 256 positions and 33 positions respectively, that can be digitally controlled through a 3-wire SPI serial interface. The terms programmable resistor, variable resistor (VR), and RDAC are commonly used interchangeably to refer to digital potentiometers. These devices perform the same electronic adjustment function as a potentiometer or variable resistor. Both AD5200/AD5201 contain a single variable resistor in the compact  $\mu$ SOIC-10 package. Each device contains a fixed wiper resistance at the wiper contact that taps the programmable resistance at a point determined by a digital code. The code is loaded in the serial input register. The resistance between the wiper and either end point of the programmable resistor varies linearly with respect to the digital code transferred into the VR latch. Each variable resistor offers a completely programmable value of resistance, between the A terminal and the wiper, or the B terminal and the wiper. The fixed A-to-B terminal resistance of 10 k $\Omega$  or 50 k $\Omega$

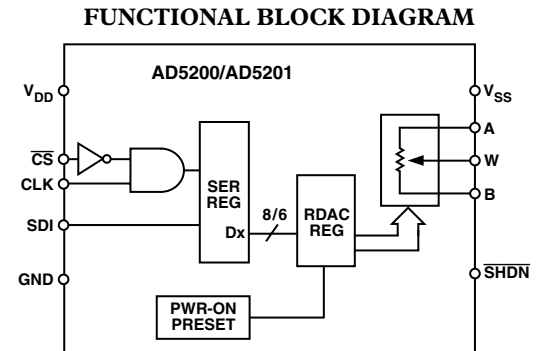

has a nominal temperature coefficient of 500 ppm/ $^{\circ}$ C. The VR has a VR latch that holds its programmed resistance value. The VR latch is updated from an SPI-compatible serial-to-parallel shift register that is loaded from a standard 3-wire serial-input digital interface. Eight data bits for the AD5200 and six data bits for the AD5201 make up the data word that is clocked into the serial input register. The internal preset forces the wiper to the midscale position by loading 80<sub>H</sub> and 10<sub>H</sub> into AD5200 and AD5201 VR latches respectively. The  $\overline{\text{SHDN}}$  pin forces the resistor to an end-to-end open-circuit condition on the A terminal and shorts the wiper to the B terminal, achieving a microwatt power shutdown state. When  $\overline{\text{SHDN}}$  is returned to logic high, the previous latch setting puts the wiper in the same resistance setting prior to shutdown. The digital interface is still active during shutdown so that code changes can be made that will produce a new wiper position when the device is returned from shutdown.

All parts are guaranteed to operate over the extended industrial temperature range of  $-40^{\circ}$ C to  $+85^{\circ}$ C.

REV. B

Information furnished by Analog Devices is believed to be accurate and reliable. However, no responsibility is assumed by Analog Devices for its use, nor for any infringements of patents or other rights of third parties that may result from its use. No license is granted by implication or otherwise under any patent or patent rights of Analog Devices.

# AD5200/AD5201—SPECIFICATIONS

## AD5200 ELECTRICAL CHARACTERISTICS ( $V_{DD} = 5\text{ V} \pm 10\%$ , or $3\text{ V} \pm 10\%$ , $V_{SS} = 0\text{ V}$ , $V_A = +V_{DD}$ , $V_B = 0\text{ V}$ , $-40^\circ\text{C} < T_A < +85^\circ\text{C}$ unless otherwise noted.)

Parameter	Symbol	Conditions	Min	Typ <sup>1</sup>	Max	Unit
<b>DC CHARACTERISTICS RHEOSTAT MODE</b>						
Resistor Differential Nonlinearity <sup>2</sup>	R-DNL	$R_{WB}$ , $V_A = \text{No Connect}$	-1	$\pm 0.25$	+1	LSB
Resistor Integral Nonlinearity <sup>2</sup>	R-INL	$R_{WB}$ , $V_A = \text{No Connect}$	-2	$\pm 0.5$	+2	LSB
Nominal Resistor Tolerance <sup>3</sup>	$\Delta R_{AB}$	$T_A = 25^\circ\text{C}$	-30		+30	%
Resistance Temperature Coefficient	$R_{AB}/\Delta T$	$V_{AB} = V_{DD}$ , Wiper = No Connect		500		ppm/ $^\circ\text{C}$
Wiper Resistance	$R_W$	$V_{DD} = 5\text{ V}$		50	100	$\Omega$
<b>DC CHARACTERISTICS POTENTIOMETER DIVIDER MODE (Specifications apply to all VRs.)</b>						
Resolution	N		8			Bits
Differential Nonlinearity <sup>4</sup>	DNL		-1	$\pm 1/4$	+1	LSB
Integral Nonlinearity <sup>4</sup>	INL		-2	$\pm 1/2$	+2	LSB
Voltage Divider Temperature Coefficient	$\Delta V_W/\Delta T$	Code = 80 <sub>H</sub>		5		ppm/ $^\circ\text{C}$
Full-Scale Error	$V_{WFSE}$	Code = FF <sub>H</sub>	-1.5	-0.5	0	LSB
Zero-Scale Error	$V_{WZSE}$	Code = 00 <sub>H</sub>	0	+0.5	+1.5	LSB
<b>RESISTOR TERMINALS</b>						
Voltage Range <sup>5</sup>	$V_{A, B, W}$		$V_{SS}$		$V_{DD}$	V
Capacitance <sup>6</sup> A, B	$C_{A, B}$	$f = 1\text{ MHz}$ , Measured to GND, Code = 80 <sub>H</sub>		45		pF
Capacitance <sup>6</sup> W	$C_W$	$f = 1\text{ MHz}$ , Measured to GND, Code = 80 <sub>H</sub>		60		pF
Shutdown Supply Current <sup>7</sup>	$I_{DD\_SD}$	$V_{DD} = 5.5\text{ V}$		0.01	5	$\mu\text{A}$
Common-Mode Leakage	$I_{CM}$	$V_A = V_B = V_{DD}/2$		1		nA
<b>DIGITAL INPUTS AND OUTPUTS</b>						
Input Logic High	$V_{IH}$		2.4			V
Input Logic Low	$V_{IL}$				0.8	V
Input Logic High	$V_{IH}$	$V_{DD} = 3\text{ V}$ , $V_{SS} = 0\text{ V}$	2.1			V
Input Logic Low	$V_{IL}$	$V_{DD} = 3\text{ V}$ , $V_{SS} = 0\text{ V}$			0.6	V
Input Current	$I_{IL}$	$V_{IN} = 0\text{ V}$ or $5\text{ V}$			$\pm 1$	$\mu\text{A}$
Input Capacitance <sup>6</sup>	$C_{IL}$			5		pF
<b>POWER SUPPLIES</b>						
Logic Supply	$V_{LOGIC}$		2.7		5.5	V
Power Single-Supply Range	$V_{DD\text{ RANGE}}$	$V_{SS} = 0\text{ V}$	-0.3		5.5	V
Power Dual-Supply Range	$V_{DD/SS\text{ RANGE}}$		$\pm 2.3$		$\pm 2.7$	V
Positive Supply Current	$I_{DD}$	$V_{IH} = +5\text{ V}$ or $V_{IL} = 0\text{ V}$		15	40	$\mu\text{A}$
Negative Supply Current	$I_{SS}$	$V_{SS} = -5\text{ V}$		15	40	$\mu\text{A}$
Power Dissipation <sup>8</sup>	$P_{DISS}$	$V_{IH} = +5\text{ V}$ or $V_{IL} = 0\text{ V}$ , $V_{DD} = +5\text{ V}$ , $V_{SS} = 0\text{ V}$			0.2	mW
Power Supply Sensitivity	PSS	$\Delta V_{DD} = +5\text{ V} \pm 10\%$ , Code = Midscale	-0.01	0.001	+0.01	%/%
<b>DYNAMIC CHARACTERISTICS <sup>6,9</sup></b>						
Bandwidth -3 dB	BW <sub>10 k<math>\Omega</math></sub>	$R_{AB} = 10\text{ k}\Omega$ , Code = 80 <sub>H</sub>		600		kHz
	BW <sub>50 k<math>\Omega</math></sub>	$R_{AB} = 50\text{ k}\Omega$ , Code = 80 <sub>H</sub>		100		kHz
Total Harmonic Distortion	THD <sub>W</sub>	$V_A = 1\text{ V rms}$ , $V_B = 0\text{ V}$ , $f = 1\text{ kHz}$ , $R_{AB} = 10\text{ k}\Omega$		0.003		%
$V_W$ Settling Time (10 k $\Omega$ /50 k $\Omega$ )	$t_S$	$V_A = 5\text{ V}$ , $V_B = 0\text{ V}$ , $\pm 1\text{ LSB Error Band}$		2/9		$\mu\text{s}$
Resistor Noise Voltage Density	$e_{N\_WB}$	$R_{WB} = 5\text{ k}\Omega$ , $R_S = 0$		9		$\text{nV}\sqrt{\text{Hz}}$

### NOTES

<sup>1</sup>Typicals represent average readings at  $25^\circ\text{C}$  and  $V_{DD} = 5\text{ V}$ ,  $V_{SS} = 0\text{ V}$ .

<sup>2</sup>Resistor position nonlinearity error R-INL is the deviation from an ideal value measured between the maximum resistance and the minimum resistance wiper positions. R-DNL measures the relative step change from ideal between successive tap positions. Parts are guaranteed monotonic.  $I_W = V_{DD}/R$  for both  $V_{DD} = +2.7\text{ V}$ ,  $V_{SS} = -2.7\text{ V}$ .

<sup>3</sup> $V_{AB} = V_{DD}$ , Wiper ( $V_W$ ) = No connect.

<sup>4</sup>INL and DNL are measured at  $V_W$  with the RDAC configured as a potentiometer divider similar to a voltage output D/A converter.  $V_A = V_{DD}$  and  $V_B = 0\text{ V}$ . DNL specification limits of  $\pm 1\text{ LSB}$  maximum are Guaranteed Monotonic operating conditions.

<sup>5</sup>Resistor Terminals A, B, W have no limitations on polarity with respect to each other.

<sup>6</sup>Guaranteed by design and not subject to production test.

<sup>7</sup>Measured at the A terminal. A terminal is open-circuited in shutdown mode.

<sup>8</sup> $P_{DISS}$  is calculated from  $(I_{DD} \times V_{DD})$ . CMOS logic level inputs result in minimum power dissipation.

<sup>9</sup>All dynamic characteristics use  $V_{DD} = 5\text{ V}$ ,  $V_{SS} = 0\text{ V}$ .

Specifications subject to change without notice.

# AD5201 ELECTRICAL CHARACTERISTICS

( $V_{DD} = 5\text{ V} \pm 10\%$ , or  $3\text{ V} \pm 10\%$ ,  $V_{SS} = 0\text{ V}$ ,  $V_A = +V_{DD}$ ,  $V_B = 0\text{ V}$ ,  $-40^\circ\text{C} < T_A < +85^\circ\text{C}$  unless otherwise noted.)

Parameter	Symbol	Conditions	Min	Typ <sup>1</sup>	Max	Unit
<b>DC CHARACTERISTICS RHEOSTAT MODE</b>						
Resistor Differential Nonlinearity <sup>2</sup>	R-DNL	$R_{WB}$ , $V_A = \text{No Connect}$	-0.5	$\pm 0.05$	+0.5	LSB
Resistor Integral Nonlinearity <sup>2</sup>	R-INL	$R_{WB}$ , $V_A = \text{No Connect}$	-1	$\pm 0.1$	+1	LSB
Nominal Resistor Tolerance <sup>3</sup>	$\Delta R_{AB}$	$T_A = 25^\circ\text{C}$	-30		+30	%
Resistance Temperature Coefficient	$R_{AB}/\Delta T$	$V_{AB} = V_{DD}$ , Wiper = No Connect		500		ppm/ $^\circ\text{C}$
Wiper Resistance	$R_W$	$V_{DD} = 5\text{ V}$		50	100	$\Omega$
<b>DC CHARACTERISTICS POTENTIOMETER DIVIDER MODE (Specifications apply to all VRs.)</b>						
Resolution <sup>4</sup>	N		6			Bits
Differential Nonlinearity <sup>5</sup>	DNL		-0.5	$\pm 0.01$	+0.5	LSB
Integral Nonlinearity <sup>5</sup>	INL		-1	$\pm 0.02$	+1	LSB
Voltage Divider Temperature Coefficient	$\Delta V_W/\Delta T$	Code = 10 <sub>H</sub>		5		ppm/ $^\circ\text{C}$
Full-Scale Error	$V_{WFSE}$	Code = 20 <sub>H</sub>	-1/2	-1/4	0	LSB
Zero-Scale Error	$V_{WZSE}$	Code = 00 <sub>H</sub>	0	+1/4	+1/2	LSB
<b>RESISTOR TERMINALS</b>						
Voltage Range <sup>6</sup>	$V_{A, B, W}$		$V_{SS}$		$V_{DD}$	V
Capacitance <sup>7</sup> A, B	$C_{A, B}$	$f = 1\text{ MHz}$ , Measured to GND, Code = 10 <sub>H</sub>		45		pF
Capacitance <sup>7</sup> W	$C_W$	$f = 1\text{ MHz}$ , Measured to GND, Code = 10 <sub>H</sub>		60		pF
Shutdown Supply Current <sup>8</sup>	$I_{DD\_SD}$	$V_{DD} = 5.5\text{ V}$		0.01	5	$\mu\text{A}$
Common-Mode Leakage	$I_{CM}$	$V_A = V_B = V_{DD}/2$		1		nA
<b>DIGITAL INPUTS AND OUTPUTS</b>						
Input Logic High	$V_{IH}$		2.4			V
Input Logic Low	$V_{IL}$				0.8	V
Input Logic High	$V_{IH}$	$V_{DD} = 3\text{ V}$ , $V_{SS} = 0\text{ V}$	2.1			V
Input Logic Low	$V_{IL}$	$V_{DD} = 3\text{ V}$ , $V_{SS} = 0\text{ V}$			0.6	V
Input Current	$I_{IL}$	$V_{IN} = 0\text{ V}$ or $5\text{ V}$			$\pm 1$	$\mu\text{A}$
Input Capacitance <sup>7</sup>	$C_{IL}$			5		pF
<b>POWER SUPPLIES</b>						
Logic Supply	$V_{LOGIC}$		2.7		5.5	V
Power Single-Supply Range	$V_{DD\text{ RANGE}}$	$V_{SS} = 0\text{ V}$	-0.3		5.5	V
Power Dual-Supply Range	$V_{DD/SS\text{ RANGE}}$		$\pm 2.3$		$\pm 2.7$	V
Positive Supply Current	$I_{DD}$	$V_{IH} = +5\text{ V}$ or $V_{IL} = 0\text{ V}$		15	40	$\mu\text{A}$
Negative Supply Current	$I_{SS}$	$V_{SS} = -5\text{ V}$		15	40	$\mu\text{A}$
Power Dissipation <sup>9</sup>	$P_{DISS}$	$V_{IH} = +5\text{ V}$ or $V_{IL} = 0\text{ V}$ , $V_{DD} = +5\text{ V}$ , $V_{SS} = -5\text{ V}$			0.2	mW
Power Supply Sensitivity	PSS	$\Delta V_{DD} = +5\text{ V} \pm 10\%$	-0.01	0.001	+0.01	%/%
<b>DYNAMIC CHARACTERISTICS<sup>7,10</sup></b>						
Bandwidth -3 dB	BW_10 k $\Omega$	$R_{AB} = 10\text{ k}\Omega$ , Code = 10 <sub>H</sub>		600		kHz
	BW_50 k $\Omega$	$R_{AB} = 50\text{ k}\Omega$ , Code = 10 <sub>H</sub>		100		kHz
Total Harmonic Distortion	THD <sub>W</sub>	$V_A = 1\text{ V rms}$ , $V_B = 0\text{ V}$ , $f = 1\text{ kHz}$ , $R_{AB} = 10\text{ k}\Omega$		0.003		%
$V_W$ Settling Time (10 k $\Omega$ /50 k $\Omega$ )	$t_S$	$V_A = 5\text{ V}$ , $V_B = 0\text{ V}$ , $\pm 1\text{ LSB Error Band}$		2/9		$\mu\text{s}$
Resistor Noise Voltage Density	$e_{N\_WB}$	$R_{WB} = 5\text{ k}\Omega$ , $R_S = 0$		9		$\text{nV}\sqrt{\text{Hz}}$

**NOTES**

<sup>1</sup>Typicals represent average readings at  $25^\circ\text{C}$  and  $V_{DD} = 5\text{ V}$ ,  $V_{SS} = 0\text{ V}$ .

<sup>2</sup>Resistor position nonlinearity error R-INL is the deviation from an ideal value measured between the maximum resistance and the minimum resistance wiper positions. R-DNL measures the relative step change from ideal between successive tap positions. Parts are guaranteed monotonic.  $I_W = V_{DD}/R$  for both  $V_{DD} = +2.7\text{ V}$ ,  $V_{SS} = -2.7\text{ V}$ .

<sup>3</sup> $V_{AB} = V_{DD}$ , Wiper ( $V_W$ ) = No connect.

<sup>4</sup>Six bits are needed for 33 positions even though it is not a 64-position device.

<sup>5</sup>INL and DNL are measured at  $V_W$  with the RDAC configured as a potentiometer divider similar to a voltage output D/A converter.  $V_A = V_{DD}$  and  $V_B = 0\text{ V}$ . DNL specification limits of  $\pm 1\text{ LSB}$  maximum are Guaranteed Monotonic operating conditions.

<sup>6</sup>Resistor Terminals A, B, W have no limitations on polarity with respect to each other.

<sup>7</sup>Guaranteed by design and not subject to production test.

<sup>8</sup>Measured at the A terminal. A terminal is open-circuited in shutdown mode.

<sup>9</sup> $P_{DISS}$  is calculated from ( $I_{DD} \times V_{DD}$ ). CMOS logic level inputs result in minimum power dissipation.

<sup>10</sup>All dynamic characteristics use  $V_{DD} = 5\text{ V}$ ,  $V_{SS} = 0\text{ V}$ .

Specifications subject to change without notice.

# AD5200/AD5201—SPECIFICATIONS

## ELECTRICAL CHARACTERISTICS ( $V_{DD} = 5\text{ V} \pm 10\%$ , or $3\text{ V} \pm 10\%$ , $V_{SS} = 0\text{ V}$ , $V_A = +V_{DD}$ , $V_B = 0\text{ V}$ , $-40^\circ\text{C} < T_A < +85^\circ\text{C}$ unless otherwise noted.)

Parameter	Symbol	Conditions	Min	Typ <sup>1</sup>	Max	Unit
INTERFACE TIMING CHARACTERISTICS (Applies to All Parts [Notes 2, 3])						
Input Clock Pulsewidth	$t_{CH}, t_{CL}$	Clock Level High or Low	20			ns
Data Setup Time	$t_{DS}$		5			ns
Data Hold Time	$t_{DH}$		5			ns
$\overline{\text{CS}}$ Setup Time	$t_{CSS}$		15			ns
$\overline{\text{CS}}$ High Pulsewidth	$t_{CSW}$		40			ns
CLK Fall to $\overline{\text{CS}}$ Fall Hold Time	$t_{CSH0}$		0			ns
CLK Fall to $\overline{\text{CS}}$ Rise Hold Time	$t_{CSH1}$		0			ns
$\overline{\text{CS}}$ Rise to Clock Rise Setup	$t_{CS1}$		10			ns

### NOTES

<sup>1</sup>Typicals represent average readings at 25°C and  $V_{DD} = 5\text{ V}$ ,  $V_{SS} = 0\text{ V}$ .

<sup>2</sup>Guaranteed by design and not subject to production test.

<sup>3</sup>See timing diagram for location of measured values. All input control voltages are specified with  $t_R = t_F = 2\text{ ns}$  (10% to 90% of 3 V) and timed from a voltage level of 1.5 V. Switching characteristics are measured using  $V_{LOGIC} = 5\text{ V}$ .

Specifications subject to change without notice.

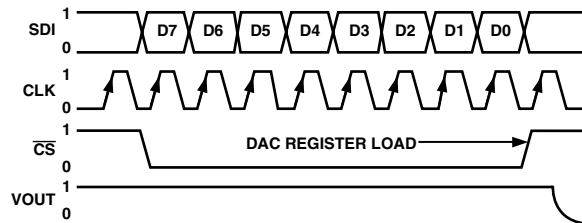

Figure 1a. AD5200 Timing Diagram

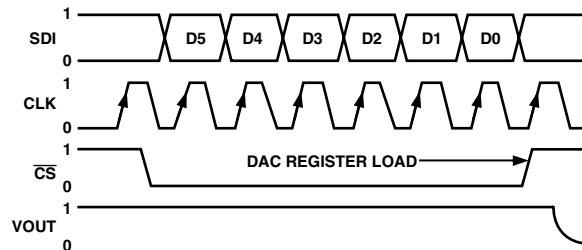

Figure 1b. AD5201 Timing Diagram

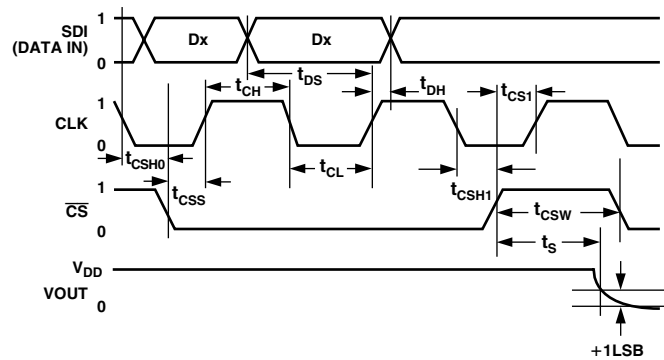

Figure 1c. Detail Timing Diagram

## ABSOLUTE MAXIMUM RATINGS<sup>1</sup>

(T<sub>A</sub> = 25°C, unless otherwise noted)

V <sub>DD</sub> to V <sub>SS</sub> .....	7 V
V <sub>DD</sub> to GND .....	-0.3, +7 V
V <sub>SS</sub> to GND .....	0 V, -7 V
V <sub>A</sub> , V <sub>B</sub> , V <sub>W</sub> to GND .....	V <sub>SS</sub> , V <sub>DD</sub>
I <sub>MAX</sub> .....	±20 mA <sup>2</sup>
Digital Inputs and Output Voltage to GND .....	0 V, 7 V
Operating Temperature Range .....	-40°C to +85°C
Maximum Junction Temperature (T <sub>J</sub> Max) .....	150°C
Storage Temperature .....	-65°C to +150°C
Lead Temperature (Soldering, 10 sec) .....	300°C
Thermal Resistance θ <sub>JA</sub> , μSOIC-10 .....	200°C/W
Package Power Dissipation = (T <sub>J</sub> Max - T <sub>A</sub> )/θ <sub>JA</sub>	

### NOTES

<sup>1</sup>Stresses above those listed under Absolute Maximum Ratings may cause permanent damage to the device. This is a stress rating; functional operation of the device at these or any other conditions above those listed in the operational sections of this specification is not implied. Exposure to absolute maximum rating conditions for extended periods may affect device reliability.

<sup>2</sup>Max current is bounded by the maximum current handling of the switches, maximum power dissipation of the package, and maximum applied voltage across any two of the A, B, and W terminals at a given resistance. Please refer to TPC 31 and TPC 32 for detail.

## PIN FUNCTION DESCRIPTIONS

Pin	Name	Description
1	B	B Terminal.
2	V <sub>SS</sub>	Negative Power Supply, specified for operation from 0 V to -2.7 V.
3	GND	Ground.
4	$\overline{\text{CS}}$	Chip Select Input, Active Low. When $\overline{\text{CS}}$ returns high, data will be loaded into the DAC register.
5	SDI	Serial Data Input.
6	CLK	Serial Clock Input, positive edge triggered.
7	$\overline{\text{SHDN}}$	Active Low Input. Terminal A open circuit. Shutdown controls Variable Resistors of RDAC to temporary infinite.
8	V <sub>DD</sub>	Positive Power Supply (Sum of V <sub>DD</sub> + V <sub>SS</sub> ≤ 5.5 V).
9	W	Wiper Terminal.
10	A	A Terminal.

## PIN CONFIGURATION

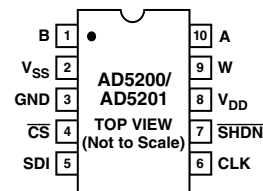

## ORDERING GUIDE

Model	RES	kΩ	Temperature Range	Package Description	Package Option	Full Reel Qty.	Branding Information
AD5200BRM10-REEL7	256	10	-40°C/+85°C	μSOIC-10	RM-10	5000	DLA
AD5200BRM50-REEL7	256	50	-40°C/+85°C	μSOIC-10	RM-10	5000	DLB
AD5201BRM10-REEL7	33	10	-40°C/+85°C	μSOIC-10	RM-10	5000	DMA
AD5201BRM50-REEL7	33	50	-40°C/+85°C	μSOIC-10	RM-10	5000	DMB

## CAUTION

ESD (electrostatic discharge) sensitive device. Electrostatic charges as high as 4000 V readily accumulate on the human body and test equipment and can discharge without detection. Although the AD5200/AD5201 features proprietary ESD protection circuitry, permanent damage may occur on devices subjected to high-energy electrostatic discharges. Therefore, proper ESD precautions are recommended to avoid performance degradation or loss of functionality.



# AD5200/AD5201—Typical Performance Characteristics

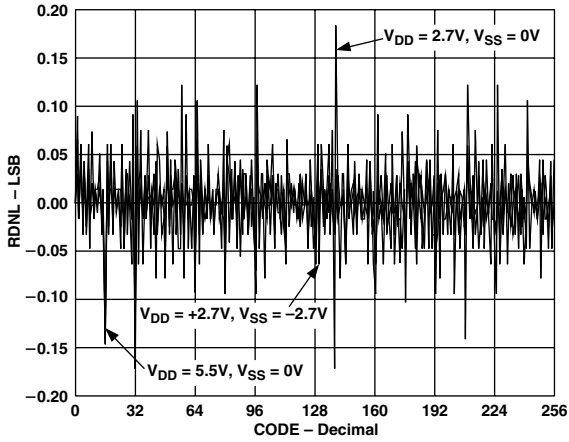

TPC 1. AD5200 10 kΩ RDNL vs. Code

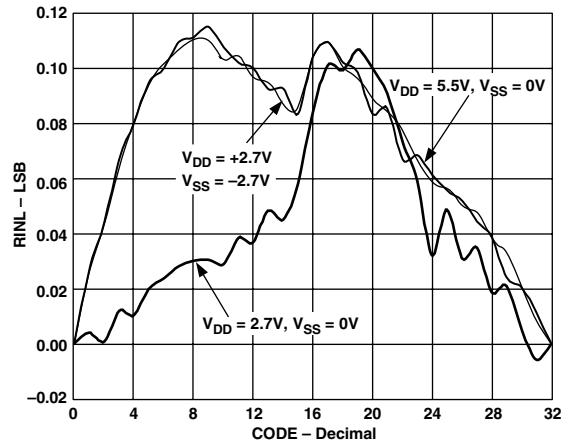

TPC 4. AD5201 10 kΩ RINL vs. Code

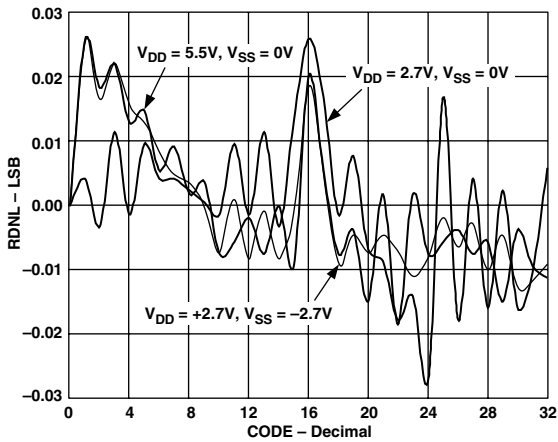

TPC 2. AD5201 10 kΩ RDNL vs. Code

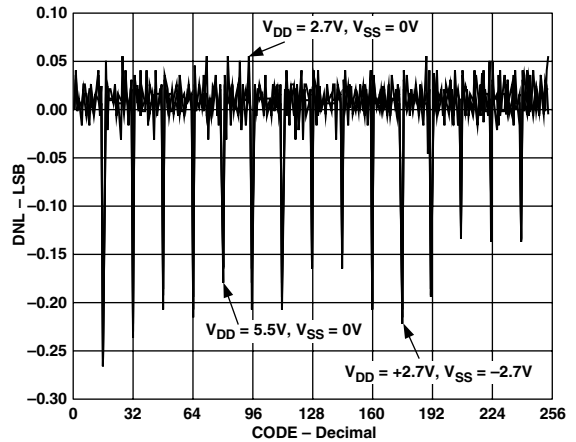

TPC 5. AD5200 10 kΩ DNL vs. Code

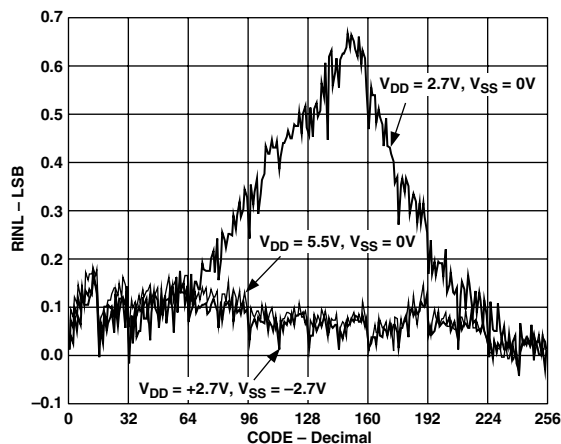

TPC 3. AD5200 10 kΩ RINL vs. Code

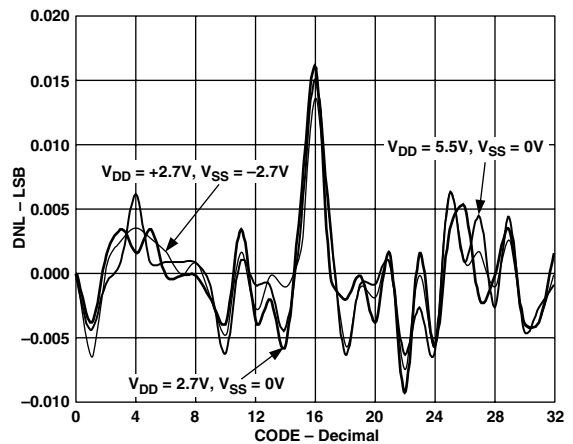

TPC 6. AD5201 10 kΩ DNL vs. Code

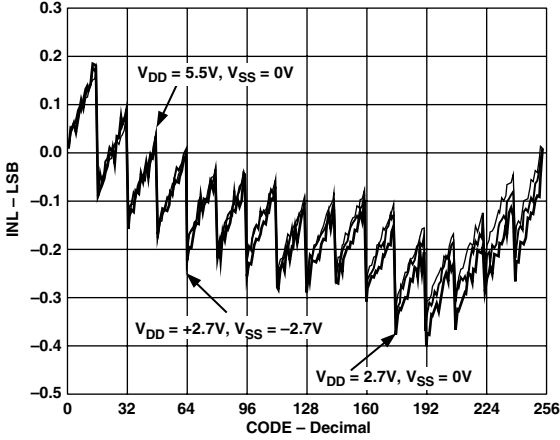

TPC 7. AD5200 10 kΩ INL vs. Code

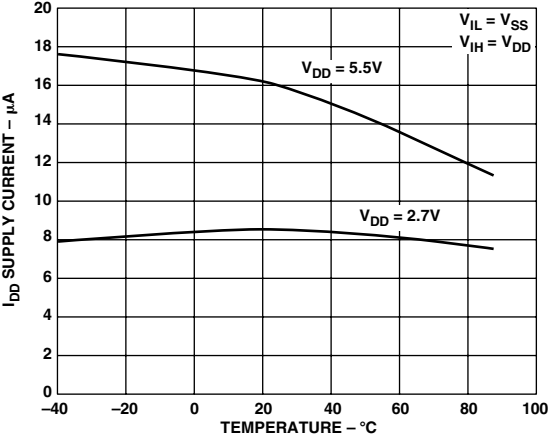

TPC 10. Supply Current vs. Temperature

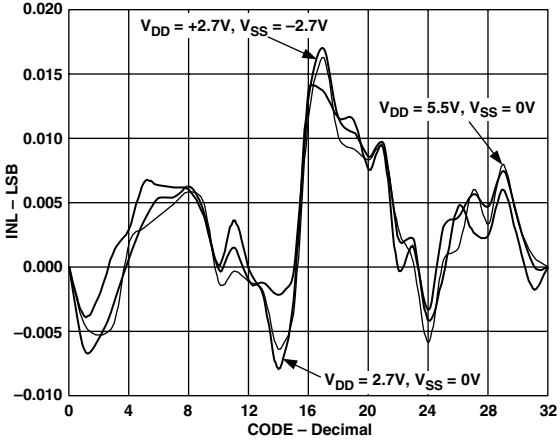

TPC 8. AD5201 10 kΩ INL vs. Code

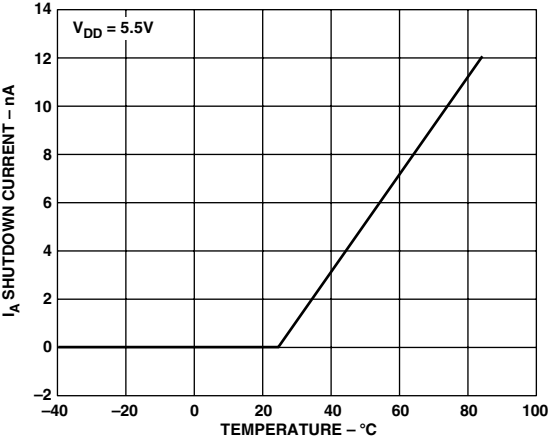

TPC 11. Shutdown Current vs. Temperature

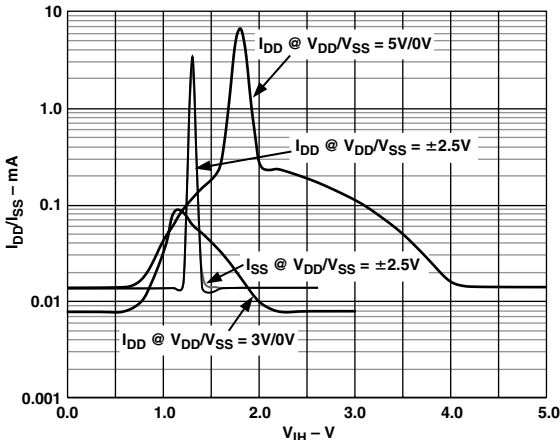

TPC 9. Supply Current vs. Logic Input Voltage

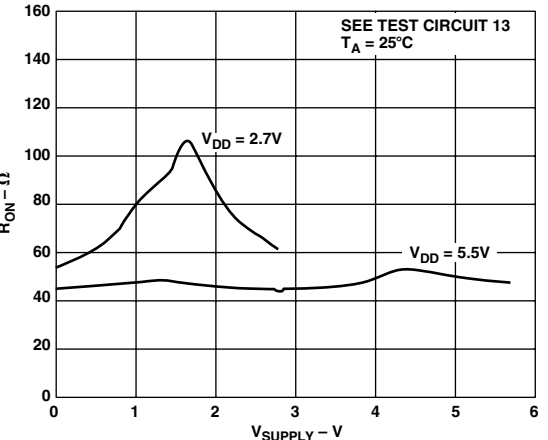

TPC 12. Wiper ON Resistance vs.  $V_{SUPPLY}$

# AD5200/AD5201

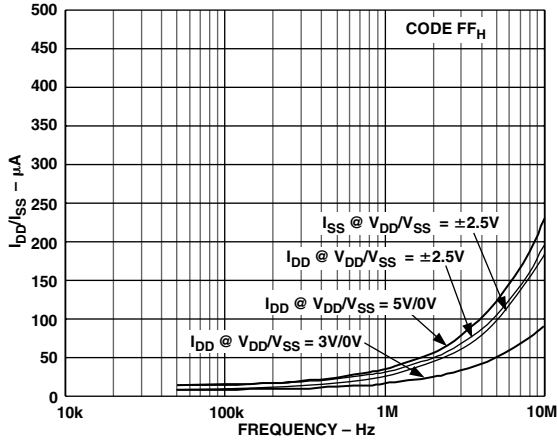

TPC 13. AD5200 10 kΩ Supply Current vs. Clock Frequency

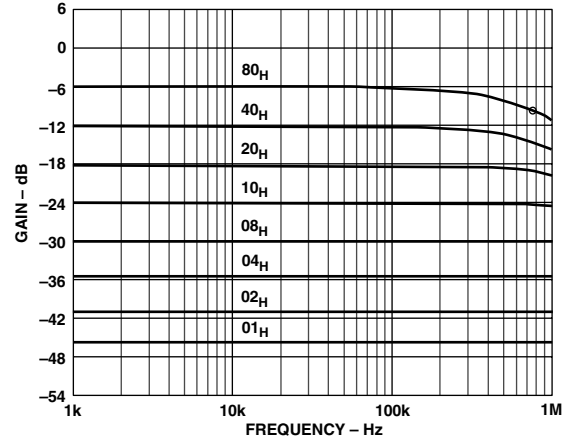

TPC 16. AD5200 10 kΩ Gain vs. Frequency vs. Code

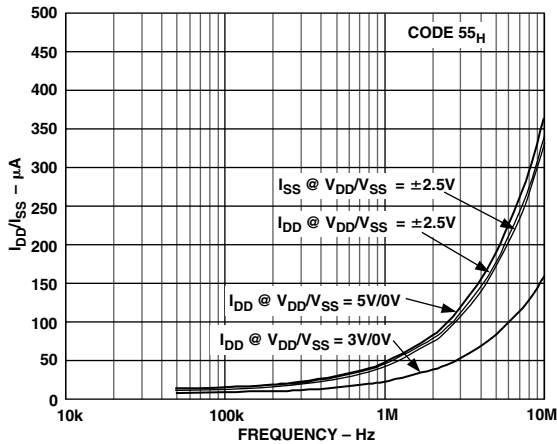

TPC 14. AD5200 10 kΩ Supply Current vs. Clock Frequency

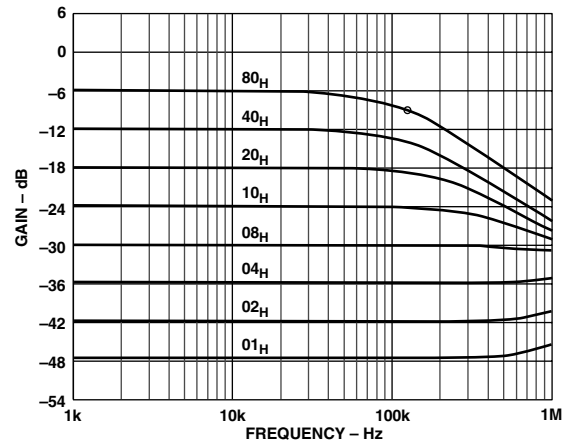

TPC 17. AD5200 50 kΩ Gain vs. Frequency vs. Code

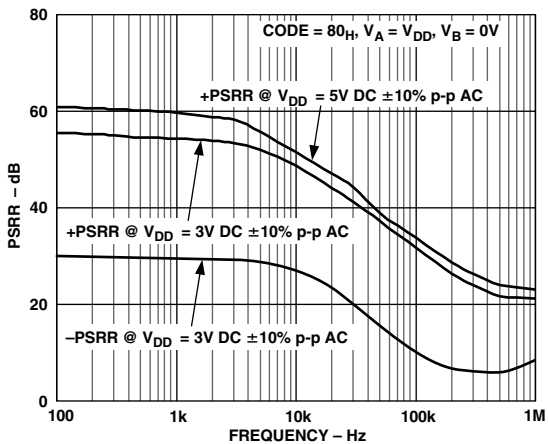

TPC 15. Power Supply Rejection Ratio vs. Frequency

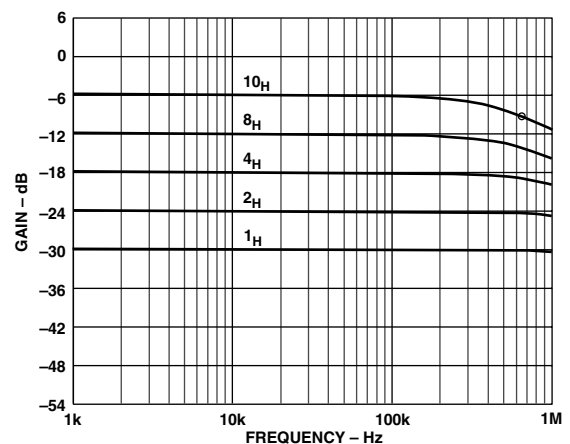

TPC 18. AD5201 10 kΩ Gain vs. Frequency vs. Code



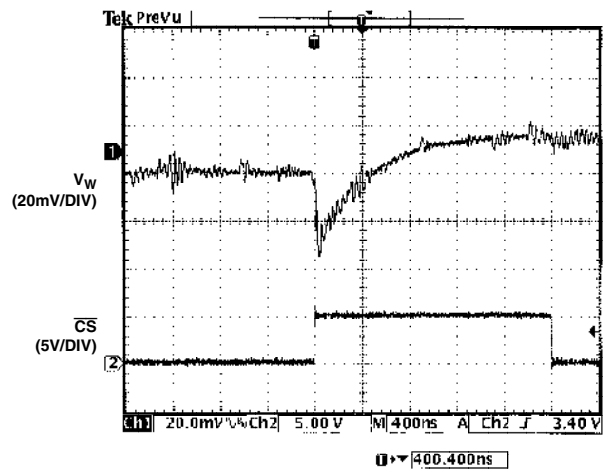
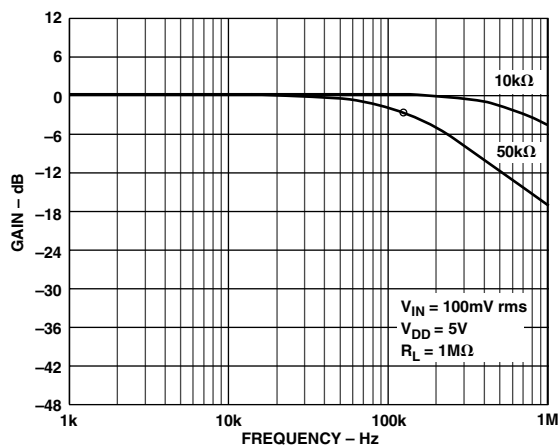
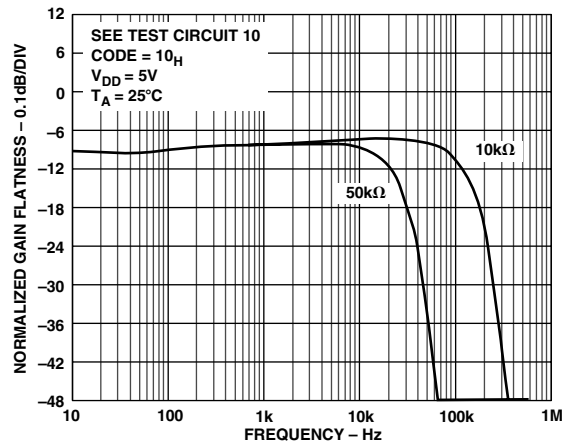
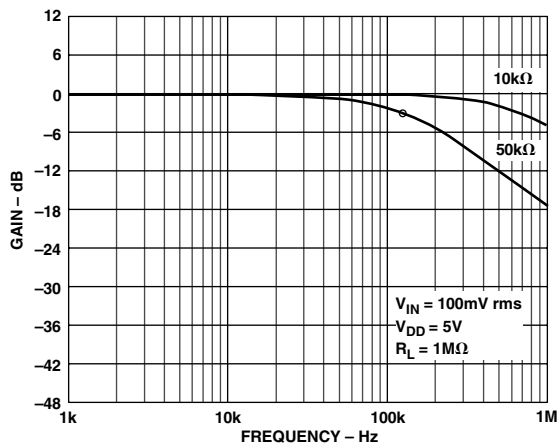
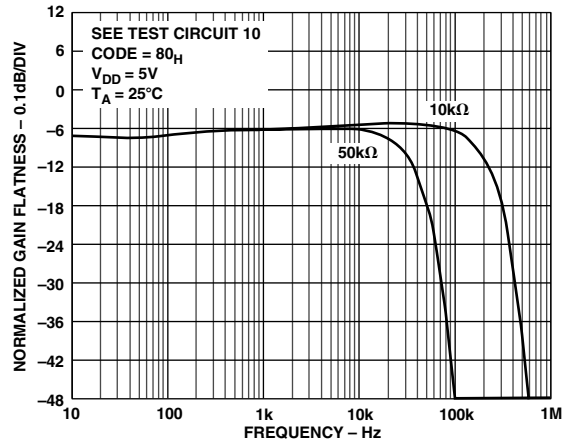
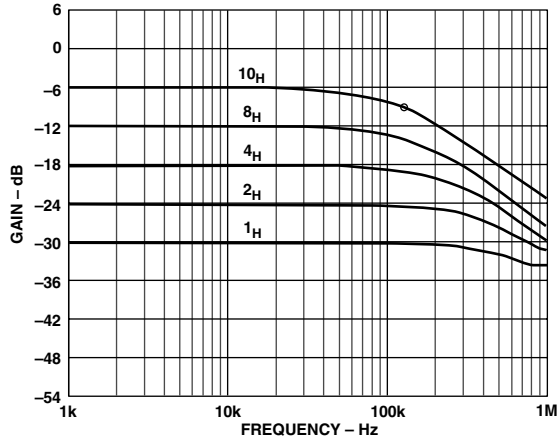

# AD5200/AD5201

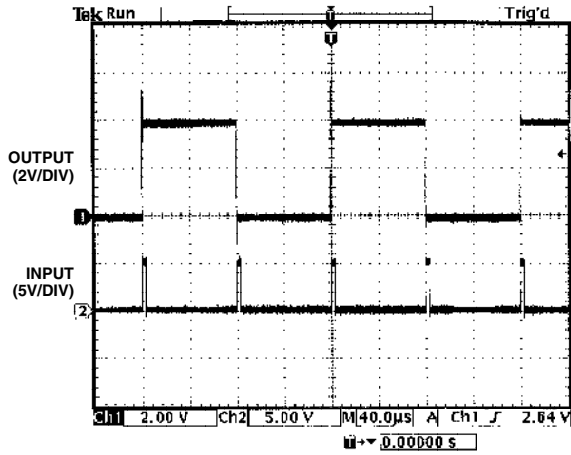

TPC 25. Large Signal Settling Time

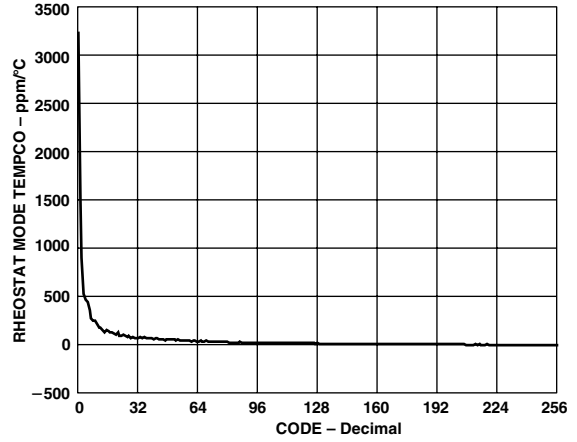

TPC 28. AD5200  $\Delta R_{WB}/\Delta T$  Rheostat Mode Temperature Coefficient

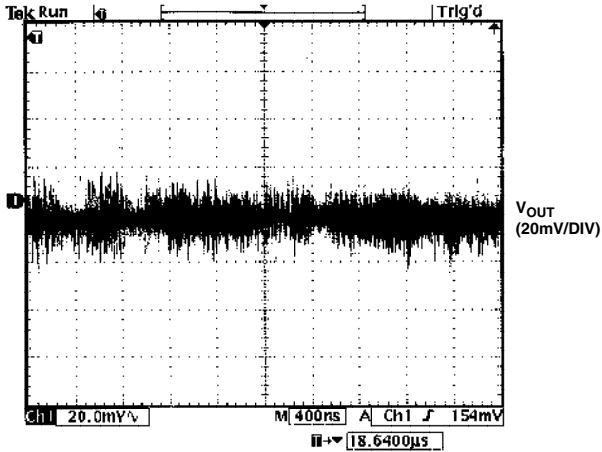

TPC 26. Digital Feedthrough vs. Time

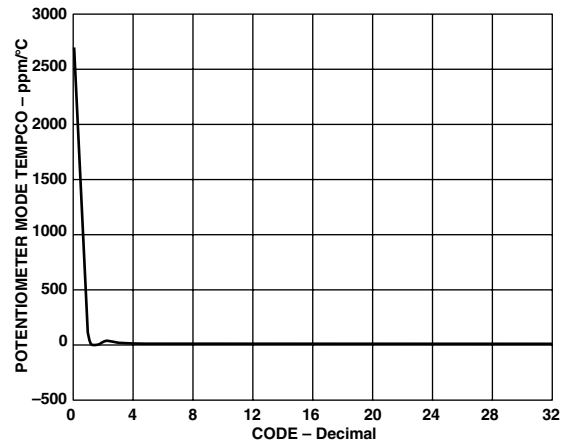

TPC 29. AD5201 Potentiometer Mode Temperature Coefficient

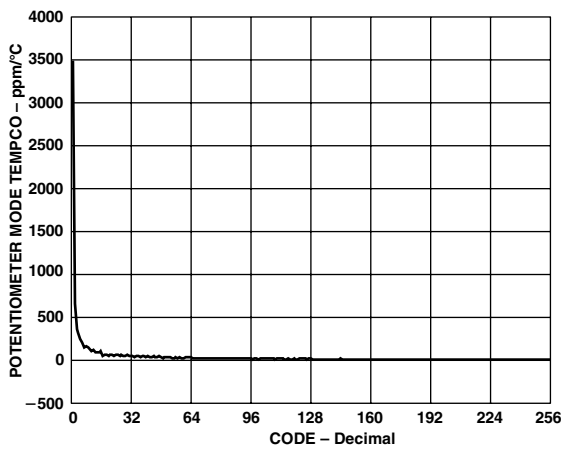

TPC 27. AD5200  $\Delta V_{WB}/\Delta T$  Potentiometer Mode Temperature Coefficient

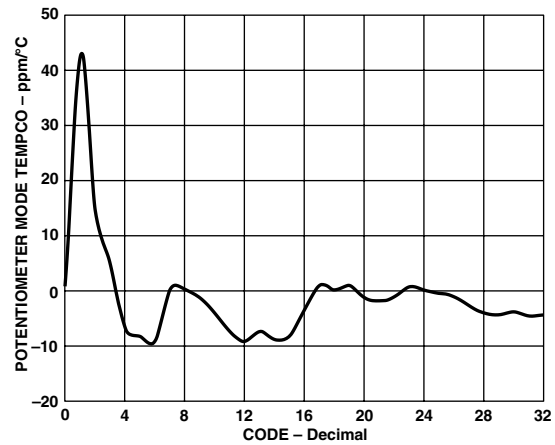

TPC 30. AD5201  $\Delta V_{WB}/\Delta T$  Potentiometer Mode Tempco

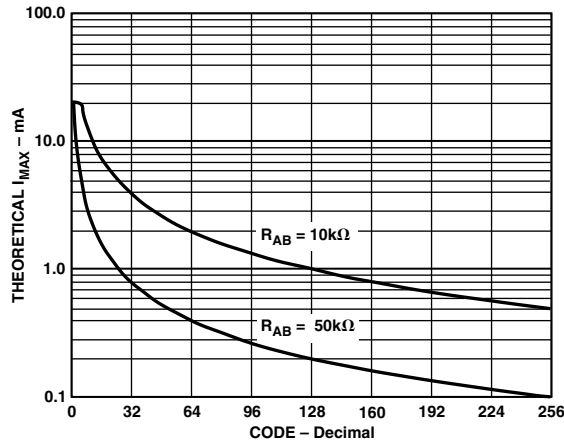

TPC 31. AD5200  $I_{MAX}$  vs. Code

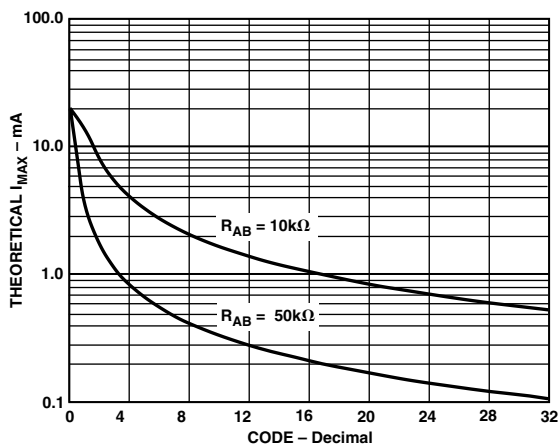

TPC 32. AD5201  $I_{MAX}$  vs. Code

### OPERATION

The AD5200/AD5201 provide 255 and 33 positions digitally-controlled variable resistor (VR) devices. Changing the programmed VR settings is accomplished by clocking in an 8-bit serial data word for AD5200, and a 6-bit serial data word for AD5201, into the SDI (Serial Data Input) pins. Table I provides the serial register data word format. The AD5200/AD5201 are preset to a midscale internally during power-on condition. In addition, the AD5200/AD5201 contain power shutdown SHDN pins that place the RDAC in a zero power consumption state where the immediate switches next to Terminals A and B are open-circuited. Meanwhile, the wiper W is connected to B terminal, resulting in only leakage current consumption in the VR structure. During shutdown, the VR latch contents are maintained when the RDAC is inactive. When the part is returned from shutdown, the stored VR setting will be applied to the RDAC.

Table I. AD5200 Serial-Data Word Format

<b>B7</b>	<b>B6</b>	<b>B5</b>	<b>B4</b>	<b>B3</b>	<b>B2</b>	<b>B1</b>	<b>B0</b>
<b>D7</b>	<b>D6</b>	<b>D5</b>	<b>D4</b>	<b>D3</b>	<b>D2</b>	<b>D1</b>	<b>D0</b>
<b>MSB</b>							<b>LSB</b>
$2^7$							$2^0$

Table II. AD5201 Serial-Data Word Format

<b>B5*</b>	<b>B4</b>	<b>B3</b>	<b>B2</b>	<b>B1</b>	<b>B0</b>
<b>D5*</b>	<b>D4</b>	<b>D3</b>	<b>D2</b>	<b>D1</b>	<b>D0</b>
<b>MSB</b>					<b>LSB</b>
$2^5$					$2^0$

\*Six data bits are needed for 33 positions.

### PROGRAMMING THE VARIABLE RESISTOR

#### Rheostat Operation

The nominal resistance of the RDAC between Terminals A and B are available with values of 10 kΩ and 50 kΩ. The final two digits of the part number determine the nominal resistance value, e.g., 10 kΩ = 10 and 50 kΩ = 50. The nominal resistance ( $R_{AB}$ ) of AD5200 has 256 contact points accessed by the wiper terminal. The 8-bit data word in the RDAC latch of AD5200 is decoded to select one of the 256 possible settings. In both parts, the wiper's first connection starts at the B terminal for data 00<sub>H</sub>. This B-terminal connection has a wiper contact resistance of 50 Ω as long as valid  $V_{DD}/V_{SS}$  is applied, regardless of the nominal resistance. For a 10 kΩ part, the second connection of AD5200 is the first tap point with 89 Ω [ $R_{WB} = R_{AB}/255 + R_w = 39 \Omega + 50 \Omega$ ] for data 01<sub>H</sub>. The third connection is the next tap point representing 78 + 50 = 128 Ω for data 02<sub>H</sub>. Due to its unique internal structure, AD5201 has 5-bit + 1 resolution, but needs a 6-bit data word to achieve the full 33 steps resolution. The 6-bit data word in the RDAC latch is decoded to select one of the 33 possible settings. Data 34 to 63 will automatically be equal to Position 33. The wiper 00<sub>H</sub> connection of AD5201 gives 50 Ω. Similarly, for a 10 kΩ part, the first tap point of AD5201 yields 363 Ω for data 01<sub>H</sub>, 675 Ω for data 02<sub>H</sub>. For both AD5200 and AD5201, each LSB data value increase moves the wiper up the resistor ladder until the last tap point is reached. Figures 2a and 2b show the simplified diagrams of the equivalent RDAC circuits.

# AD5200/AD5201

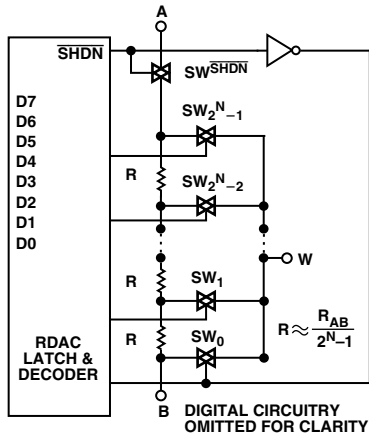

Figure 2a. AD5200 Equivalent RDAC Circuit. 255 positions can be achieved up to Switch  $SW_{2^N-1}$ .

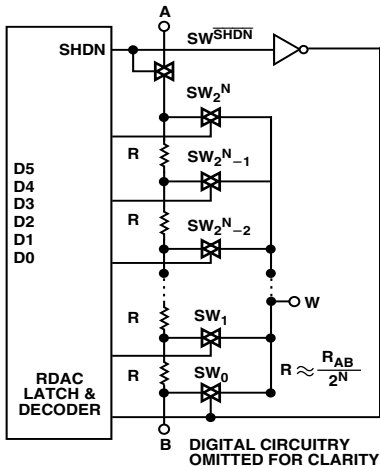

Figure 2b. AD5201 Equivalent RDAC Circuit. Unlike AD5200, 33 positions can be achieved all the way to Switch  $SW_{2^N}$ .

The general equation determining the digitally programmed output resistance between W and B is:

$$R_{WB}(D) = \frac{D}{255} R_{AB} + 50 \Omega \quad \text{for AD5200} \quad (1)$$

$$R_{WB}(D) = \frac{D}{32} R_{AB} + 50 \Omega \quad \text{for AD5201} \quad (2)$$

where:

$D$  is the decimal equivalent of the data contained in RDAC latch.

$R_{AB}$  is the nominal end-to-end resistance.

$R_W$  is the wiper resistance contributed by the on-resistance of the internal switch.

Note  $D$  in AD5200 is between 0 to 255 for 256 positions. On the other hand,  $D$  in AD5201 is between 0 to 32 so that 33 positions can be achieved due to the slight internal structure difference, Figure 2b.

Again if  $R_{AB} = 10 \text{ k}\Omega$  and A terminal can be opened or tied to W, the following output resistance between W to B will be set for the following RDAC latch codes:

AD5200 Wiper-to-B Resistance

D (DEC)	$R_{WB}$ ( $\Omega$ )	Output State
255	10050	Full-Scale ( $R_{AB} + R_W$ )
128	5070	Midscale
1	89	1 LSB
0	50	Zero-Scale (Wiper Contact Resistance)

AD5201 Wiper-to-B Resistance

D (DEC)	$R_{WB}$ ( $\Omega$ )	Output State
32	10050	Full-Scale ( $R_{AB} + R_W$ )
16	5050	Midscale
1	363	1 LSB
0	50	Zero-Scale (Wiper Contact Resistance)

Note that in the zero-scale condition a finite wiper resistance of  $50 \Omega$  is present. Care should be taken to limit the current flow between W and B in this state to no more than  $\pm 20 \text{ mA}$  to avoid degradation or possible destruction of the internal switch contact.

Like the mechanical potentiometer the RDAC replaces, it is totally symmetrical. The resistance between the wiper W and Terminal A also produces a digitally controlled resistance  $R_{WA}$ . When these terminals are used, the B terminal should be tied to the wiper. Setting the resistance value for  $R_{WA}$  starts at a maximum value of resistance and decreases as the data loaded in the latch is increased in value. The general equation for this operation is:

$$R_{WA}(D) = \frac{(255 - D)}{255} R_{AB} + 50 \Omega \quad \text{for AD5200} \quad (3)$$

$$R_{WA}(D) = \frac{(32 - D)}{32} R_{AB} + 50 \Omega \quad \text{for AD5201} \quad (4)$$

Similarly,  $D$  in AD5200 is between 0 to 255, whereas  $D$  in AD5201 is between 0 to 32.

For  $R_{AB} = 10 \text{ k}\Omega$  and B terminal is opened or tied to the wiper W, the following output resistance between W and A will be set for the following RDAC latch codes:

### AD5200 Wiper-to-A Resistance

D (DEC)	R <sub>WA</sub> (Ω)	Output State
255	50	Full-Scale (R <sub>W</sub> )
128	5030	Midscale
1	10011	1 LSB
0	10050	Zero-Scale (R <sub>AB</sub> + R <sub>W</sub> )

### AD5201 Wiper-to-A Resistance

D (DEC)	R <sub>WA</sub> (Ω)	Output State
32	50	Full-Scale (R <sub>W</sub> )
16	5050	Midscale
1	9738	1 LSB
0	10050	Zero-Scale (R <sub>AB</sub> + R <sub>W</sub> )

The tolerance of the nominal resistance can be ±30% due to process lot dependance. If users apply the RDAC in rheostat (variable resistance) mode, they should be aware of such specification of tolerance. The change in R<sub>AB</sub> with temperature has a 500 ppm/°C temperature coefficient.

### PROGRAMMING THE POTENTIOMETER DIVIDER

#### Voltage Output Operation

The digital potentiometer easily generates output voltages at wiper-to-B and wiper-to-A to be proportional to the input voltage at A to B.

Unlike the polarity of V<sub>DD</sub> – V<sub>SS</sub>, which must be positive, voltage across A–B, W–A, and W–B can be at either polarity.

If ignoring the effects of the wiper resistance for an approximation, connecting A terminal to 5 V and B terminal to ground produces an output voltage at the wiper which can be any value starting at almost zero to almost full scale with the minor deviation contributed by the wiper resistance. Each LSB of voltage is equal to the voltage applied across Terminal AB divided by the 2<sup>N</sup>-1 and 2<sup>N</sup> position resolution of the potentiometer divider for AD5200 and AD5201 respectively. The general equation defining the output voltage with respect to ground for any valid input voltage applied to Terminals A and B is:

$$V_W(D) = \frac{D}{255} V_{AB} + V_B \quad \text{for AD5200} \quad (5)$$

$$V_W(D) = \frac{D}{32} V_{AB} + V_B \quad \text{for AD5201} \quad (6)$$

where D in AD5200 is between 0 to 255 and D in AD5201 is between 0 to 32.

For more accurate calculation, including the effects of wiper resistance, V<sub>W</sub> can be found as:

$$V_W(D) = \frac{R_{WB}(D)}{R_{AB}} V_A + \frac{R_{WA}(D)}{R_{AB}} V_B \quad (7)$$

where R<sub>WB</sub>(D) and R<sub>WA</sub>(D) can be obtained from Equations 1 to 4.

Operation of the digital potentiometer in the divider mode results in more accurate operation over temperature. Here the output voltage is dependent on the ratio of the internal resistors and not the absolute values; therefore, the drift reduces to 15 ppm/°C.

### DIGITAL INTERFACING

The AD5200/AD5201 contain a standard three-wire serial input control interface. The three inputs are clock (CLK),  $\overline{\text{CS}}$ , and serial data input (SDI). The positive-edge-sensitive CLK input requires clean transitions to avoid clocking incorrect data into the serial input register. Standard logic families work well. If mechanical switches are used for product evaluation, they should be debounced by a flip-flop or other suitable means. Figure 3 shows more detail of the internal digital circuitry. When  $\overline{\text{CS}}$  is low, the clock loads data into the serial register on each positive clock edge (see Table III).

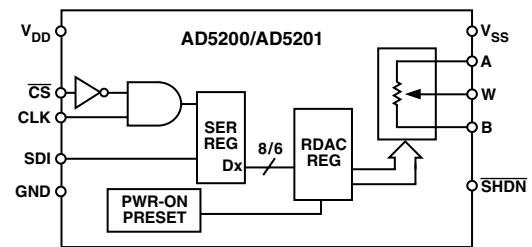

Figure 3. Block Diagram

Table III. Input Logic Control Truth Table

CLK	$\overline{\text{CS}}$	SHDN	Register Activity
L	L	H	No SR effect.
P	L	H	Shift one bit in from the SDI pin.
X	P	H	Load SR data into RDAC latch.
X	H	H	No operation.
X	H	L	Open circuit on A terminal and short circuit between W to B terminals.

NOTE

P = positive edge, X = don't care, SR = shift register.

All digital inputs are protected with a series input resistor and parallel Zener ESD structure shown in Figure 4. Applies to digital input pins  $\overline{\text{CS}}$ , SDI, SHDN, CLK.

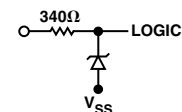

Figure 4. ESD Protection of Digital Pins

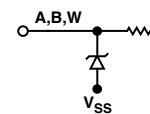

Figure 5. ESD Protection of Resistor Terminals

# AD5200/AD5201

## TEST CIRCUITS

Figures 6 to 14 define the test conditions used in the product specification table.

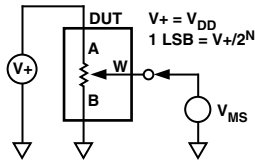

Figure 6. Potentiometer Divider Nonlinearity Error Test Circuit (INL, DNL)

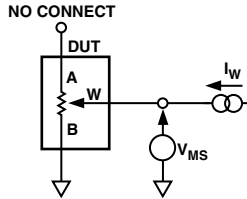

Figure 7. Resistor Position Nonlinearity Error (Rheostat Operation; R-INL, R-DNL)

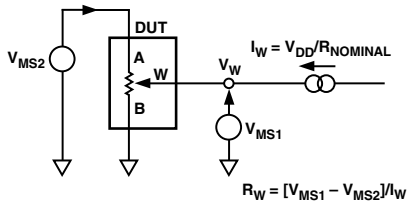

Figure 8. Wiper Resistance Test Circuit

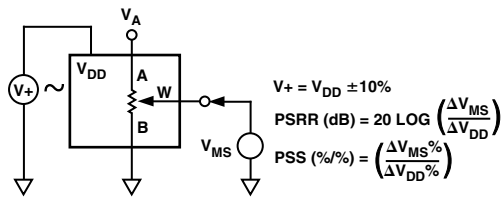

Figure 9. Power Supply Sensitivity Test Circuit (PSS, PSRR)

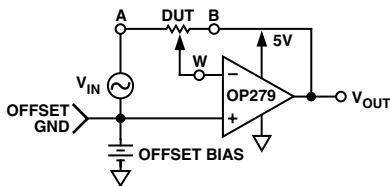

Figure 10. Inverting Gain Test Circuit

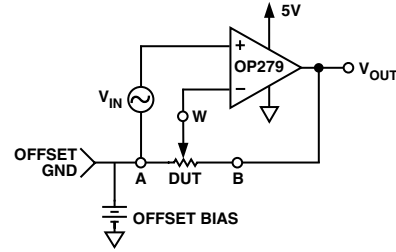

Figure 11. Noninverting Gain Test Circuit

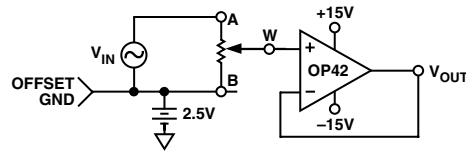

Figure 12. Gain vs. Frequency Test Circuit

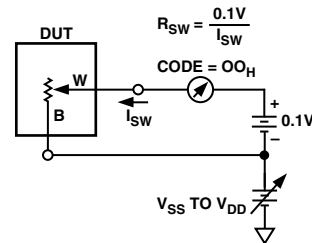

Figure 13. Incremental ON Resistance Test Circuit

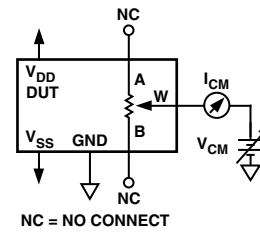

Figure 14. Common-Mode Leakage Current Test Circuit

## DIGITAL POTENTIOMETER SELECTION GUIDE

Part Number	Number of VRs per Package	Terminal Voltage Range	Interface Data Control	Nominal Resistance (k $\Omega$ )	Resolution (Number Of Wiper Positions)	Power Supply Current (I <sub>DD</sub> )	Packages	Comments
AD5201	1	$\pm 3$ V, +5.5 V	3-Wire	10, 50	33	60 $\mu$ A	$\mu$ SOIC-10	Full AC Specs, Dual Supply, Pwr-On-Reset, Low Cost
AD5220	1	5.5 V	Up/Down	10, 50, 100	128	40 $\mu$ A	PDIP, SO-8, $\mu$ SOIC-8	No Rollover, Pwr-On-Reset
AD7376	1	$\pm 15$ V, +28 V	3-Wire	10, 50, 100, 1000	128	100 $\mu$ A	PDIP-14, SOL-16, TSSOP-14	Single 28 V or Dual $\pm 15$ V Supply Operation
AD5200	1	$\pm 3$ V, +5.5 V	3-Wire	10, 50	256	60 $\mu$ A	$\mu$ SOIC-10	Full AC Specs, Dual Supply, Pwr-On-Reset
AD8400	1	5.5 V	3-Wire	1, 10, 50, 100	256	5 $\mu$ A	SO-8	Full AC specs
AD5241*	1	$\pm 3$ V, +5.5 V	2-Wire	10, 100, 1000	256	5 $\mu$ A	SO-14, TSSOP-14	I <sup>2</sup> C-Compatible, TC < 50 ppm/ $^{\circ}$ C
AD5231*	1	$\pm 3$ V, +5.5 V	3-Wire	10, 50, 100	1024	10 $\mu$ A	TSSOP-16	Nonvolatile Memory, Direct Program, I/D, $\pm 6$ dB Settability
AD5222	2	$\pm 3$ V, +5.5 V	Up/Down	10, 50, 100, 1000	128	80 $\mu$ A	SO-14, TSSOP-14	No Rollover, Stereo, Pwr-On-Reset, TC < 50 ppm/ $^{\circ}$ C
AD8402	2	5.5 V	3-Wire	1, 10, 50, 100	256	5 $\mu$ A	PDIP, SO-14, TSSOP-14	Full AC Specs, nA Shutdown Current
AD5232*	2	$\pm 3$ V, +5.5 V	3-Wire	10, 50, 100	256	10 $\mu$ A	TSSOP-16	Nonvolatile Memory, Direct Program, I/D, $\pm 6$ dB Settability
AD5242*	2	$\pm 3$ V, +5.5 V	2-Wire	10, 100, 1000	256	5 $\mu$ A	SO-16, TSSOP-16	I <sup>2</sup> C-Compatible, TC < 50 ppm/ $^{\circ}$ C
AD5262*	2	$\pm 5$ V, +12 V	3-Wire	10, 50, 100	256	60 $\mu$ A	TSSOP-16	Medium Voltage Operation, TC < 50 ppm/ $^{\circ}$ C
AD5203	4	5.5 V	3-Wire	10, 100	64	5 $\mu$ A	PDIP, SOL-24, TSSOP-24	Full AC specs, nA Shutdown Current
AD5233*	4	$\pm 3$ V, +5.5 V	3-Wire	10, 50, 100	64	10 $\mu$ A	TSSOP-16	Nonvolatile Memory, Direct Program, I/D, $\pm 6$ dB Settability
AD5204	4	$\pm 3$ V, +5.5 V	3-Wire	10, 50, 100	256	5 $\mu$ A	PDIP, SOL-24, TSSOP-24	Full AC Specs, Dual Supply, Pwr-On-Reset
AD8403	4	5.5 V	3-Wire	1, 10, 50, 100	256	5 $\mu$ A	PDIP, SOL-24, TSSOP-24	Full AC Specs, nA Shutdown Current
AD5206	6	$\pm 3$ V, +5.5 V	3-Wire	10, 50, 100	256	5 $\mu$ A	PDIP, SOL-24, TSSOP-24	Full AC Specs, Dual Supply, Pwr-On-Reset

\*Future product, consult factory for latest status.

# AD5200/AD5201

## OUTLINE DIMENSIONS

Dimensions shown in inches and (mm).

### 10-Lead $\mu$ SOIC (RM-10)

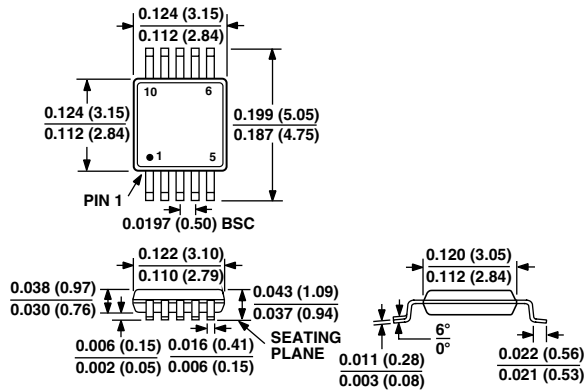

## Revision History

Location	Page
<b>Data Sheet changed from REV. A to REV. B.</b>	
Edits to ORDERING GUIDE .....	5
<b>02/01—Data Sheet changed from REV. O to REV. A.</b>	
Edits to ORDERING GUIDE .....	5
Edits to ABSOLUTE MAXIMUM RATINGS .....	5
TPCs 31 and 32 added .....	11