

Boost Chopper with Field Stop Trench IGBT + SiC SBD

$V_{CES} = 600V$
 $I_C = 40A @ T_C = 100^{\circ}C$



Features

- **Field StopTrench Fast IGBT**
 - Low voltage drop
 - Low tail current
 - Switching frequency up to 50 kHz
 - Low leakage current
- **Chopper SiC Schottky Diode**
 - Zero reverse recovery current
 - Temperature Independent switching behavior
 - Positive temperature coefficient on VF

Applications

- Solar inverters
- AC and DC motor control
- Power Factor Correction
- Aerospace Actuators

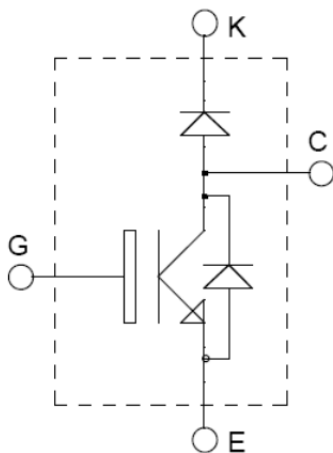

Benefits

- Outstanding performance at high frequency operation
- Low switching losses
- Very rugged
- Direct mounting to heatsink (isolated package)
- Low junction to case thermal resistance
- Easy paralleling due to positive T_C of V_{CESat}
- RoHS Compliant

Absolute Maximum Ratings ($T_j=25^{\circ}C$ unless otherwise specified)

Parameters	Symbol	Conditions	Specifications	Units
Collector - Emitter Breakdown Voltage	V_{CES}		600	V
Continuous Collector Current	I_C	$T_C = 25^{\circ}C$	80	A
		$T_C = 100^{\circ}C$	40	A
Gate-Emitter Voltage	V_{GES}		± 20	V
Pulsed Collector Current	ICM		120	A
Maximum Power Dissipation	P_D	$T_C = 25^{\circ}C$	277	W
		$T_C = 100^{\circ}C$	110	W
Operating Junction Temperature	T_j		-55 ~ 150	$^{\circ}C$
Storage Temperature	T_{STG}		-55 ~ 150	$^{\circ}C$

Electrical Characteristics ($T_j=25^{\circ}\text{C}$ unless otherwise specified)

Parameters	Symbol	Conditions	Min	Typ	Max	Units
OFF						
Zero Gate Voltage Collector Current	I_{CES}	$V_{CE} = 600\text{V}, V_{GE} = 0\text{V}$	--	--	1	mA
Gate-Emitter Leakage Current	I_{GES}	$V_{CE} = 0\text{V}, V_{GE} = 20\text{V}$	--	--	± 250	nA
ON						
Gate-Emitter Threshold Voltage	$V_{GE(TH)}$	$V_{GE} = V_{CE}, I_C = 40\text{mA}$	3.5	5.5	7.5	V
Collector-Emitter Saturation Voltage	$V_{CE(SAT)}$	$V_{CE} = 15\text{V}, I_C = 40\text{A}, T_j = 25^{\circ}\text{C}$	--	2.0	2.5	V
		$V_{CE} = 15\text{V}, I_C = 40\text{A}, T_j = 125^{\circ}\text{C}$	--	2.3	--	V
DYNAMIC						
Input Capacitance	C_{IES}	$V_{CE} = 30\text{V}, V_{GE} = 0\text{V}, f = 1\text{MHz}$	--	2720	--	pF
Output Capacitance	C_{OES}		--	125	--	pF
Reverse Transfer Capacitance	C_{RES}		--	75	--	pF
SWITCHING						
Turn-On Delay Time	$t_{d(on)}$	$V_{CC} = 400\text{V}, I_C = 40\text{A}$ $R_G = 5\Omega, V_{GE} = 15\text{V}$ Inductive Load, $T_j = 25^{\circ}\text{C}$	--	35	--	ns
Rise Time	t_r		--	75	--	ns
Turn-Off Delay Time	$t_{d(off)}$		--	85	--	ns
Fall Time	t_f		--	55	82	ns
Turn-On Switching Energy Loss	E_{ON}		--	0.2	--	mJ
Turn-Off Switching Energy Loss	E_{OFF}		--	0.7	--	mJ
Turn-On Delay Time	$t_{d(on)}$	$V_{CC} = 400\text{V}, I_C = 40\text{A}$ $R_G = 5\Omega, V_{GE} = 15\text{V}$ Inductive Load, $T_j = 125^{\circ}\text{C}$	--	35	--	ns
Rise Time	t_r		--	75	--	ns
Turn-Off Delay Time	$t_{d(off)}$		--	90	--	ns
Fall Time	t_f		--	70	--	ns
Turn-On Switching Energy Loss	E_{ON}		--	0.22	--	mJ
Turn-Off Switching Energy Loss	E_{OFF}		--	0.8	--	mJ
Total Gate Charge	Q_g	$V_{CC} = 400\text{V}, I_C = 40\text{A}$ $V_{GE} = 15\text{V}$	--	115	--	nC
Gate-Emitter Charge	Q_{ge}		--	18	--	nC
Gate-Collector Charge	Q_{gc}		--	56	--	nC
Short Circuit Withstanding Time	t_{sc}	$V_{CC} = 400\text{V}, V_{GE} = 15\text{V}$ $T_j = 125^{\circ}\text{C}$	--	--	10	μs

SiC Diode Rating and Characteristics ($T_j=25^{\circ}\text{C}$ unless otherwise specified)

Parameters	Symbol	Conditions	Min	Typ	Max	Units
Maximum peak repetitive reverse voltage	V_{RRM}		600	--	--	V
Maximum Reverse Leakage Current	I_{RM}	$V_R = 600\text{V}, T_j = 25^{\circ}\text{C}$	--	2.6	200	μA
		$V_R = 600\text{V}, T_j = 175^{\circ}\text{C}$	--	970	--	μA
Diode Forward Voltage	V_F	$I_F = 20\text{A}, T_j = 25^{\circ}\text{C}$	--	1.5	1.7	V
		$I_F = 20\text{A}, T_j = 175^{\circ}\text{C}$	--	2.2	--	V
Total Capacitive Charge	Q_C	$V_R=600\text{V}, I_F<I_{F,max}$	--	50	--	nC
Switching Time	t_C	$di_F/dt = 200\text{A}/\mu\text{s}, T_j = 175^{\circ}\text{C}$	--	--	10	ns
Total Capacitance	C	$V_R = 1\text{V}, f = 1\text{MHz}$	--	974	--	pF
		$V_R = 300\text{V}, f = 1\text{MHz}$	--	86	--	pF
		$V_R = 600\text{V}, f = 1\text{MHz}$	--	82	--	pF

Thermal and Package Characteristics ($T_j=25^{\circ}\text{C}$ unless otherwise specified)

Parameters	Symbol	Conditions	Min	Typ	Max	Units
Junction to Case Thermal Resistance	R_{THJC}	IGBT chip	--	--	0.54	$^{\circ}\text{C}/\text{W}$
		SiC SBD chip	--	--	1.5	$^{\circ}\text{C}/\text{W}$
Mounting Torque	M_d				1.5	N-m
Terminal Connection Torque	M_{dt}		1.3	--	1.5	N-m
Package Weight	W_t			32		g
Isolation Voltage	V_{ISOL}	$I_{ISOL} < 1\text{mA}, 50/60\text{Hz}, t=1\text{min}$	2500	V		

IGBT Characteristics

Fig. 1 Output characteristics

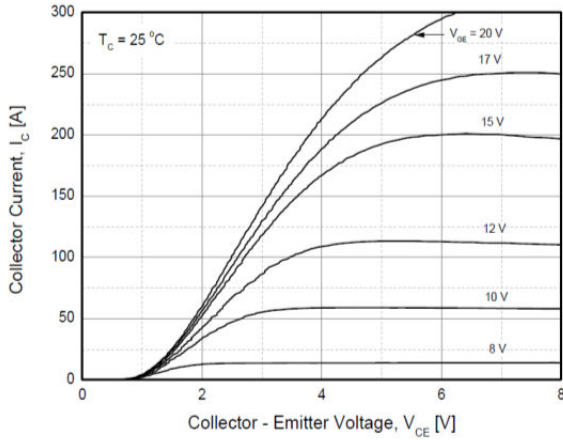

Fig. 2 Saturation voltage characteristics

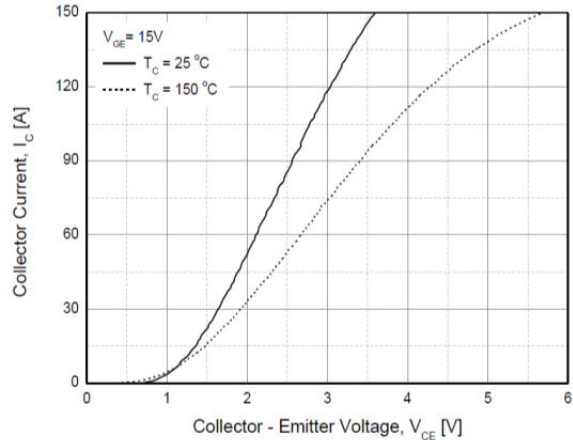

Fig. 3 Saturation voltage vs. collector current

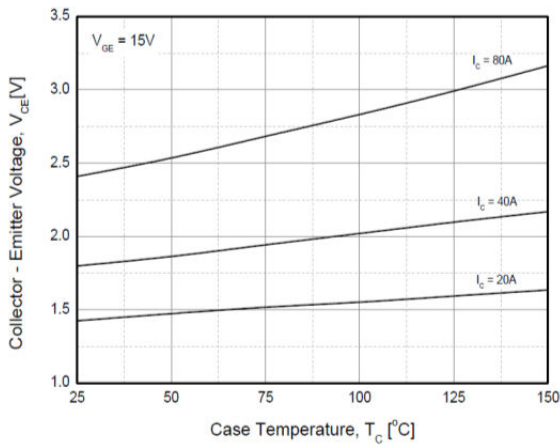

Fig. 4 Saturation voltage vs. gate bias

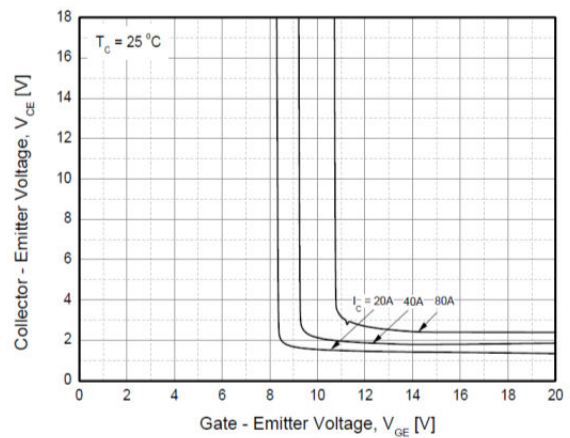

Fig. 5 Saturation voltage vs. gate bias

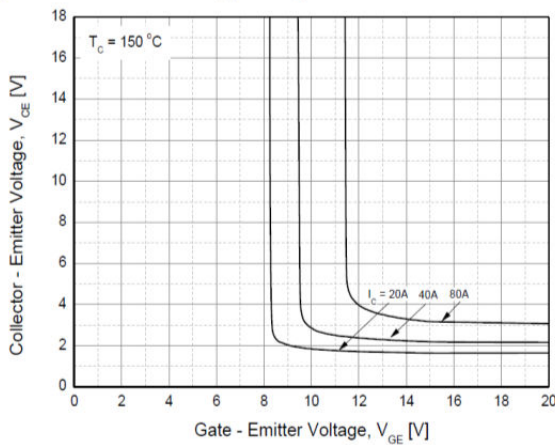

Fig. 6 Capacitance characteristics

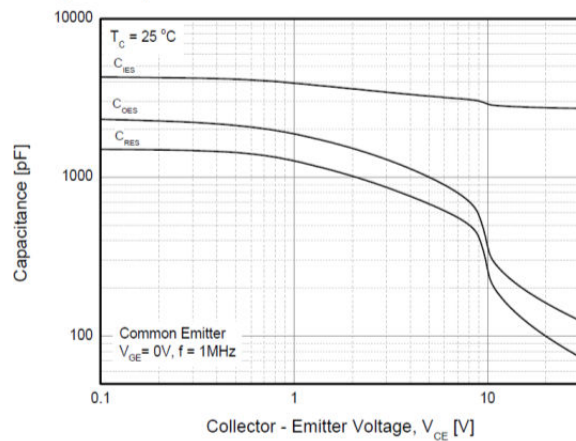

Fig. 7 Turn-on time vs. gate resistor

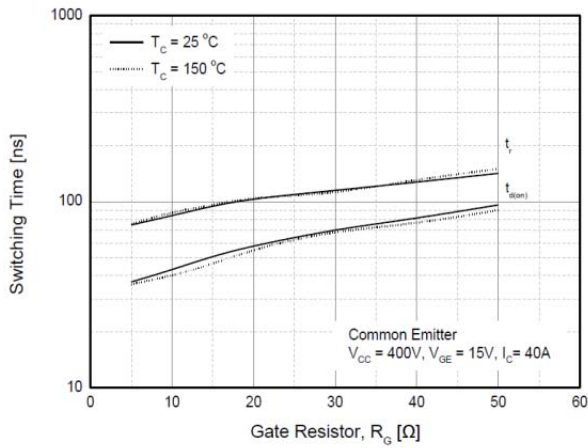

Fig. 8 Turn-off time vs. gate resistor

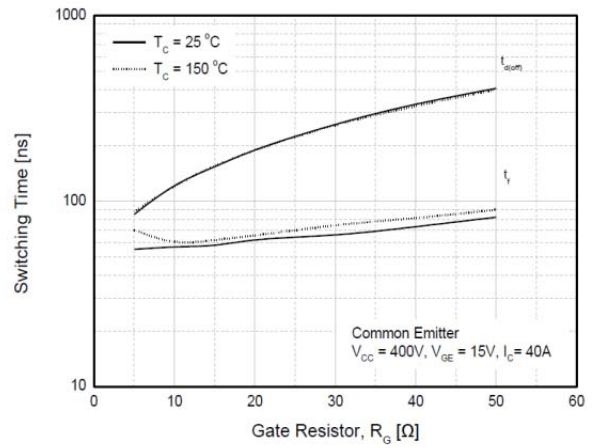

Fig. 9 Switching loss vs. gate resistor

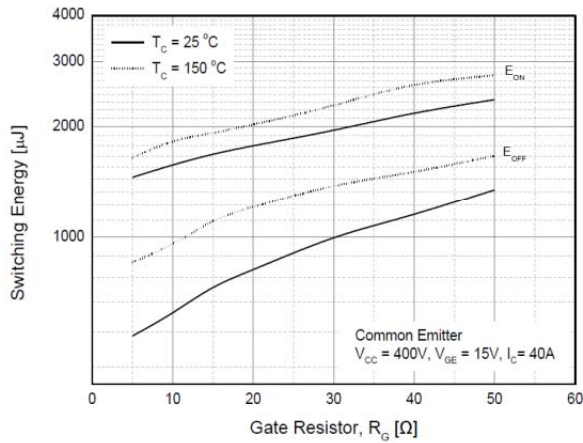

Fig. 10 Turn-on time vs. collector current

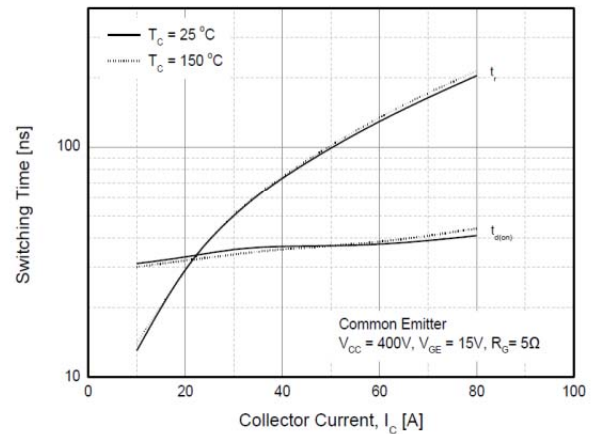

Fig. 11 Turn-off time vs. collector current

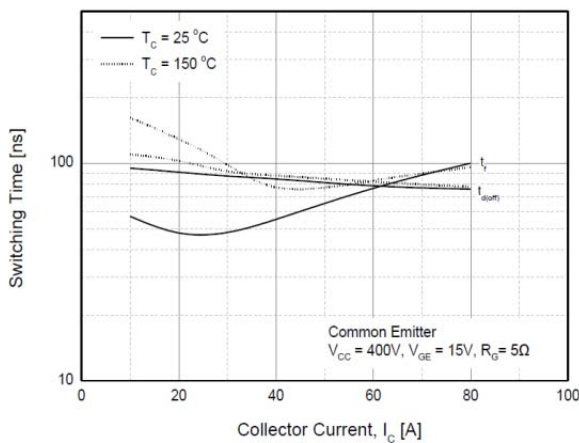

Fig. 12 Switching loss vs. collector current

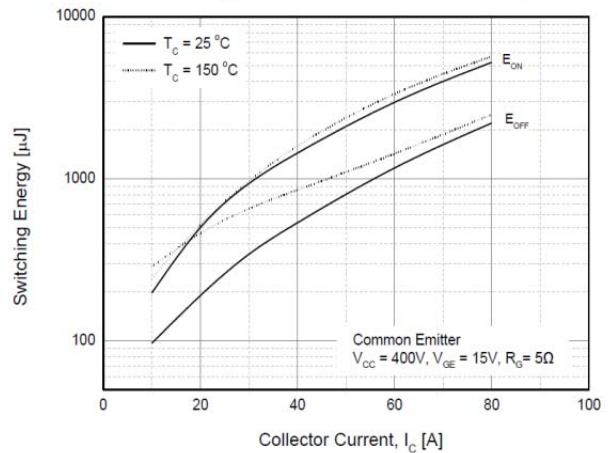

Fig. 13 Gate charge characteristics

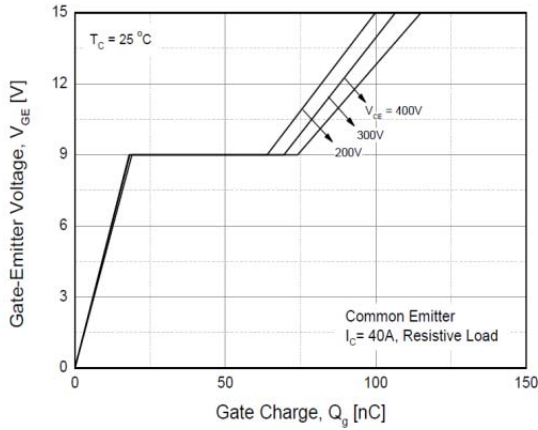

Fig. 14 SOA

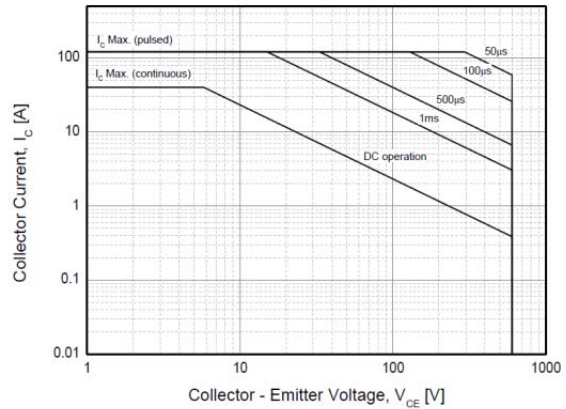

Fig. 15 RBSOA

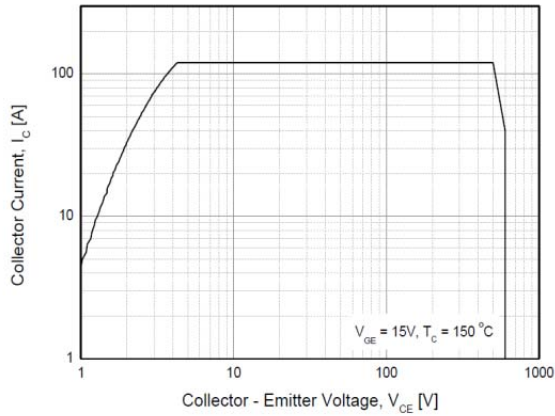
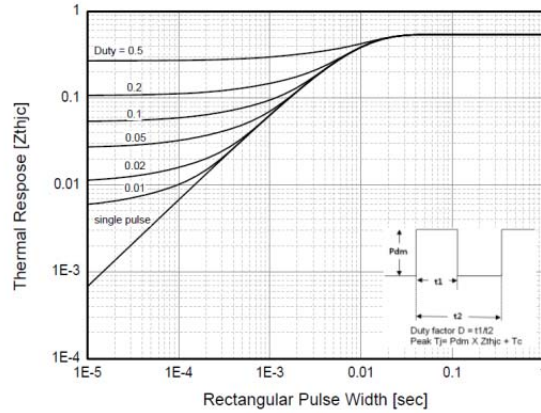

Fig. 16 Transient thermal impedance of IGBT



Buck SiC Diode Characteristics

Fig. 17 Forward Characteristics

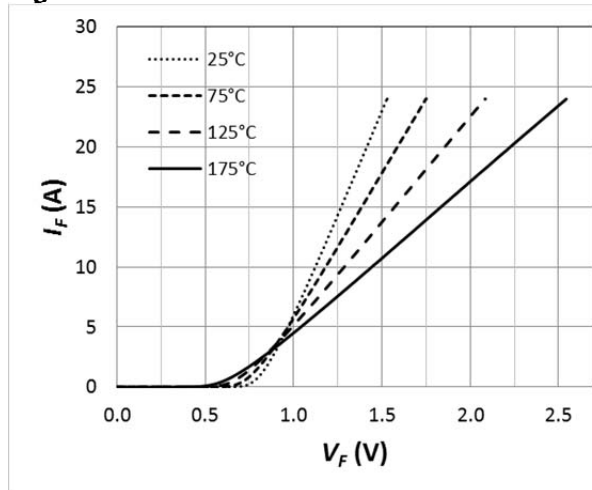

Fig. 18 Reverse Characteristics

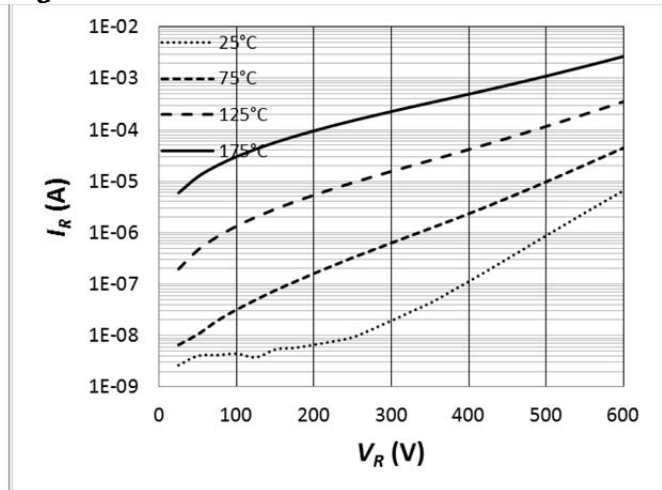

Fig. 19 Power Derating

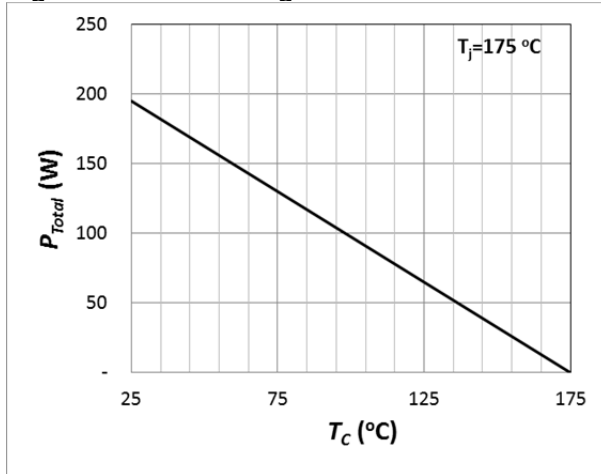

Fig. 20 Current Derating

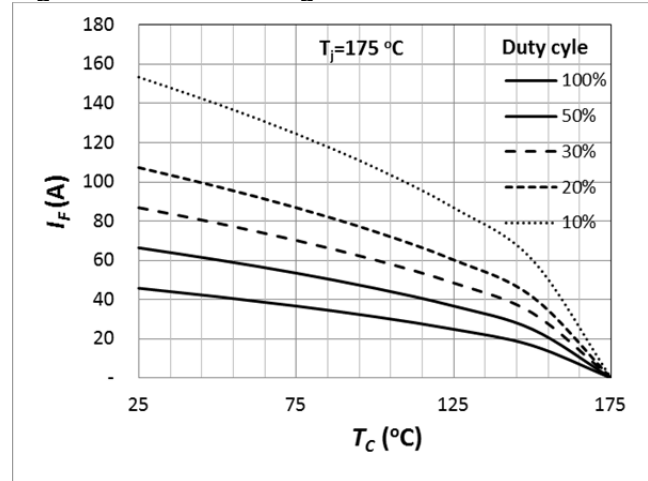

Fig. 21 Capacitance Curve

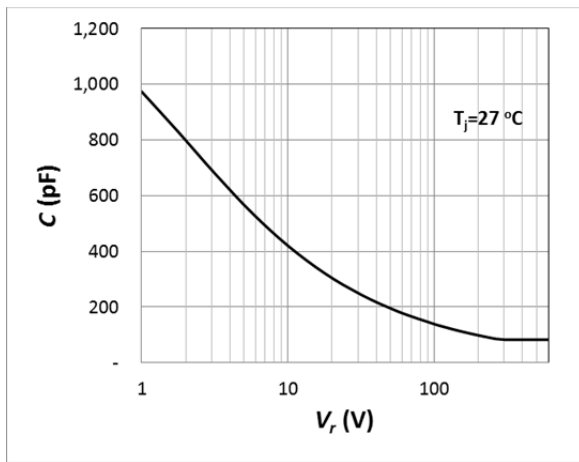
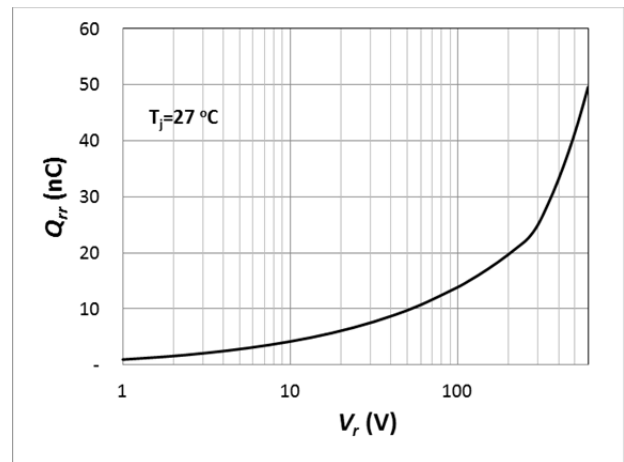
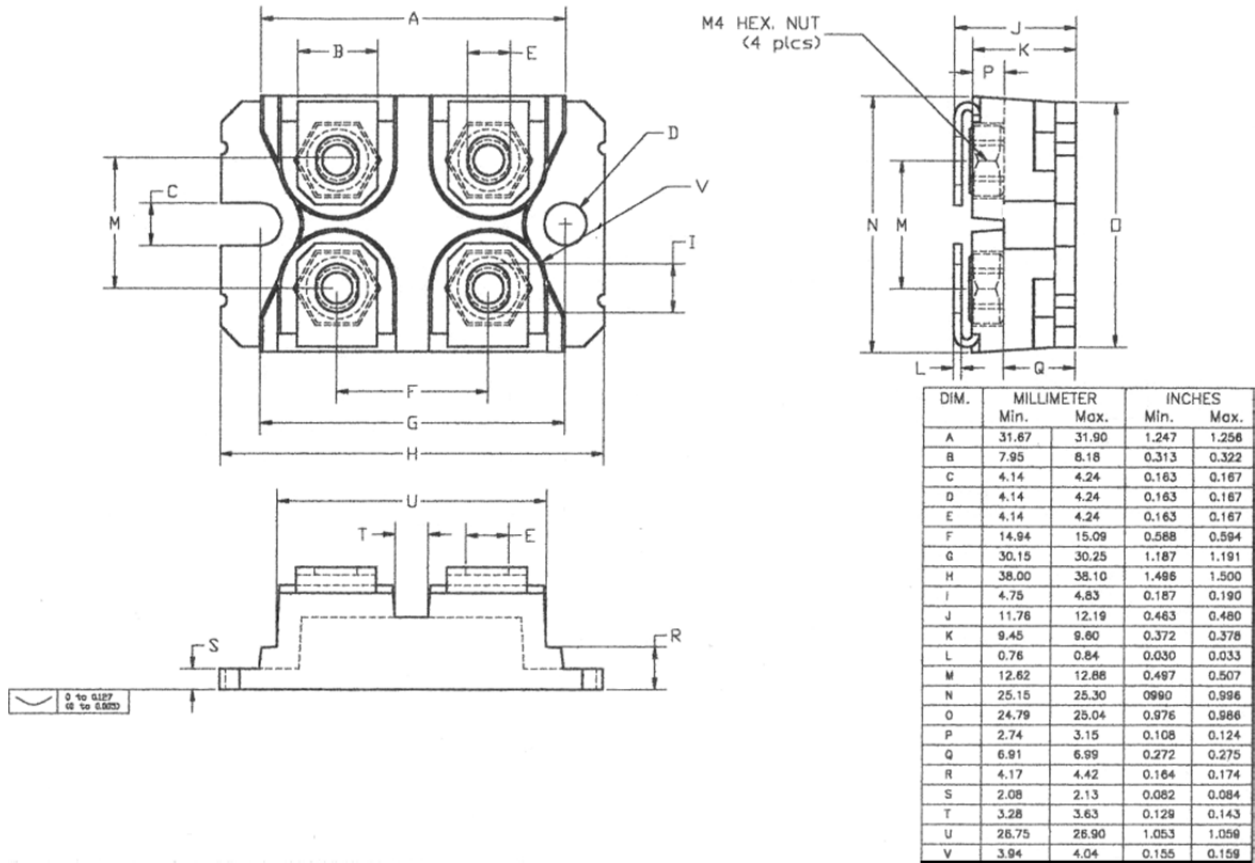

Fig. 22 Recovery Charge



SOT-227 Package Outline



Revision History

Date	Revision	Notes
6/3/2014	1.0	Initial release

Global Power Technologies Group

20692 Prism Place
 Lake Forest, CA 92630
 TEL (949) 207-7500
 FAX (949) 613-7600
 E-mail: info@gptechnology.com
 Web site: www.gptechnology.com



Notes

- **RoHS Compliance**

The levels of RoHS restricted materials in this product are below the maximum concentration values (also referred to as the threshold limits) permitted for such substances, or are used in an exempted application, in accordance with EU Directive 2011/65/EC (RoHS2), as implemented March, 2013. RoHS Declarations for this product can be obtained from the Product Documentation sections of www.gptechgroup.com.

- **REACH Compliance**

REACH substances of high concern (SVHCs) information is available for this product. Since the European Chemical Agency (ECHA) has published notice of their intent to frequently revise the SVHC listing for the foreseeable future, please contact our office at GPTG Headquarters in Lake Forest, California to insure you get the most up-to-date REACH SVHC Declaration.

REACH banned substance information (REACH Article 67) is also available upon request.

- This product has not been designed or tested for use in, and is not intended for use in, applications implanted into the human body nor in applications in which failure of the product could lead to death, personal injury or property damage, including but not limited to equipment used in the operation of nuclear facilities, life-support machines, cardiac defibrillators or similar emergency medical equipment, aircraft navigation or communication or control systems, or air traffic control.

- To obtain additional technical information or to place an order for this product, please contact us. The information in this datasheet is provided by Global Power Technologies Group. GPTG reserves the right to make changes, corrections, modifications, and improvements of datasheet without notice.