

## IGBT

IGBT with integrated diode in packages offering space saving advantage

## IKD10N60RFA

TRENCHSTOP™ RC-Series for hard switching applications up to 30 kHz

Data sheet

IGBT with integrated diode in packages offering space saving advantage

**Features:**

TRENCHSTOP™ Reverse Conducting (RC) technology for 600V applications offering

- Optimized Eon, Eoff and Qrr for low switching losses
- Operating range of 4 to 30kHz
- Smooth switching performance leading to low EMI levels
- Very tight parameter distribution
- Maximum junction temperature 175°C
- Short circuit capability of 5µs
- Best in class current versus package size performance
- Qualified according to AEC-Q101
- Pb-free lead plating; RoHS compliant (solder temperature 260°C, MSL1)

Complete product spectrum and PSpice Models:  
<http://www.infineon.com/igbt/>

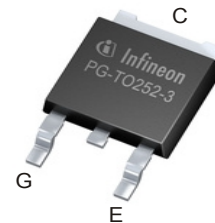
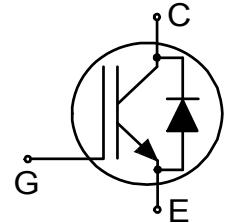

**Applications:**

- Small drives
- Piezo injection
- Automotive lighting / HID



**Key Performance and Package Parameters**

Type	V <sub>CE</sub>	I <sub>C</sub>	V <sub>CEsat</sub> , T <sub>vj</sub> =25°C	T <sub>vjmax</sub>	Marking	Package
IKD10N60RFA	600V	10A	2.2V	175°C	K10DRFA	PG-TO252-3



**Table of Contents**

Description ..... 2

Table of Contents ..... 3

Maximum Ratings ..... 4

Thermal Resistance ..... 4

Electrical Characteristics ..... 5

Electrical Characteristics Diagrams ..... 8

Package Drawing .....15

Testing Conditions .....16

Revision History .....17

Disclaimer .....17

**Maximum Ratings**

For optimum lifetime and reliability, Infineon recommends operating conditions that do not exceed 80% of the maximum ratings stated in this datasheet.

Parameter	Symbol	Value	Unit
Collector-emitter voltage, $T_{vj} \geq 25^{\circ}\text{C}$	$V_{CE}$	600	V
DC collector current, limited by $T_{vjmax}$ $T_C = 25^{\circ}\text{C}$ $T_C = 100^{\circ}\text{C}$	$I_C$	20.0 10.0	A
Pulsed collector current, $t_p$ limited by $T_{vjmax}^{1)}$	$I_{Cpuls}$	30.0	A
Turn off safe operating area $V_{CE} \leq 600\text{V}$ , $T_{vj} \leq 175^{\circ}\text{C}$ , $t_p = 1\mu\text{s}^{1)}$	-	30.0	A
Diode forward current, limited by $T_{vjmax}$ $T_C = 25^{\circ}\text{C}$ $T_C = 100^{\circ}\text{C}$	$I_F$	20.0 10.0	A
Diode pulsed current, $t_p$ limited by $T_{vjmax}^{1)}$	$I_{Fpuls}$	30.0	A
Gate-emitter voltage	$V_{GE}$	$\pm 20$	V
Short circuit withstand time $V_{GE} = 15.0\text{V}$ , $V_{CC} \leq 400\text{V}$ Allowed number of short circuits < 1000 Time between short circuits: $\geq 1.0\text{s}$ $T_{vj} = 150^{\circ}\text{C}$	$t_{SC}$	5	$\mu\text{s}$
Power dissipation $T_C = 25^{\circ}\text{C}$	$P_{tot}$	150.0	W
Operating junction temperature	$T_{vj}$	-40...+175	$^{\circ}\text{C}$
Storage temperature	$T_{stg}$	-55...+150	$^{\circ}\text{C}$
Soldering temperature, reflow soldering (MSL1 according to JEDEC J-STA-020)		260	$^{\circ}\text{C}$

**Thermal Resistance**

Parameter	Symbol	Conditions	Max. Value	Unit
<b>Characteristic</b>				
IGBT thermal resistance, <sup>2)</sup> junction - case	$R_{th(j-c)}$		1.00	K/W
Diode thermal resistance, <sup>3)</sup> junction - case	$R_{th(j-c)}$		2.60	K/W
Thermal resistance, min. footprint junction - ambient	$R_{th(j-a)}$		75	K/W
Thermal resistance, 6cm <sup>2</sup> Cu on PCB junction - ambient	$R_{th(j-a)}$		50	K/W

<sup>1)</sup> Defined by design. Not subject to production test.

<sup>2)</sup> Rth/Zth based on single cooling pulse. Please be aware that a correct Rth measurement of the IGBT, is not possible using a thermocouple.

<sup>3)</sup> Rth/Zth based on single cooling pulse. Please be aware that a correct Rth measurement of the Diode, is not possible using a thermocouple.

**Electrical Characteristic, at  $T_{vj} = 25^{\circ}\text{C}$ , unless otherwise specified**

Parameter	Symbol	Conditions	Value			Unit
			min.	typ.	max.	
<b>Static Characteristic</b>						
Collector-emitter breakdown voltage	$V_{(BR)CES}$	$V_{GE} = 0\text{V}, I_C = 0.20\text{mA}$	600	-	-	V
Collector-emitter saturation voltage	$V_{CESat}$	$V_{GE} = 15.0\text{V}, I_C = 10.0\text{A}$ $T_{vj} = 25^{\circ}\text{C}$ $T_{vj} = 175^{\circ}\text{C}$	- -	2.20 2.30	2.50 -	V
Diode forward voltage	$V_F$	$V_{GE} = 0\text{V}, I_F = 10.0\text{A}$ $T_{vj} = 25^{\circ}\text{C}$ $T_{vj} = 175^{\circ}\text{C}$	- -	2.10 2.00	2.40 -	V
Gate-emitter threshold voltage	$V_{GE(th)}$	$I_C = 0.17\text{mA}, V_{CE} = V_{GE}$	4.3	5.0	5.7	V
Zero gate voltage collector current	$I_{CES}$	$V_{CE} = 600\text{V}, V_{GE} = 0\text{V}$ $T_{vj} = 25^{\circ}\text{C}$ $T_{vj} = 175^{\circ}\text{C}$	- -	- 440.0	40.0 -	$\mu\text{A}$
Gate-emitter leakage current	$I_{GES}$	$V_{CE} = 0\text{V}, V_{GE} = 20\text{V}$	-	-	100	nA
Transconductance <sup>1)</sup>	$g_{fs}$	$V_{CE} = 10\text{V}, I_C = 10.0\text{A}$	-	4.6	-	S
Integrated gate resistor	$r_G$			none		$\Omega$

**Electrical Characteristic, at  $T_{vj} = 25^{\circ}\text{C}$ , unless otherwise specified**

Parameter	Symbol	Conditions	Value			Unit
			min.	typ.	max.	
<b>Dynamic Characteristic</b>						
Input capacitance	$C_{ies}$		-	655	-	pF
Output capacitance	$C_{oes}$	$V_{CE} = 25\text{V}, V_{GE} = 0\text{V}, f = 1\text{MHz}$	-	37	-	
Reverse transfer capacitance	$C_{res}$		-	22	-	
Gate charge	$Q_G$	$V_{CC} = 480\text{V}, I_C = 10.0\text{A},$ $V_{GE} = 15\text{V}$	-	64.0	-	nC
Internal emitter inductance measured 5mm (0.197 in.) from case	$L_E$		-	7.0	-	nH
Short circuit collector current Max. 1000 short circuits Time between short circuits: $\geq 1.0\text{s}$	$I_{C(SC)}$	$V_{GE} = 15.0\text{V}, V_{CC} \leq 400\text{V},$ $t_{SC} \leq 5\mu\text{s}$ $T_{vj} = 25^{\circ}\text{C}$	-	74	-	A

<sup>1)</sup> Typical value of transconductance determined at  $T_{vj}=175^{\circ}\text{C}$ .

**Switching Characteristic, Inductive Load**

Parameter	Symbol	Conditions	Value			Unit
			min.	typ.	max.	
<b>IGBT Characteristic, at <math>T_{vj} = 25^{\circ}\text{C}</math></b>						
Turn-on delay time	$t_{d(on)}$	$T_{vj} = 25^{\circ}\text{C}$ , $V_{CC} = 400\text{V}$ , $I_C = 10.0\text{A}$ , $V_{GE} = 0.0/15.0\text{V}$ , $R_{G(on)} = 26.0\Omega$ , $R_{G(off)} = 26.0\Omega$ , $L\sigma = 50\text{nH}$ , $C\sigma = 30\text{pF}$ $L\sigma$ , $C\sigma$ from Fig. E	-	12	-	ns
Rise time	$t_r$		-	15	-	ns
Turn-off delay time	$t_{d(off)}$		-	168	-	ns
Fall time	$t_f$		-	18	-	ns
Turn-on energy	$E_{on}$		-	0.19	-	mJ
Turn-off energy	$E_{off}$		-	0.16	-	mJ
Total switching energy	$E_{ts}$		-	0.35	-	mJ

**Diode Characteristic, at  $T_{vj} = 25^{\circ}\text{C}$** 

Diode reverse recovery time	$t_{rr}$	$T_{vj} = 25^{\circ}\text{C}$ , $V_R = 400\text{V}$ , $I_F = 10.0\text{A}$ , $di_F/dt = 750\text{A}/\mu\text{s}$	-	72	-	ns
Diode reverse recovery charge	$Q_{rr}$		-	0.27	-	$\mu\text{C}$
Diode peak reverse recovery current	$I_{rrm}$		-	9.1	-	A
Diode peak rate of fall of reverse recovery current during $t_b$	$di_{rr}/dt$		-	-146	-	$\text{A}/\mu\text{s}$

**Switching Characteristic, Inductive Load**

Parameter	Symbol	Conditions	Value			Unit
			min.	typ.	max.	
<b>IGBT Characteristic, at <math>T_{vj} = 175^{\circ}\text{C}</math></b>						
Turn-on delay time	$t_{d(on)}$	$T_{vj} = 175^{\circ}\text{C}$ , $V_{CC} = 400\text{V}$ , $I_C = 10.0\text{A}$ , $V_{GE} = 0.0/15.0\text{V}$ , $R_{G(on)} = 26.0\Omega$ , $R_{G(off)} = 26.0\Omega$ , $L\sigma = 50\text{nH}$ , $C\sigma = 30\text{pF}$ $L\sigma$ , $C\sigma$ from Fig. E	-	12	-	ns
Rise time	$t_r$		-	15	-	ns
Turn-off delay time	$t_{d(off)}$		-	178	-	ns
Fall time	$t_f$		-	20	-	ns
Turn-on energy	$E_{on}$		-	0.31	-	mJ
Turn-off energy	$E_{off}$		-	0.21	-	mJ
Total switching energy	$E_{ts}$		-	0.52	-	mJ

**Diode Characteristic, at  $T_{vj} = 175^{\circ}\text{C}$** 

Diode reverse recovery time	$t_{rr}$	$T_{vj} = 175^{\circ}\text{C}$ , $V_R = 400\text{V}$ , $I_F = 10.0\text{A}$ , $di_F/dt = 720\text{A}/\mu\text{s}$	-	112	-	ns
Diode reverse recovery charge	$Q_{rr}$		-	0.62	-	$\mu\text{C}$
Diode peak reverse recovery current	$I_{rrm}$		-	12.9	-	A
Diode peak rate of fall of reverse recovery current during $t_b$	$di_{rr}/dt$		-	-136	-	$\text{A}/\mu\text{s}$

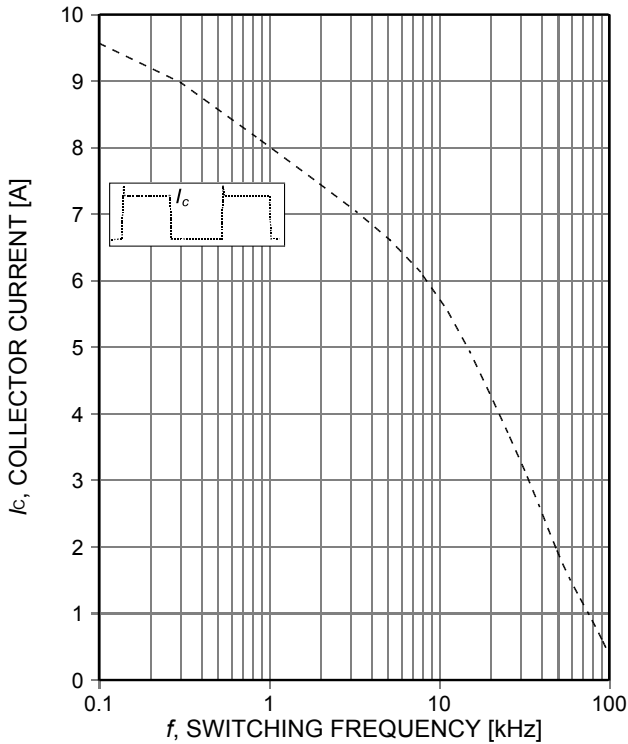

Figure 1. **Collector current as a function of switching frequency**  
 ( $T_{vj} \leq 175^\circ\text{C}$ ,  $T_a = 55^\circ\text{C}$ ,  $D = 0.5$ ,  $V_{CE} = 400\text{V}$ ,  $V_{GE} = 15/0\text{V}$ ,  $r_G = 26\Omega$ , PCB mounting with thermal vias and heatsink, see Appnote: [www.infineon.com/igbt](http://www.infineon.com/igbt))

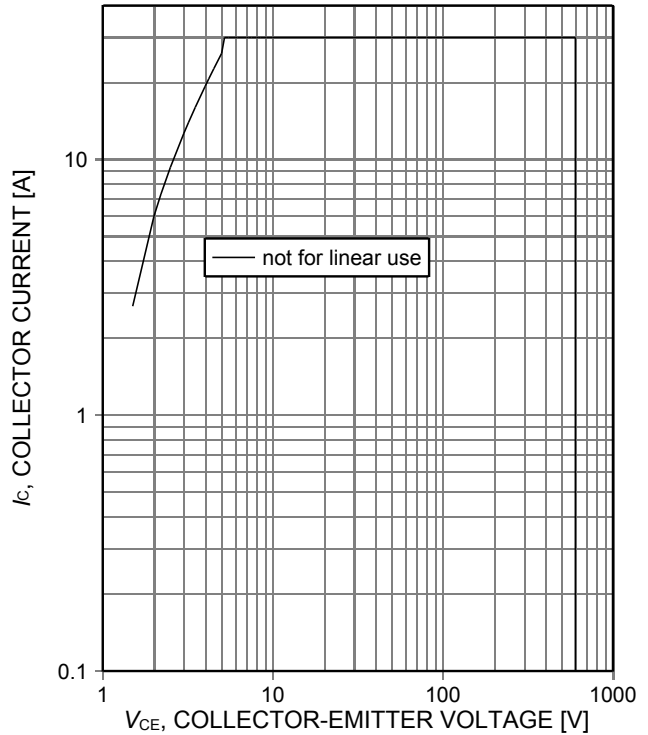

Figure 2. **Forward bias safe operating area**  
 ( $D = 0$ ,  $T_C = 25^\circ\text{C}$ ,  $T_{vj} \leq 175^\circ\text{C}$ ,  $V_{GE} = 15\text{V}$ ,  $t_p = 1\mu\text{s}$ )

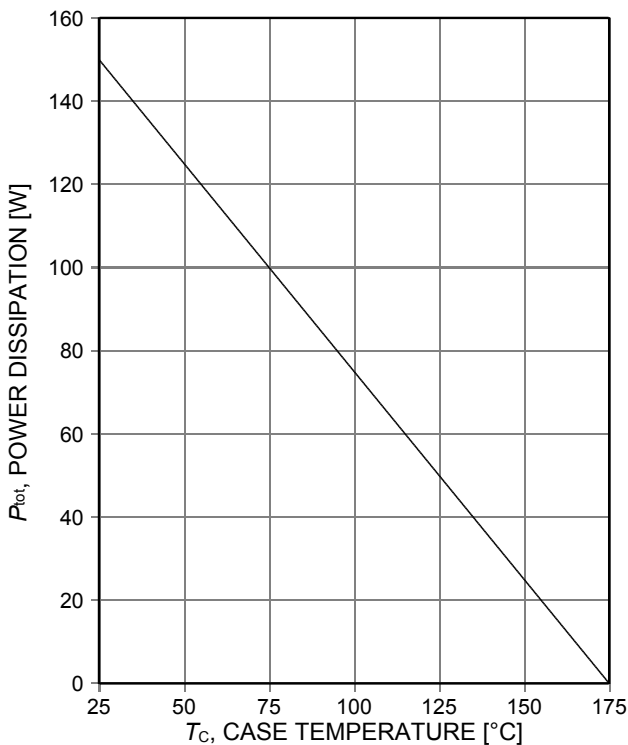

Figure 3. **Power dissipation as a function of case temperature**  
 ( $T_{vj} \leq 175^\circ\text{C}$ )

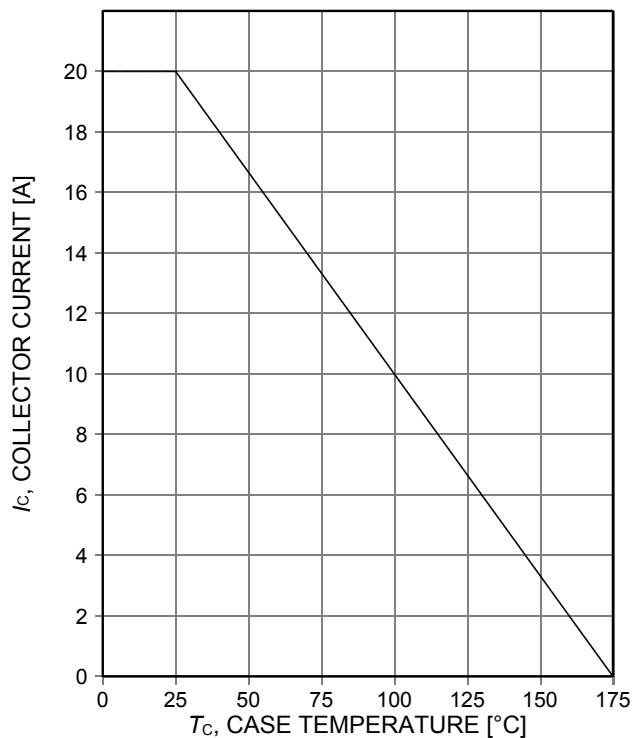

Figure 4. **Collector current as a function of case temperature**  
 ( $V_{GE} \geq 15\text{V}$ ,  $T_{vj} \leq 175^\circ\text{C}$ )

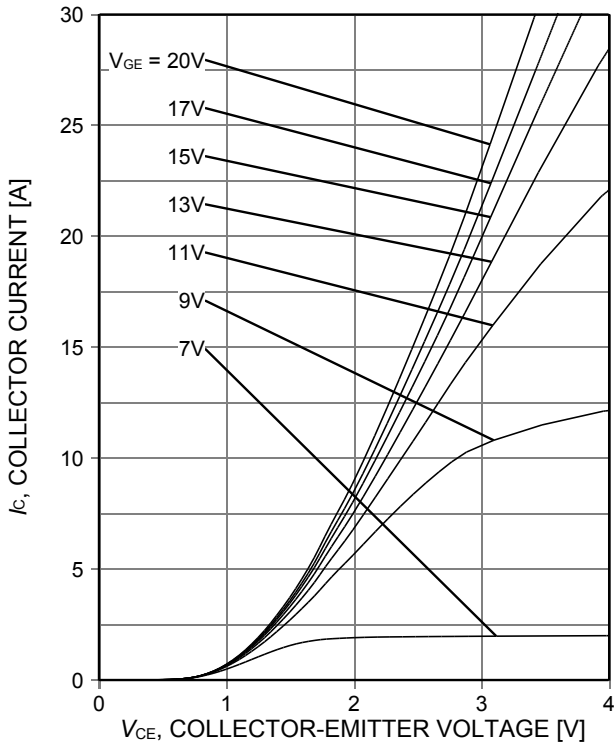

Figure 5. **Typical output characteristic**  
( $T_{vj}=25^{\circ}\text{C}$ )

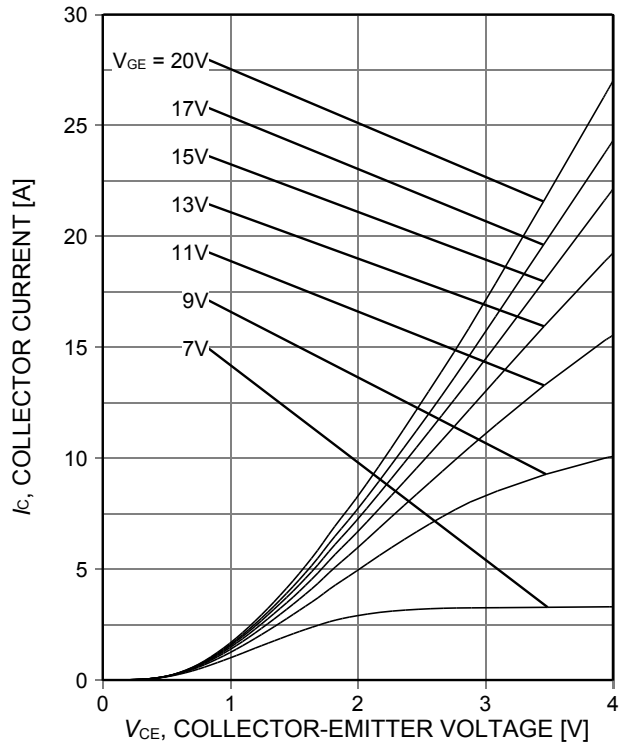

Figure 6. **Typical output characteristic**  
( $T_{vj}=175^{\circ}\text{C}$ )

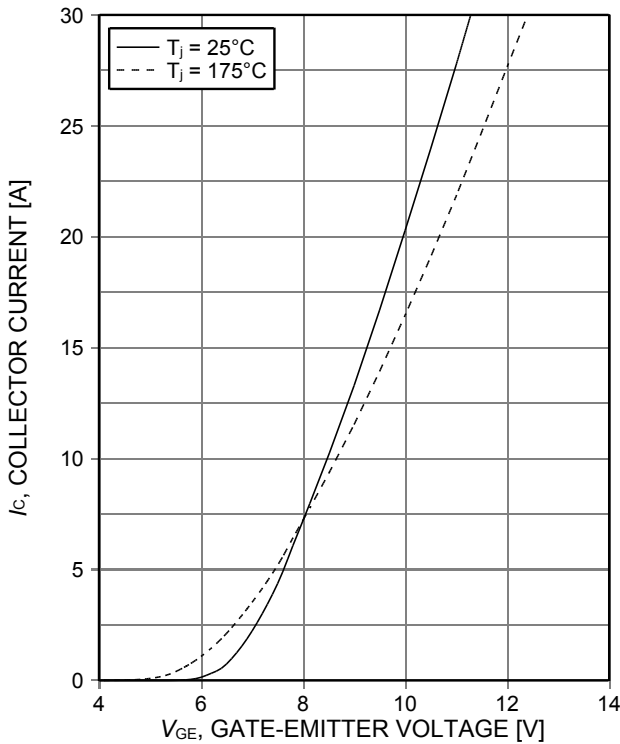

Figure 7. **Typical transfer characteristic**  
( $V_{ce}=10\text{V}$ )

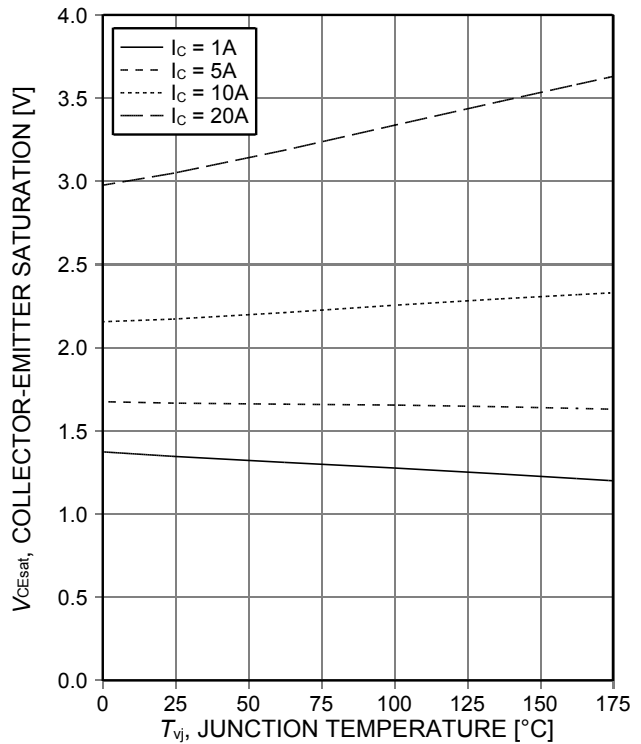

Figure 8. **Typical collector-emitter saturation voltage as a function of junction temperature**  
( $V_{ge}=15\text{V}$ )



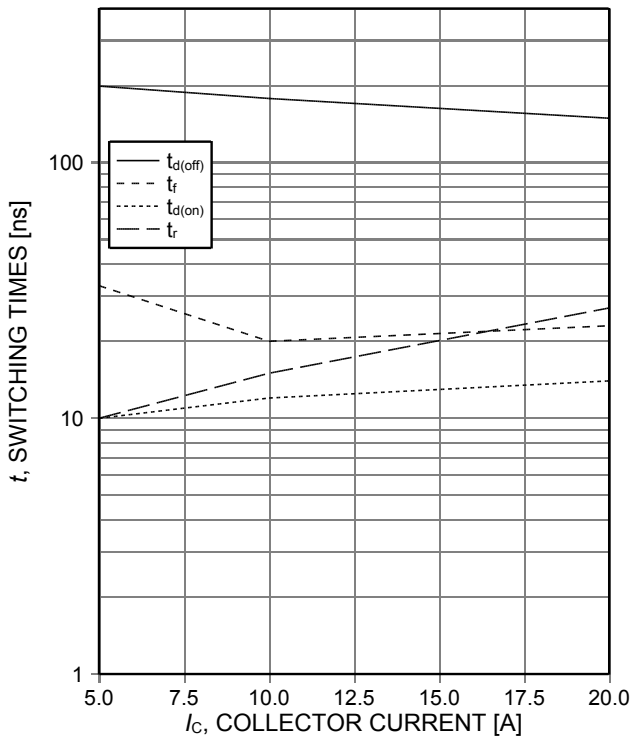

Figure 9. **Typical switching times as a function of collector current**  
 (inductive load,  $T_{vj}=175^{\circ}\text{C}$ ,  $V_{CE}=400\text{V}$ ,  $V_{GE}=15/0\text{V}$ ,  $r_G=26\Omega$ , Dynamic test circuit in Figure E)

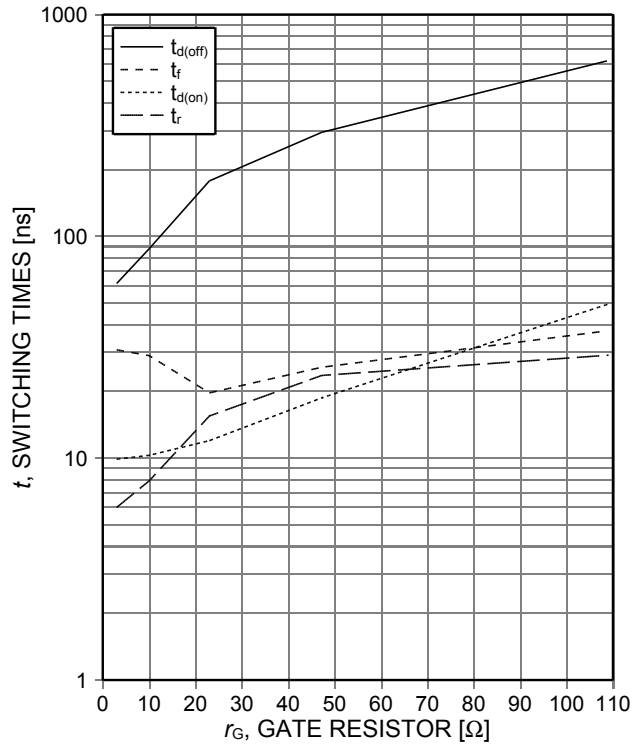

Figure 10. **Typical switching times as a function of gate resistor**  
 (inductive load,  $T_{vj}=175^{\circ}\text{C}$ ,  $V_{CE}=400\text{V}$ ,  $V_{GE}=15/0\text{V}$ ,  $I_C=10\text{A}$ , Dynamic test circuit in Figure E)

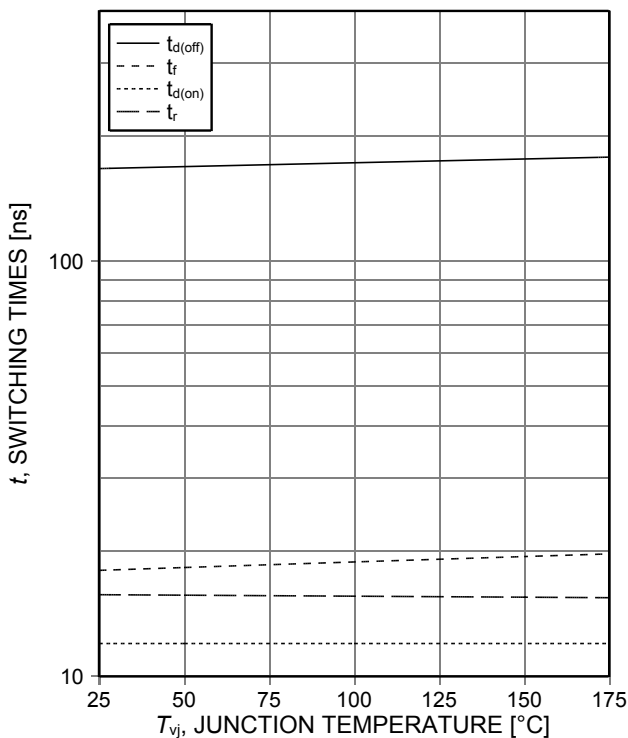

Figure 11. **Typical switching times as a function of junction temperature**  
 (inductive load,  $V_{CE}=400\text{V}$ ,  $V_{GE}=15/0\text{V}$ ,  $I_C=10\text{A}$ ,  $r_G=26\Omega$ , Dynamic test circuit in Figure E)

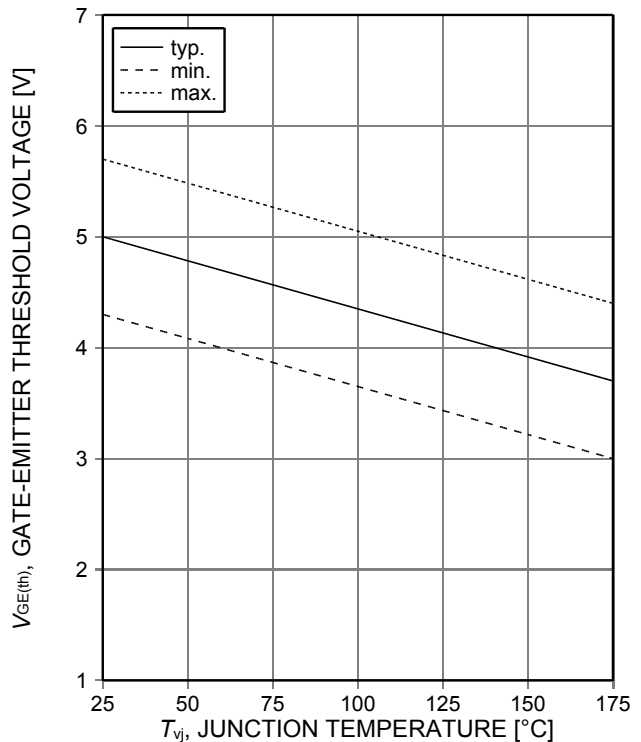

Figure 12. **Gate-emitter threshold voltage as a function of junction temperature**  
 ( $I_C=0, 17\text{mA}$ )

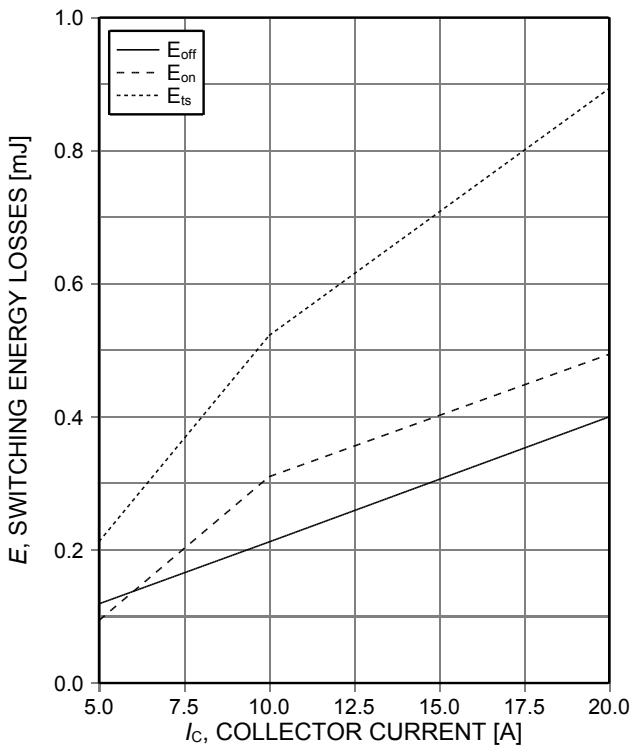

Figure 13. **Typical switching energy losses as a function of collector current**  
 (inductive load,  $T_{vj}=175^\circ\text{C}$ ,  $V_{CE}=400\text{V}$ ,  $V_{GE}=15/0\text{V}$ ,  $r_G=26\Omega$ , Dynamic test circuit in Figure E)

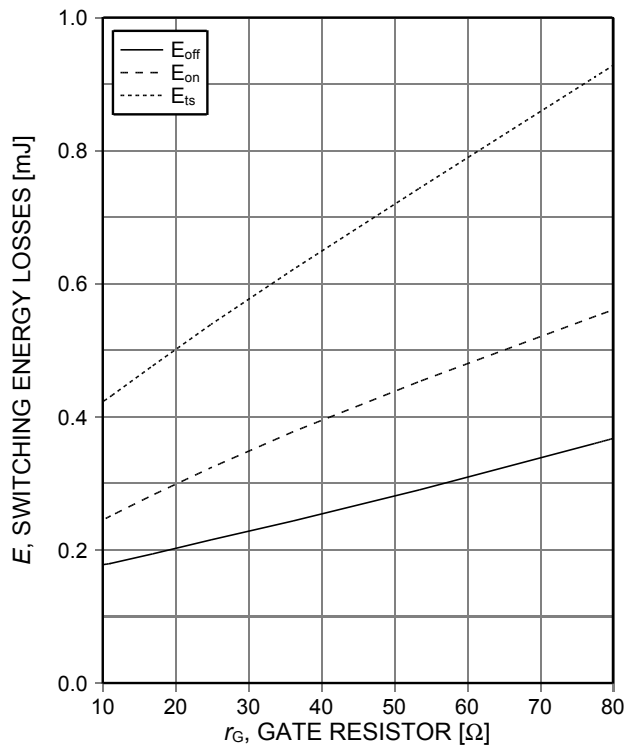

Figure 14. **Typical switching energy losses as a function of gate resistor**  
 (inductive load,  $T_{vj}=175^\circ\text{C}$ ,  $V_{CE}=400\text{V}$ ,  $V_{GE}=15/0\text{V}$ ,  $I_c=10\text{A}$ , Dynamic test circuit in Figure E)

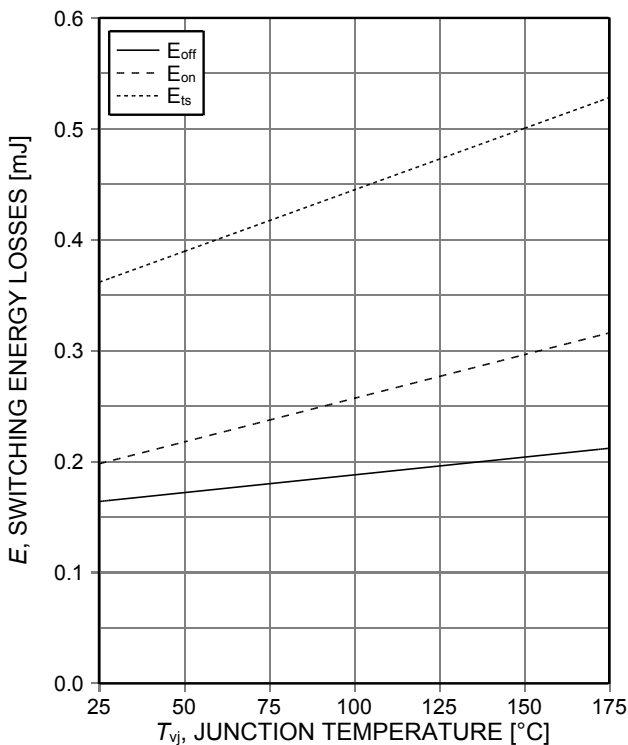

Figure 15. **Typical switching energy losses as a function of junction temperature**  
 (inductive load,  $V_{CE}=400\text{V}$ ,  $V_{GE}=15/0\text{V}$ ,  $I_c=10\text{A}$ ,  $r_G=26\Omega$ , Dynamic test circuit in Figure E)

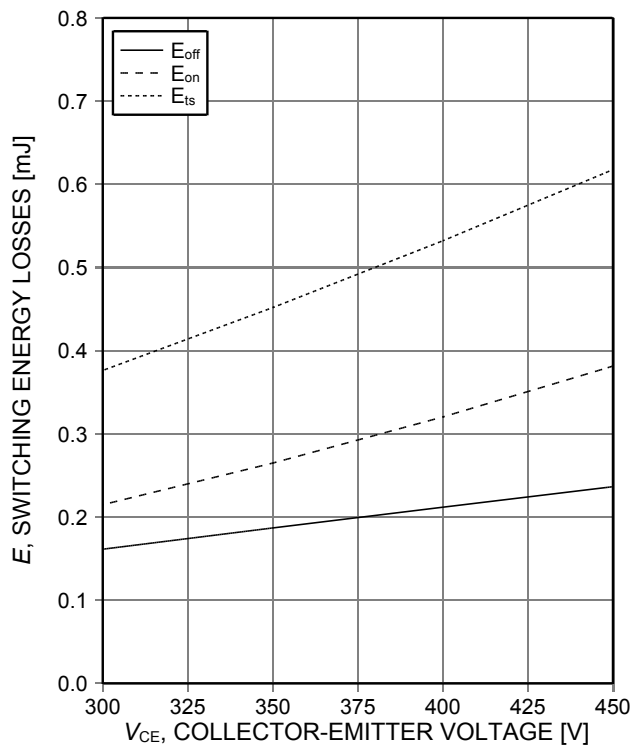

Figure 16. **Typical switching energy losses as a function of collector emitter voltage**  
 (inductive load,  $T_{vj}=175^\circ\text{C}$ ,  $V_{GE}=15/0\text{V}$ ,  $I_c=10\text{A}$ ,  $r_G=26\Omega$ , Dynamic test circuit in Figure E)

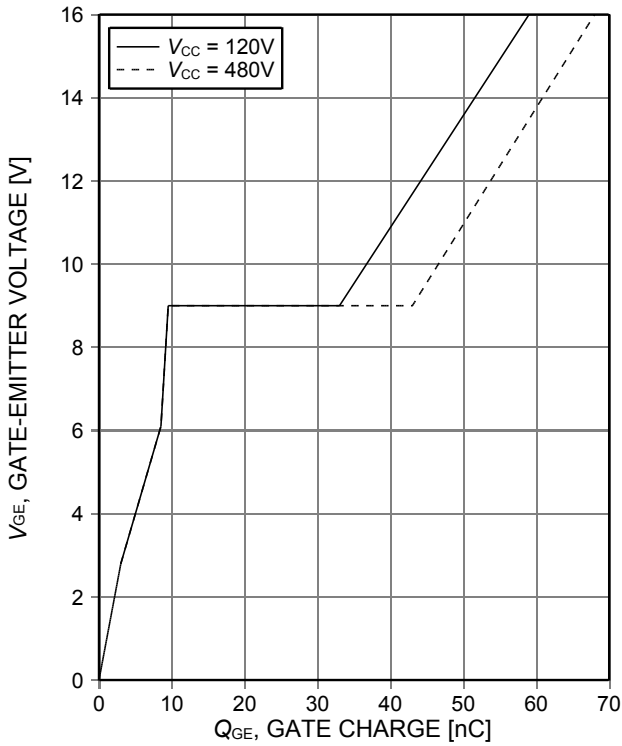

Figure 17. **Typical gate charge**  
( $I_C=10A$ )

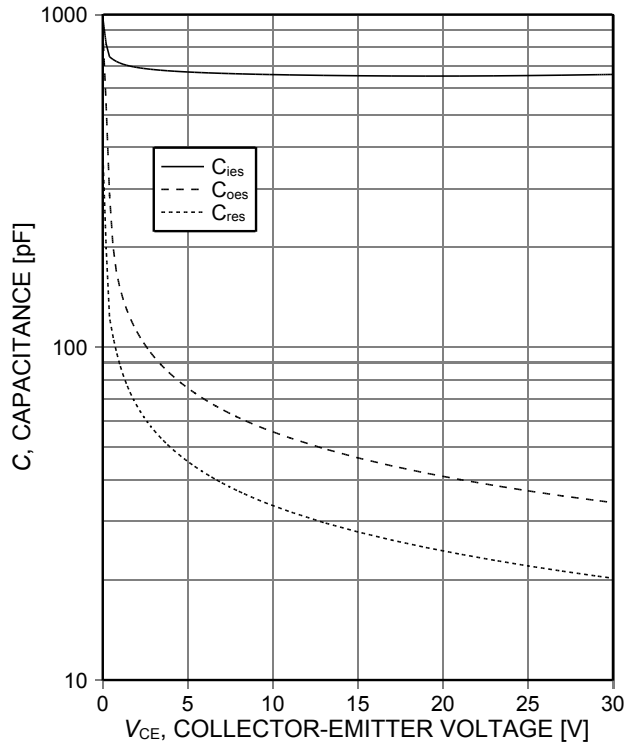

Figure 18. **Typical capacitance as a function of collector-emitter voltage**  
( $V_{GE}=0V$ ,  $f=1MHz$ )

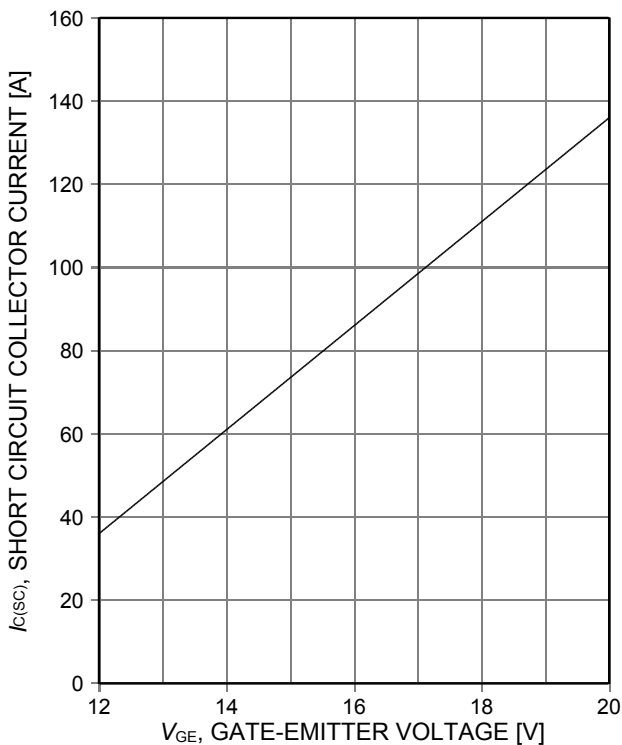

Figure 19. **Typical short circuit collector current as a function of gate-emitter voltage**  
( $V_{CE} \leq 400V$ , start at  $T_{vj}=25^\circ C$ )

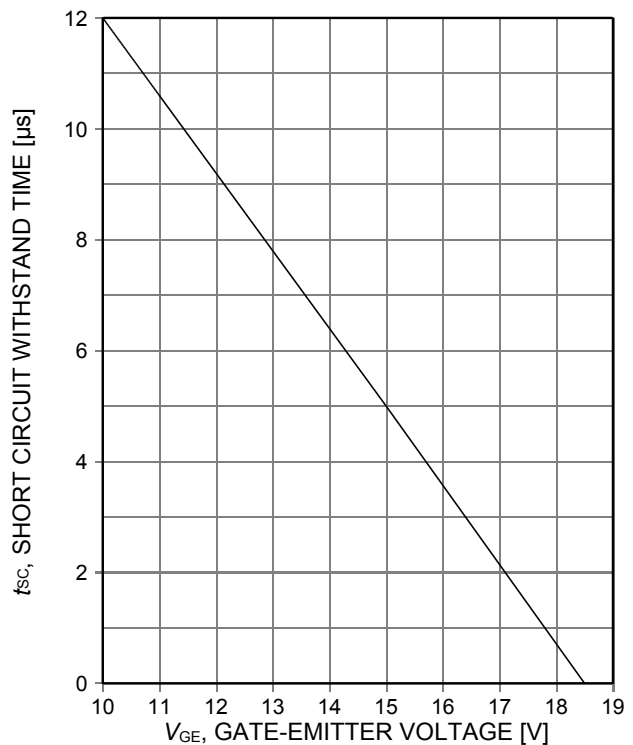

Figure 20. **Short circuit withstand time as a function of gate-emitter voltage**  
( $V_{CE} \leq 400V$ , start at  $T_{vj}=150^\circ C$ )

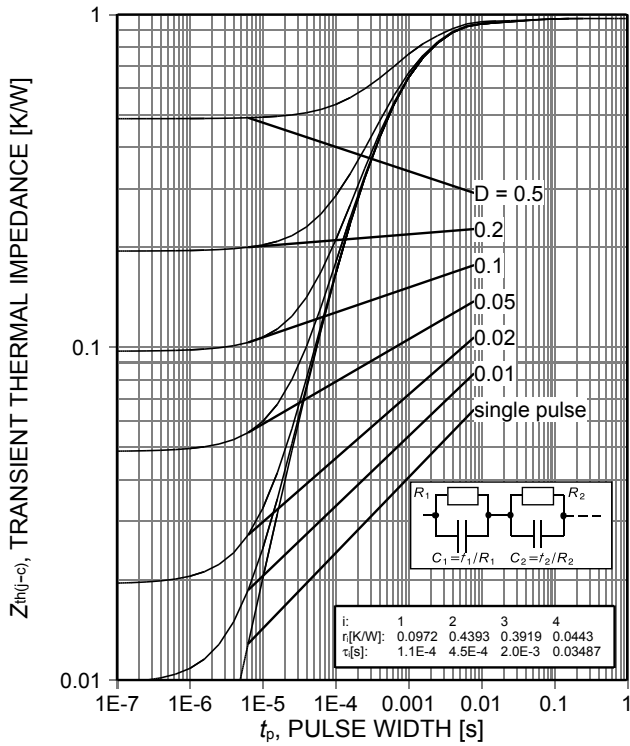

Figure 21. IGBT transient thermal impedance as a function of pulse width (see page 4<sup>2)</sup> ( $D=t_p/T$ )

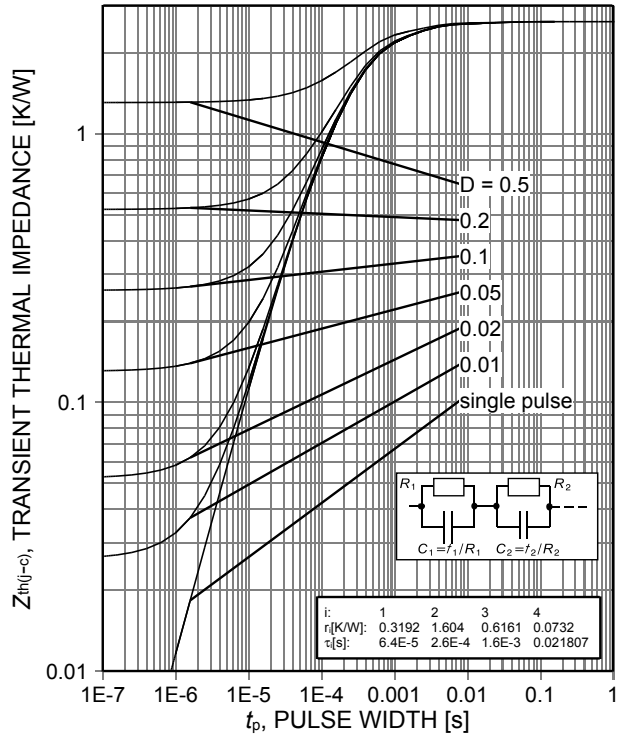

Figure 22. Diode transient thermal impedance as a function of pulse width (see page 4<sup>3)</sup> ( $D=t_p/T$ )

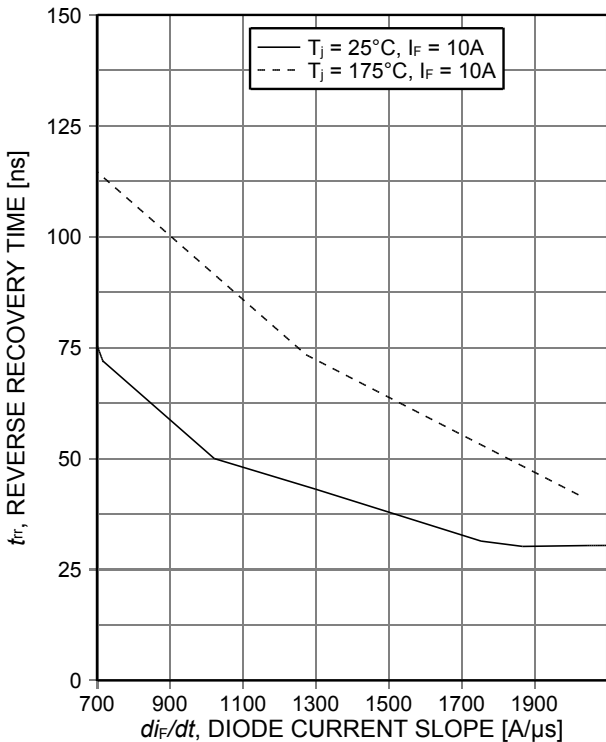

Figure 23. Typical reverse recovery time as a function of diode current slope ( $V_R=400V$ )

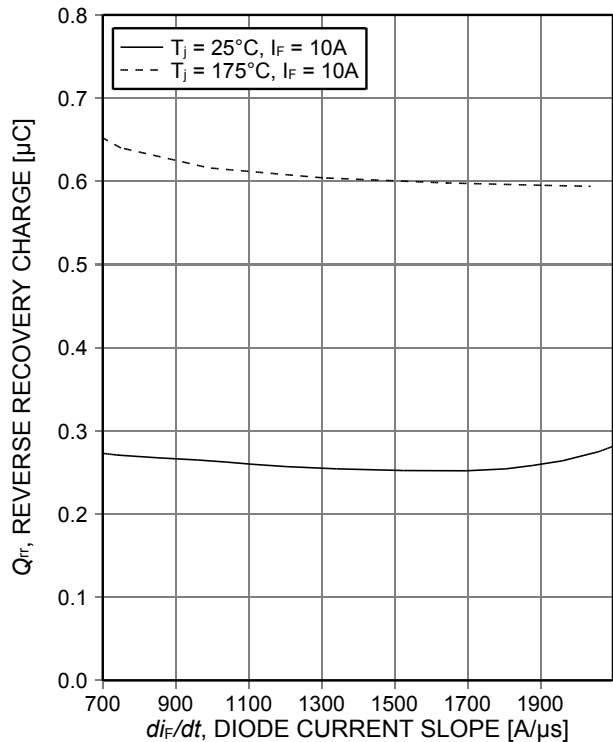

Figure 24. Typical reverse recovery charge as a function of diode current slope ( $V_R=400V$ )

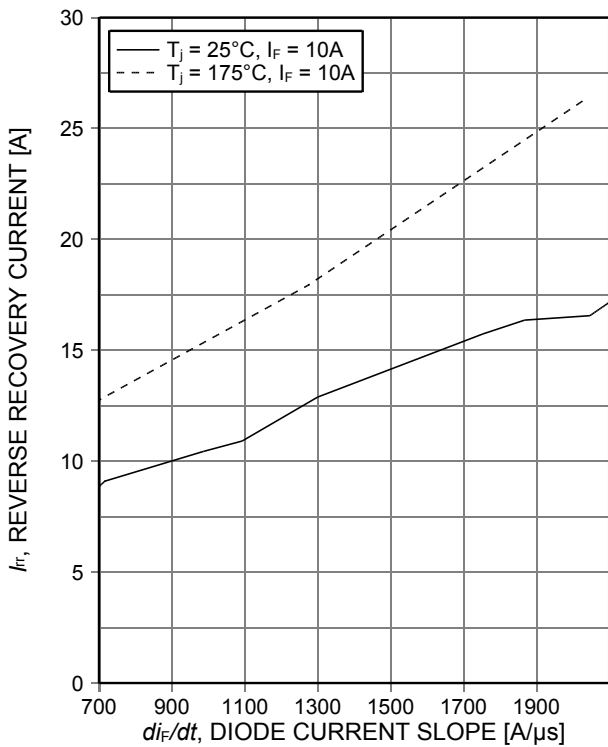

Figure 25. **Typical reverse recovery current as a function of diode current slope**  
( $V_R=400V$ )

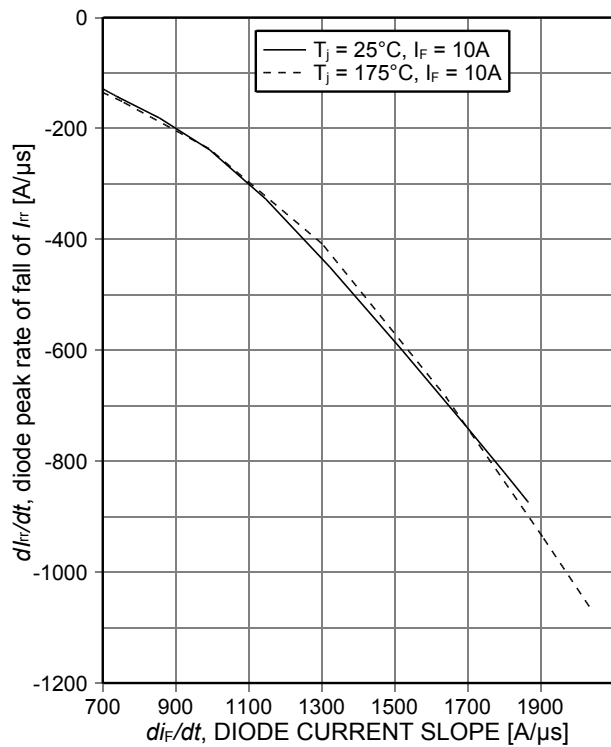

Figure 26. **Typical diode peak rate of fall of reverse recovery current as a function of diode current slope**  
( $V_R=400V$ )

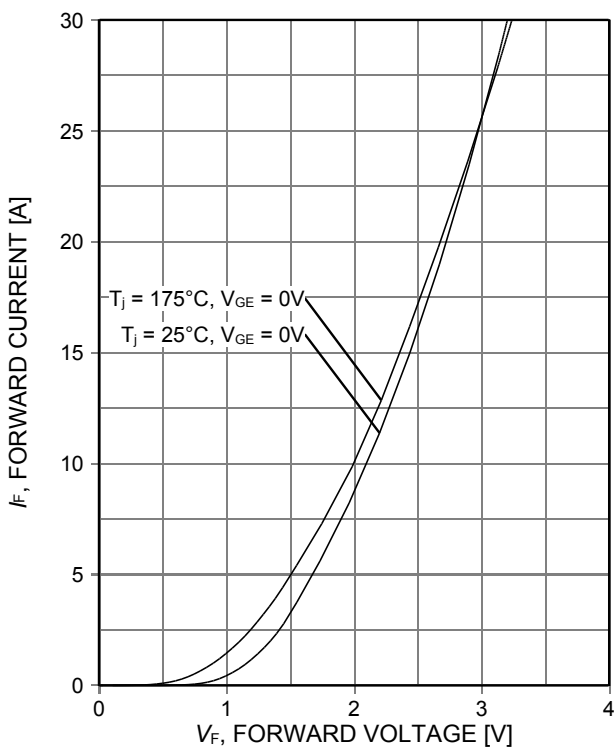

Figure 27. **Typical diode forward current as a function of forward voltage**

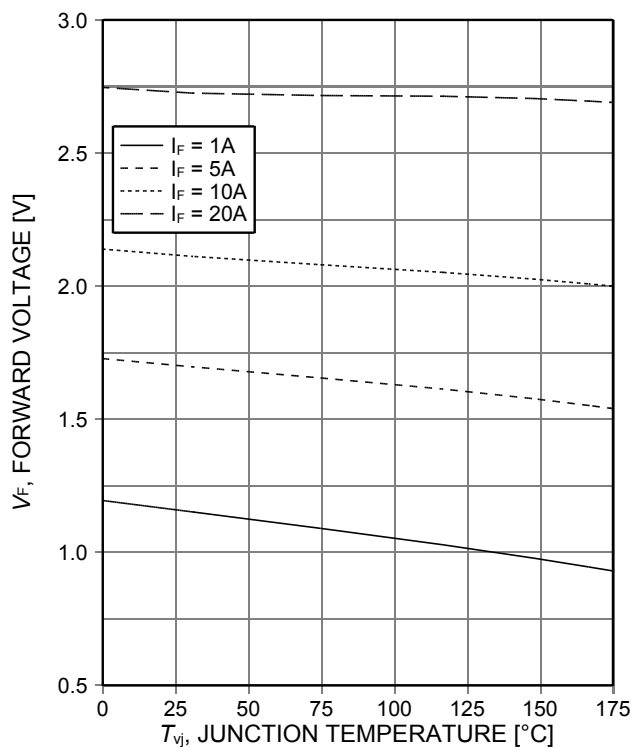
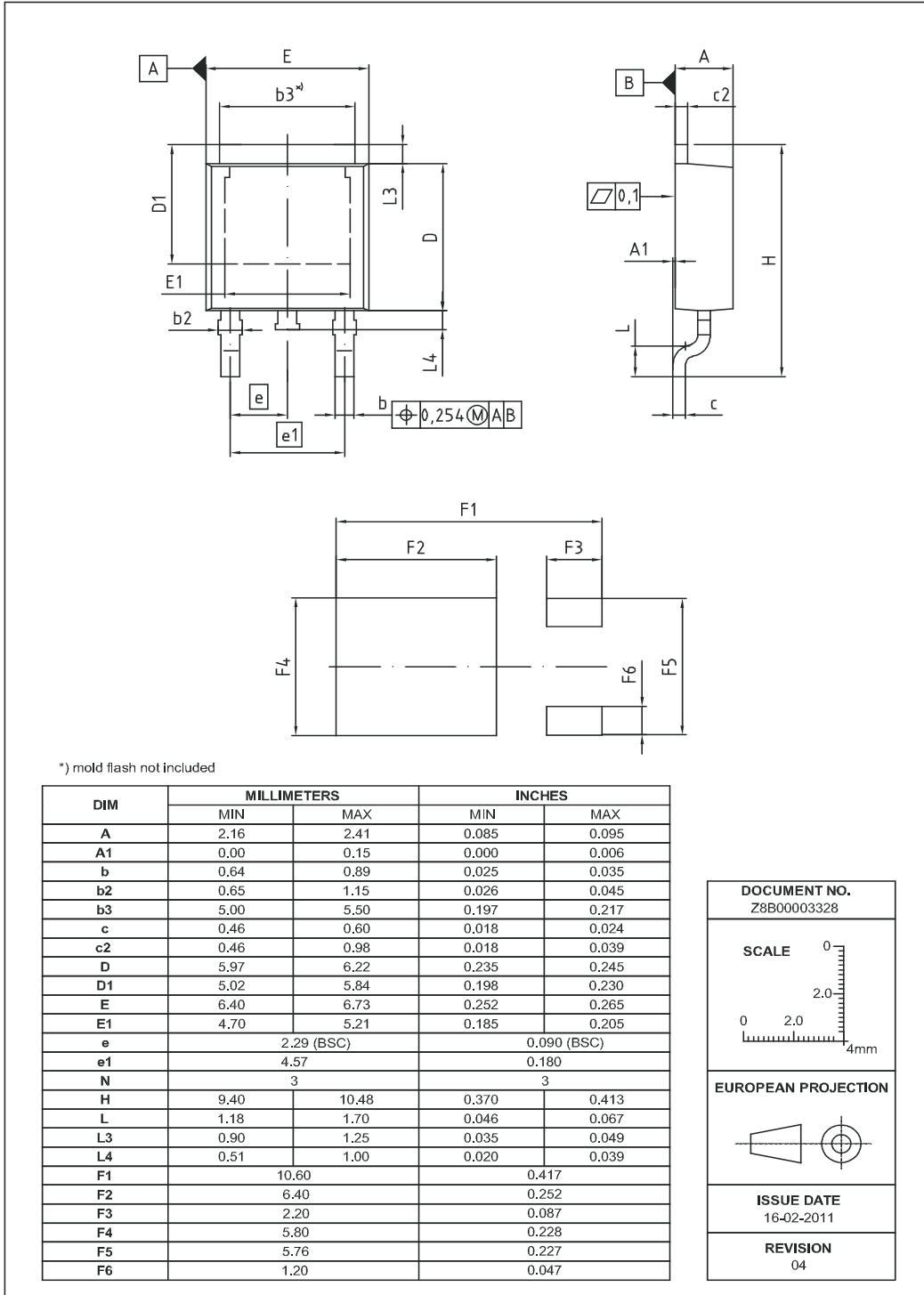

Figure 28. **Typical diode forward voltage as a function of junction temperature**

PG-TO252-3



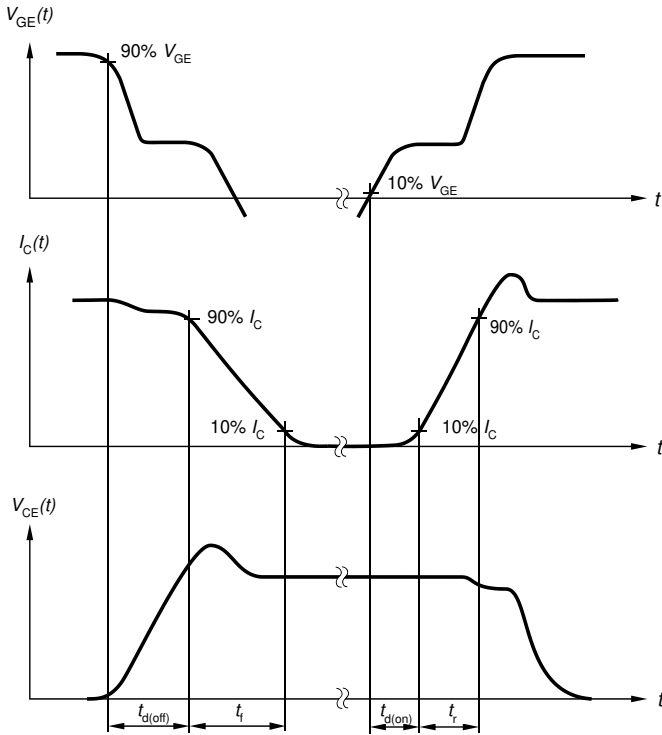

Figure A. Definition of switching times

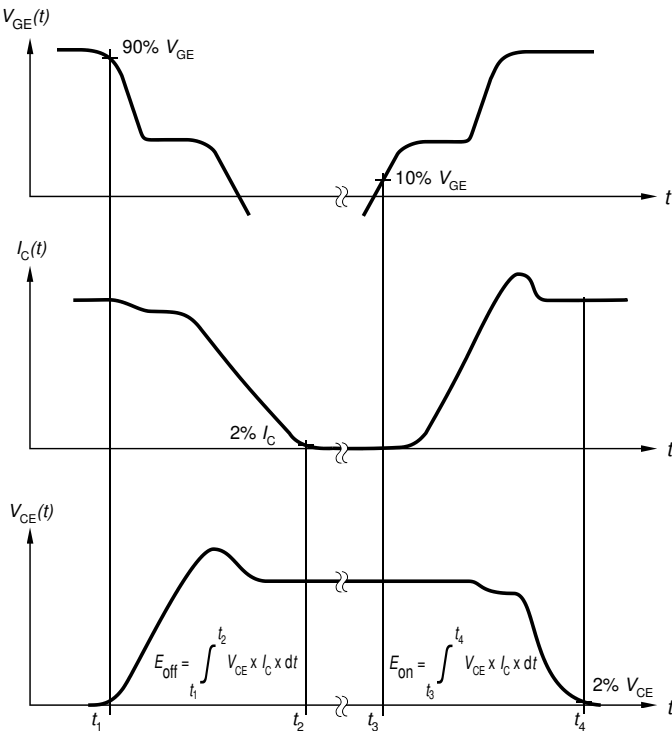

Figure B. Definition of switching losses

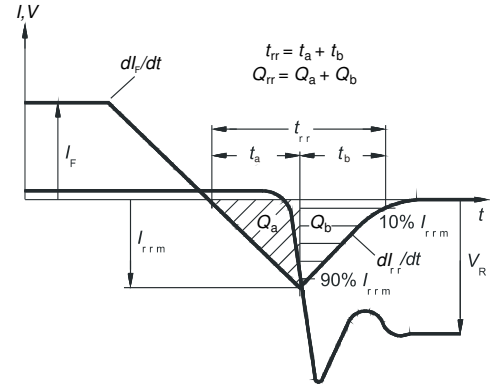

Figure C. Definition of diode switching characteristics

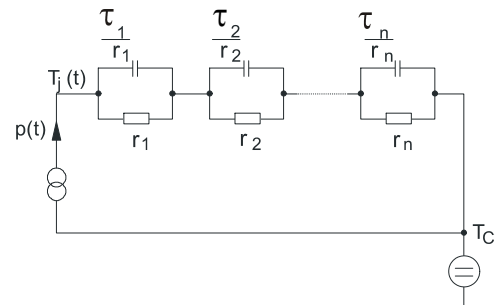

Figure D. Thermal equivalent circuit

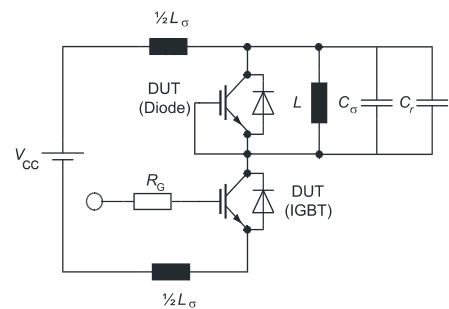

Figure E. Dynamic test circuit  
Parasitic inductance  $L_{\sigma}$ ,  
parasitic capacitor  $C_{\sigma}$ ,  
relief capacitor  $C_r$ ,  
(only for ZVT switching)

## Revision History

IKD10N60RFA

Revision: 2014-12-15, Rev. 2.1

## Previous Revision

Revision	Date	Subjects (major changes since last revision)
2.1	2014-12-15	Final data sheet

## We Listen to Your Comments

Any information within this document that you feel is wrong, unclear or missing at all?

Your feedback will help us to continuously improve the quality of this document.

Please send your proposal (including a reference to this document) to: [erratum@infineon.com](mailto:erratum@infineon.com)

## Published by

Infineon Technologies AG

81726 Munich, Germany

81726 München, Germany

© 2014 Infineon Technologies AG

All Rights Reserved.

## Legal Disclaimer

The information given in this document shall in no event be regarded as a guarantee of conditions or characteristics.

With respect to any examples or hints given herein, any typical values stated herein and/or any information regarding the application of the device, Infineon Technologies hereby disclaims any and all warranties and liabilities of any kind, including without limitation, warranties of non-infringement of intellectual property rights of any third party.

## Information

For further information on technology, delivery terms and conditions and prices, please contact the nearest Infineon Technologies Office ([www.infineon.com](http://www.infineon.com)).

## Warnings

Due to technical requirements, components may contain dangerous substances. For information on the types in question, please contact the nearest Infineon Technologies Office.

The Infineon Technologies component described in this Data Sheet may be used in life-support devices or systems and/or automotive, aviation and aerospace applications or systems only with the express written approval of Infineon Technologies, if a failure of such components can reasonably be expected to cause the failure of that life-support, automotive, aviation and aerospace device or system or to affect the safety or effectiveness of that device or system. Life support devices or systems are intended to be implanted in the human body or to support and/or maintain and sustain and/or protect human life. If they fail, it is reasonable to assume that the health of the user or other persons may be endangered.