

Sixth generation, high speed soft switching series

High speed soft switching TRENCHSTOP™ IGBT 6 in Trench and Fieldstop technology copacked with soft and fast recovery anti-parallel diode

Features:

1200V TRENCHSTOP™ IGBT6 technology offering:

- High efficiency in hard switching and resonant topologies
- Easy paralleling capability due to positive temperature coefficient in V_{CEsat}
- Low EMI
- Low Gate Charge Q_g
- Very soft, fast recovery full current anti-parallel diode
- Maximum junction temperature 175°C
- Pb-free lead plating; RoHS compliant
- Complete product spectrum and PSpice Models:
<http://www.infineon.com/igbt/>

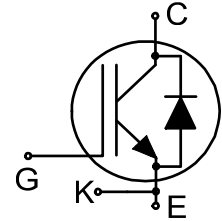

Applications:

- Industrial UPS
- Charger
- Energy storage
- Three-level Solar String Inverter
- Welding

Product Validation:

Qualified for industrial applications according to the relevant tests of JEDEC47/20/22



Key Performance and Package Parameters

Type	V_{CE}	I_C	$V_{CEsat}, T_{vj}=25^{\circ}C$	T_{vjmax}	Marking	Package
IKY75N120CS6	1200V	75A	1.85V	175°C	K75MCS6	PG-TO247-4-2

Sixth generation, high speed soft switching series

Table of Contents

Description	1
Table of Contents	2
Maximum Ratings	3
Thermal Resistance	3
Electrical Characteristics	4
Electrical Characteristics Diagrams	6
Package Drawing	13
Testing Conditions	14
Revision History	15
Disclaimer	16

Sixth generation, high speed soft switching series

Maximum Ratings

For optimum lifetime and reliability, Infineon recommends operating conditions that do not exceed 80% of the maximum ratings stated in this datasheet.

Parameter	Symbol	Value	Unit
Collector-emitter voltage, $T_{vj} \geq 25^{\circ}\text{C}$	V_{CE}	1200	V
DC collector current, limited by T_{vjmax} $T_c = 25^{\circ}\text{C}$ $T_c = 100^{\circ}\text{C}$	I_C	150.0 75.0	A
Pulsed collector current, t_p limited by T_{vjmax}	I_{Cpuls}	300.0	A
Turn off safe operating area $V_{CE} \leq 1200\text{V}$, $T_{vj} \leq 175^{\circ}\text{C}$	-	300.0	A
Diode forward current, limited by T_{vjmax} $T_c = 25^{\circ}\text{C}$ $T_c = 100^{\circ}\text{C}$	I_F	150.0 75.0	A
Diode pulsed current, t_p limited by T_{vjmax}	I_{Fpuls}	300.0	A
Gate-emitter voltage Transient Gate-emitter voltage ($t_p \leq 0.5\mu\text{s}$, $D < 0.001$)	V_{GE}	± 20 25	V
Power dissipation $T_c = 25^{\circ}\text{C}$ Power dissipation $T_c = 100^{\circ}\text{C}$	P_{tot}	880.0 440.0	W
Operating junction temperature	T_{vj}	-40...+175	$^{\circ}\text{C}$
Storage temperature	T_{stg}	-55...+150	$^{\circ}\text{C}$
Soldering temperature, wave soldering 1.6mm (0.063in.) from case for 10s		260	$^{\circ}\text{C}$

Thermal Resistance

Parameter	Symbol	Conditions	Value			Unit
			min.	typ.	max.	
R_{th} Characteristics						
IGBT thermal resistance, junction - case	$R_{th(j-c)}$		-	-	0.17	K/W
Diode thermal resistance, junction - case	$R_{th(j-c)}$		-	-	0.41	K/W
Thermal resistance junction - ambient	$R_{th(j-a)}$		-	-	40	K/W

Sixth generation, high speed soft switching series

Electrical Characteristic, at $T_{vj} = 25^{\circ}\text{C}$, unless otherwise specified

Parameter	Symbol	Conditions	Value			Unit
			min.	typ.	max.	
Static Characteristic						
Collector-emitter saturation voltage	V_{CEsat}	$V_{GE} = 15.0\text{V}$, $I_C = 75.0\text{A}$ $T_{vj} = 25^{\circ}\text{C}$ $T_{vj} = 125^{\circ}\text{C}$ $T_{vj} = 175^{\circ}\text{C}$	- - -	1.85 2.15 2.25	2.15 - -	V
Diode forward voltage	V_F	$V_{GE} = 0\text{V}$, $I_F = 75.0\text{A}$ $T_{vj} = 25^{\circ}\text{C}$ $T_{vj} = 175^{\circ}\text{C}$	- -	2.10 2.15	2.20 -	V
Gate-emitter threshold voltage	$V_{GE(th)}$	$I_C = 3.50\text{mA}$, $V_{CE} = V_{GE}$	5.1	5.7	6.3	V
Zero gate voltage collector current	I_{CES}	$V_{CE} = 1200\text{V}$, $V_{GE} = 0\text{V}$ $T_{vj} = 25^{\circ}\text{C}$ $T_{vj} = 175^{\circ}\text{C}$	- -	- 3500	1600 -	μA
Gate-emitter leakage current	I_{GES}	$V_{CE} = 0\text{V}$, $V_{GE} = 20\text{V}$	-	-	600	nA
Transconductance	g_{fs}	$V_{CE} = 20\text{V}$, $I_C = 75.0\text{A}$	-	60.0	-	S

Electrical Characteristic, at $T_{vj} = 25^{\circ}\text{C}$, unless otherwise specified

Parameter	Symbol	Conditions	Value			Unit
			min.	typ.	max.	
Dynamic Characteristic						
Input capacitance	C_{ies}	$V_{CE} = 25\text{V}$, $V_{GE} = 0\text{V}$, $f = 1\text{MHz}$	-	4900	-	pF
Output capacitance	C_{oes}		-	360	-	
Reverse transfer capacitance	C_{res}		-	225	-	
Gate charge	Q_G	$V_{CC} = 960\text{V}$, $I_C = 75.0\text{A}$, $V_{GE} = 15\text{V}$	-	530.0	-	nC
Internal emitter inductance measured 5mm (0.197 in.) from case	L_E		-	13.0	-	nH

Switching Characteristic, Inductive Load

Parameter	Symbol	Conditions	Value			Unit
			min.	typ.	max.	

IGBT Characteristic, at $T_{vj} = 25^{\circ}\text{C}$

Turn-on delay time	$t_{d(on)}$	$T_{vj} = 25^{\circ}\text{C}$, $V_{CC} = 600\text{V}$, $I_C = 75.0\text{A}$, $V_{GE} = 0.0/15.0\text{V}$, $R_{G(on)} = 4.0\Omega$, $R_{G(off)} = 4.0\Omega$, $L\sigma = 70\text{nH}$, $C\sigma = 67\text{pF}$ $L\sigma$, $C\sigma$ from Fig. E Energy losses include "tail" and diode reverse recovery.	-	32	-	ns
Rise time	t_r		-	32	-	ns
Turn-off delay time	$t_{d(off)}$		-	300	-	ns
Fall time	t_f		-	31	-	ns
Turn-on energy	E_{on}		-	2.20	-	mJ
Turn-off energy	E_{off}		-	2.95	-	mJ
Total switching energy	E_{ts}		-	5.15	-	mJ

Sixth generation, high speed soft switching series

Diode Characteristic, at $T_{vj} = 25^{\circ}\text{C}$

Diode reverse recovery time	t_{rr}	$T_{vj} = 25^{\circ}\text{C}$, $V_R = 600\text{V}$, $I_F = 75.0\text{A}$, $di_F/dt = 2700\text{A}/\mu\text{s}$, $L\sigma = 70\text{nH}$, $C\sigma = 67\text{pF}$	-	205	-	ns
Diode reverse recovery charge	Q_{rr}		-	4.70	-	μC
Diode peak reverse recovery current	I_{rrm}		-	76.0	-	A
Diode peak rate of fall of reverse recovery current during t_b	di_{rr}/dt		-	-1500	-	$\text{A}/\mu\text{s}$

Switching Characteristic, Inductive Load

Parameter	Symbol	Conditions	Value			Unit
			min.	typ.	max.	

IGBT Characteristic, at $T_{vj} = 175^{\circ}\text{C}$

Turn-on delay time	$t_{d(on)}$	$T_{vj} = 175^{\circ}\text{C}$, $V_{CC} = 600\text{V}$, $I_C = 75.0\text{A}$, $V_{GE} = 0.0/15.0\text{V}$, $R_{G(on)} = 4.0\Omega$, $R_{G(off)} = 4.0\Omega$, $L\sigma = 70\text{nH}$, $C\sigma = 67\text{pF}$ $L\sigma$, $C\sigma$ from Fig. E Energy losses include "tail" and diode reverse recovery.	-	33	-	ns
Rise time	t_r		-	33	-	ns
Turn-off delay time	$t_{d(off)}$		-	370	-	ns
Fall time	t_f		-	58	-	ns
Turn-on energy	E_{on}		-	3.30	-	mJ
Turn-off energy	E_{off}		-	5.30	-	mJ
Total switching energy	E_{ts}		-	8.60	-	mJ

Diode Characteristic, at $T_{vj} = 175^{\circ}\text{C}$

Diode reverse recovery time	t_{rr}	$T_{vj} = 175^{\circ}\text{C}$, $V_R = 600\text{V}$, $I_F = 75.0\text{A}$, $di_F/dt = 2700\text{A}/\mu\text{s}$, $L\sigma = 70\text{nH}$, $C\sigma = 67\text{pF}$	-	340	-	ns
Diode reverse recovery charge	Q_{rr}		-	10.60	-	μC
Diode peak reverse recovery current	I_{rrm}		-	105.0	-	A
Diode peak rate of fall of reverse recovery current during t_b	di_{rr}/dt		-	-1050	-	$\text{A}/\mu\text{s}$

Sixth generation, high speed soft switching series

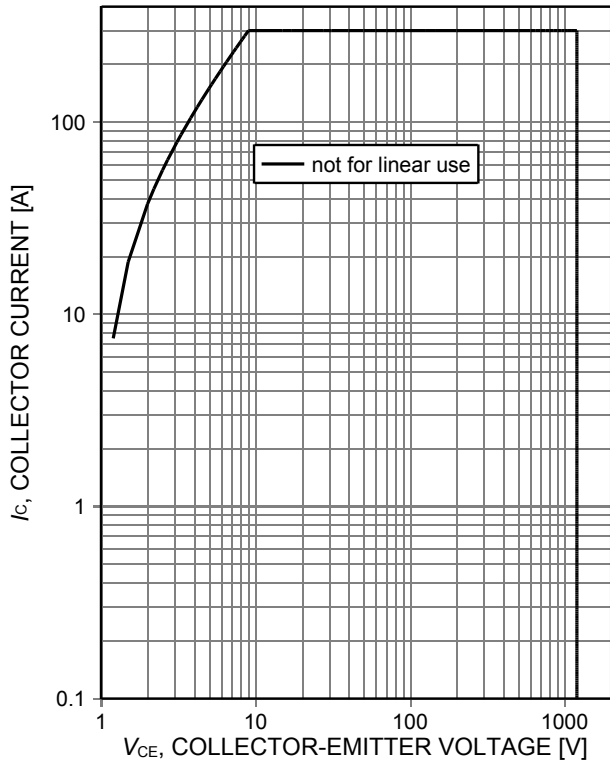

Figure 1. **Forward bias safe operating area**
 ($D=0$, $T_{vj} \leq 175^\circ\text{C}$; $V_{GE}=15\text{V}$, pulse width limited by T_{vjmax})

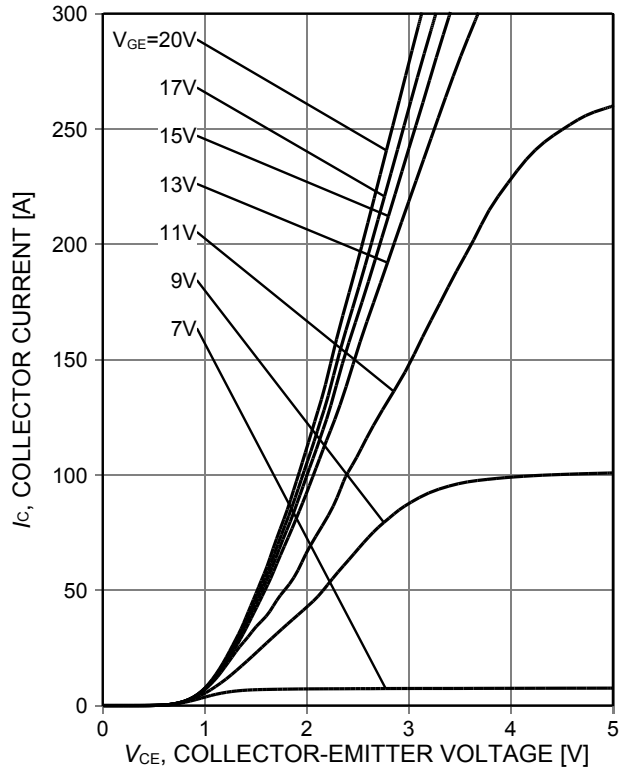

Figure 2. **Typical output characteristic**
 ($T_{vj}=25^\circ\text{C}$)

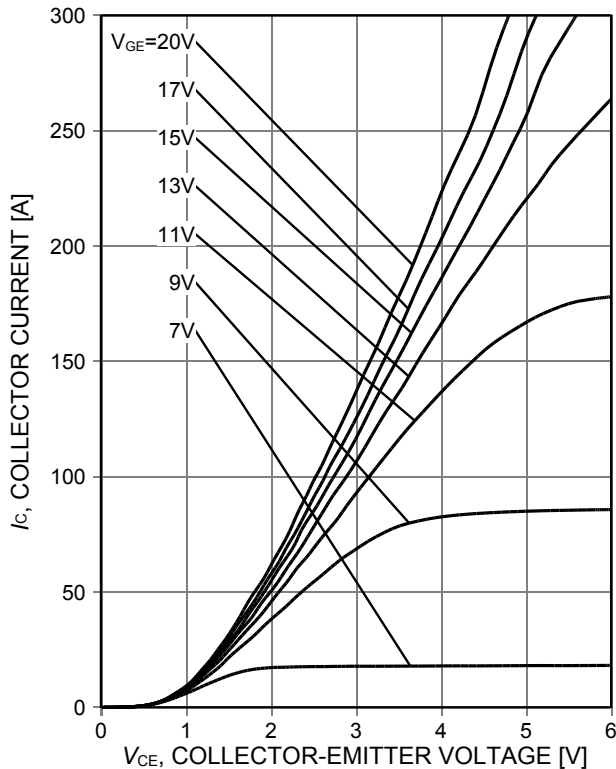

Figure 3. **Typical output characteristic**
 ($T_{vj}=175^\circ\text{C}$)

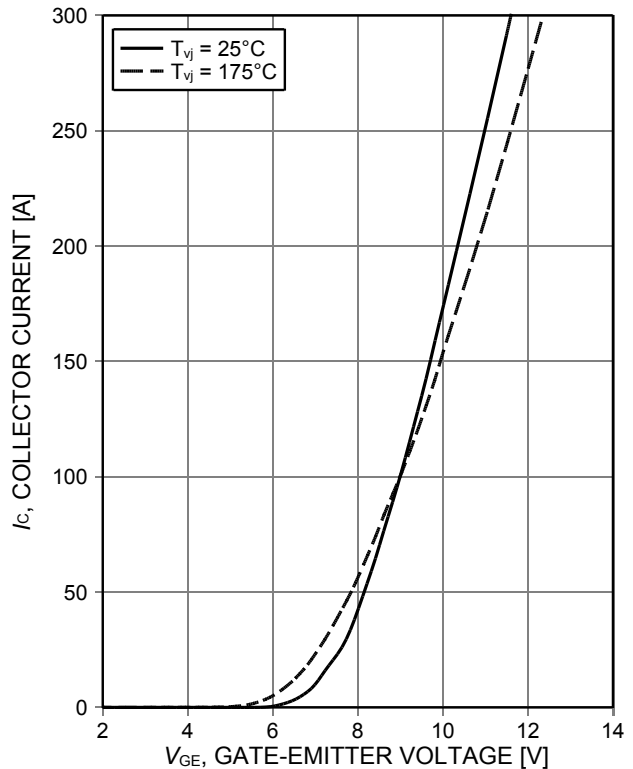

Figure 4. **Typical transfer characteristic**
 ($V_{CE}=20\text{V}$)

Sixth generation, high speed soft switching series

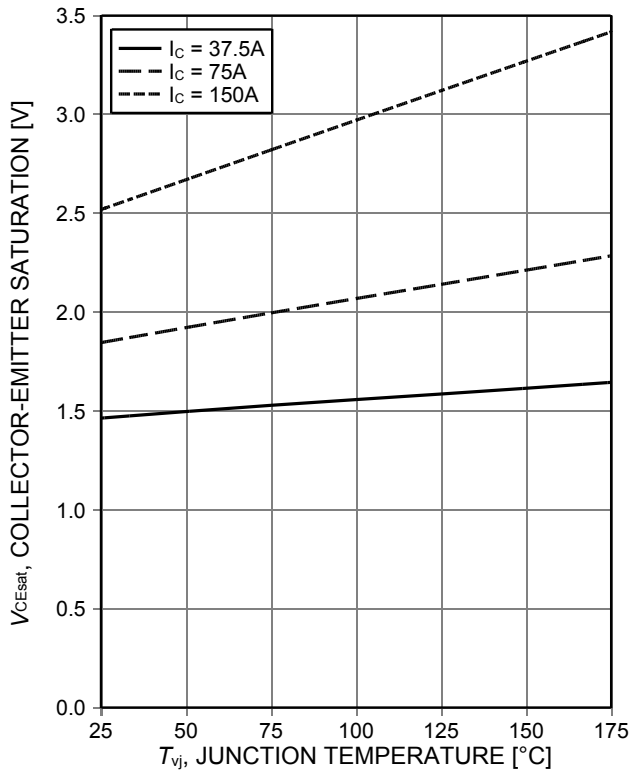

Figure 5. Typical collector-emitter saturation voltage as a function of junction temperature ($V_{GE}=15V$)

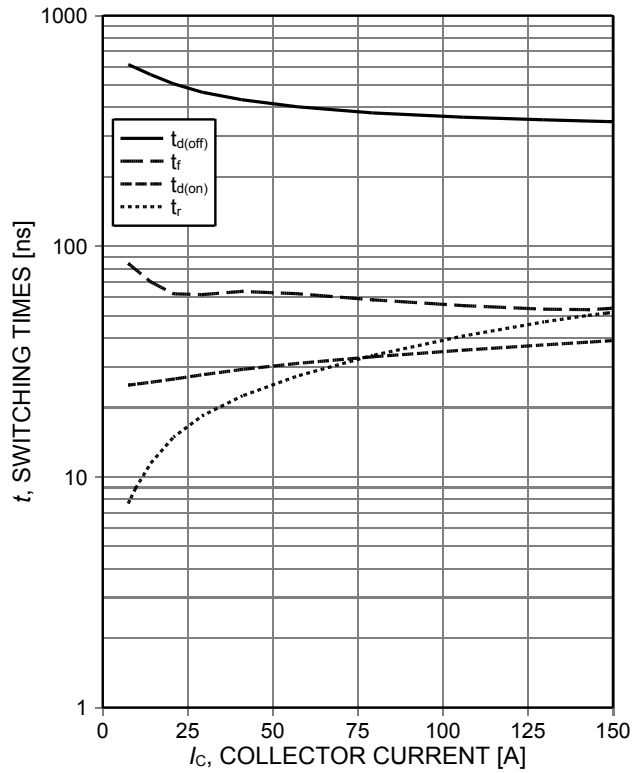

Figure 6. Typical switching times as a function of collector current (inductive load, $T_{vj}=175^{\circ}C$, $V_{CE}=600V$, $V_{GE}=0/15V$, $R_G=4\Omega$, Dynamic test circuit in Figure E)

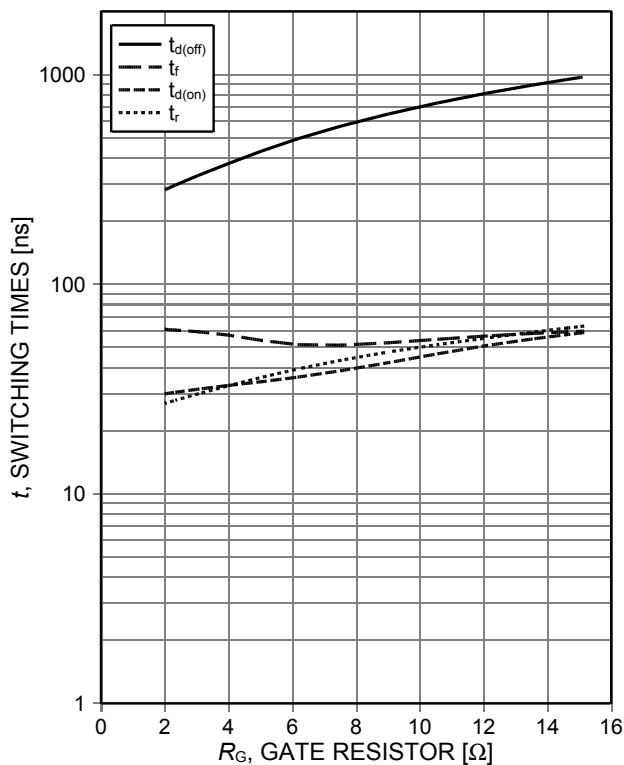

Figure 7. Typical switching times as a function of gate resistor (inductive load, $T_{vj}=175^{\circ}C$, $V_{CE}=600V$, $V_{GE}=0/15V$, $I_c=75A$, Dynamic test circuit in Figure E)

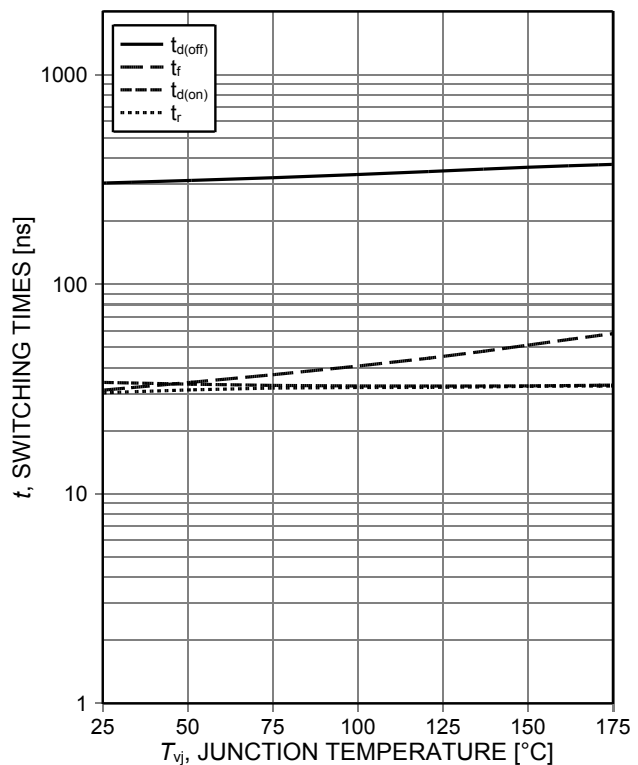

Figure 8. Typical switching times as a function of junction temperature (inductive load, $V_{CE}=600V$, $V_{GE}=0/15V$, $I_c=75A$, $R_G=4\Omega$, Dynamic test circuit in Figure E)

Sixth generation, high speed soft switching series

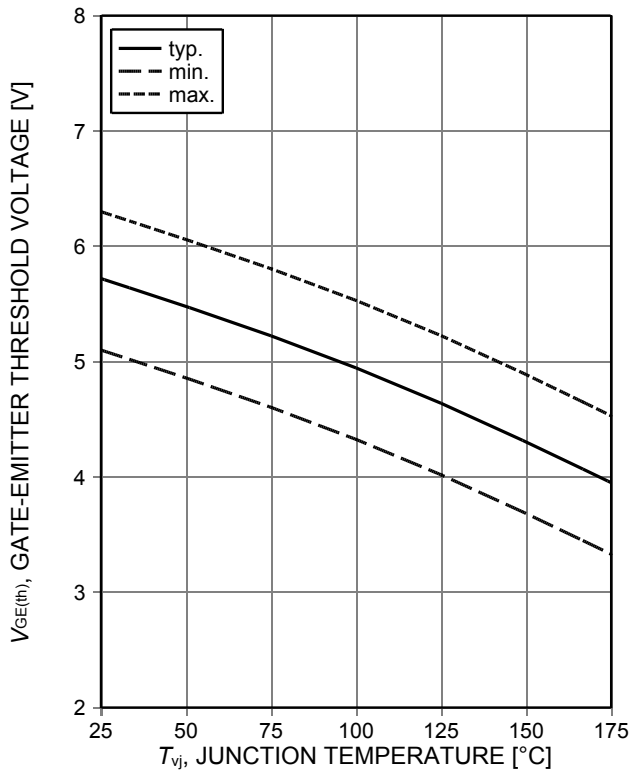

Figure 9. Gate-emitter threshold voltage as a function of junction temperature ($I_C=3.5\text{mA}$)

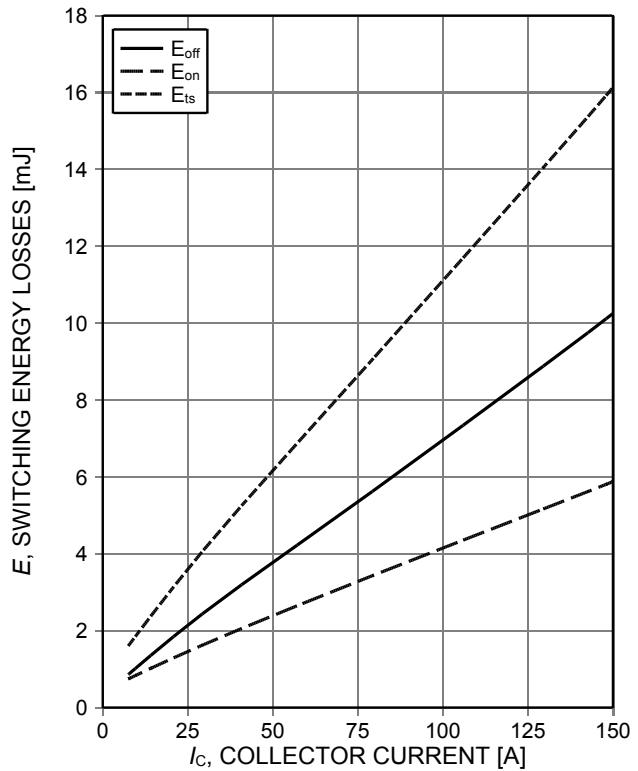

Figure 10. Typical switching energy losses as a function of collector current (inductive load, $T_{vj}=175^\circ\text{C}$, $V_{CE}=600\text{V}$, $V_{GE}=0/15\text{V}$, $R_G=4\Omega$, Dynamic test circuit in Figure E)

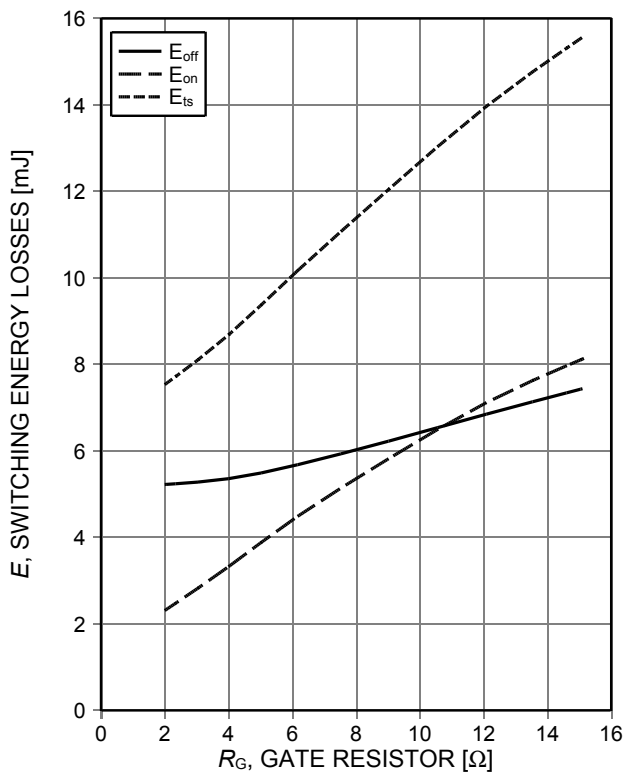

Figure 11. Typical switching energy losses as a function of gate resistor (inductive load, $T_{vj}=175^\circ\text{C}$, $V_{CE}=600\text{V}$, $V_{GE}=0/15\text{V}$, $I_C=75\text{A}$, Dynamic test circuit in Figure E)

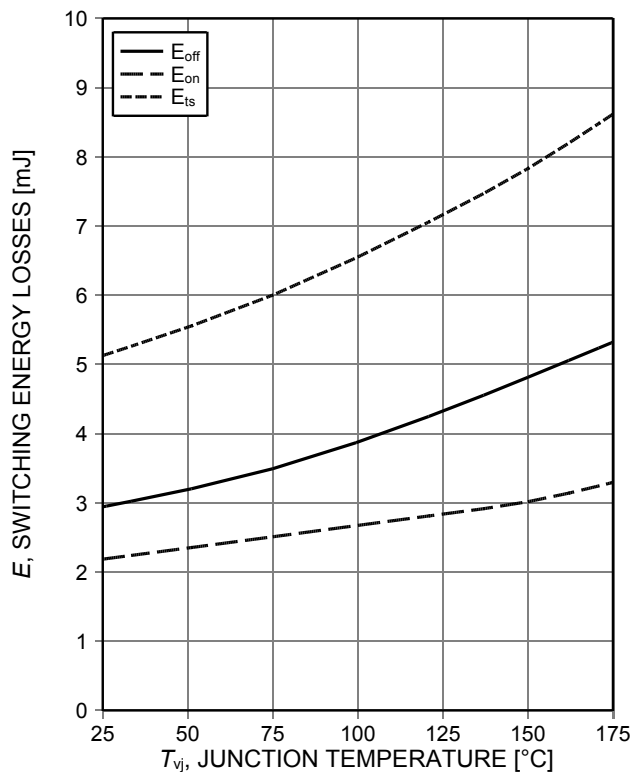

Figure 12. Typical switching energy losses as a function of junction temperature (inductive load, $V_{CE}=600\text{V}$, $V_{GE}=0/15\text{V}$, $I_C=75\text{A}$, $R_G=4\Omega$, Dynamic test circuit in Figure E)

Sixth generation, high speed soft switching series

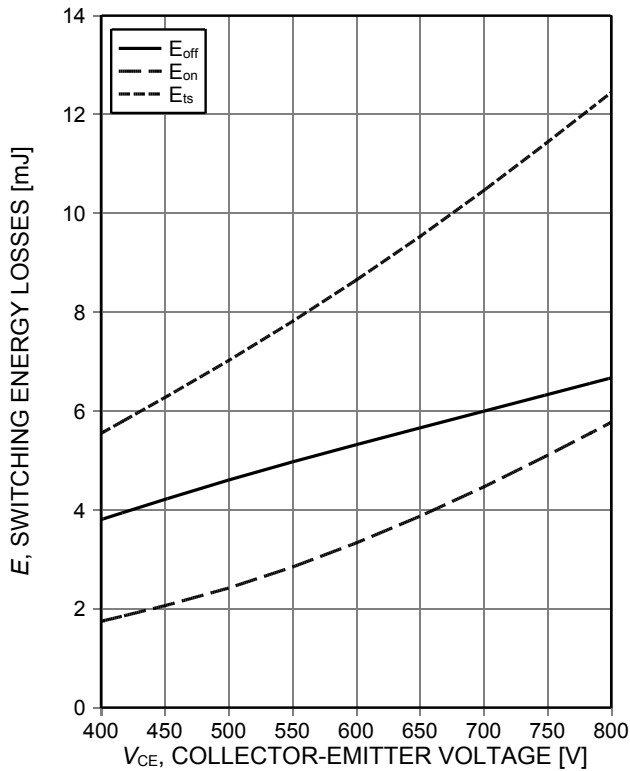

Figure 13. **Typical switching energy losses as a function of collector emitter voltage** (inductive load, $T_{vj}=175^{\circ}\text{C}$, $V_{GE}=0/15\text{V}$, $I_C=75\text{A}$, $R_G=4\Omega$, Dynamic test circuit in Figure E)

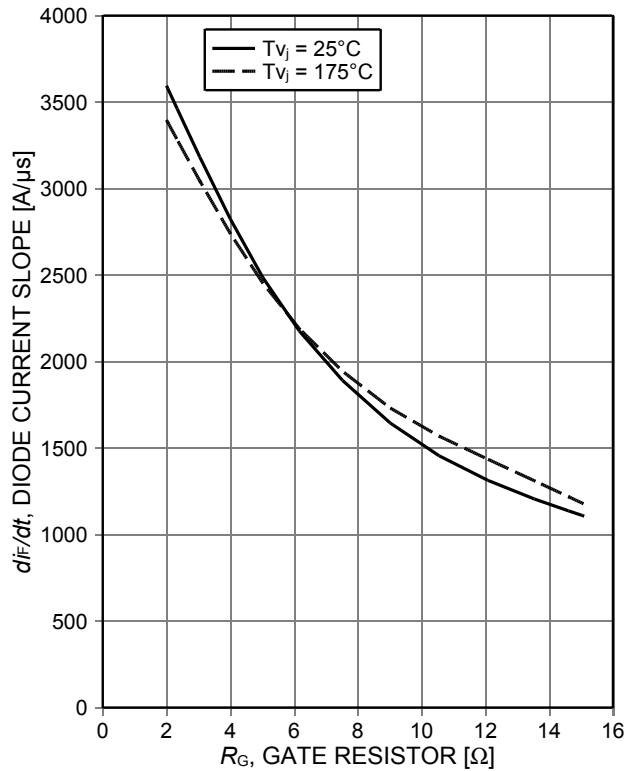

Figure 14. **Typical diode current slope as a function of gate resistor** (inductive load, $V_{CE}=600\text{V}$, $V_{GE}=0/15\text{V}$, $I_C=75\text{A}$, Dynamic test circuit in Figure E)

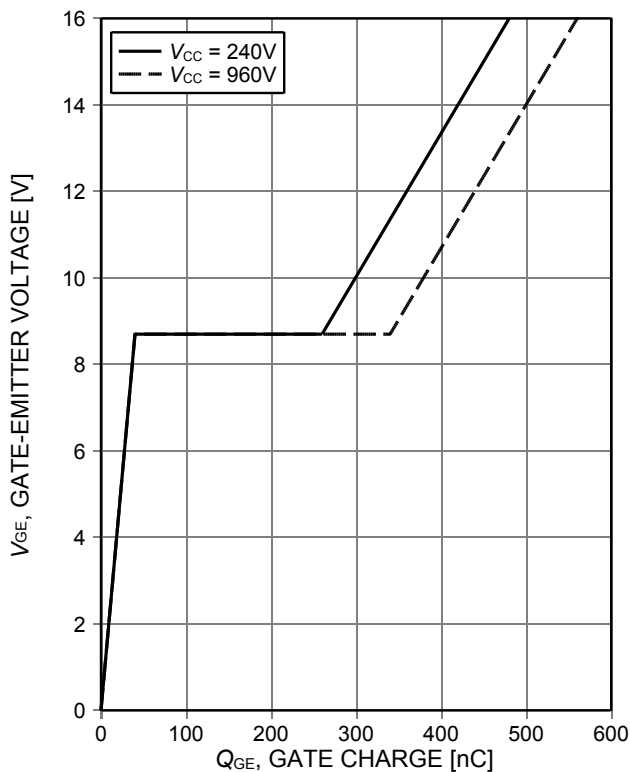

Figure 15. **Typical gate charge** ($I_C=75\text{A}$)

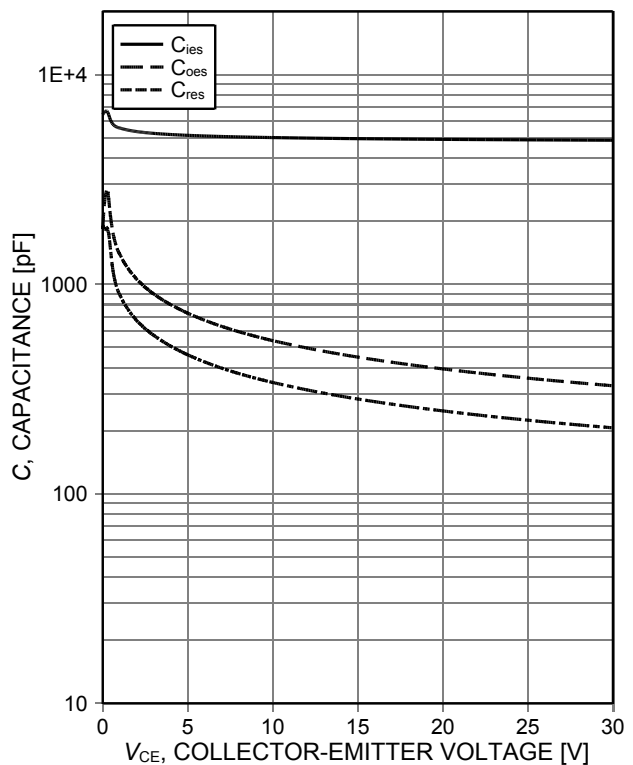

Figure 16. **Typical capacitance as a function of collector-emitter voltage** ($V_{GE}=0\text{V}$, $f=1\text{MHz}$)

Sixth generation, high speed soft switching series

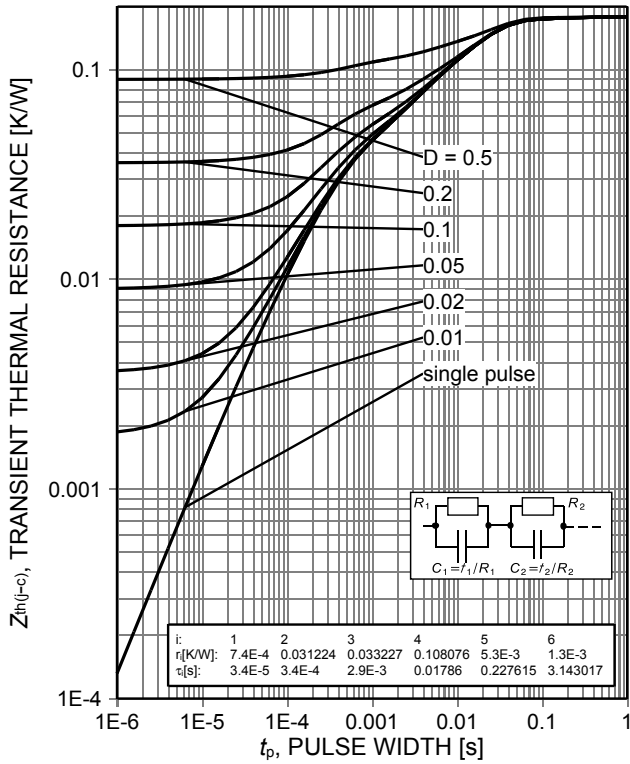

Figure 17. IGBT transient thermal resistance ($D=t_p/T$)

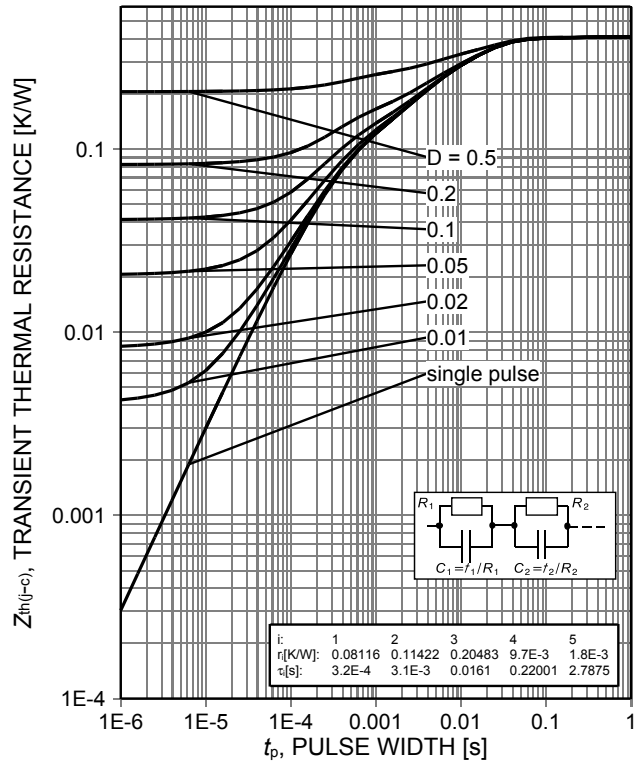

Figure 18. Diode transient thermal impedance as a function of pulse width ($D=t_p/T$)

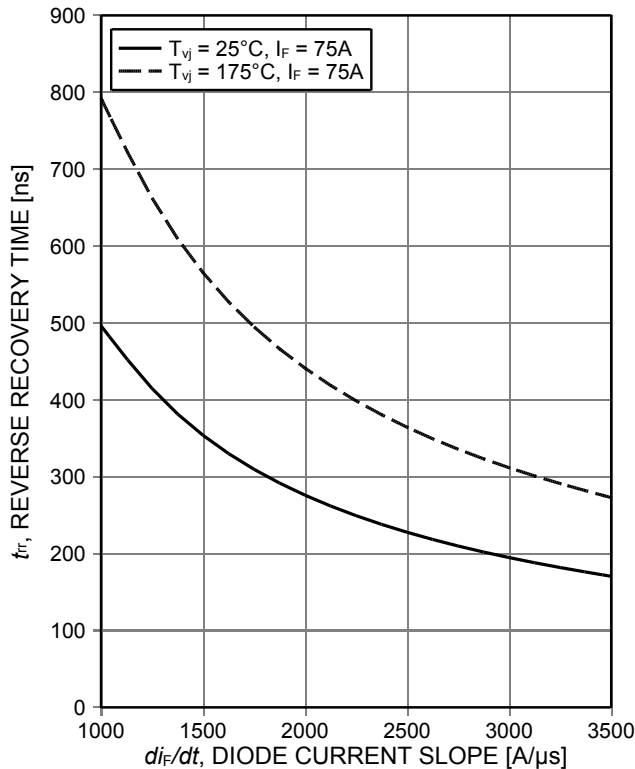

Figure 19. Typical reverse recovery time as a function of diode current slope ($V_R=600V$)

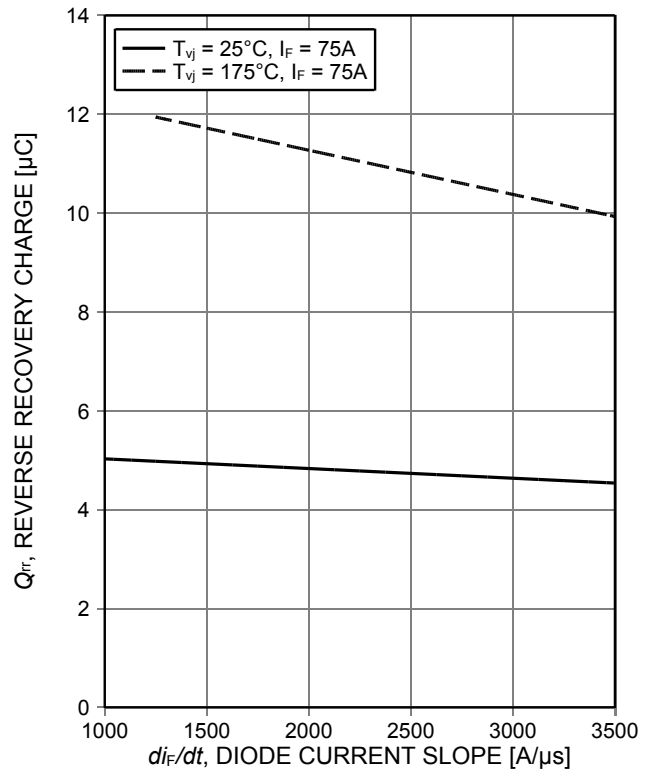

Figure 20. Typical reverse recovery charge as a function of diode current slope ($V_R=600V$)

Sixth generation, high speed soft switching series

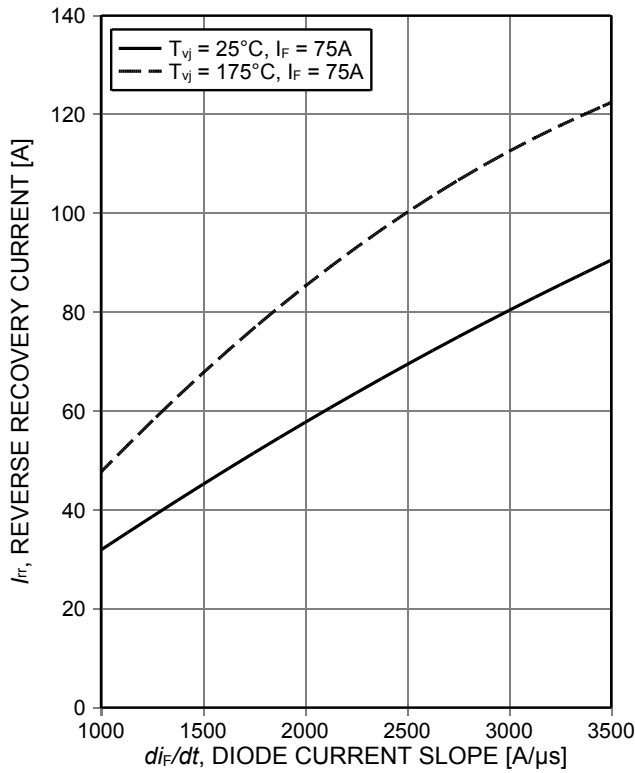

Figure 21. Typical reverse recovery current as a function of diode current slope ($V_R=600V$)

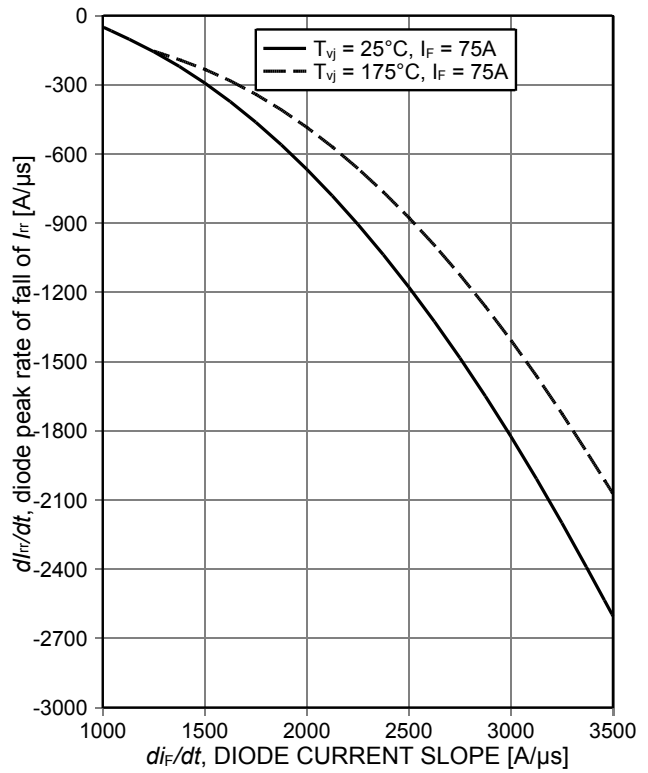

Figure 22. Typical diode peak rate of fall of reverse recovery current as a function of diode current slope ($V_R=600V$)

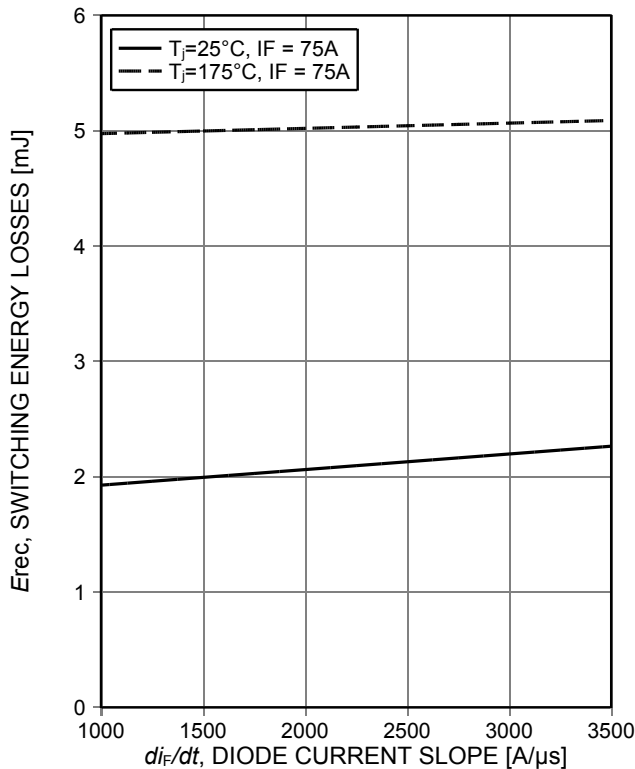

Figure 23. Typical reverse energy losses as a function of diode current slope ($V_R=600V$)

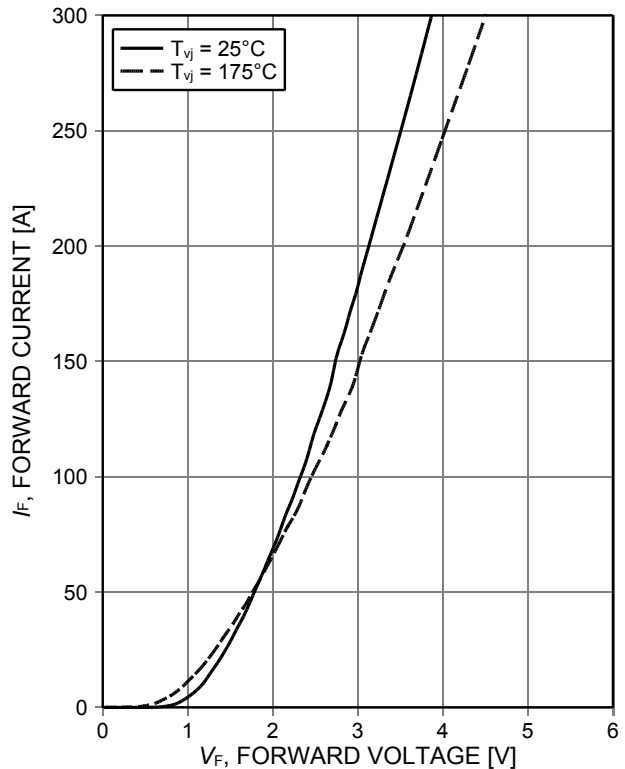

Figure 24. Typical diode forward current as a function of forward voltage

Sixth generation, high speed soft switching series

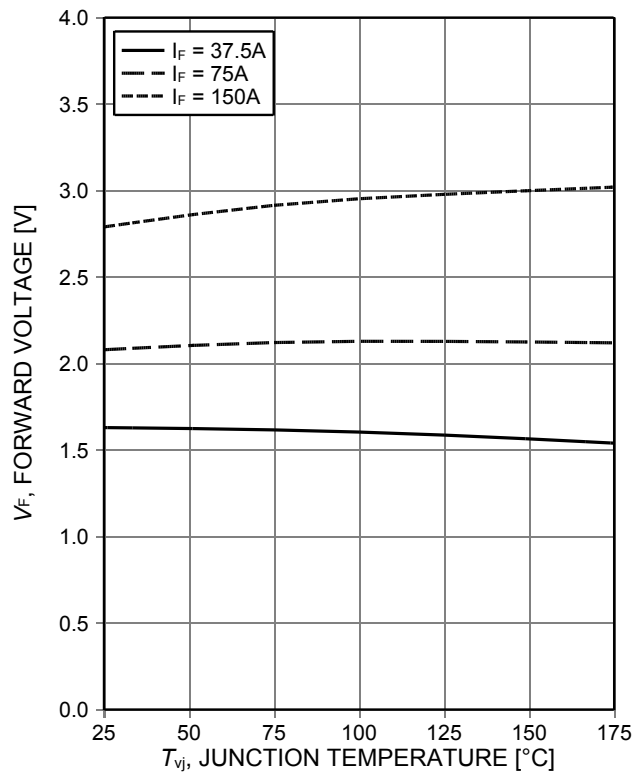
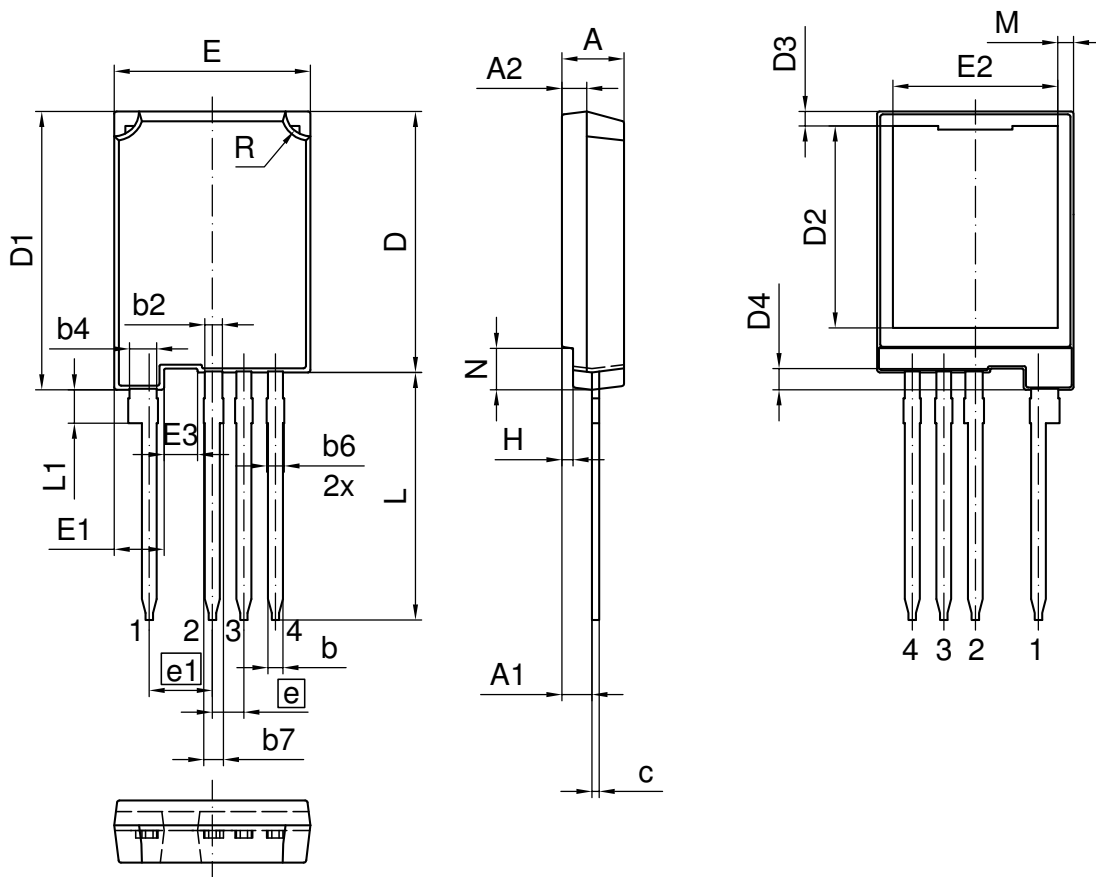

Figure 25. Typical diode forward voltage as a function of junction temperature

PG-TO247-4-2



NOTES:

PACKAGE SURFACE ROUTE BETWEEN PIN 1 & PIN 2 WILL BE 5.1mm MIN.

ALL b... AND c DIMENSIONS INCLUDING PLATING EXCEPT AREA OF CUTTING

DIMENSION	MILLIMETERS	
	MIN.	MAX.
A	4.9	5.1
A1	2.31	2.51
A2	1.9	2.1
b	1.16	1.29
b2	1.36	1.49
b4	2.16	2.29
b6	1.16	1.45
b7	1.16	1.65
c	0.59	0.66
D	20.9	21.1
D1	22.3	22.5
D2	15.95	16.55
D3	1	1.35
D4	1.6	1.8
E	15.7	15.9
E1	3.9	4.1
E2	13.1	13.5
E3	2.58	2.78
e	2.54	
e1	5.08	
H	0.8	1
L	19.8	20.1
L1	2.55	2.85
M	0.97	1.57
N	3.24	3.44
R	1.9	2.1

DOCUMENT NO. Z8B00182798
REVISION 01
SCALE 2:1
EUROPEAN PROJECTION
ISSUE DATE 23.09.2016

Testing Conditions

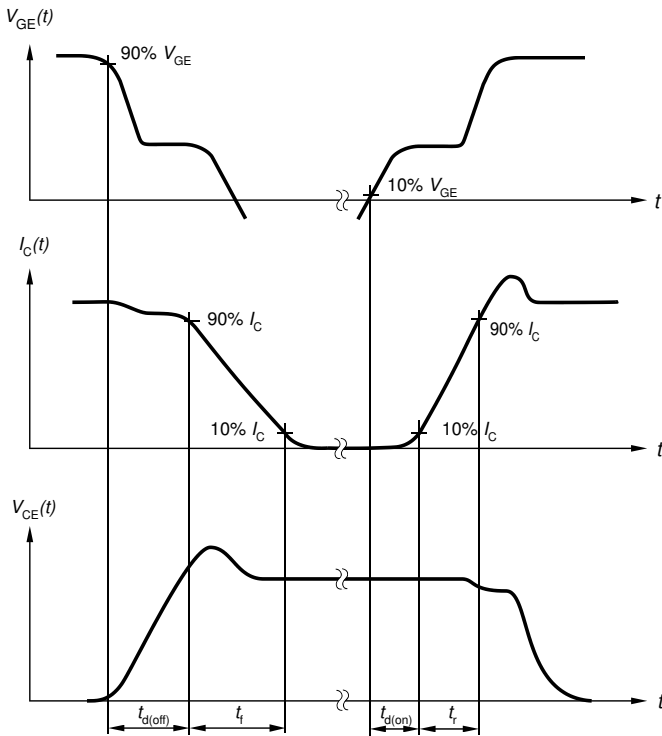

Figure A. Definition of switching times

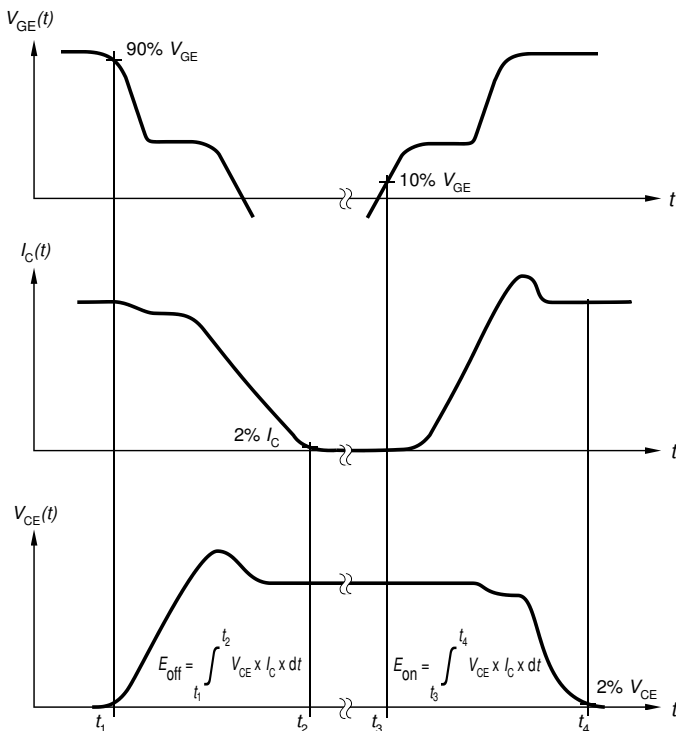

Figure B. Definition of switching losses

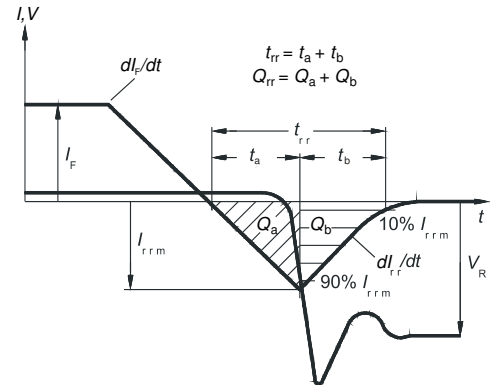

Figure C. Definition of diode switching characteristics

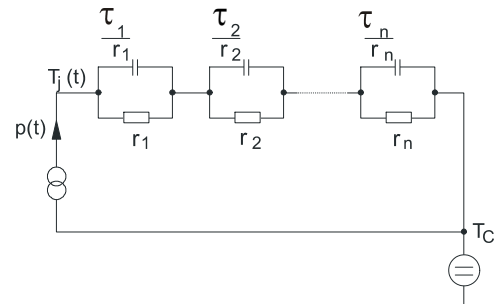

Figure D. Thermal equivalent circuit

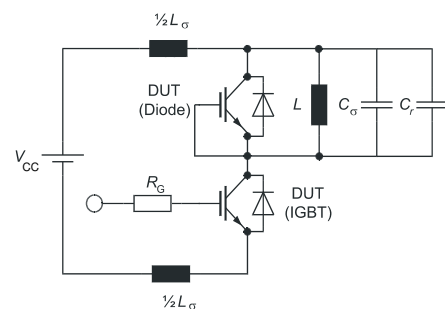

Figure E. Dynamic test circuit
Parasitic inductance L_σ ,
parasitic capacitor C_σ ,
relief capacitor C_r ,
(only for ZVT switching)

Sixth generation, high speed soft switching series

Revision History

IKY75N120CS6

Revision: 2018-08-07, Rev. 2.2

Previous Revision

Revision	Date	Subjects (major changes since last revision)
2.1	2018-05-07	Final data sheet
2.2	2018-08-07	Fig.5 and Fig.25 legend correction

Trademarks

All referenced product or service names and trademarks are the property of their respective owners.

Published by
Infineon Technologies AG
81726 München, Germany
© Infineon Technologies AG 2018.
All Rights Reserved.

Important Notice

The information given in this document shall in no event be regarded as a guarantee of conditions or characteristics ("Beschaffenheitsgarantie"). With respect to any examples, hints or any typical values stated herein and/or any information regarding the application of the product, Infineon Technologies hereby disclaims any and all warranties and liabilities of any kind, including without limitation warranties of non-infringement of intellectual property rights of any third party.

In addition, any information given in this document is subject to customer's compliance with its obligations stated in this document and any applicable legal requirements, norms and standards concerning customer's products and any use of the product of Infineon Technologies in customer's applications.

The data contained in this document is exclusively intended for technically trained staff. It is the responsibility of customer's technical departments to evaluate the suitability of the product for the intended application and the completeness of the product information given in this document with respect to such application.

For further information on the product, technology, delivery terms and conditions and prices please contact your nearest Infineon Technologies office (www.infineon.com).

Please note that this product is not qualified according to the AEC Q100 or AEC Q101 documents of the Automotive Electronics Council.

Warnings

Due to technical requirements products may contain dangerous substances. For information on the types in question please contact your nearest Infineon Technologies office.

Except as otherwise explicitly approved by Infineon Technologies in a written document signed by authorized representatives of Infineon Technologies, Infineon Technologies' products may not be used in any applications where a failure of the product or any consequences of the use thereof can reasonably be expected to result in personal injury.