

## Fast IGBT in NPT-technology

- 75% lower  $E_{off}$  compared to previous generation combined with low conduction losses
- Short circuit withstand time – 10  $\mu$ s
- Designed for:
  - Motor controls
  - Inverter
- NPT-Technology for 600V applications offers:
  - very tight parameter distribution
  - high ruggedness, temperature stable behaviour
  - parallel switching capability

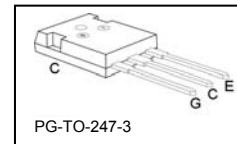
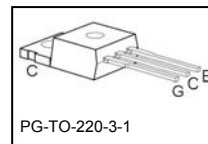
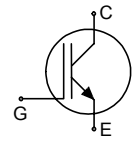

- Qualified according to JEDEC<sup>1</sup> for target applications
- Pb-free lead plating; RoHS compliant
- Complete product spectrum and PSpice Models : <http://www.infineon.com/igbt/>

Type	$V_{CE}$	$I_C$	$V_{CE(sat)}$	$T_j$	Marking	Package
SGP20N60	600V	20A	2.4V	150°C	G20N60	PG-TO-220-3-1
SGW20N60	600V	20A	2.4V	150°C	G20N60	PG-TO-247-3

### Maximum Ratings

Parameter	Symbol	Value	Unit
Collector-emitter voltage	$V_{CE}$	600	V
DC collector current	$I_C$	40	A
$T_C = 25^\circ\text{C}$		20	
$T_C = 100^\circ\text{C}$			
Pulsed collector current, $t_p$ limited by $T_{jmax}$	$I_{Cpuls}$	80	
Turn off safe operating area	-	80	
$V_{CE} \leq 600\text{V}$ , $T_j \leq 150^\circ\text{C}$			
Gate-emitter voltage	$V_{GE}$	$\pm 20$	V
Avalanche energy, single pulse	$E_{AS}$	115	mJ
$I_C = 20\text{ A}$ , $V_{CC} = 50\text{ V}$ , $R_{GE} = 25\ \Omega$ , start at $T_j = 25^\circ\text{C}$			
Short circuit withstand time <sup>2</sup>	$t_{SC}$	10	$\mu$ s
$V_{GE} = 15\text{V}$ , $V_{CC} \leq 600\text{V}$ , $T_j \leq 150^\circ\text{C}$			
Power dissipation	$P_{tot}$	179	W
$T_C = 25^\circ\text{C}$			
Operating junction and storage temperature	$T_j$ , $T_{stg}$	-55...+150	$^\circ\text{C}$
Soldering temperature, wavesoldering, 1.6mm (0.063 in.) from case for 10s	$T_s$	260	

<sup>1</sup> J-STD-020 and JESD-022

<sup>2</sup> Allowed number of short circuits: <1000; time between short circuits: >1s.

### Thermal Resistance

Parameter	Symbol	Conditions	Max. Value	Unit
<b>Characteristic</b>				
IGBT thermal resistance, junction – case	$R_{thJC}$		0.7	K/W
Thermal resistance, junction – ambient	$R_{thJA}$	PG-TO-220-3-1 PG-TO-247-3-21	62 40	

### Electrical Characteristic, at $T_j = 25^\circ\text{C}$ , unless otherwise specified

Parameter	Symbol	Conditions	Value			Unit
			min.	Typ.	max.	
<b>Static Characteristic</b>						
Collector-emitter breakdown voltage	$V_{(BR)CES}$	$V_{GE}=0V, I_C=500\mu A$	600	-	-	V
Collector-emitter saturation voltage	$V_{CE(sat)}$	$V_{GE} = 15V, I_C=20A$ $T_j=25^\circ\text{C}$ $T_j=150^\circ\text{C}$	1.7 -	2 2.4	2.4 2.9	
Gate-emitter threshold voltage	$V_{GE(th)}$	$I_C=700\mu A, V_{CE}=V_{GE}$	3	4	5	
Zero gate voltage collector current	$I_{CES}$	$V_{CE}=600V, V_{GE}=0V$ $T_j=25^\circ\text{C}$ $T_j=150^\circ\text{C}$	- -	- -	40 2500	$\mu A$
Gate-emitter leakage current	$I_{GES}$	$V_{CE}=0V, V_{GE}=20V$	-	-	100	nA
Transconductance	$g_{fs}$	$V_{CE}=20V, I_C=20A$	-	14	-	S
<b>Dynamic Characteristic</b>						
Input capacitance	$C_{iss}$	$V_{CE}=25V,$	-	1100	1320	pF
Output capacitance	$C_{oss}$	$V_{GE}=0V,$	-	107	128	
Reverse transfer capacitance	$C_{rss}$	$f=1\text{MHz}$	-	63	76	
Gate charge	$Q_{Gate}$	$V_{CC}=480V, I_C=20A$ $V_{GE}=15V$	-	100	130	nC
Internal emitter inductance measured 5mm (0.197 in.) from case	$L_E$	PG-TO-220-3-1 PG-TO-247-3-21	- -	7 13	- -	nH
Short circuit collector current <sup>2)</sup>	$I_{C(SC)}$	$V_{GE}=15V, t_{SC}\leq 10\mu s$ $V_{CC}\leq 600V,$ $T_j\leq 150^\circ\text{C}$	-	200	-	A

<sup>2)</sup> Allowed number of short circuits: <1000; time between short circuits: >1s.

### Switching Characteristic, Inductive Load, at $T_j=25^\circ\text{C}$

Parameter	Symbol	Conditions	Value			Unit
			min.	typ.	max.	
<b>IGBT Characteristic</b>						
Turn-on delay time	$t_{d(\text{on})}$	$T_j=25^\circ\text{C}$ , $V_{\text{CC}}=400\text{V}$ , $I_{\text{C}}=20\text{A}$ , $V_{\text{GE}}=0/15\text{V}$ , $R_{\text{G}}=16\Omega$ , $L_{\sigma}^{(1)}=180\text{nH}$ , $C_{\sigma}^{(1)}=900\text{pF}$ Energy losses include "tail" and diode reverse recovery.	-	36	46	ns
Rise time	$t_{\text{r}}$		-	30	36	
Turn-off delay time	$t_{d(\text{off})}$		-	225	270	
Fall time	$t_{\text{f}}$		-	54	65	
Turn-on energy	$E_{\text{on}}$		-	0.44	0.53	mJ
Turn-off energy	$E_{\text{off}}$		-	0.33	0.43	
Total switching energy	$E_{\text{ts}}$		-	0.77	0.96	

### Switching Characteristic, Inductive Load, at $T_j=150^\circ\text{C}$

Parameter	Symbol	Conditions	Value			Unit
			min.	typ.	max.	
<b>IGBT Characteristic</b>						
Turn-on delay time	$t_{d(\text{on})}$	$T_j=150^\circ\text{C}$ $V_{\text{CC}}=400\text{V}$ , $I_{\text{C}}=20\text{A}$ , $V_{\text{GE}}=0/15\text{V}$ , $R_{\text{G}}=16\Omega$ , $L_{\sigma}^{(1)}=180\text{nH}$ , $C_{\sigma}^{(1)}=900\text{pF}$ Energy losses include "tail" and diode reverse recovery.	-	36	46	ns
Rise time	$t_{\text{r}}$		-	30	36	
Turn-off delay time	$t_{d(\text{off})}$		-	250	300	
Fall time	$t_{\text{f}}$		-	63	76	
Turn-on energy	$E_{\text{on}}$		-	0.67	0.81	mJ
Turn-off energy	$E_{\text{off}}$		-	0.49	0.64	
Total switching energy	$E_{\text{ts}}$		-	1.12	1.45	

<sup>1)</sup> Leakage inductance  $L_{\sigma}$  and Stray capacity  $C_{\sigma}$  due to dynamic test circuit in Figure E.

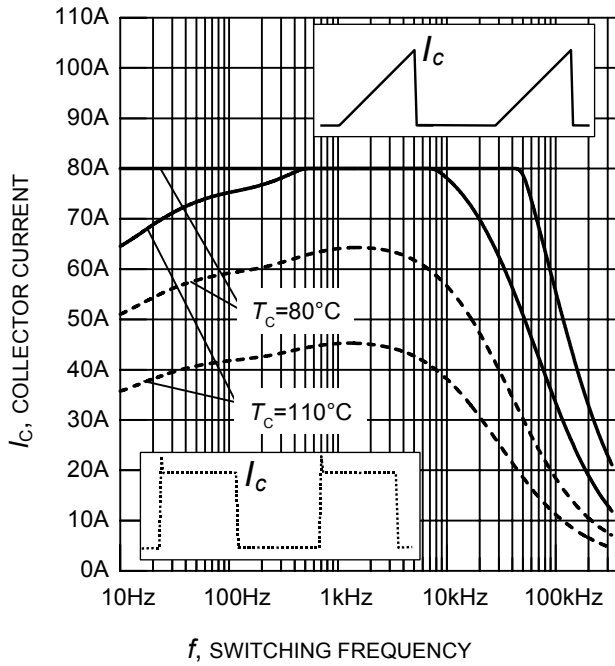

**Figure 1. Collector current as a function of switching frequency**  
 ( $T_j \leq 150^\circ\text{C}$ ,  $D = 0.5$ ,  $V_{CE} = 400\text{V}$ ,  
 $V_{GE} = 0/+15\text{V}$ ,  $R_G = 16\Omega$ )

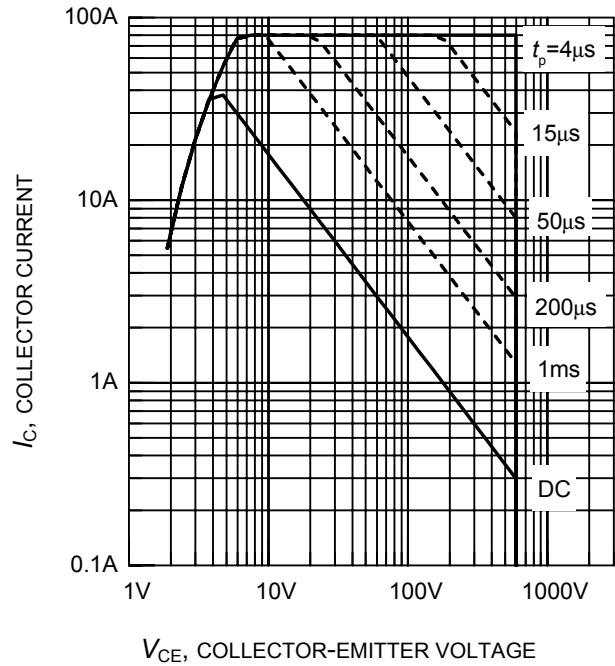

**Figure 2. Safe operating area**  
 ( $D = 0$ ,  $T_C = 25^\circ\text{C}$ ,  $T_j \leq 150^\circ\text{C}$ )

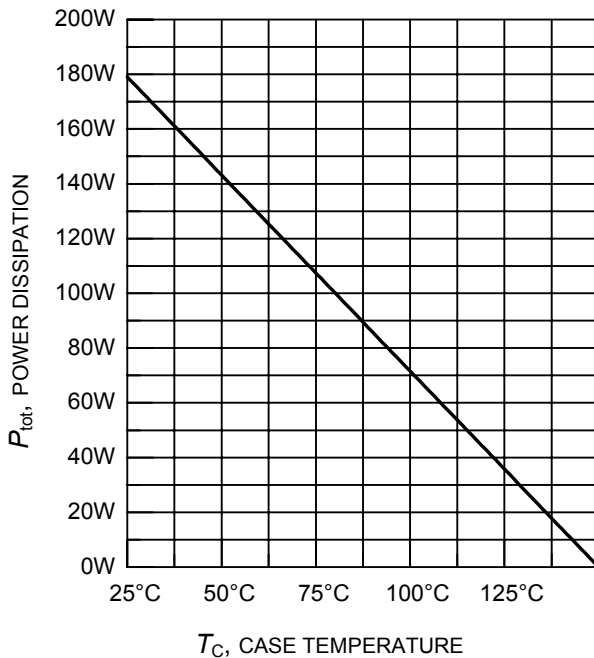

**Figure 3. Power dissipation as a function of case temperature**  
 ( $T_j \leq 150^\circ\text{C}$ )

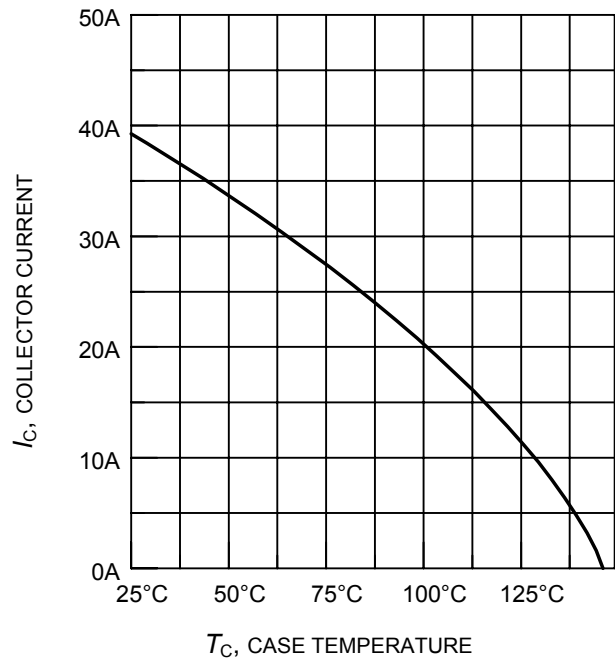

**Figure 4. Collector current as a function of case temperature**  
 ( $V_{GE} \leq 15\text{V}$ ,  $T_j \leq 150^\circ\text{C}$ )

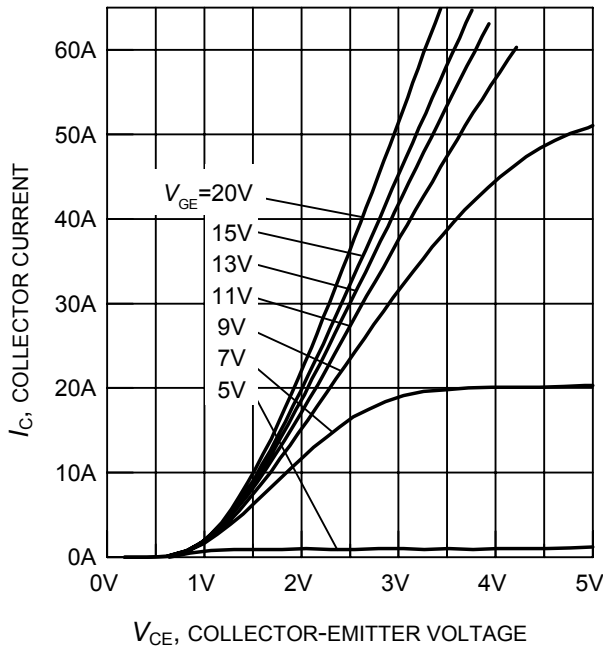

**Figure 5. Typical output characteristics**  
( $T_j = 25^\circ\text{C}$ )

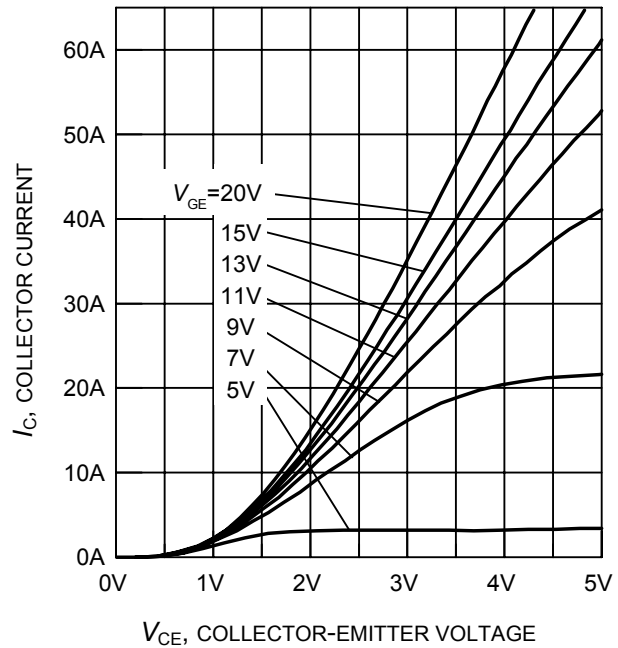

**Figure 6. Typical output characteristics**  
( $T_j = 150^\circ\text{C}$ )

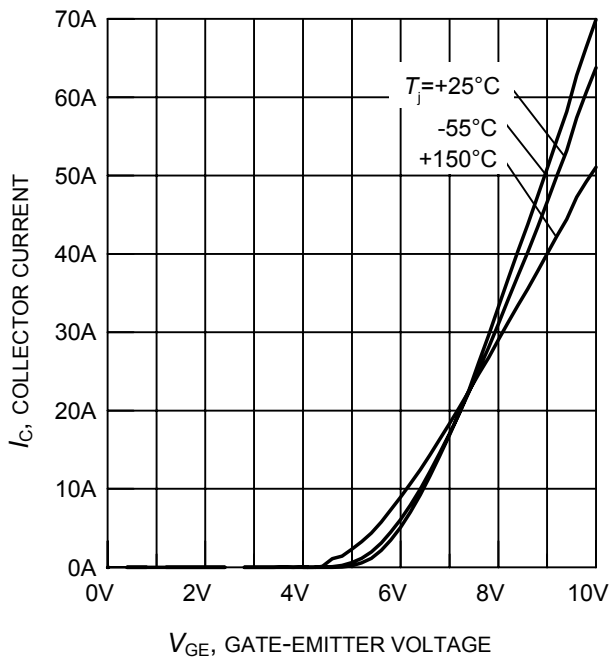

**Figure 7. Typical transfer characteristics**  
( $V_{CE} = 10\text{V}$ )

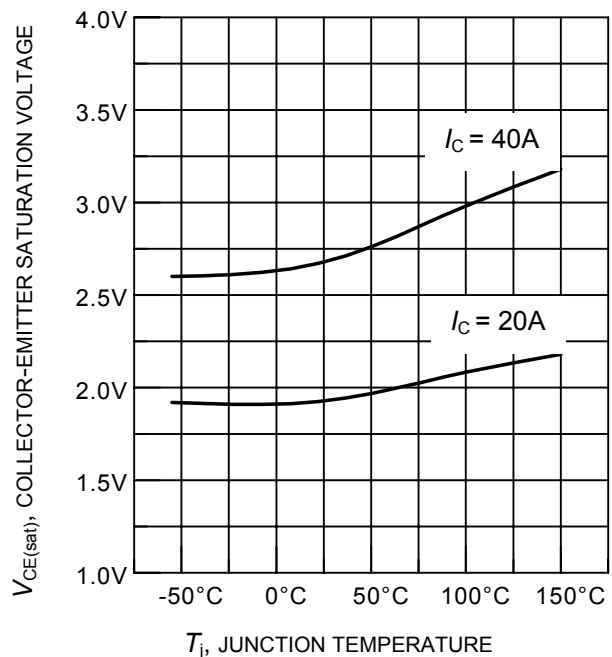

**Figure 8. Typical collector-emitter saturation voltage as a function of junction temperature**  
( $V_{GE} = 15\text{V}$ )

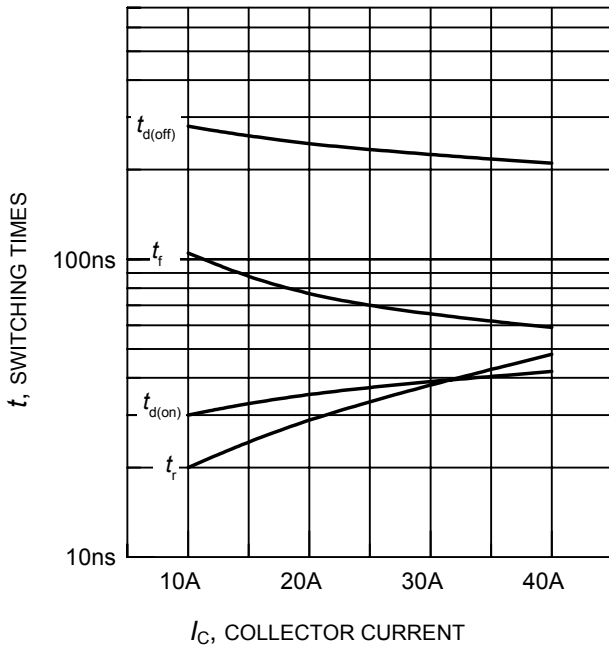

**Figure 9. Typical switching times as a function of collector current**  
(inductive load,  $T_j = 150^\circ\text{C}$ ,  $V_{CE} = 400\text{V}$ ,  $V_{GE} = 0/+15\text{V}$ ,  $R_G = 16\Omega$ ,  
Dynamic test circuit in Figure E)

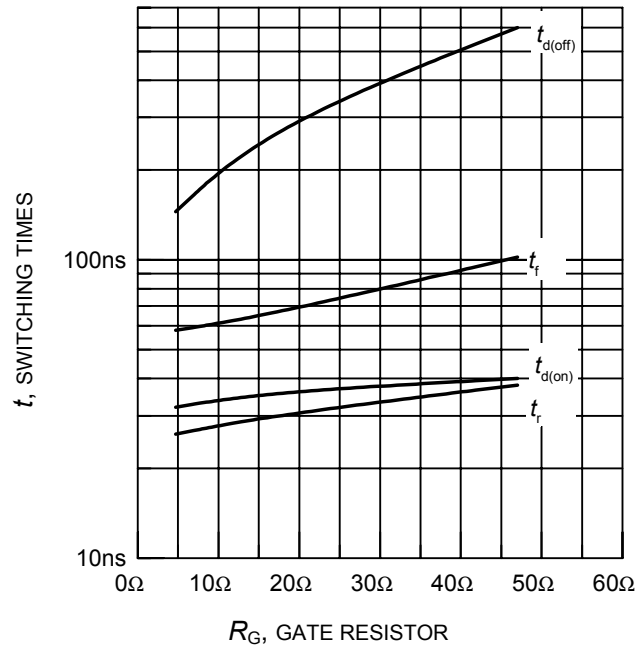

**Figure 10. Typical switching times as a function of gate resistor**  
(inductive load,  $T_j = 150^\circ\text{C}$ ,  $V_{CE} = 400\text{V}$ ,  $V_{GE} = 0/+15\text{V}$ ,  $I_C = 20\text{A}$ ,  
Dynamic test circuit in Figure E)

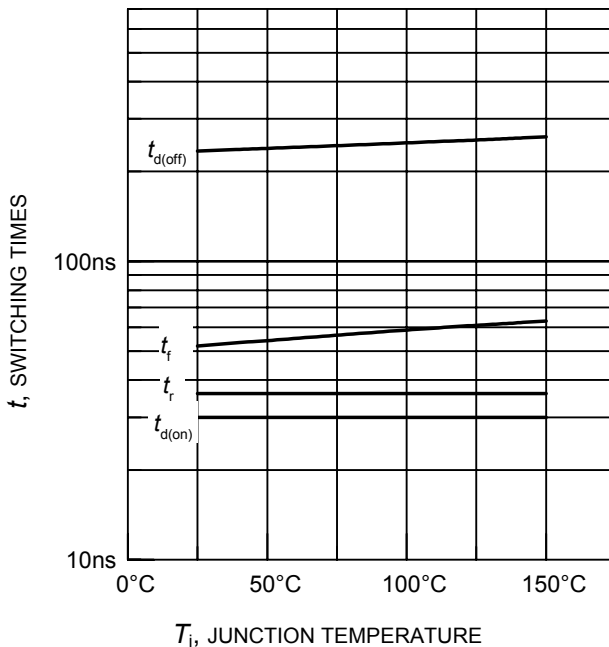

**Figure 11. Typical switching times as a function of junction temperature**  
(inductive load,  $V_{CE} = 400\text{V}$ ,  $V_{GE} = 0/+15\text{V}$ ,  $I_C = 20\text{A}$ ,  $R_G = 16\Omega$ ,  
Dynamic test circuit in Figure E)

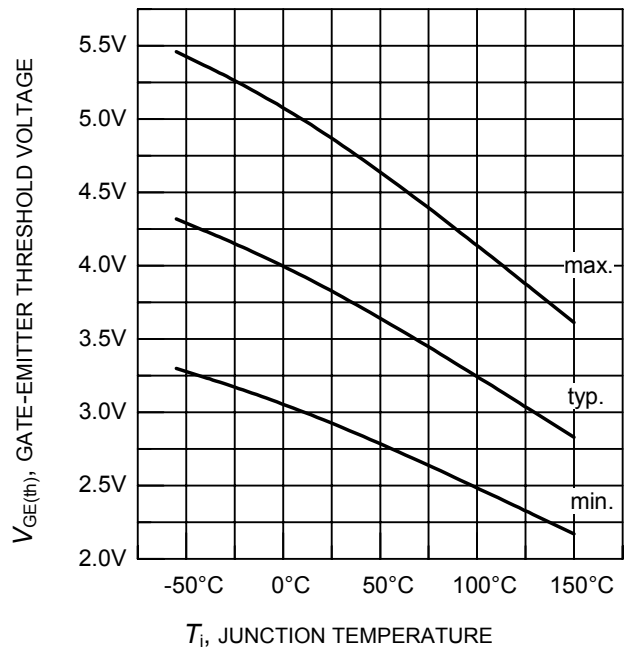

**Figure 12. Gate-emitter threshold voltage as a function of junction temperature**  
( $I_C = 0.7\text{mA}$ )

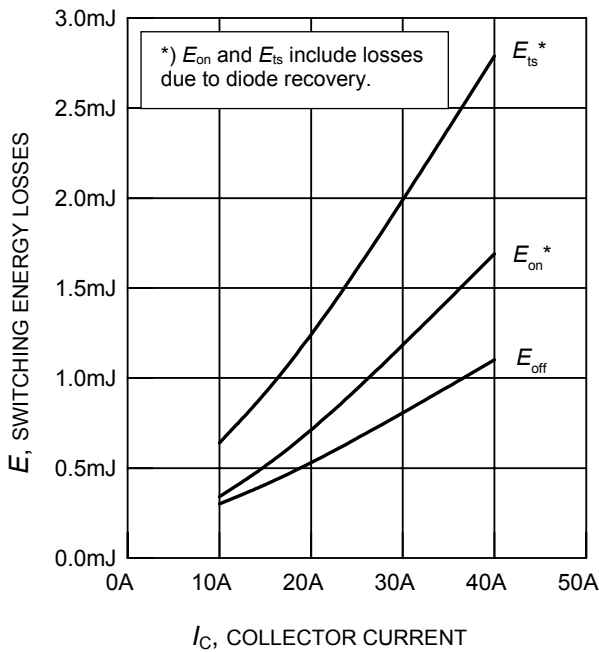

**Figure 13. Typical switching energy losses as a function of collector current**  
(inductive load,  $T_j = 150^\circ\text{C}$ ,  $V_{CE} = 400\text{V}$ ,  $V_{GE} = 0/+15\text{V}$ ,  $R_G = 16\Omega$ , Dynamic test circuit in Figure E)

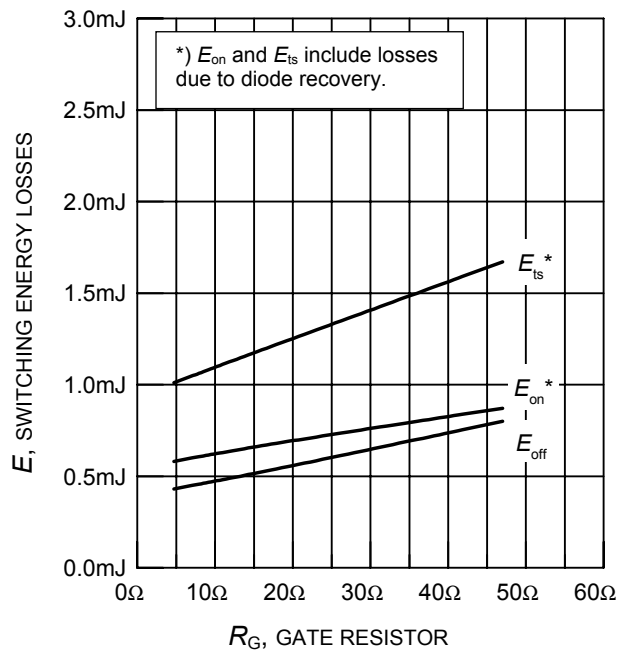

**Figure 14. Typical switching energy losses as a function of gate resistor**  
(inductive load,  $T_j = 150^\circ\text{C}$ ,  $V_{CE} = 400\text{V}$ ,  $V_{GE} = 0/+15\text{V}$ ,  $I_C = 20\text{A}$ , Dynamic test circuit in Figure E)

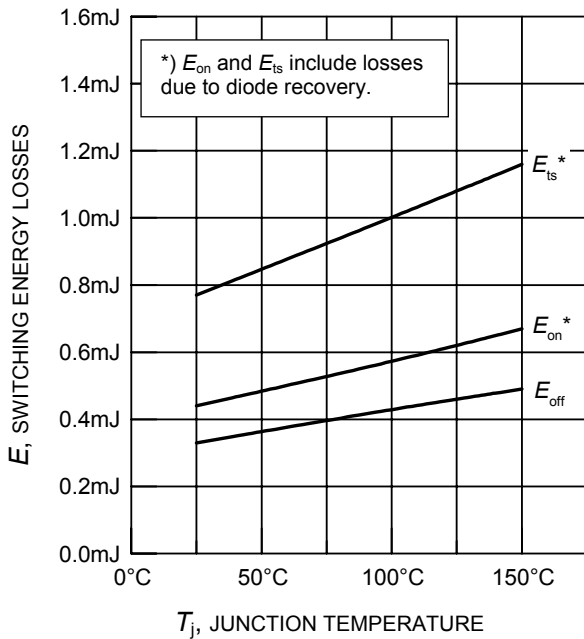

**Figure 15. Typical switching energy losses as a function of junction temperature**  
(inductive load,  $V_{CE} = 400\text{V}$ ,  $V_{GE} = 0/+15\text{V}$ ,  $I_C = 20\text{A}$ ,  $R_G = 16\Omega$ , Dynamic test circuit in Figure E)

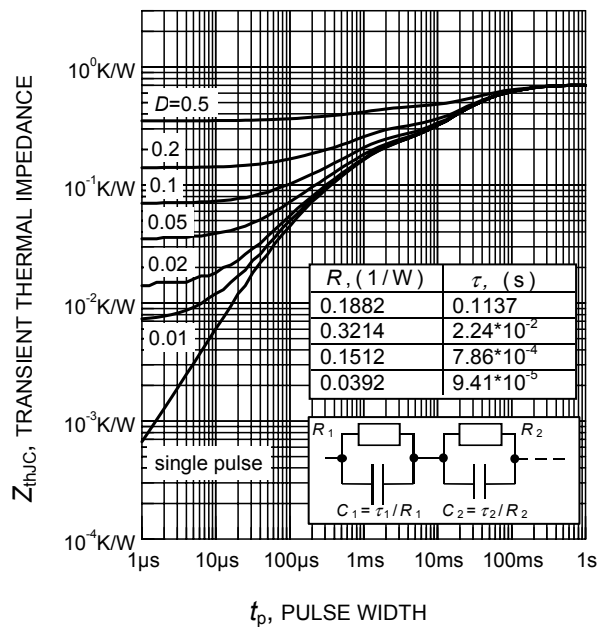

**Figure 16. IGBT transient thermal impedance as a function of pulse width**  
( $D = t_p / T$ )

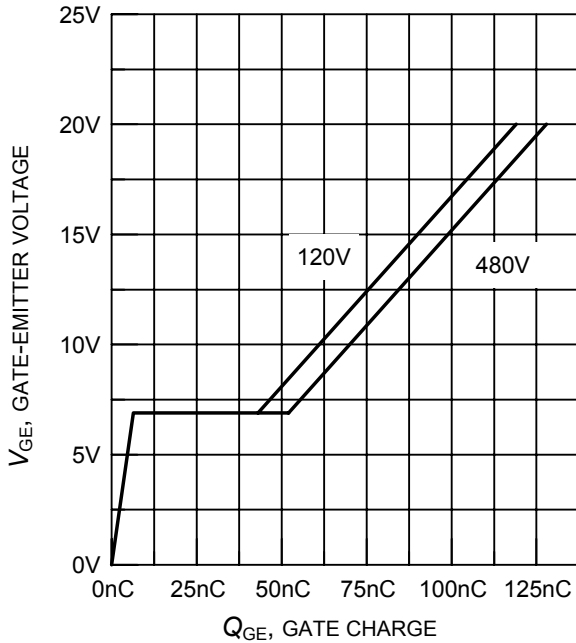

**Figure 17. Typical gate charge**  
( $I_C = 20A$ )

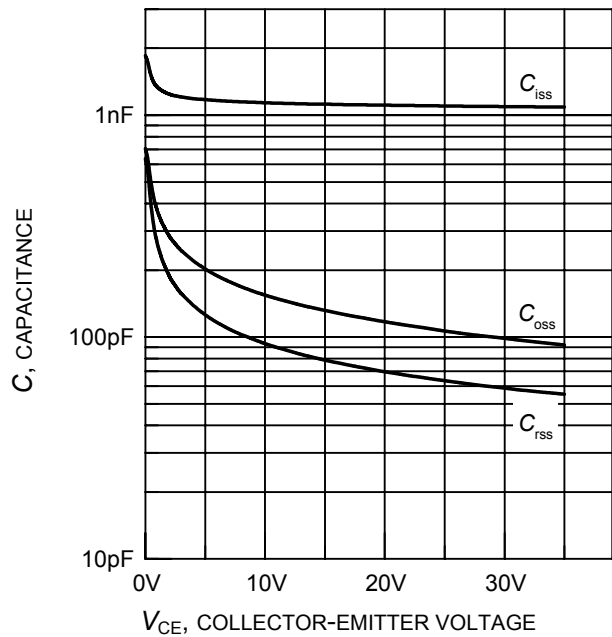

**Figure 18. Typical capacitance as a function of collector-emitter voltage**  
( $V_{GE} = 0V, f = 1MHz$ )

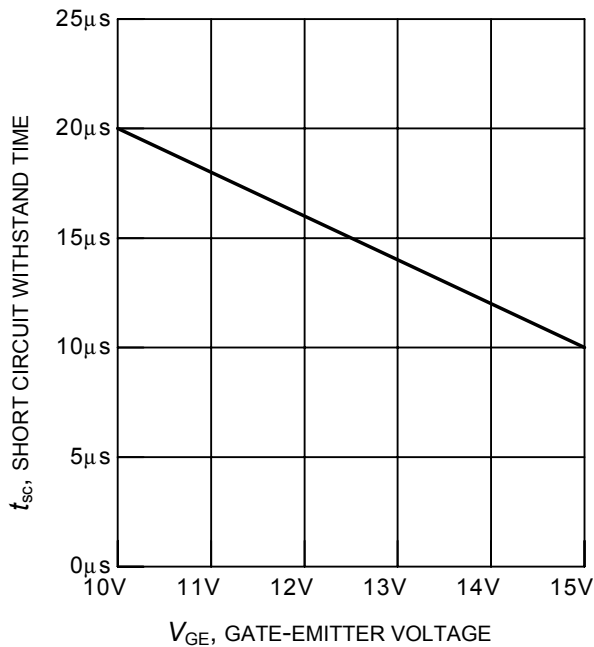

**Figure 19. Short circuit withstand time as a function of gate-emitter voltage**  
( $V_{CE} = 600V$ , start at  $T_j = 25^\circ C$ )

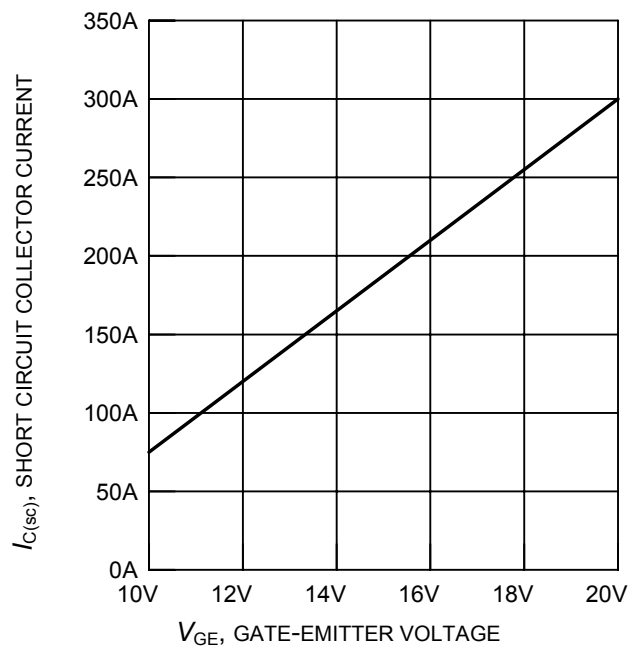

**Figure 20. Typical short circuit collector current as a function of gate-emitter voltage**  
( $V_{CE} \leq 600V, T_j = 150^\circ C$ )



PG-TO220-3-1

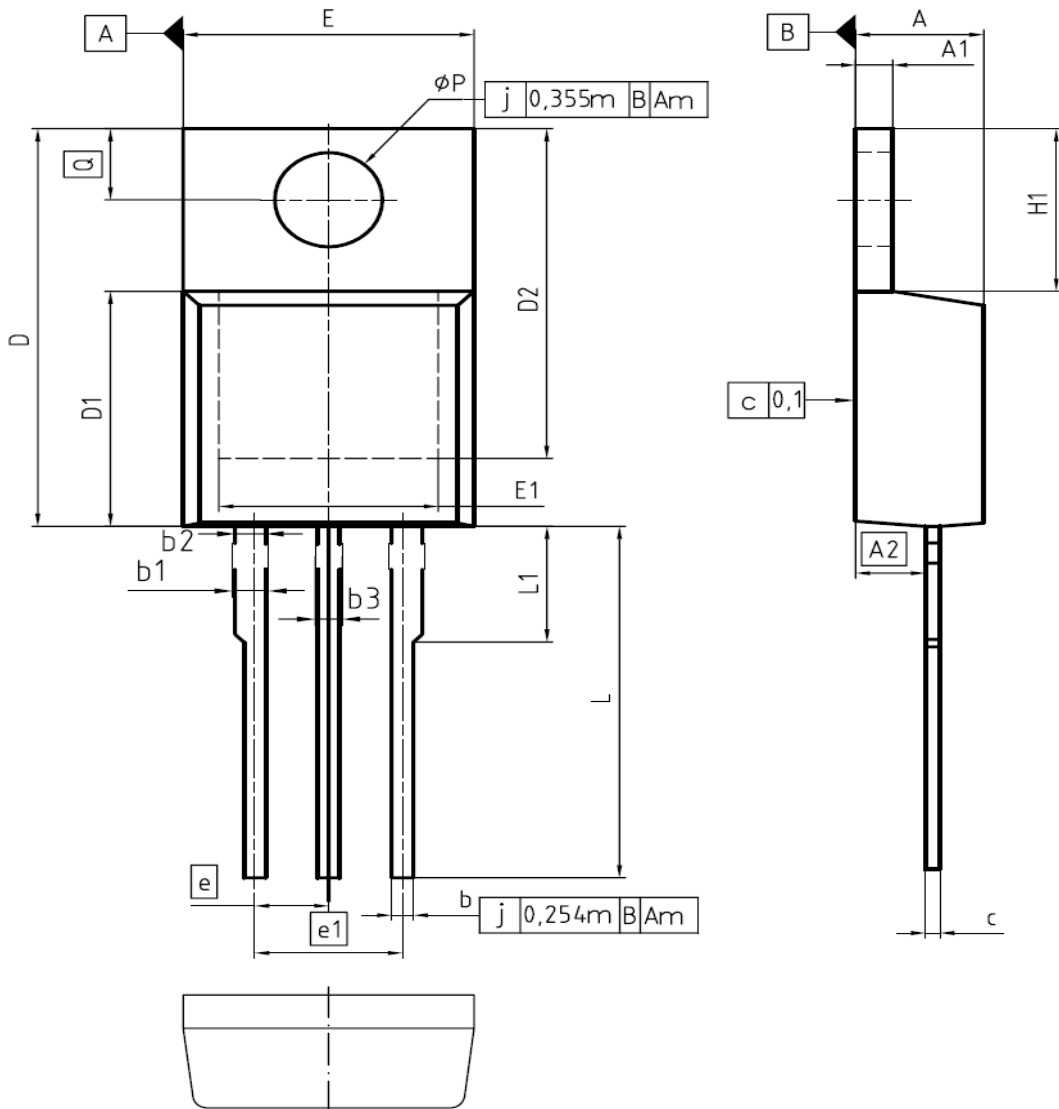

DIM	MILLIMETERS		INCHES	
	MIN	MAX	MIN	MAX
A	4.30	4.57	0.169	0.180
A1	1.17	1.40	0.046	0.055
A2	2.15	2.72	0.085	0.107
b	0.65	0.86	0.026	0.034
b1	0.95	1.40	0.037	0.055
b2	0.95	1.15	0.037	0.045
b3	0.65	1.15	0.026	0.045
c	0.33	0.60	0.013	0.024
D	14.81	15.95	0.583	0.628
D1	8.51	9.45	0.335	0.372
D2	12.19	13.10	0.480	0.516
E	9.70	10.36	0.382	0.408
E1	6.50	8.60	0.256	0.339
e	2.54		0.100	
e1	5.08		0.200	
N	3		3	
H1	5.90	6.90	0.232	0.272
L	13.00	14.00	0.512	0.551
L1	-	4.80	-	0.189
øP	3.60	3.89	0.142	0.153
Q	2.60	3.00	0.102	0.118

DOCUMENT NO.  
Z8B00003318

SCALE

EUROPEAN PROJECTION

ISSUE DATE  
23-08-2007

REVISION  
05

PG-TO247-3

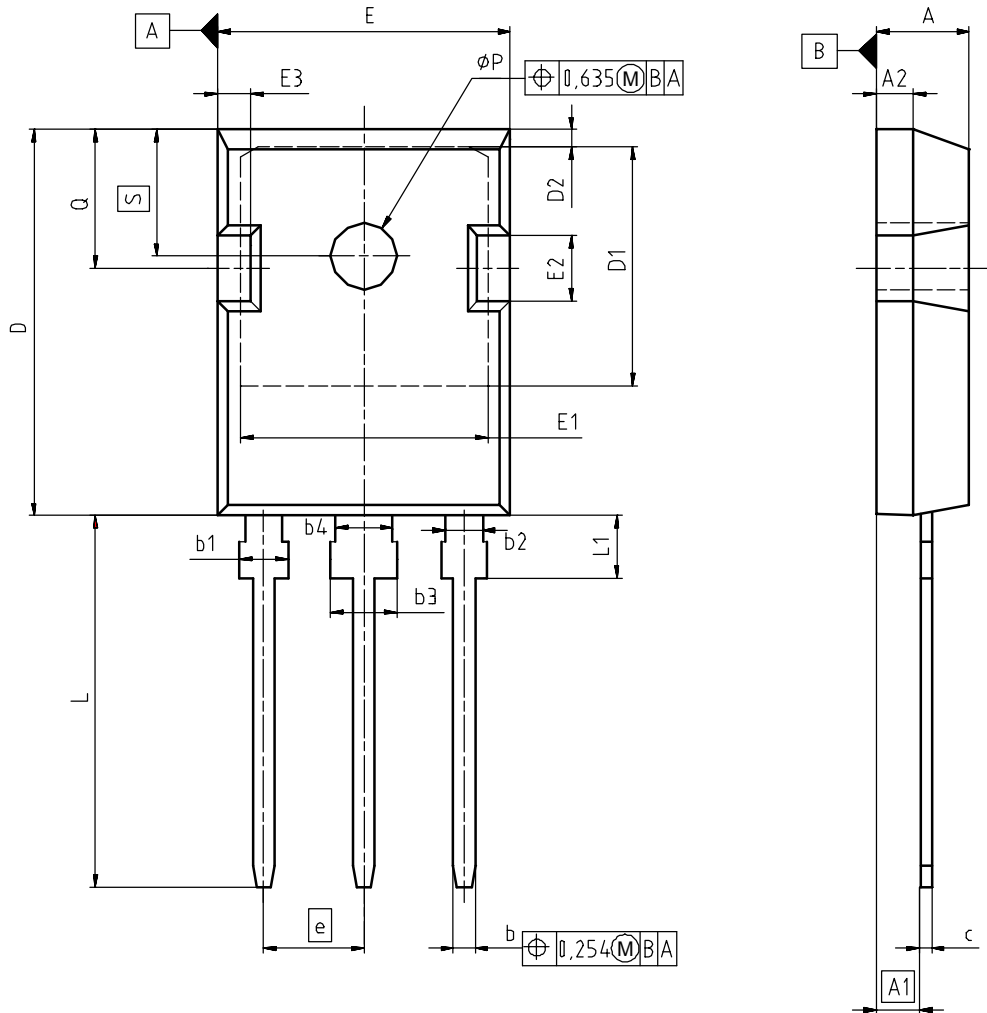

DIM	MILLIMETERS		INCHES	
	MIN	MAX	MIN	MAX
A	4.90	5.16	0.193	0.203
A1	2.27	2.53	0.089	0.099
A2	1.85	2.11	0.073	0.083
b	1.07	1.33	0.042	0.052
b1	1.90	2.41	0.075	0.095
b2	1.90	2.16	0.075	0.085
b3	2.87	3.38	0.113	0.133
b4	2.87	3.13	0.113	0.123
c	0.55	0.68	0.022	0.027
D	20.82	21.10	0.820	0.831
D1	16.25	17.65	0.640	0.695
D2	1.05	1.35	0.041	0.053
E	15.70	16.03	0.618	0.631
E1	13.10	14.15	0.516	0.557
E2	3.68	5.10	0.145	0.201
E3	1.68	2.60	0.066	0.102
e	5.44		0.214	
N	3		3	
L	19.80	20.31	0.780	0.799
L1	4.17	4.47	0.164	0.176
$\phi P$	3.50	3.70	0.138	0.146
Q	5.49	6.00	0.216	0.236
S	6.04	6.30	0.238	0.248

DOCUMENT NO.  
Z8B00003327

SCALE

EUROPEAN PROJECTION

ISSUE DATE  
17-12-2007

REVISION  
03

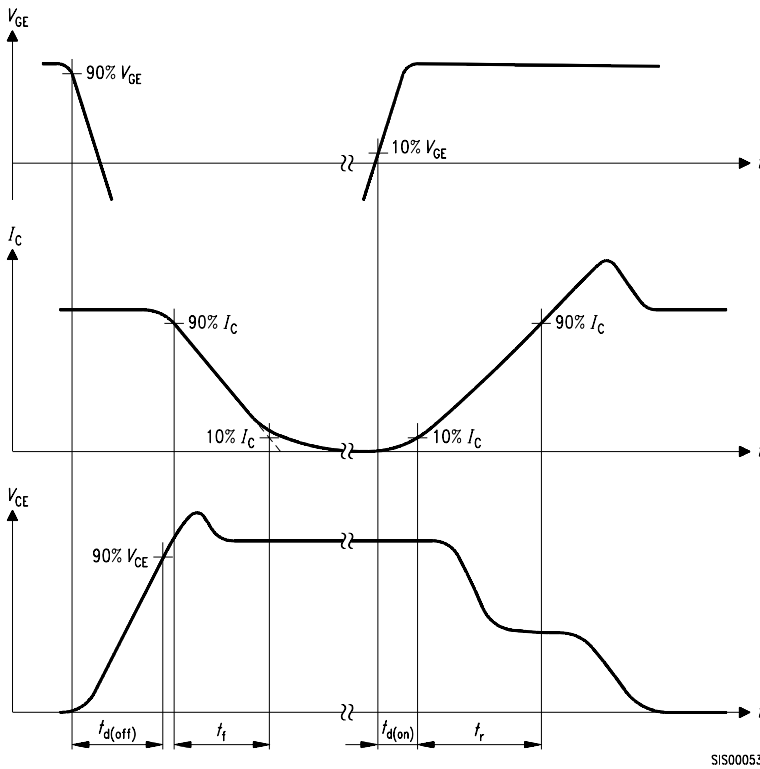

**Figure A. Definition of switching times**

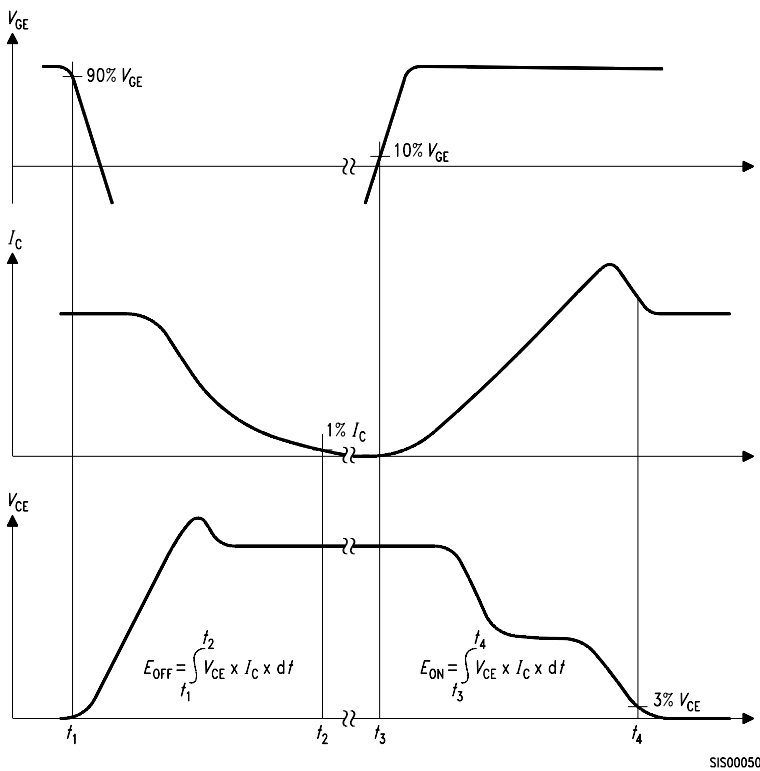

**Figure B. Definition of switching losses**

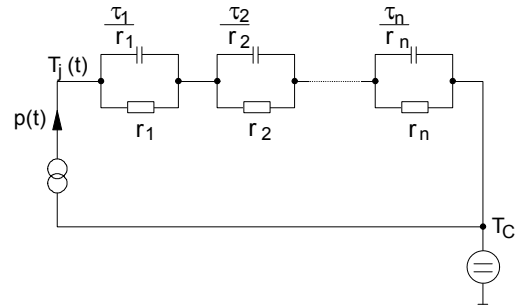

**Figure D. Thermal equivalent circuit**

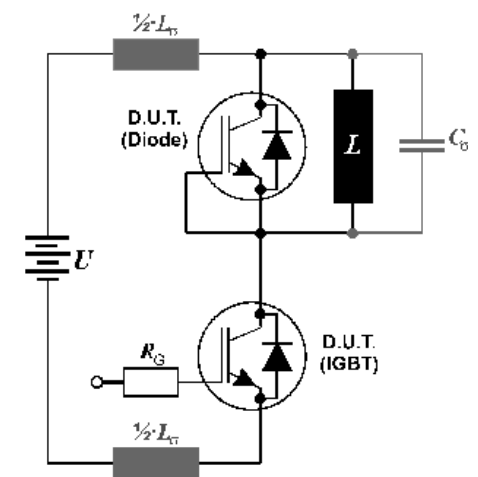

**Figure E. Dynamic test circuit**  
Leakage inductance  $L_{\sigma} = 180\text{nH}$   
and Stray capacity  $C_{\sigma} = 900\text{pF}$ .

**Published by**  
**Infineon Technologies AG**  
**81726 Munich, Germany**  
**© 2008 Infineon Technologies AG**  
**All Rights Reserved.**

### **Legal Disclaimer**

The information given in this document shall in no event be regarded as a guarantee of conditions or characteristics. With respect to any examples or hints given herein, any typical values stated herein and/or any information regarding the application of the device, Infineon Technologies hereby disclaims any and all warranties and liabilities of any kind, including without limitation, warranties of non-infringement of intellectual property rights of any third party.

### **Information**

For further information on technology, delivery terms and conditions and prices, please contact the nearest Infineon Technologies Office ([www.infineon.com](http://www.infineon.com)).

### **Warnings**

Due to technical requirements, components may contain dangerous substances. For information on the types in question, please contact the nearest Infineon Technologies Office. Infineon Technologies components may be used in life-support devices or systems only with the express written approval of Infineon Technologies, if a failure of such components can reasonably be expected to cause the failure of that life-support device or system or to affect the safety or effectiveness of that device or system. Life support devices or systems are intended to be implanted in the human body or to support and/or maintain and sustain and/or protect human life. If they fail, it is reasonable to assume that the health of the user or other persons may be endangered.