

Fast IGBT in NPT-technology with soft, fast recovery anti-parallel Emitter Controlled Diode

- 75% lower E_{off} compared to previous generation combined with low conduction losses
- Short circuit withstand time – 10 μ s
- Designed for frequency inverters for washing machines, fans, pumps and vacuum cleaners
- NPT-Technology for 600V applications offers:
 - very tight parameter distribution
 - high ruggedness, temperature stable behaviour
 - parallel switching capability
- Very soft, fast recovery anti-parallel Emitter Controlled Diode
- Qualified according to JEDEC¹ for target applications
- Pb-free lead plating; RoHS compliant
- Complete product spectrum and PSpice Models : <http://www.infineon.com/igbt/>

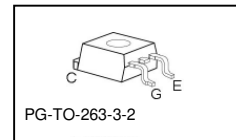
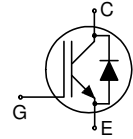

Type	V_{CE}	I_C	$V_{CE(sat)}$	T_j	Marking	Package
SKB04N60	600V	4A	2.3V	150°C	K04N60	PG-TO-263-3-2

Maximum Ratings

Parameter	Symbol	Value	Unit
Collector-emitter voltage	V_{CE}	600	V
DC collector current	I_C	9.4	A
$T_C = 25^\circ\text{C}$		9.4	
$T_C = 100^\circ\text{C}$		4.9	
Pulsed collector current, t_p limited by T_{jmax}	I_{Cpuls}	19	
Turn off safe operating area $V_{CE} \leq 600\text{V}$, $T_j \leq 150^\circ\text{C}$	-	19	
Diode forward current	I_F	10	
$T_C = 25^\circ\text{C}$		10	
$T_C = 100^\circ\text{C}$		4	
Diode pulsed current, t_p limited by T_{jmax}	I_{Fpuls}	19	
Gate-emitter voltage	V_{GE}	± 20	V
Short circuit withstand time ²	t_{SC}	10	μ s
$V_{GE} = 15\text{V}$, $V_{CC} \leq 600\text{V}$, $T_j \leq 150^\circ\text{C}$			
Power dissipation	P_{tot}	50	W
$T_C = 25^\circ\text{C}$			
Operating junction and storage temperature	T_j , T_{stg}	-55...+150	$^\circ\text{C}$
Soldering temperature (reflow soldering, MSL1)	T_s	260	$^\circ\text{C}$

¹ J-STD-020 and JESD-022

² Allowed number of short circuits: <1000; time between short circuits: >1s.

Thermal Resistance

Parameter	Symbol	Conditions	Max. Value	Unit
Characteristic				
IGBT thermal resistance, junction – case	R_{thJC}		2.5	K/W
Diode thermal resistance, junction – case	R_{thJCD}		4.5	
SMD version, device on PCB ¹⁾	R_{thJA}		40	

Electrical Characteristic, at $T_j = 25\text{ °C}$, unless otherwise specified

Parameter	Symbol	Conditions	Value			Unit
			min.	Typ.	max.	
Static Characteristic						
Collector-emitter breakdown voltage	$V_{(BR)CES}$	$V_{GE}=0V, I_C=500\mu A$	600	-	-	V
Collector-emitter saturation voltage	$V_{CE(sat)}$	$V_{GE} = 15V, I_C=4A$ $T_j=25\text{ °C}$ $T_j=150\text{ °C}$	1.7 -	2.0 2.3	2.4 2.8	
Diode forward voltage	V_F	$V_{GE}=0V, I_F=4A$ $T_j=25\text{ °C}$ $T_j=150\text{ °C}$	1.2 -	1.4 1.25	1.8 1.65	
Gate-emitter threshold voltage	$V_{GE(th)}$	$I_C=200\mu A, V_{CE}=V_{GE}$	3	4	5	
Zero gate voltage collector current	I_{CES}	$V_{CE}=600V, V_{GE}=0V$ $T_j=25\text{ °C}$ $T_j=150\text{ °C}$	- -	- -	20 500	μA
Gate-emitter leakage current	I_{GES}	$V_{CE}=0V, V_{GE}=20V$	-	-	100	nA
Transconductance	g_{fs}	$V_{CE}=20V, I_C=4A$		3.1	-	S
Dynamic Characteristic						
Input capacitance	C_{iss}	$V_{CE}=25V,$ $V_{GE}=0V,$ $f=1\text{ MHz}$	-	264	317	pF
Output capacitance	C_{oss}		-	29	35	
Reverse transfer capacitance	C_{rss}		-	17	20	
Gate charge	Q_{Gate}	$V_{CC}=480V, I_C=4A$ $V_{GE}=15V$	-	24	31	nC
Internal emitter inductance measured 5mm (0.197 in.) from case	L_E		-	7	-	nH
Short circuit collector current ²⁾	$I_{C(SC)}$	$V_{GE}=15V, t_{SC}\leq 10\mu s$ $V_{CC}\leq 600V,$ $T_j\leq 150\text{ °C}$	-	40	-	A

¹⁾ Device on 50mm*50mm*1.5mm epoxy PCB FR4 with 6cm² (one layer, 70 μ m thick) copper area for collector connection. PCB is vertical without blown air.

²⁾ Allowed number of short circuits: <1000; time between short circuits: >1s.

Switching Characteristic, Inductive Load, at $T_j=25\text{ }^\circ\text{C}$

Parameter	Symbol	Conditions	Value			Unit
			min.	typ.	max.	
IGBT Characteristic						
Turn-on delay time	$t_{d(on)}$	$T_j=25\text{ }^\circ\text{C}$, $V_{CC}=400\text{V}$, $I_C=4\text{A}$, $V_{GE}=0/15\text{V}$, $R_G=67\Omega$, $L_{\sigma}^{1)}=180\text{nH}$, $C_{\sigma}^{1)}=180\text{pF}$ Energy losses include "tail" and diode reverse recovery.	-	22	26	ns
Rise time	t_r		-	15	18	
Turn-off delay time	$t_{d(off)}$		-	237	284	
Fall time	t_f		-	70	84	
Turn-on energy	E_{on}		-	0.070	0.081	mJ
Turn-off energy	E_{off}		-	0.061	0.079	
Total switching energy	E_{ts}		-	0.131	0.160	
Anti-Parallel Diode Characteristic						
Diode reverse recovery time	t_{rr}	$T_j=25\text{ }^\circ\text{C}$, $V_R=200\text{V}$, $I_F=4\text{A}$, $di_F/dt=200\text{A}/\mu\text{s}$	-	180	-	ns
	t_S		-	15	-	
	t_F		-	165	-	
Diode reverse recovery charge	Q_{rr}		-	130	-	nC
Diode peak reverse recovery current	I_{rrm}		-	2.5	-	A
Diode peak rate of fall of reverse recovery current during t_b	di_{rr}/dt		-	180	-	A/ μs

Switching Characteristic, Inductive Load, at $T_j=150\text{ }^\circ\text{C}$

Parameter	Symbol	Conditions	Value			Unit
			min.	typ.	max.	
IGBT Characteristic						
Turn-on delay time	$t_{d(on)}$	$T_j=150\text{ }^\circ\text{C}$ $V_{CC}=400\text{V}$, $I_C=4\text{A}$, $V_{GE}=0/15\text{V}$, $R_G=67\Omega$, $L_{\sigma}^{1)}=180\text{nH}$, $C_{\sigma}^{1)}=180\text{pF}$ Energy losses include "tail" and diode reverse recovery.	-	22	26	ns
Rise time	t_r		-	16	19	
Turn-off delay time	$t_{d(off)}$		-	264	317	
Fall time	t_f		-	104	125	
Turn-on energy	E_{on}		-	0.115	0.132	mJ
Turn-off energy	E_{off}		-	0.111	0.144	
Total switching energy	E_{ts}		-	0.226	0.277	
Anti-Parallel Diode Characteristic						
Diode reverse recovery time	t_{rr}	$T_j=150\text{ }^\circ\text{C}$ $V_R=200\text{V}$, $I_F=4\text{A}$, $di_F/dt=200\text{A}/\mu\text{s}$	-	230	-	ns
	t_S		-	23	-	
	t_F		-	227	-	
Diode reverse recovery charge	Q_{rr}		-	300	-	nC
Diode peak reverse recovery current	I_{rrm}		-	4	-	A
Diode peak rate of fall of reverse recovery current during t_b	di_{rr}/dt		-	200	-	A/ μs

¹⁾ Leakage inductance L_{σ} and Stray capacity C_{σ} due to dynamic test circuit in Figure E.

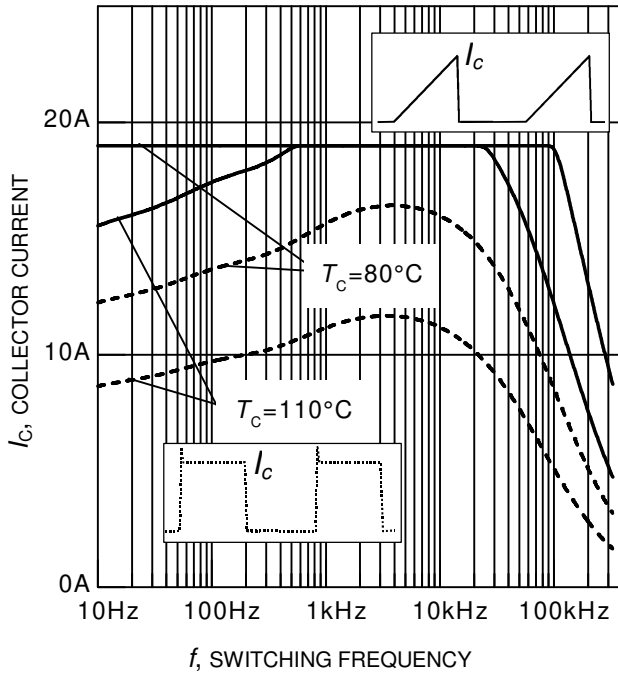

Figure 1. Collector current as a function of switching frequency
 ($T_j \leq 150^\circ\text{C}$, $D = 0.5$, $V_{CE} = 400\text{V}$,
 $V_{GE} = 0/+15\text{V}$, $R_G = 67\Omega$)

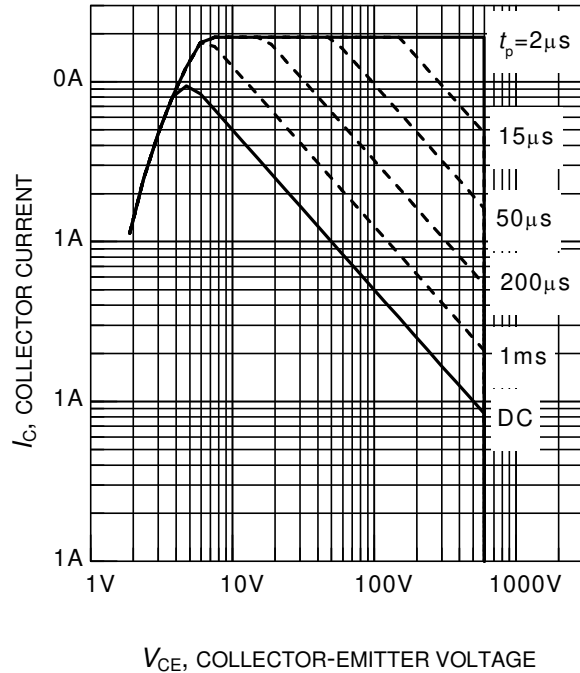

Figure 2. Safe operating area
 ($D = 0$, $T_C = 25^\circ\text{C}$, $T_j \leq 150^\circ\text{C}$)

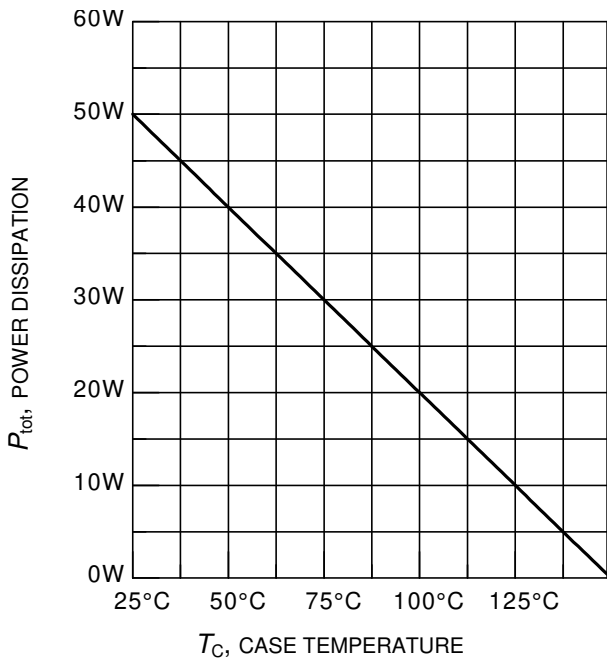

Figure 3. Power dissipation as a function of case temperature
 ($T_j \leq 150^\circ\text{C}$)

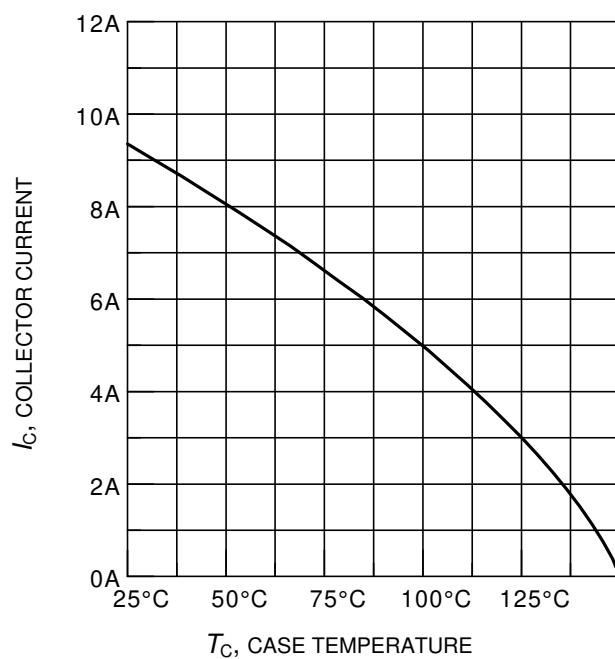

Figure 4. Collector current as a function of case temperature
 ($V_{GE} \leq 15\text{V}$, $T_j \leq 150^\circ\text{C}$)

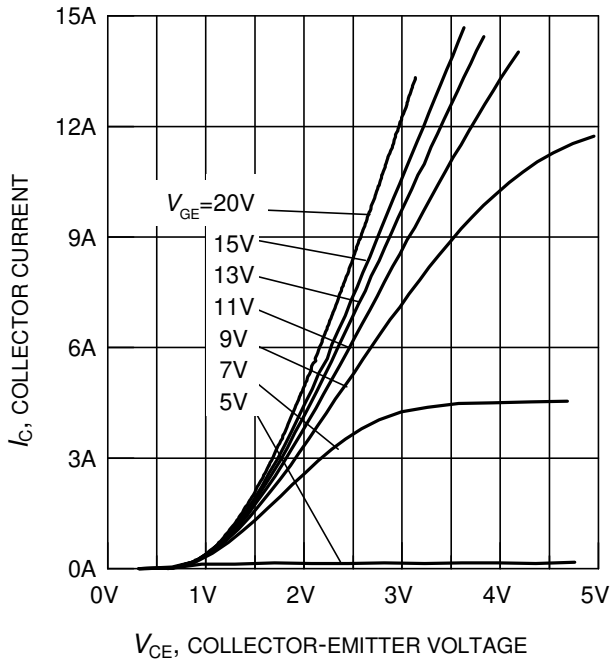

Figure 5. Typical output characteristics
($T_j = 25^\circ\text{C}$)

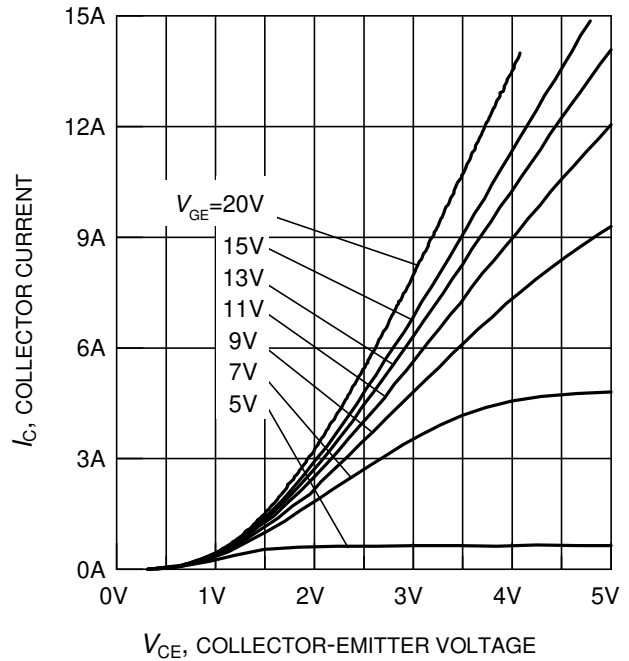

Figure 6. Typical output characteristics
($T_j = 150^\circ\text{C}$)

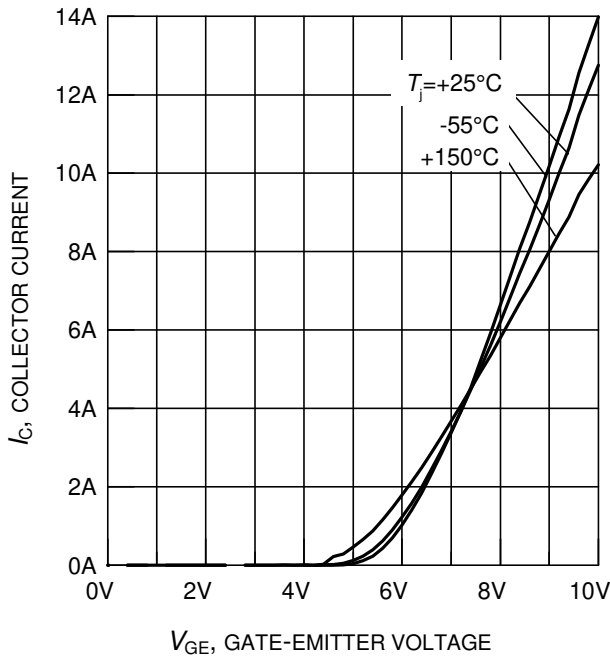

Figure 7. Typical transfer characteristics
($V_{CE} = 10\text{V}$)

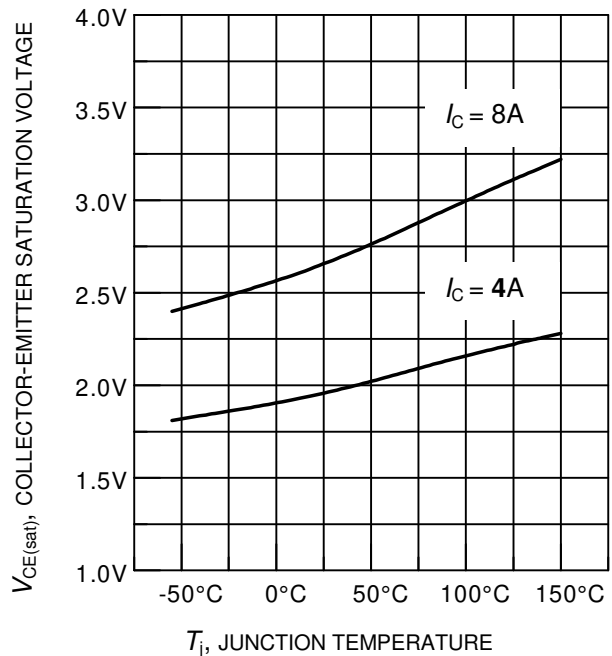

Figure 8. Typical collector-emitter saturation voltage as a function of junction temperature
($V_{GE} = 15\text{V}$)

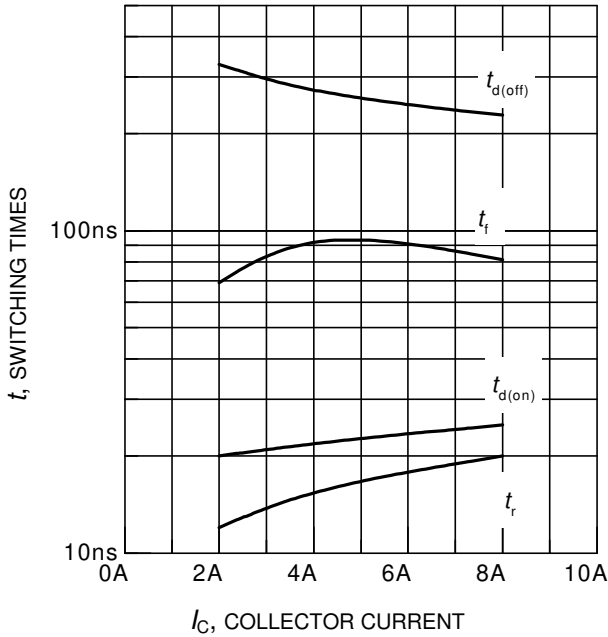

Figure 9. Typical switching times as a function of collector current
 (inductive load, $T_j = 150^\circ\text{C}$, $V_{CE} = 400\text{V}$,
 $V_{GE} = 0/+15\text{V}$, $R_G = 67\Omega$,
 Dynamic test circuit in Figure E)

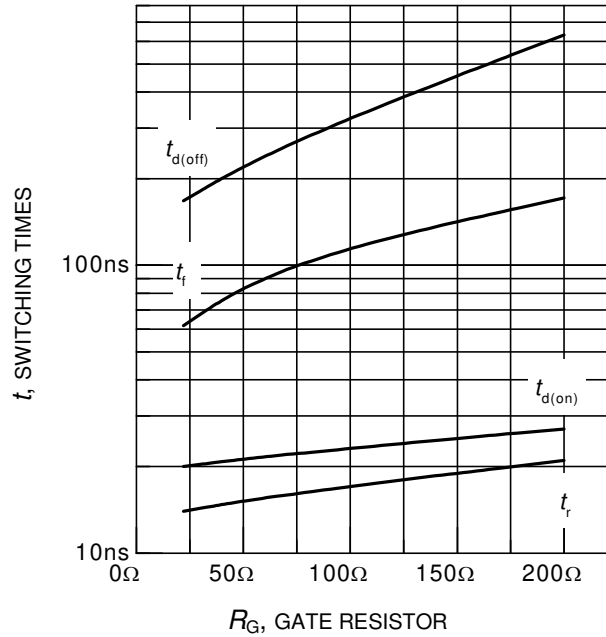

Figure 10. Typical switching times as a function of gate resistor
 (inductive load, $T_j = 150^\circ\text{C}$, $V_{CE} = 400\text{V}$,
 $V_{GE} = 0/+15\text{V}$, $I_C = 4\text{A}$,
 Dynamic test circuit in Figure E)

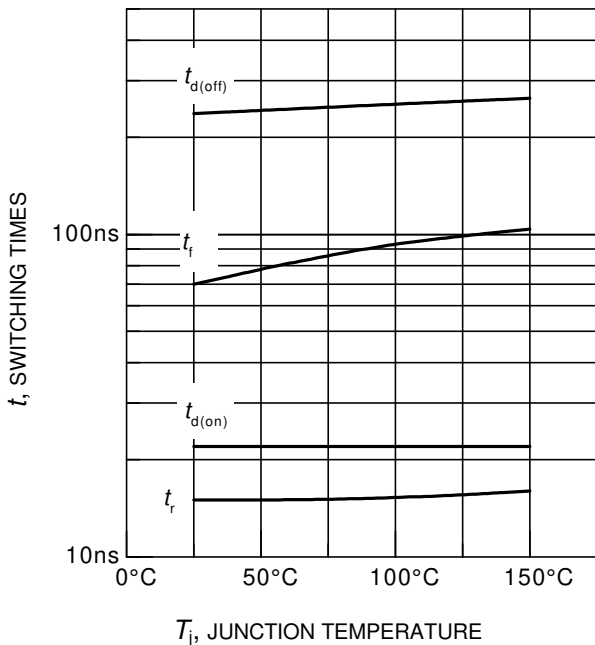

Figure 11. Typical switching times as a function of junction temperature
 (inductive load, $V_{CE} = 400\text{V}$, $V_{GE} = 0/+15\text{V}$,
 $I_C = 4\text{A}$, $R_G = 67\Omega$,
 Dynamic test circuit in Figure E)

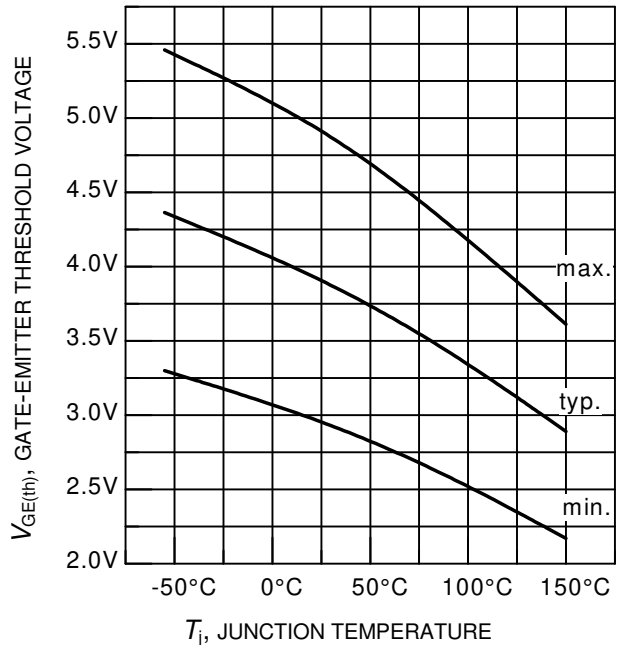

Figure 12. Gate-emitter threshold voltage as a function of junction temperature
 ($I_C = 0.2\text{mA}$)

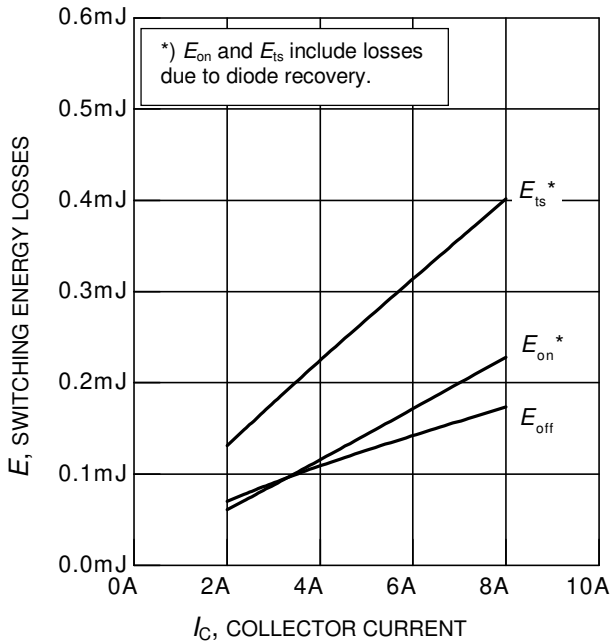

Figure 13. Typical switching energy losses as a function of collector current

(inductive load, $T_j = 150^\circ\text{C}$, $V_{CE} = 400\text{V}$, $V_{GE} = 0/+15\text{V}$, $R_G = 67\Omega$, Dynamic test circuit in Figure E)

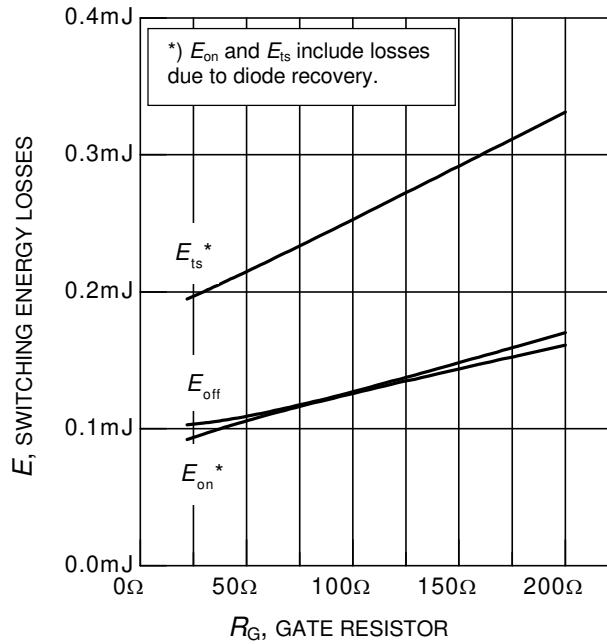

Figure 14. Typical switching energy losses as a function of gate resistor

(inductive load, $T_j = 150^\circ\text{C}$, $V_{CE} = 400\text{V}$, $V_{GE} = 0/+15\text{V}$, $I_C = 4\text{A}$, Dynamic test circuit in Figure E)

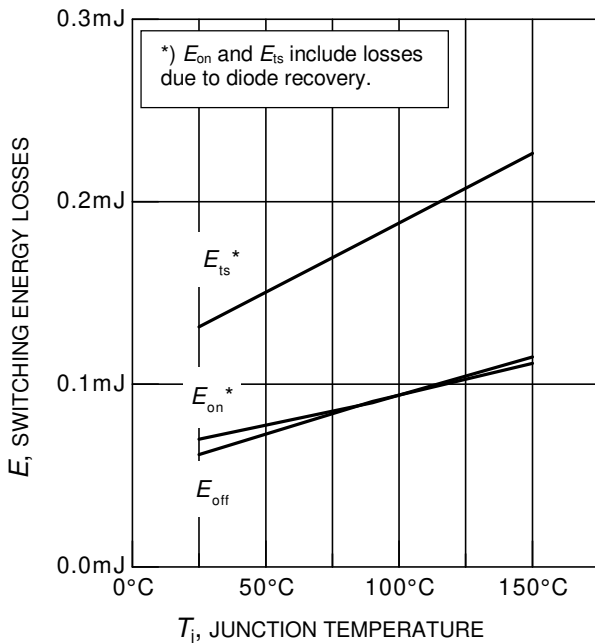

Figure 15. Typical switching energy losses as a function of junction temperature

(inductive load, $V_{CE} = 400\text{V}$, $V_{GE} = 0/+15\text{V}$, $I_C = 4\text{A}$, $R_G = 67\Omega$, Dynamic test circuit in Figure E)

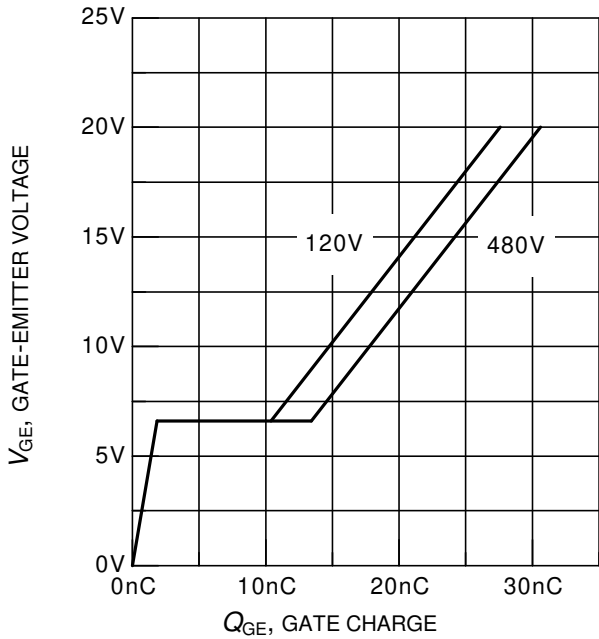

Figure 16. Typical gate charge
($I_C = 4A$)

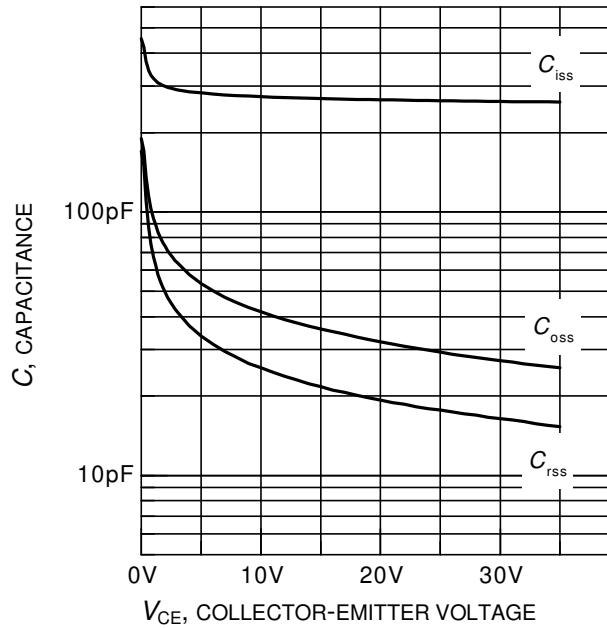

Figure 17. Typical capacitance as a function of collector-emitter voltage
($V_{GE} = 0V, f = 1MHz$)

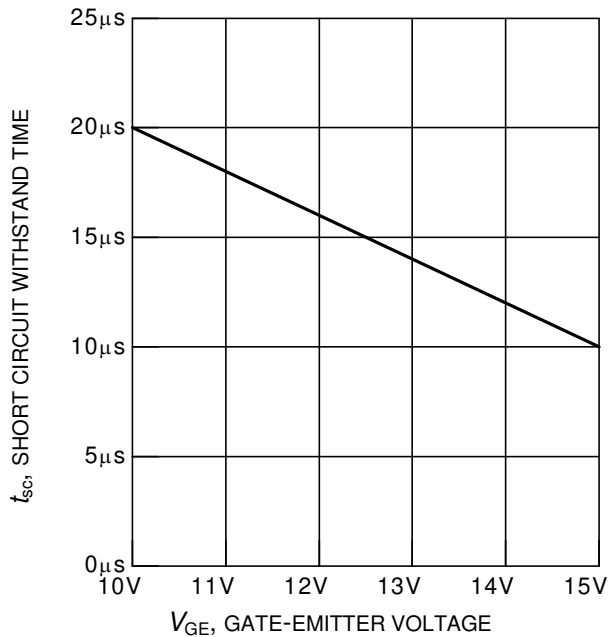

Figure 18. Short circuit withstand time as a function of gate-emitter voltage
($V_{CE} = 600V, \text{start at } T_j = 25^\circ C$)

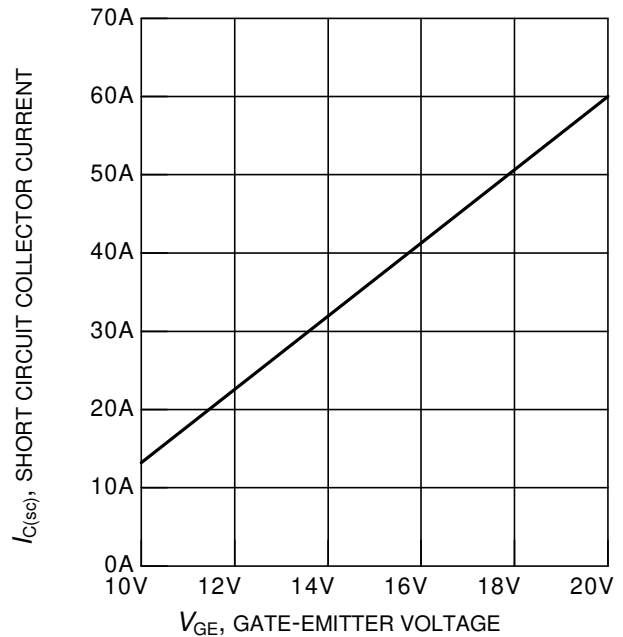

Figure 19. Typical short circuit collector current as a function of gate-emitter voltage
($V_{CE} \leq 600V, T_j = 150^\circ C$)

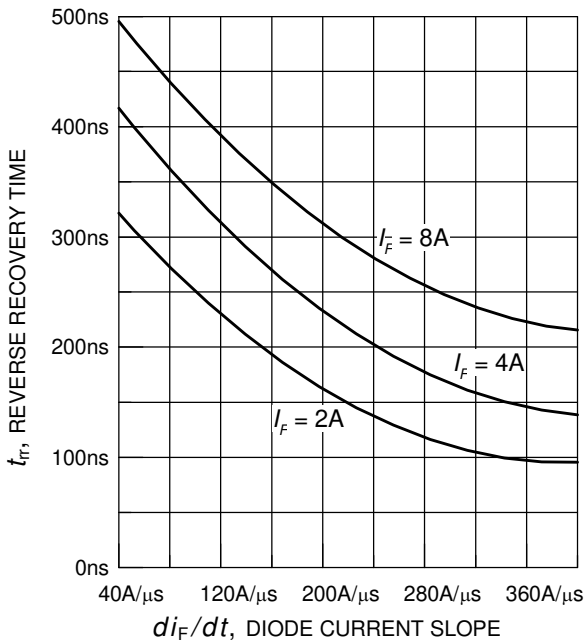

Figure 20. Typical reverse recovery time as a function of diode current slope
 ($V_R = 200V$, $T_j = 125^\circ C$,
 Dynamic test circuit in Figure E)

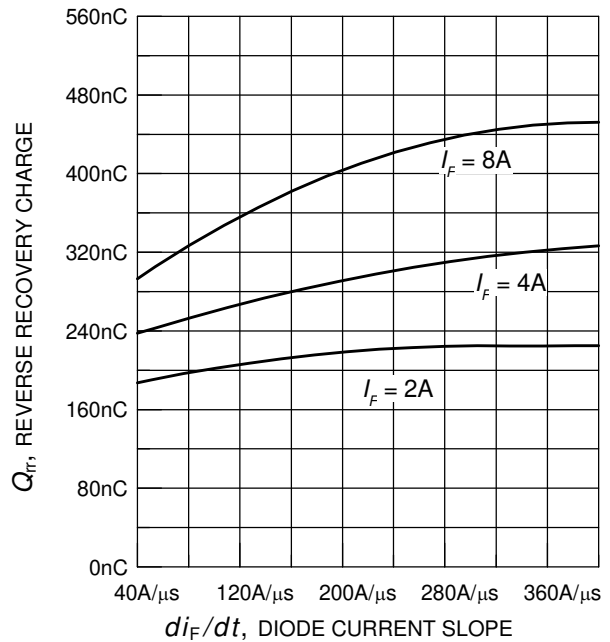

Figure 21. Typical reverse recovery charge as a function of diode current slope
 ($V_R = 200V$, $T_j = 125^\circ C$,
 Dynamic test circuit in Figure E)

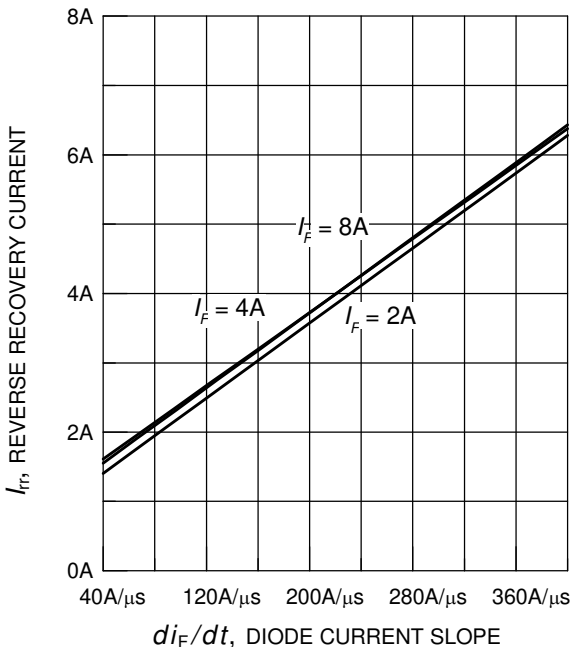

Figure 22. Typical reverse recovery current as a function of diode current slope
 ($V_R = 200V$, $T_j = 125^\circ C$,
 Dynamic test circuit in Figure E)

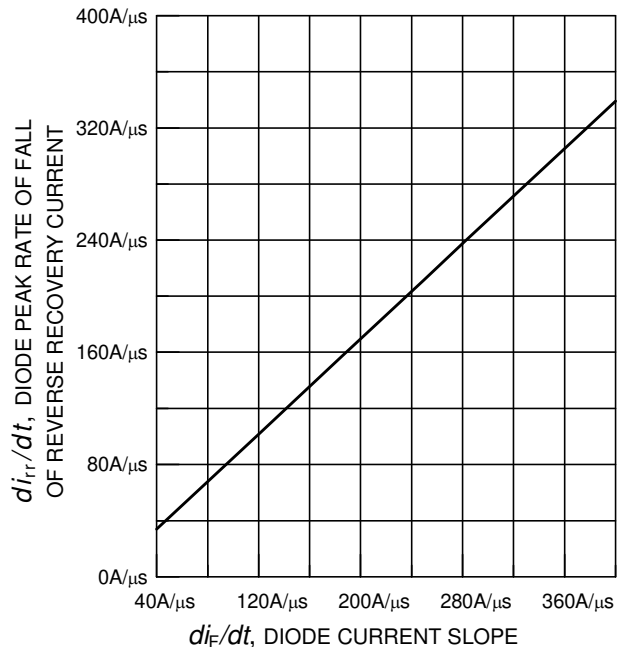

Figure 23. Typical diode peak rate of fall of reverse recovery current as a function of diode current slope
 ($V_R = 200V$, $T_j = 125^\circ C$,
 Dynamic test circuit in Figure E)

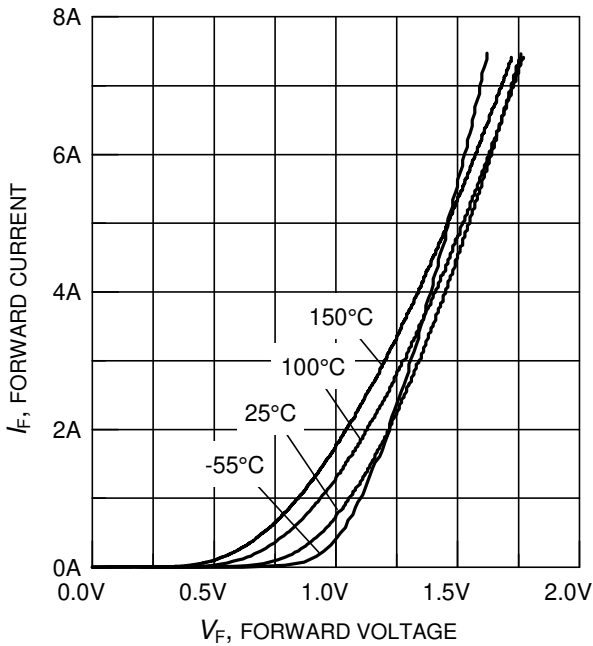

Figure 24. Typical diode forward current as a function of forward voltage

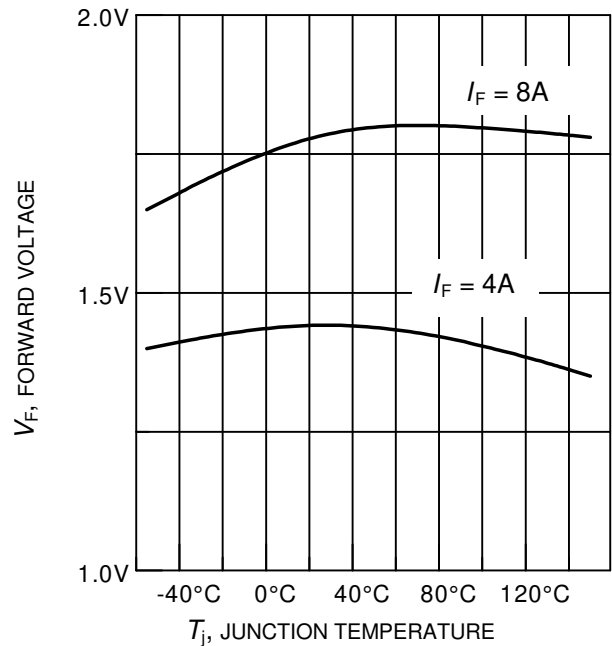

Figure 25. Typical diode forward voltage as a function of junction temperature

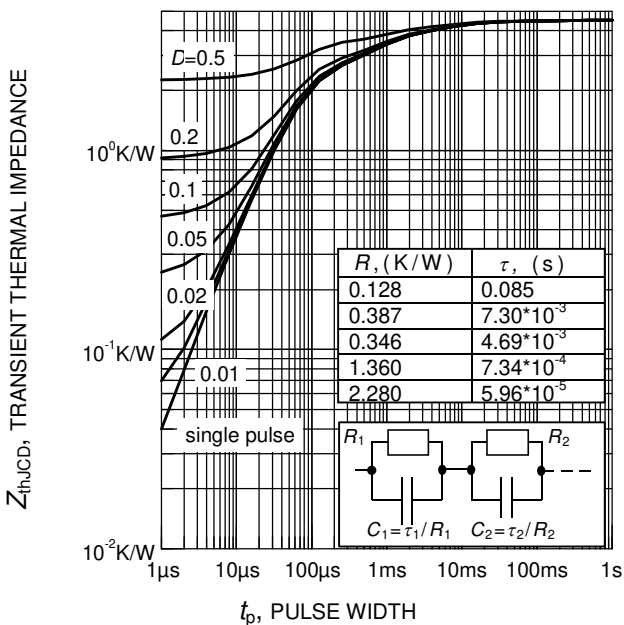

Figure 26. Diode transient thermal impedance as a function of pulse width ($D = t_p / T$)

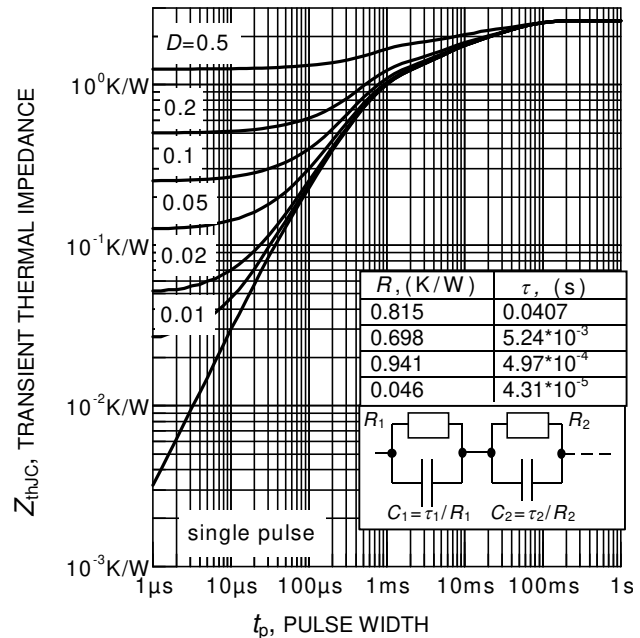
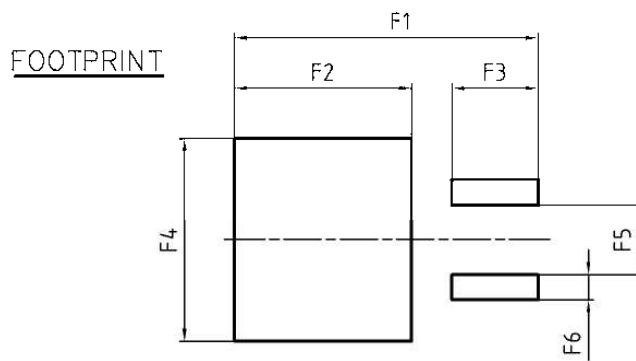
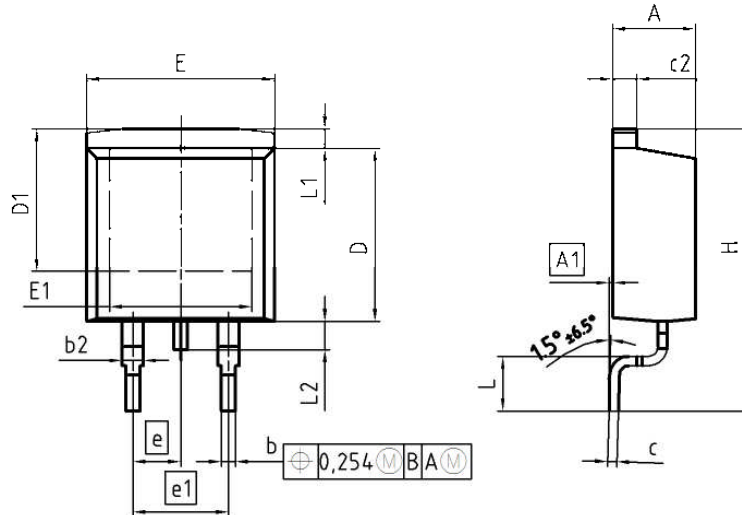

Figure 28. IGBT transient thermal impedance as a function of pulse width ($D = t_p / T$)

PG-TO263-3-2



DIM	MILLIMETERS		INCHES	
	MIN	MAX	MIN	MAX
A	4.30	4.57	0.169	0.180
A1	0.00	0.25	0.000	0.010
b	0.65	0.85	0.026	0.033
b2	0.95	1.15	0.037	0.045
c	0.33	0.65	0.013	0.026
c2	1.17	1.40	0.046	0.055
D	8.51	9.45	0.335	0.372
D1	7.10	7.90	0.280	0.311
E	9.80	10.31	0.386	0.406
E1	6.50	8.60	0.256	0.339
e	2.54		0.100	
e1	5.08		0.200	
N	2		2	
H	14.61	15.88	0.575	0.625
L	2.29	3.00	0.090	0.118
L1	0.70	1.60	0.028	0.063
L2	1.00	1.78	0.039	0.070
F1	16.05	16.25	0.632	0.640
F2	9.30	9.50	0.366	0.374
F3	4.50	4.70	0.177	0.185
F4	10.70	10.90	0.421	0.429
F5	3.65	3.85	0.144	0.152
F6	1.25	1.45	0.049	0.057

DOCUMENT NO.
Z8B00003324

SCALE

EUROPEAN PROJECTION

ISSUE DATE
30-08-2007

REVISION
01

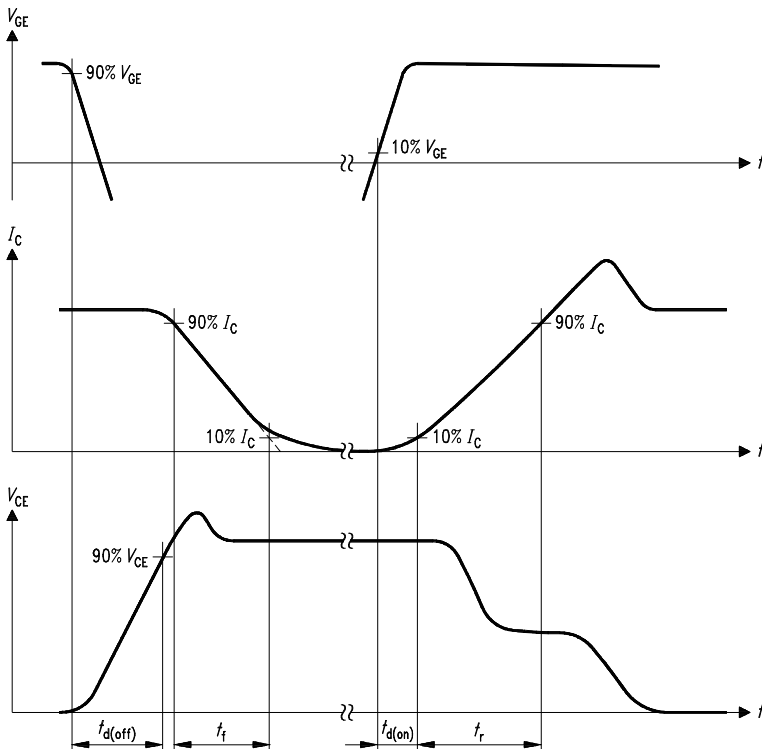

Figure A. Definition of switching times

SIS00053

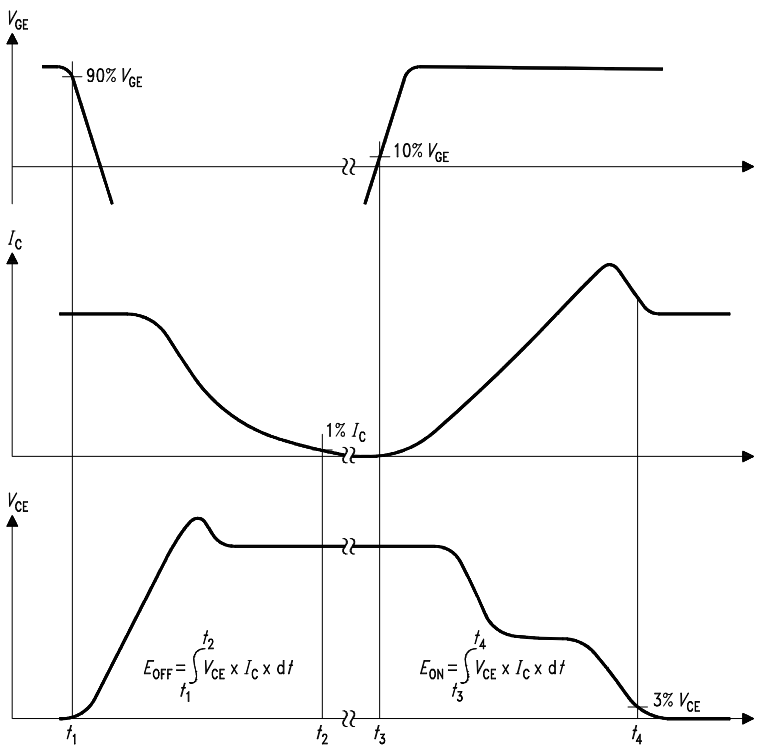

Figure B. Definition of switching losses

SIS00050

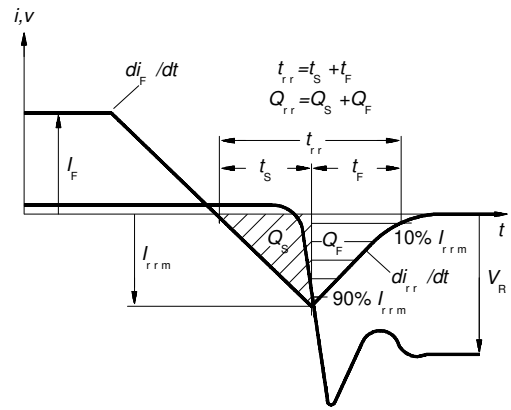

Figure C. Definition of diodes switching characteristics

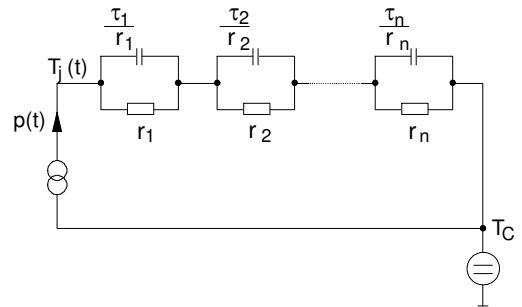

Figure D. Thermal equivalent circuit

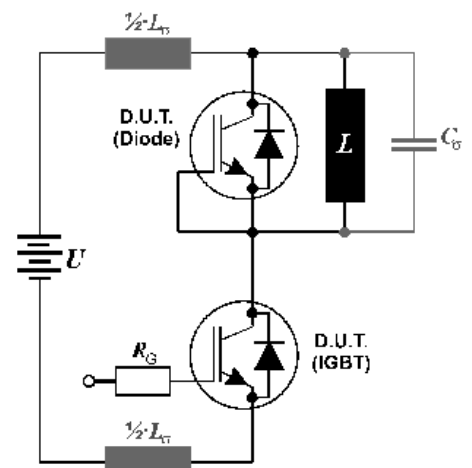

Figure E. Dynamic test circuit
Leakage inductance $L_{\sigma} = 180\text{nH}$
and Stray capacity $C_{\sigma} = 180\text{pF}$.

Published by
Infineon Technologies AG
81726 Munich, Germany
© 2013 Infineon Technologies AG
All Rights Reserved.

Legal Disclaimer

The information given in this document shall in no event be regarded as a guarantee of conditions or characteristics. With respect to any examples or hints given herein, any typical values stated herein and/or any information regarding the application of the device, Infineon Technologies hereby disclaims any and all warranties and liabilities of any kind, including without limitation, warranties of non-infringement of intellectual property rights of any third party.

Information

For further information on technology, delivery terms and conditions and prices, please contact the nearest Infineon Technologies Office (www.infineon.com).

Warnings

Due to technical requirements, components may contain dangerous substances. For information on the types in question, please contact the nearest Infineon Technologies Office.
The Infineon Technologies component described in this Data Sheet may be used in life-support devices or systems and/or automotive, aviation and aerospace applications or systems only with the express written approval of Infineon Technologies, if a failure of such components can reasonably be expected to cause the failure of that life-support, automotive, aviation and aerospace device or system or to affect the safety or effectiveness of that device or system. Life support devices or systems are intended to be implanted in the human body or to support and/or maintain and sustain and/or protect human life. If they fail, it is reasonable to assume that the health of the user or other persons may be endangered.