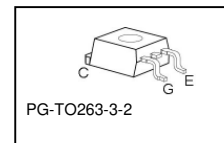
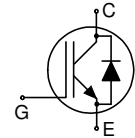


## Fast IGBT in NPT-technology with soft, fast recovery anti-parallel Emitter Controlled Diode

- 75% lower  $E_{off}$  compared to previous generation combined with low conduction losses
- Short circuit withstand time – 10  $\mu$ s
- Designed for frequency inverters for washing machines, fans, pumps and vacuum cleaners
- NPT-Technology for 600V applications offers:
  - very tight parameter distribution
  - high ruggedness, temperature stable behaviour
  - parallel switching capability
- Very soft, fast recovery anti-parallel Emitter Controlled Diode
- Pb-free lead plating; RoHS compliant
- Qualified according to JEDEC<sup>1</sup> for target applications
- Complete product spectrum and PSpice Models : <http://www.infineon.com/igbt/>



Type	$V_{CE}$	$I_C$	$V_{CE(sat)}$	$T_j$	Marking	Package
SKB15N60	600V	15A	2.3V	150°C	K15N60	PG-TO263-3-2

### Maximum Ratings

Parameter	Symbol	Value	Unit
Collector-emitter voltage	$V_{CE}$	600	V
DC collector current	$I_C$	31	A
$T_C = 25^\circ\text{C}$		15	
$T_C = 100^\circ\text{C}$			
Pulsed collector current, $t_p$ limited by $T_{jmax}$	$I_{Cpuls}$	62	
Turn off safe operating area $V_{CE} \leq 600\text{V}, T_j \leq 150^\circ\text{C}$	-	62	
Diode forward current	$I_F$	31	
$T_C = 25^\circ\text{C}$		15	
$T_C = 100^\circ\text{C}$			
Diode pulsed current, $t_p$ limited by $T_{jmax}$	$I_{Fpuls}$	62	
Gate-emitter voltage	$V_{GE}$	$\pm 20$	V
Short circuit withstand time <sup>2</sup> $V_{GE} = 15\text{V}, V_{CC} \leq 600\text{V}, T_j \leq 150^\circ\text{C}$	$t_{SC}$	10	$\mu$ s
Power dissipation $T_C = 25^\circ\text{C}$	$P_{tot}$	139	W
Operating junction and storage temperature	$T_j, T_{stg}$	-55...+150	$^\circ\text{C}$
Soldering temperature (reflow soldering, MSL1)	$T_s$	260	$^\circ\text{C}$

<sup>1</sup> J-STD-020 and JEDEC-022

<sup>2</sup> Allowed number of short circuits: <1000; time between short circuits: >1s.

**Thermal Resistance**

Parameter	Symbol	Conditions	Max. Value	Unit
<b>Characteristic</b>				
IGBT thermal resistance, junction – case	$R_{thJC}$		0.9	K/W
Diode thermal resistance, junction – case	$R_{thJCD}$		1.7	
SMD version, device on PCB <sup>1)</sup>	$R_{thJA}$		40	

**Electrical Characteristic, at  $T_j = 25\text{ °C}$ , unless otherwise specified**

Parameter	Symbol	Conditions	Value			Unit
			min.	Typ.	max.	
<b>Static Characteristic</b>						
Collector-emitter breakdown voltage	$V_{(BR)CES}$	$V_{GE}=0V, I_C=500\mu A$	600	-	-	V
Collector-emitter saturation voltage	$V_{CE(sat)}$	$V_{GE} = 15V, I_C=15A$ $T_j=25\text{ °C}$ $T_j=150\text{ °C}$	1.7 -	2 2.3	2.4 2.8	
Diode forward voltage	$V_F$	$V_{GE}=0V, I_F=15A$ $T_j=25\text{ °C}$ $T_j=150\text{ °C}$	1.2 -	1.4 1.25	1.8 1.65	
Gate-emitter threshold voltage	$V_{GE(th)}$	$I_C=400\mu A, V_{CE}=V_{GE}$	3	4	5	
Zero gate voltage collector current	$I_{CES}$	$V_{CE}=600V, V_{GE}=0V$ $T_j=25\text{ °C}$ $T_j=150\text{ °C}$	- -	- -	40 2000	$\mu A$
Gate-emitter leakage current	$I_{GES}$	$V_{CE}=0V, V_{GE}=20V$	-	-	100	nA
Transconductance	$g_{fs}$	$V_{CE}=20V, I_C=15A$	3	10.9	-	S
<b>Dynamic Characteristic</b>						
Input capacitance	$C_{iss}$	$V_{CE}=25V,$	-	800	960	pF
Output capacitance	$C_{oss}$	$V_{GE}=0V,$	-	84	101	
Reverse transfer capacitance	$C_{riss}$	$f=1\text{ MHz}$	-	52	62	
Gate charge	$Q_{Gate}$	$V_{CC}=480V, I_C=15A$ $V_{GE}=15V$	-	76	99	nC
Internal emitter inductance measured 5mm (0.197 in.) from case	$L_E$		-	7	-	nH
Short circuit collector current <sup>2)</sup>	$I_{C(SC)}$	$V_{GE}=15V, t_{SC}\leq 10\mu s$ $V_{CC}\leq 600V,$ $T_j\leq 150\text{ °C}$	-	150	-	A

<sup>1)</sup> Device on 50mm\*50mm\*1.5mm epoxy PCB FR4 with 6cm<sup>2</sup> (one layer, 70μm thick) copper area for collector connection. PCB is vertical without blown air.

<sup>2)</sup> Allowed number of short circuits: <1000; time between short circuits: >1s.

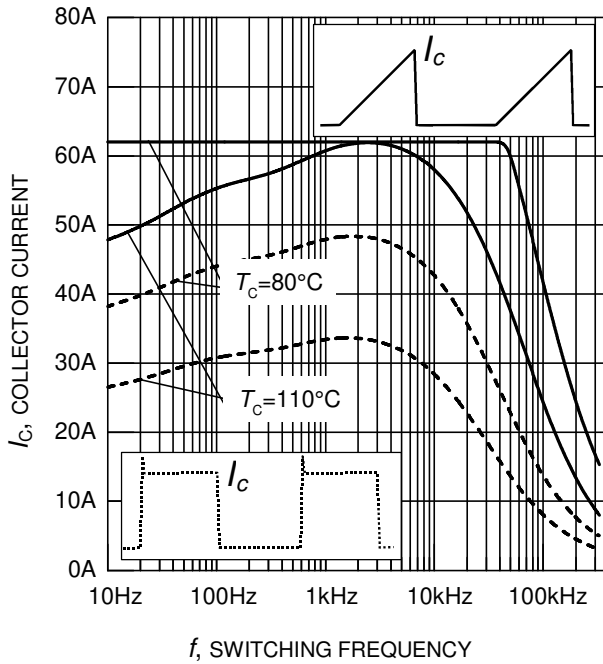
**Switching Characteristic, Inductive Load, at  $T_j=25\text{ }^\circ\text{C}$** 

Parameter	Symbol	Conditions	Value			Unit
			min.	typ.	max.	
<b>IGBT Characteristic</b>						
Turn-on delay time	$t_{d(on)}$	$T_j=25\text{ }^\circ\text{C}$ , $V_{CC}=400\text{V}$ , $I_C=15\text{A}$ , $V_{GE}=0/15\text{V}$ , $R_G=21\text{ }\Omega$ , $L_{\sigma}^{1)}$ = 180nH, $C_{\sigma}^{1)}$ = 250pF Energy losses include "tail" and diode reverse recovery.	-	32	38	ns
Rise time	$t_r$		-	23	28	
Turn-off delay time	$t_{d(off)}$		-	234	281	
Fall time	$t_f$		-	46	55	
Turn-on energy	$E_{on}$		-	0.30	0.36	mJ
Turn-off energy	$E_{off}$		-	0.27	0.35	
Total switching energy	$E_{ts}$		-	0.57	0.71	
<b>Anti-Parallel Diode Characteristic</b>						
Diode reverse recovery time	$t_{rr}$	$T_j=25\text{ }^\circ\text{C}$ , $V_R=200\text{V}$ , $I_F=15\text{A}$ , $di_F/dt=200\text{A}/\mu\text{s}$	-	279	-	ns
	$t_S$		-	28	-	
	$t_F$		-	254	-	
Diode reverse recovery charge	$Q_{rr}$		-	390	-	nC
Diode peak reverse recovery current	$I_{rrm}$		-	5.0	-	A
Diode peak rate of fall of reverse recovery current during $t_b$	$di_{rr}/dt$		-	180	-	A/ $\mu\text{s}$

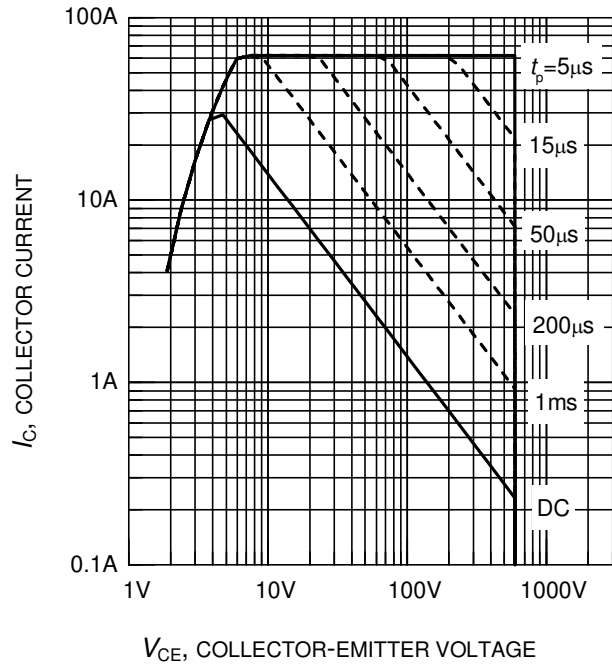
**Switching Characteristic, Inductive Load, at  $T_j=150\text{ }^\circ\text{C}$** 

Parameter	Symbol	Conditions	Value			Unit
			min.	typ.	max.	
<b>IGBT Characteristic</b>						
Turn-on delay time	$t_{d(on)}$	$T_j=150\text{ }^\circ\text{C}$ $V_{CC}=400\text{V}$ , $I_C=15\text{A}$ , $V_{GE}=0/15\text{V}$ , $R_G=21\text{ }\Omega$ , $L_{\sigma}^{1)}$ = 180nH, $C_{\sigma}^{1)}$ = 250pF Energy losses include "tail" and diode reverse recovery.	-	31	38	ns
Rise time	$t_r$		-	23	28	
Turn-off delay time	$t_{d(off)}$		-	261	313	
Fall time	$t_f$		-	54	65	
Turn-on energy	$E_{on}$		-	0.45	0.54	mJ
Turn-off energy	$E_{off}$		-	0.41	0.53	
Total switching energy	$E_{ts}$		-	0.86	1.07	
<b>Anti-Parallel Diode Characteristic</b>						
Diode reverse recovery time	$t_{rr}$	$T_j=150\text{ }^\circ\text{C}$ $V_R=200\text{V}$ , $I_F=15\text{A}$ , $di_F/dt=200\text{A}/\mu\text{s}$	-	360	-	ns
	$t_S$		-	40	-	
	$t_F$		-	320	-	
Diode reverse recovery charge	$Q_{rr}$		-	1020	-	nC
Diode peak reverse recovery current	$I_{rrm}$		-	7.5	-	A
Diode peak rate of fall of reverse recovery current during $t_b$	$di_{rr}/dt$		-	200	-	A/ $\mu\text{s}$

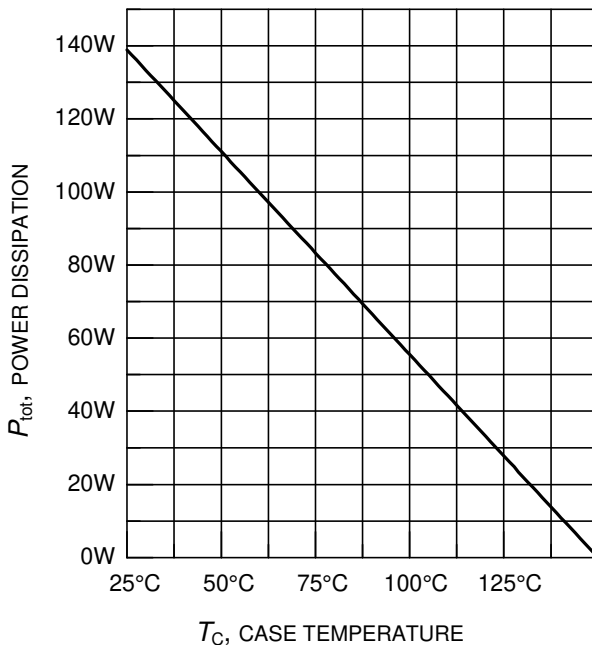
<sup>1)</sup> Leakage inductance  $L_{\sigma}$  and Stray capacity  $C_{\sigma}$  due to dynamic test circuit in Figure E.



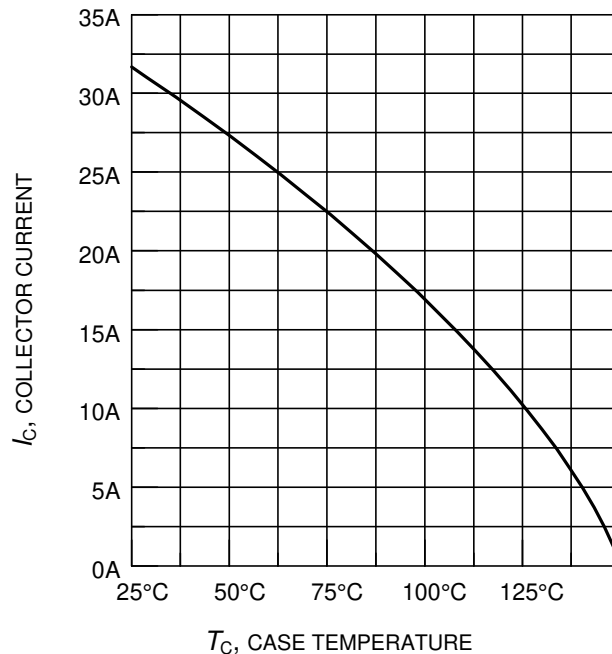
**Figure 1. Collector current as a function of switching frequency**  
 ( $T_j \leq 150^\circ\text{C}$ ,  $D = 0.5$ ,  $V_{CE} = 400\text{V}$ ,  
 $V_{GE} = 0/+15\text{V}$ ,  $R_G = 21\Omega$ )



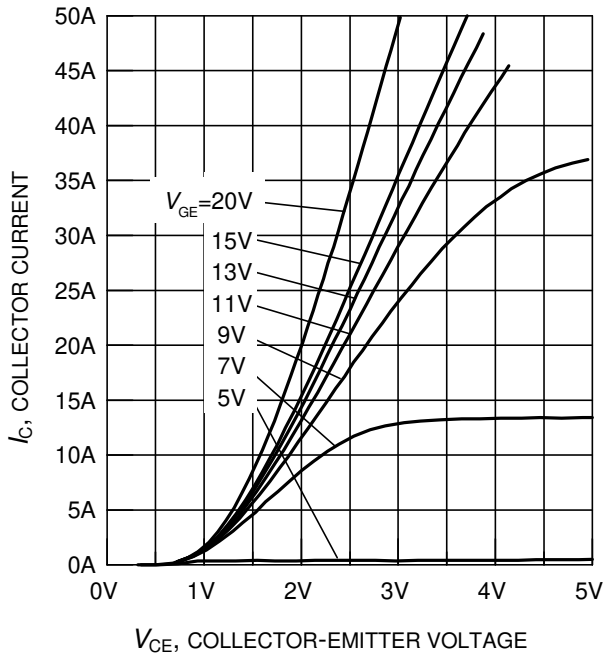
**Figure 2. Safe operating area**  
 ( $D = 0$ ,  $T_C = 25^\circ\text{C}$ ,  $T_j \leq 150^\circ\text{C}$ )



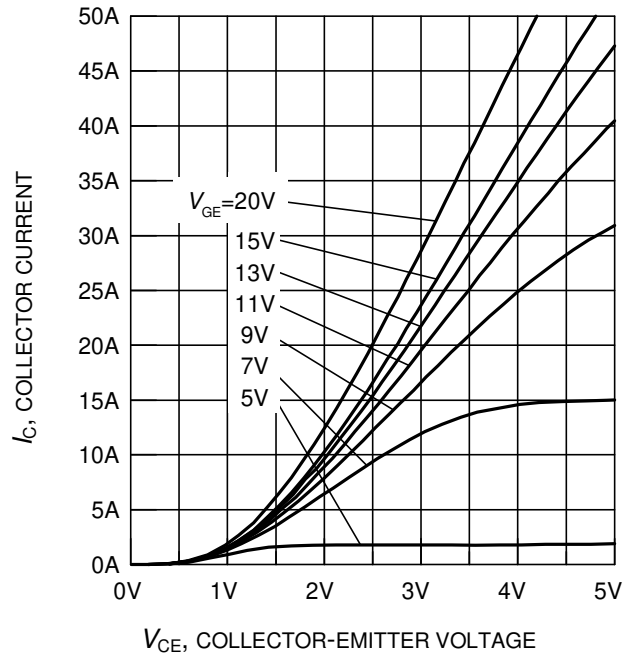
**Figure 3. Power dissipation as a function of case temperature**  
 ( $T_i \leq 150^\circ\text{C}$ )



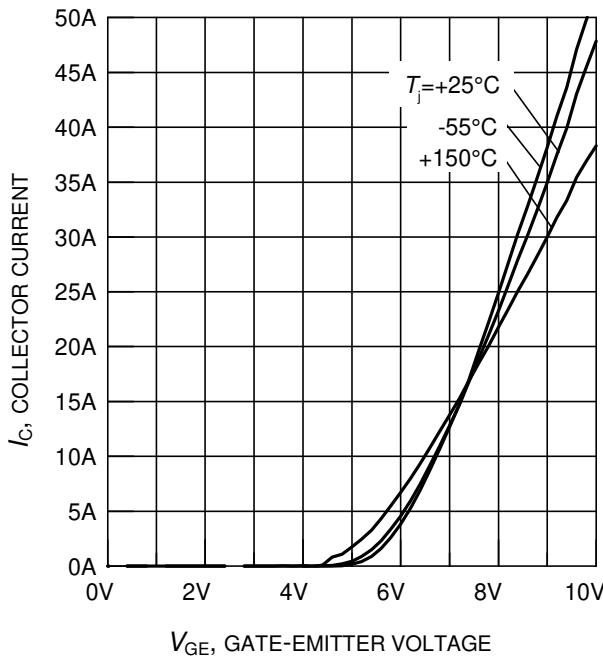
**Figure 4. Collector current as a function of case temperature**  
 ( $V_{GE} \leq 15\text{V}$ ,  $T_i \leq 150^\circ\text{C}$ )



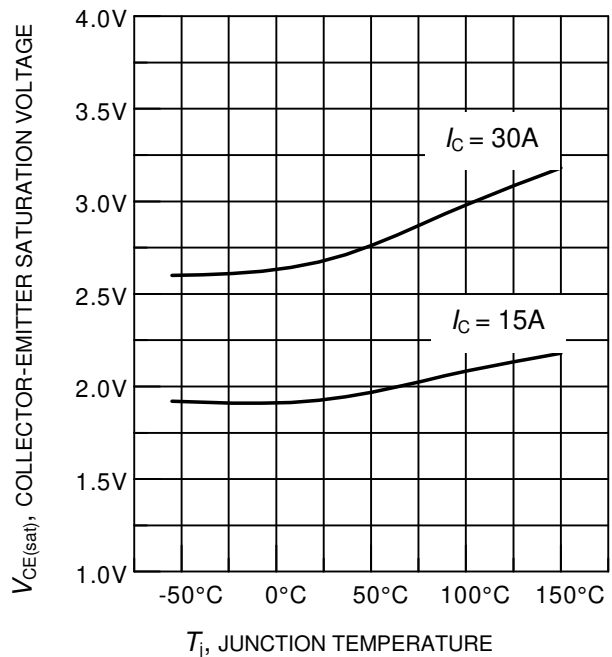
**Figure 5. Typical output characteristics**  
( $T_j = 25^\circ\text{C}$ )



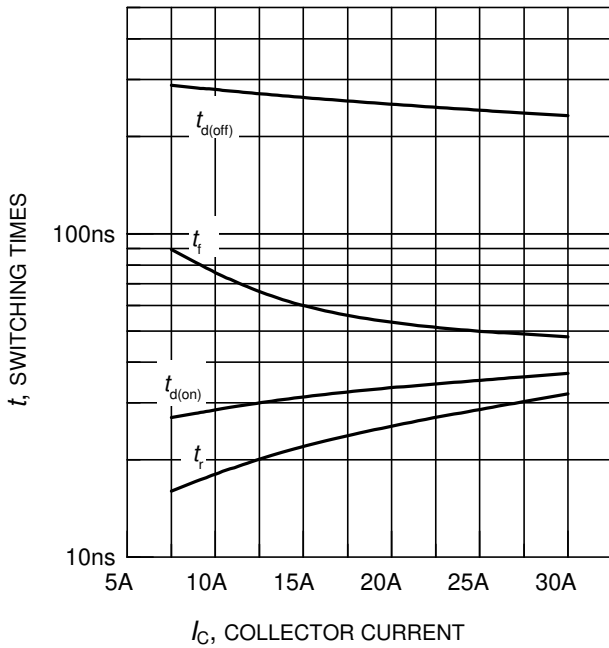
**Figure 6. Typical output characteristics**  
( $T_j = 150^\circ\text{C}$ )



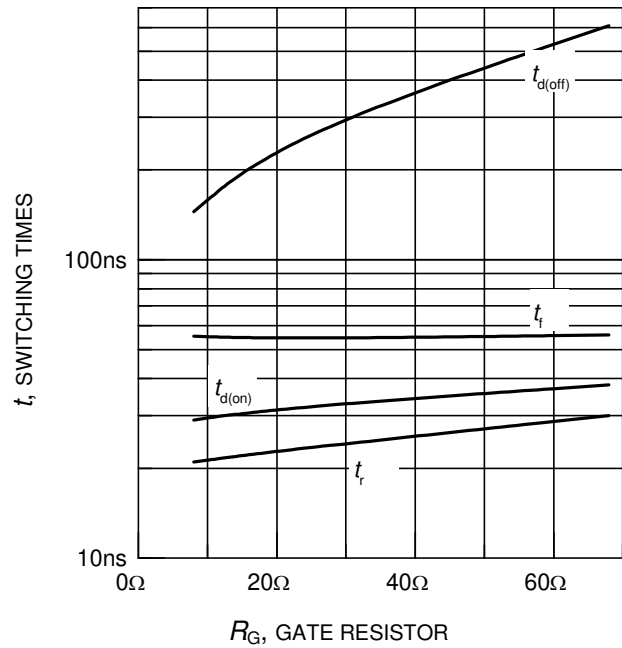
**Figure 7. Typical transfer characteristics**  
( $V_{CE} = 10\text{V}$ )



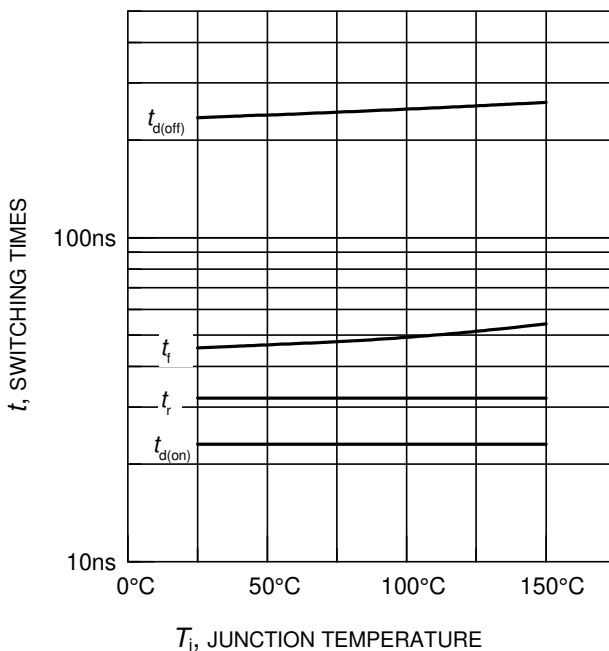
**Figure 8. Typical collector-emitter saturation voltage as a function of junction temperature**  
( $V_{GE} = 15\text{V}$ )



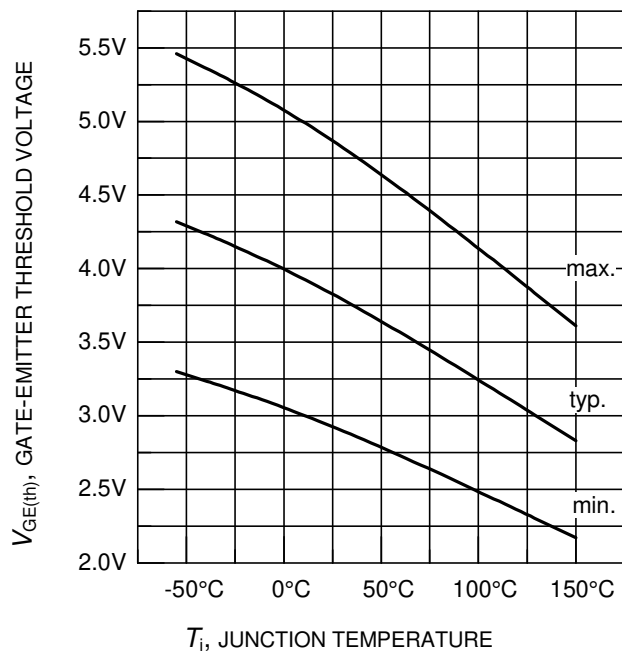
**Figure 9. Typical switching times as a function of collector current**  
 (inductive load,  $T_j = 150^\circ\text{C}$ ,  $V_{CE} = 400\text{V}$ ,  
 $V_{GE} = 0/+15\text{V}$ ,  $R_G = 21\Omega$ ,  
 Dynamic test circuit in Figure E)



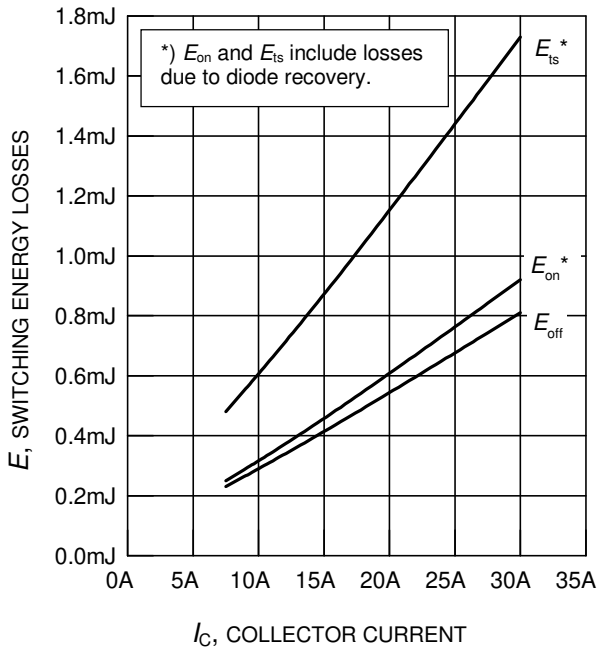
**Figure 10. Typical switching times as a function of gate resistor**  
 (inductive load,  $T_j = 150^\circ\text{C}$ ,  $V_{CE} = 400\text{V}$ ,  
 $V_{GE} = 0/+15\text{V}$ ,  $I_C = 15\text{A}$ ,  
 Dynamic test circuit in Figure E)



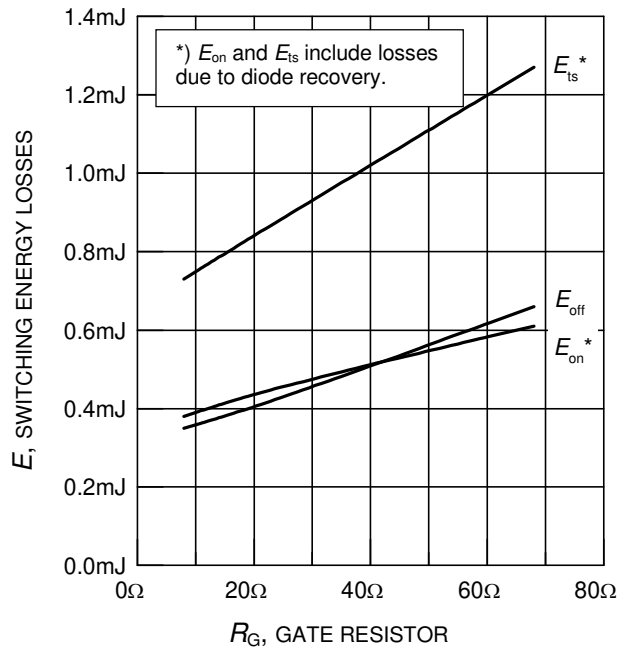
**Figure 11. Typical switching times as a function of junction temperature**  
 (inductive load,  $V_{CE} = 400\text{V}$ ,  $V_{GE} = 0/+15\text{V}$ ,  
 $I_C = 15\text{A}$ ,  $R_G = 21\Omega$ ,  
 Dynamic test circuit in Figure E)



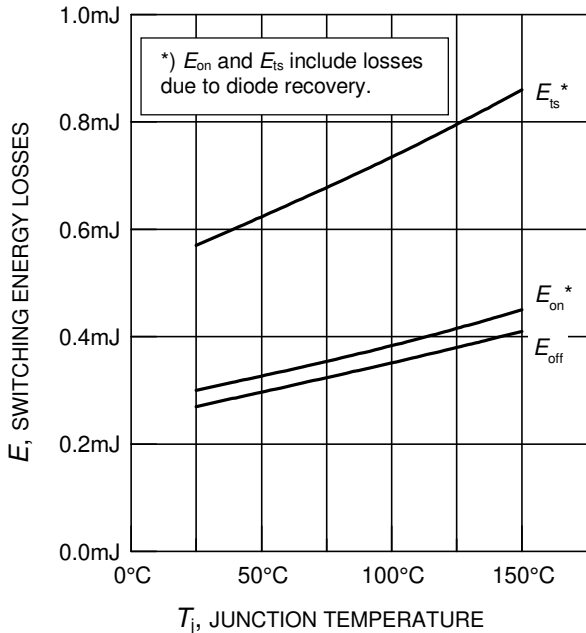
**Figure 12. Gate-emitter threshold voltage as a function of junction temperature**  
 ( $I_C = 0.4\text{mA}$ )



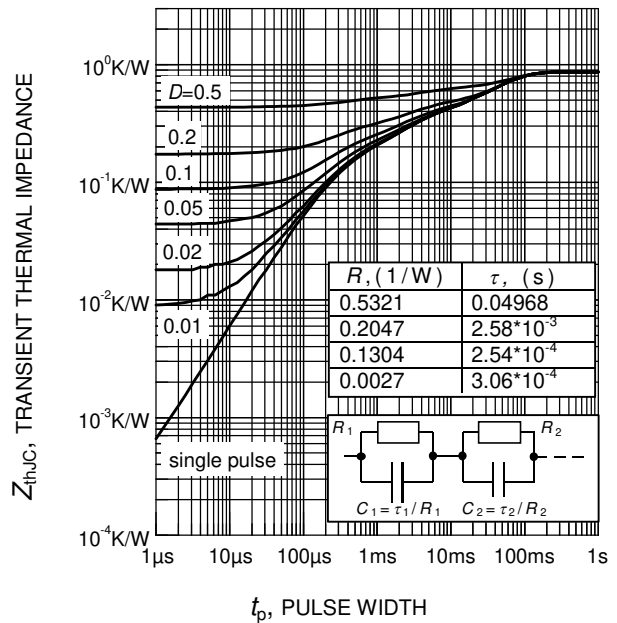
**Figure 13. Typical switching energy losses as a function of collector current**  
 (inductive load,  $T_j = 150^\circ\text{C}$ ,  $V_{CE} = 400\text{V}$ ,  $V_{GE} = 0/+15\text{V}$ ,  $R_G = 21\Omega$ ,  
 Dynamic test circuit in Figure E)



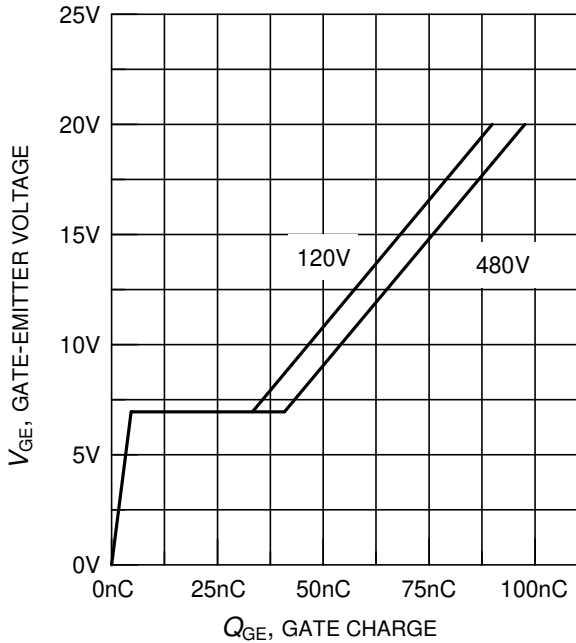
**Figure 14. Typical switching energy losses as a function of gate resistor**  
 (inductive load,  $T_j = 150^\circ\text{C}$ ,  $V_{CE} = 400\text{V}$ ,  $V_{GE} = 0/+15\text{V}$ ,  $I_C = 15\text{A}$ ,  
 Dynamic test circuit in Figure E)



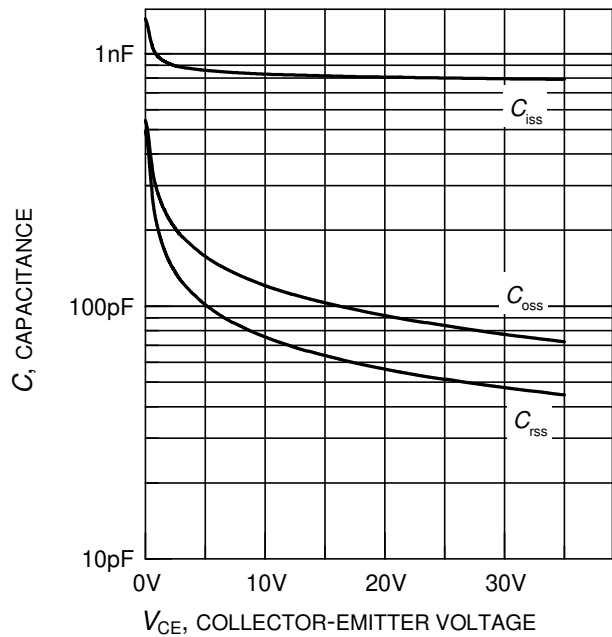
**Figure 15. Typical switching energy losses as a function of junction temperature**  
 (inductive load,  $V_{CE} = 400\text{V}$ ,  $V_{GE} = 0/+15\text{V}$ ,  $I_C = 15\text{A}$ ,  $R_G = 21\Omega$ ,  
 Dynamic test circuit in Figure E)



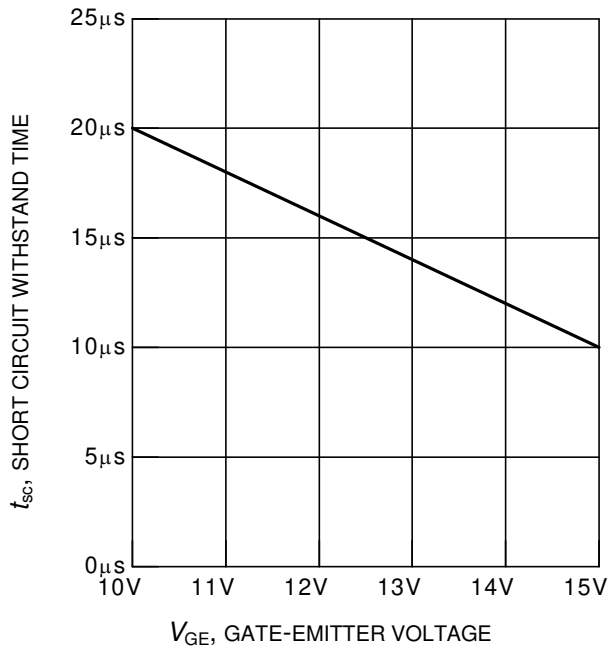
**Figure 16. IGBT transient thermal impedance as a function of pulse width**  
 ( $D = t_p / T$ )



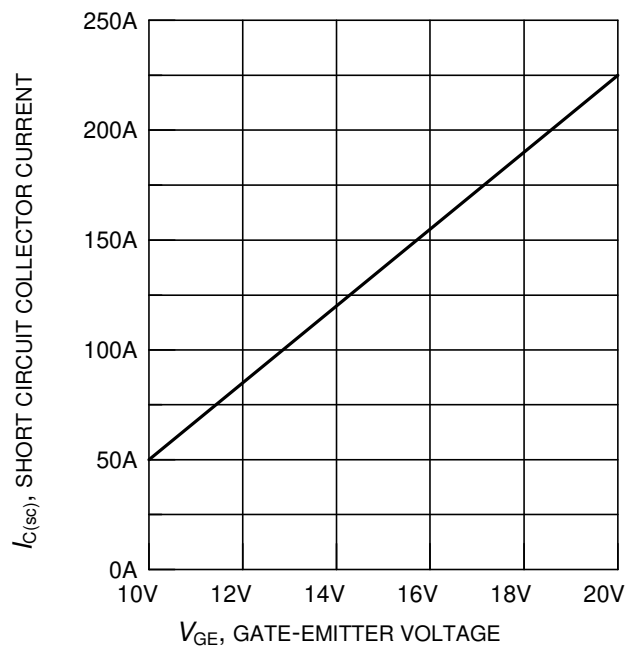
**Figure 17. Typical gate charge**  
( $I_C = 15A$ )



**Figure 18. Typical capacitance as a function of collector-emitter voltage**  
( $V_{GE} = 0V, f = 1MHz$ )

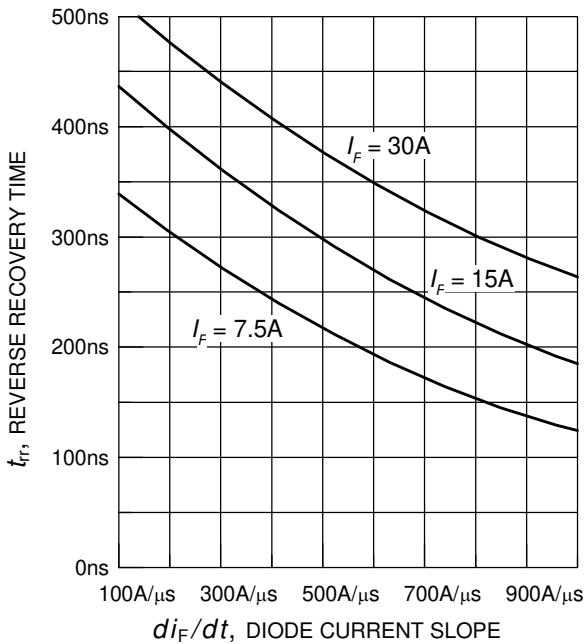


**Figure 19. Short circuit withstand time as a function of gate-emitter voltage**  
( $V_{CE} = 600V, \text{start at } T_j = 25^\circ C$ )

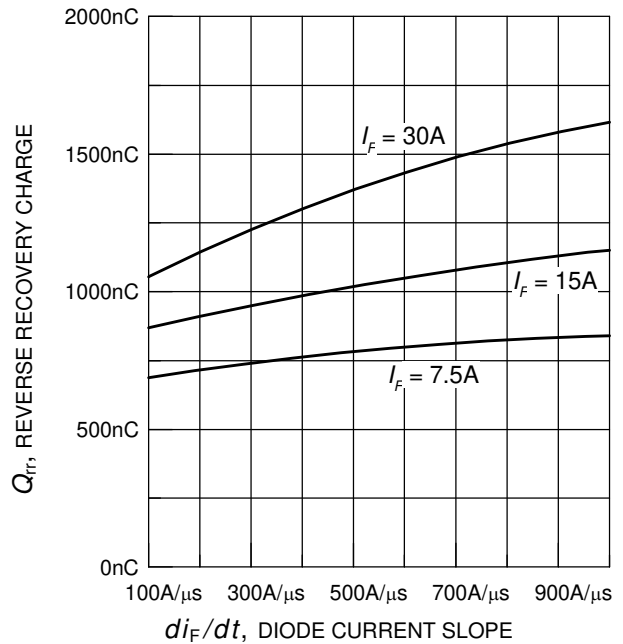


**Figure 20. Typical short circuit collector current as a function of gate-emitter voltage**  
( $V_{CE} \leq 600V, T_j = 150^\circ C$ )

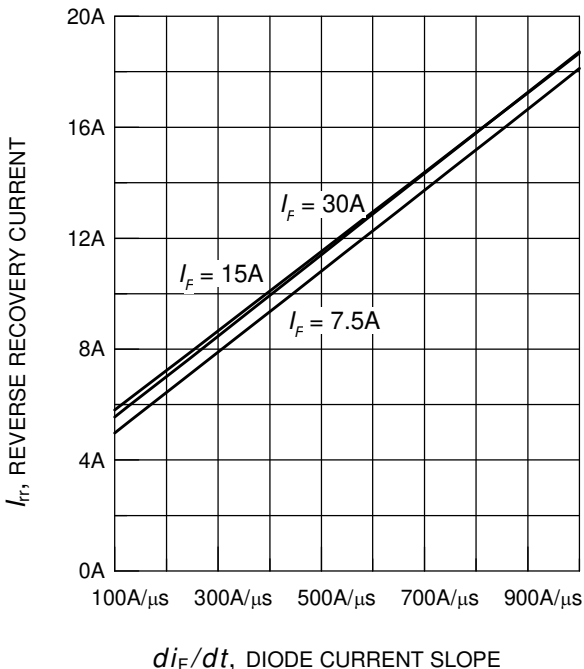




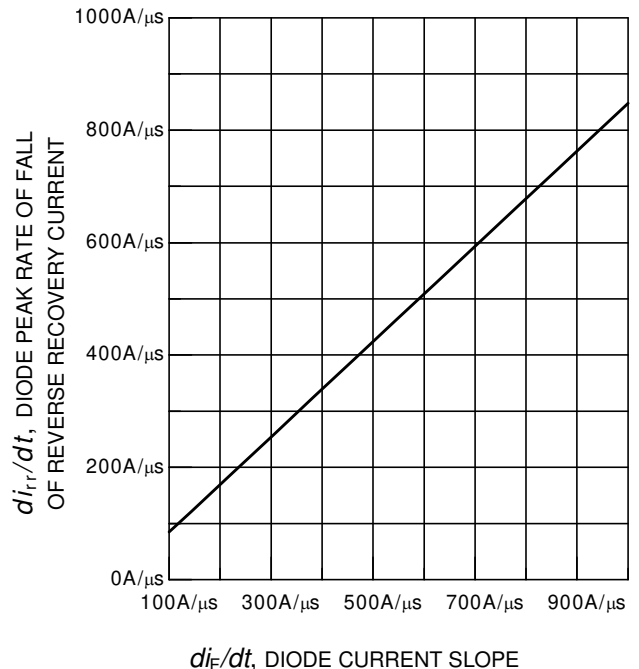
**Figure 21. Typical reverse recovery time as a function of diode current slope**  
 ( $V_R = 200V$ ,  $T_j = 125^\circ C$ ,  
 Dynamic test circuit in Figure E)



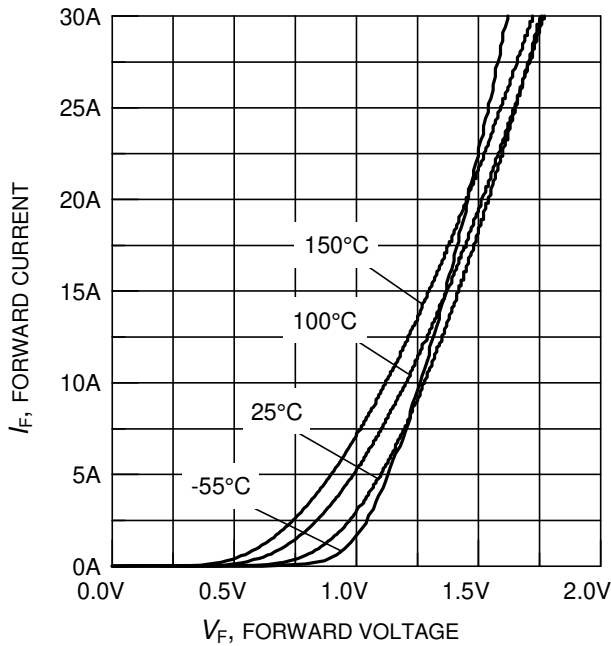
**Figure 22. Typical reverse recovery charge as a function of diode current slope**  
 ( $V_R = 200V$ ,  $T_j = 125^\circ C$ ,  
 Dynamic test circuit in Figure E)



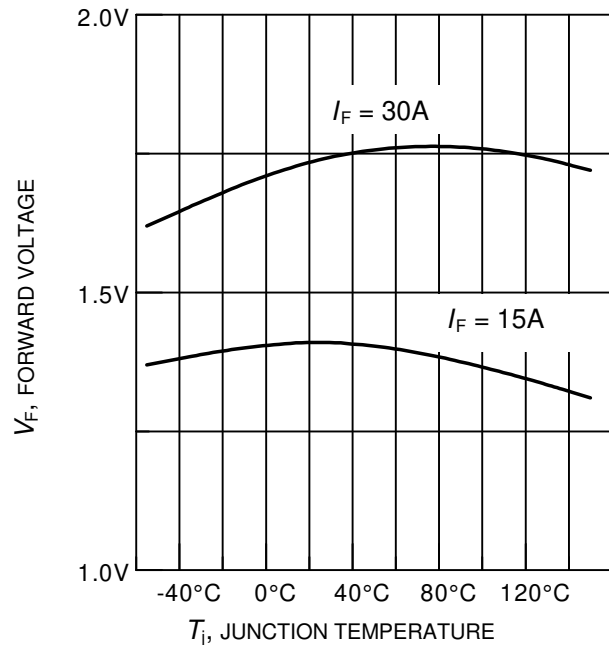
**Figure 23. Typical reverse recovery current as a function of diode current slope**  
 ( $V_R = 200V$ ,  $T_j = 125^\circ C$ ,  
 Dynamic test circuit in Figure E)



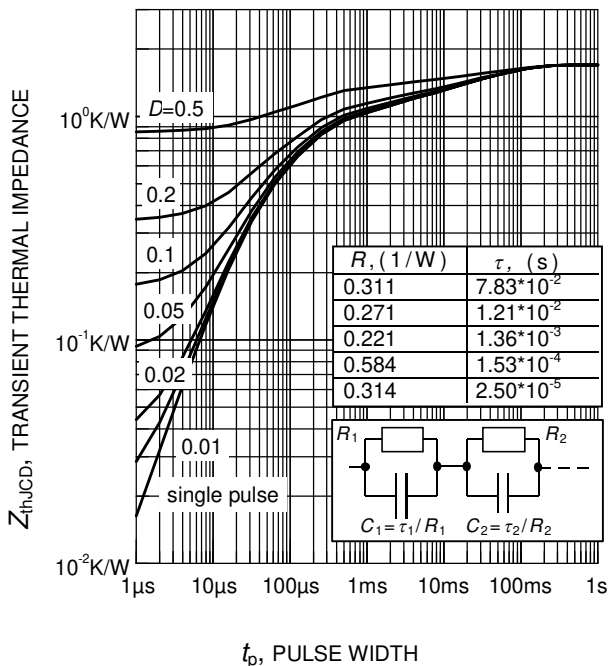
**Figure 24. Typical diode peak rate of fall of reverse recovery current as a function of diode current slope**  
 ( $V_R = 200V$ ,  $T_j = 125^\circ C$ ,  
 Dynamic test circuit in Figure E)



**Figure 25. Typical diode forward current as a function of forward voltage**

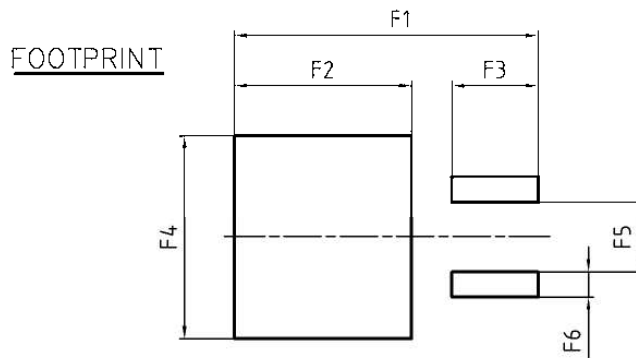
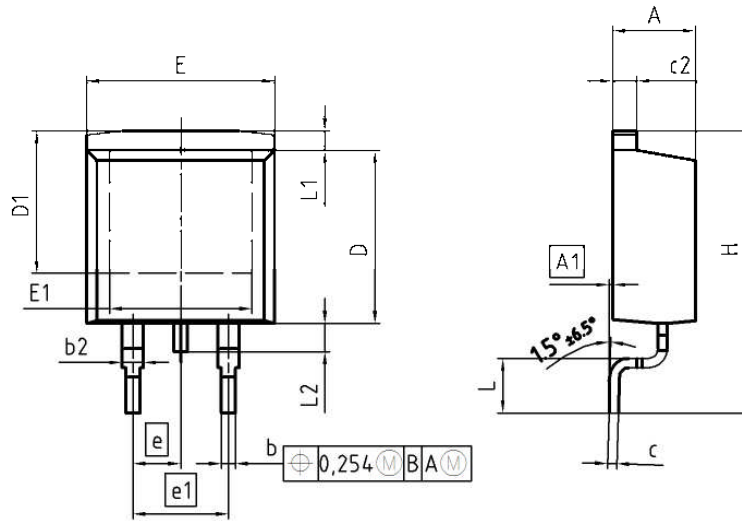


**Figure 26. Typical diode forward voltage as a function of junction temperature**



**Figure 27. Diode transient thermal impedance as a function of pulse width ( $D = t_p / T$ )**

## PG-TO263-3-2



DIM	MILLIMETERS		INCHES	
	MIN	MAX	MIN	MAX
A	4.30	4.57	0.169	0.180
A1	0.00	0.25	0.000	0.010
b	0.65	0.85	0.026	0.033
b2	0.95	1.15	0.037	0.045
c	0.33	0.65	0.013	0.026
c2	1.17	1.40	0.046	0.055
D	8.51	9.45	0.335	0.372
D1	7.10	7.90	0.280	0.311
E	9.80	10.31	0.386	0.406
E1	6.50	8.60	0.256	0.339
e	2.54		0.100	
e1	5.08		0.200	
N	2		2	
H	14.61	15.88	0.575	0.625
L	2.29	3.00	0.090	0.118
L1	0.70	1.60	0.028	0.063
L2	1.00	1.78	0.039	0.070
F1	16.05	16.25	0.632	0.640
F2	9.30	9.50	0.366	0.374
F3	4.50	4.70	0.177	0.185
F4	10.70	10.90	0.421	0.429
F5	3.65	3.85	0.144	0.152
F6	1.25	1.45	0.049	0.057

DOCUMENT NO. Z8B00003324
SCALE 0 5 5 7.5mm
EUROPEAN PROJECTION 
ISSUE DATE 30-08-2007
REVISION 01

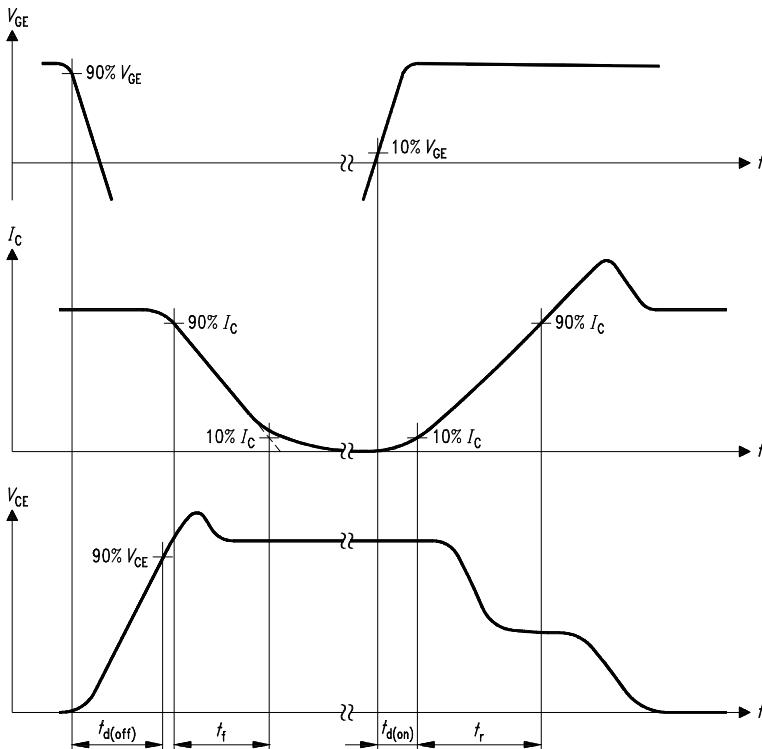


Figure A. Definition of switching times

SIS00053

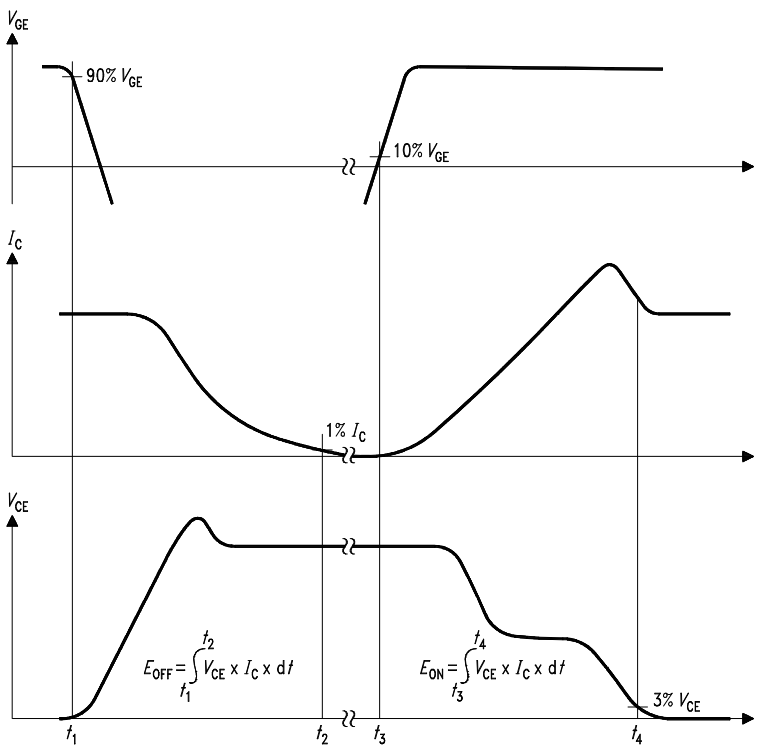


Figure B. Definition of switching losses

SIS00050

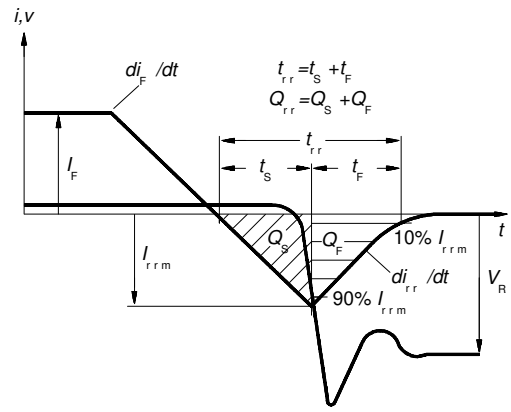


Figure C. Definition of diodes switching characteristics

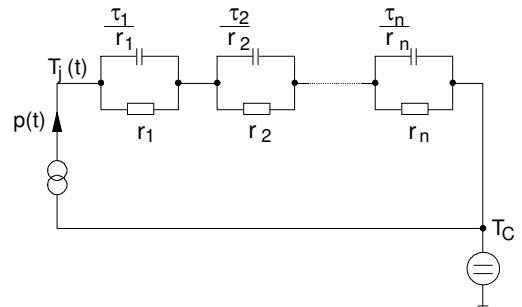


Figure D. Thermal equivalent circuit

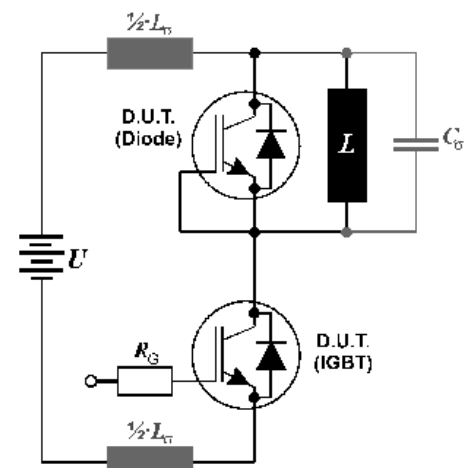


Figure E. Dynamic test circuit  
Leakage inductance  $L_{\sigma} = 180\text{nH}$   
and Stray capacity  $C_{\sigma} = 250\text{pF}$ .

**Published by**  
**Infineon Technologies AG**  
**81726 Munich, Germany**  
**© 2013 Infineon Technologies AG**  
**All Rights Reserved.**

### **Legal Disclaimer**

The information given in this document shall in no event be regarded as a guarantee of conditions or characteristics. With respect to any examples or hints given herein, any typical values stated herein and/or any information regarding the application of the device, Infineon Technologies hereby disclaims any and all warranties and liabilities of any kind, including without limitation, warranties of non-infringement of intellectual property rights of any third party.

### **Information**

For further information on technology, delivery terms and conditions and prices, please contact the nearest Infineon Technologies Office ([www.infineon.com](http://www.infineon.com)).

### **Warnings**

Due to technical requirements, components may contain dangerous substances. For information on the types in question, please contact the nearest Infineon Technologies Office.  
The Infineon Technologies component described in this Data Sheet may be used in life-support devices or systems and/or automotive, aviation and aerospace applications or systems only with the express written approval of Infineon Technologies, if a failure of such components can reasonably be expected to cause the failure of that life-support, automotive, aviation and aerospace device or system or to affect the safety or effectiveness of that device or system. Life support devices or systems are intended to be implanted in the human body or to support and/or maintain and sustain and/or protect human life. If they fail, it is reasonable to assume that the health of the user or other persons may be endangered.