

# GenX3™ 300V IGBT

# IXGH120N30B3\*

\*Obsolete Part Number

$V_{CES} = 300V$   
 $I_{C110} = 120A$   
 $V_{CE(sat)} \leq 1.7V$

Medium speed low  $V_{sat}$  PT IGBTs for 10-50 kHz switching

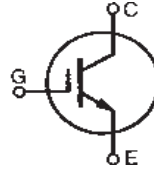

Symbol	Test Conditions	Maximum Ratings	
$V_{CES}$	$T_J = 25^\circ C$ to $150^\circ C$	300	V
$V_{CGR}$	$T_J = 25^\circ C$ to $150^\circ C$ , $R_{GE} = 1M\Omega$	300	V
$V_{GES}$	Continuous	$\pm 20$	V
$V_{GEM}$	Transient	$\pm 30$	V
$I_{C25}$	$T_C = 25^\circ C$ (limited by leads)	75	A
$I_{C110}$	$T_C = 110^\circ C$	120	A
$I_{CM}$	$T_C = 25^\circ C$ , 1ms	480	A
<b>SSOA</b> <b>(RBSOA)</b>	$V_{GE} = 15V$ , $T_J = 125^\circ C$ , $R_G = 1\Omega$ Clamped inductive load @ $V_{CE} \leq 300V$	$I_{CM} = 240$	A
$P_C$	$T_C = 25^\circ C$	540	W
$T_J$		-55 ... +150	$^\circ C$
$T_{JM}$		150	$^\circ C$
$T_{stg}$		-55 ... +150	$^\circ C$
$M_d$	Mounting torque	1.13 / 10	Nm/lb.in.
$T_L$	Maximum lead temperature for soldering	300	$^\circ C$
$T_{SOLD}$	1.6mm (0.062 in.) from case for 10s	260	$^\circ C$
<b>Weight</b>		6	g

TO-247 (IXGH)

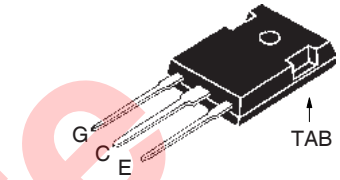

G = Gate      C = Collector  
 E = Emitter    TAB = Collector

### Features

- Optimized for low switching losses
- Square RBSOA
- International standard package

### Advantages

- High power density
- Low gate drive requirement

### Applications

- High Frequency Power Inverters
- UPS
- Motor Drives
- SMPS
- PFC Circuits
- Battery Chargers
- Welding Machines
- Lamp Ballasts

Symbol	Test Conditions ( $T_J = 25^\circ C$ , unless otherwise specified)	Characteristic Values		
		Min.	Typ.	Max.
$BV_{CES}$	$I_C = 250\mu A$ , $V_{GE} = 0V$	300		V
$V_{GE(th)}$	$I_C = 250\mu A$ , $V_{CE} = V_{GE}$	3.0		5.0 V
$I_{CES}$	$V_{CE} = V_{CES}$ $V_{GE} = 0V$ $T_J = 125^\circ C$			10 $\mu A$ 500 $\mu A$
$I_{GES}$	$V_{CE} = 0V$ , $V_{GE} = \pm 20V$			$\pm 100$ nA
$V_{CE(sat)}$	$I_C = 120A$ , $V_{GE} = 15V$ , Note 1 $T_J = 125^\circ C$	1.42	1.70	V
		1.47		V

Symbol	Test Conditions ( $T_J = 25^\circ\text{C}$ , unless otherwise specified)	Characteristic Values		
		Min.	Typ.	Max.
$g_{fs}$	$I_C = 60\text{A}, V_{CE} = 10\text{V}$ , Note 1	55	90	S
$C_{ies}$ $C_{oes}$ $C_{res}$	$V_{CE} = 25\text{V}, V_{GE} = 0\text{V}, f = 1\text{MHz}$		6700	pF
			650	pF
			160	pF
$Q_g$ $Q_{ge}$ $Q_{gc}$	$I_C = 120\text{A}, V_{GE} = 15\text{V}, V_{CE} = 0.5 \cdot V_{CES}$		225	nC
			38	nC
			85	nC
$t_{d(on)}$ $t_r$ $t_{d(off)}$ $t_f$	<b>Resistive load, <math>T_J = 25^\circ\text{C}</math></b> $I_C = 60\text{A}, V_{GE} = 15\text{V}$ $V_{CE} = 240\text{V}, R_G = 1\Omega$		22	ns
			27	ns
			100	ns
			64	ns
$t_{d(on)}$ $t_r$ $t_{d(off)}$ $t_f$	<b>Resistive load, <math>T_J = 125^\circ\text{C}</math></b> $I_C = 60\text{A}, V_{GE} = 15\text{V}$ $V_{CE} = 240\text{V}, R_G = 1\Omega$		21	ns
			30	ns
			106	ns
			250	ns
$R_{thJC}$ $R_{thCK}$			0.21	$0.23^\circ\text{C/W}$ $^\circ\text{C/W}$

TO-247 (IXGH) Outline

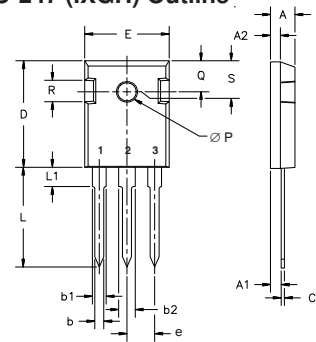

Terminals: 1 - Gate      2 - Drain  
                                 3 - Source      Tab - Drain

Dim.	Millimeter		Inches	
	Min.	Max.	Min.	Max.
A	4.7	5.3	.185	.209
A <sub>1</sub>	2.2	2.54	.087	.102
A <sub>2</sub>	2.2	2.6	.059	.098
b	1.0	1.4	.040	.055
b <sub>1</sub>	1.65	2.13	.065	.084
b <sub>2</sub>	2.87	3.12	.113	.123
C	.4	.8	.016	.031
D	20.80	21.46	.819	.845
E	15.75	16.26	.610	.640
e	5.20	5.72	0.205	0.225
L	19.81	20.32	.780	.800
L1		4.50		.177
ØP	3.55	3.65	.140	.144
Q	5.89	6.40	0.232	0.252
R	4.32	5.49	.170	.216
S	6.15	BSC	242	BSC

Notes: 1. Pulse test,  $t \leq 300\mu\text{s}$ ; duty cycle,  $d \leq 2\%$ .

IXYS reserves the right to change limits, test conditions, and dimensions.

IXYS MOSFETs and IGBTs are covered by one or more of the following U.S. patents:

4,835,592	4,931,844	5,049,961	5,237,481	6,162,665	6,404,065 B1	6,683,344	6,727,585	7,005,734 B2	7,157,338B2
4,850,072	5,017,508	5,063,307	5,381,025	6,259,123 B1	6,534,343	6,710,405 B2	6,759,692	7,063,975 B2	
4,881,106	5,034,796	5,187,117	5,486,715	6,306,728 B1	6,583,505	6,710,463	6,771,478 B2	7,071,537	

**Fig. 1. Output Characteristics @ 25°C**

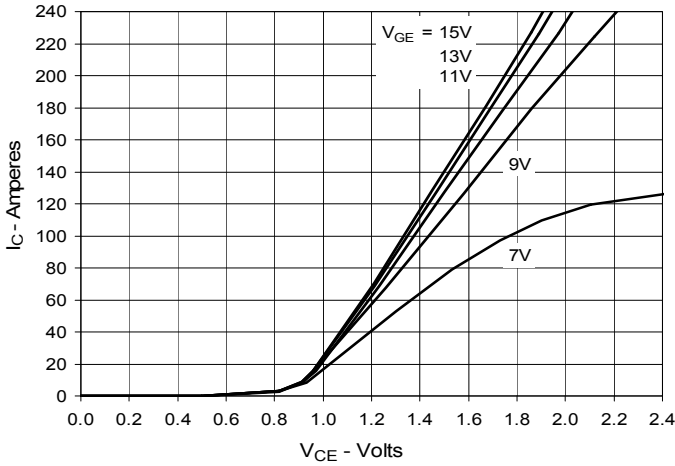

**Fig. 2. Extended Output Characteristics @ 25°C**

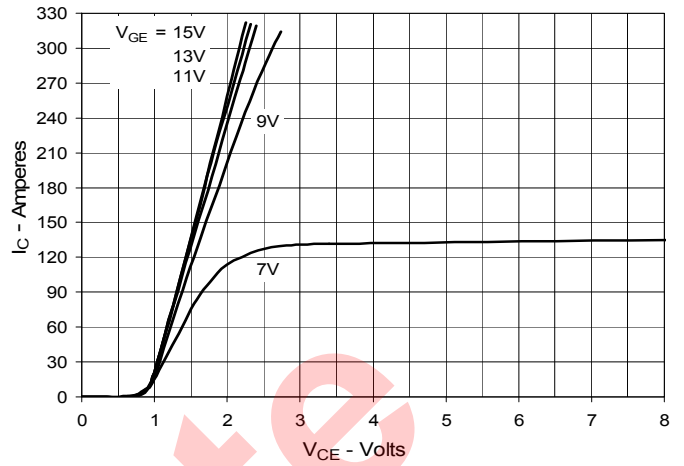

**Fig. 3. Output Characteristics @ 125°C**

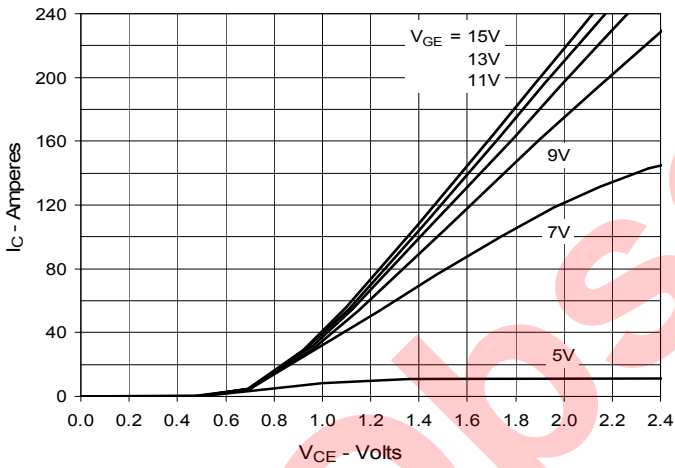

**Fig. 4. Dependence of  $V_{CE(sat)}$  on Junction Temperature**

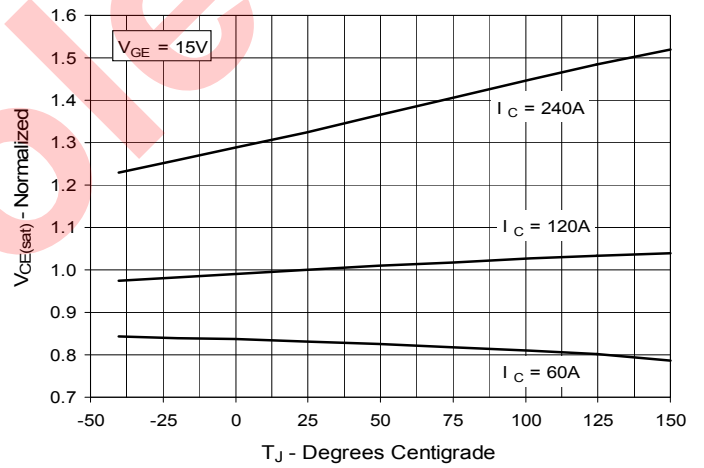

**Fig. 5. Collector-to-Emitter Voltage vs. Gate-to-Emitter Voltage**

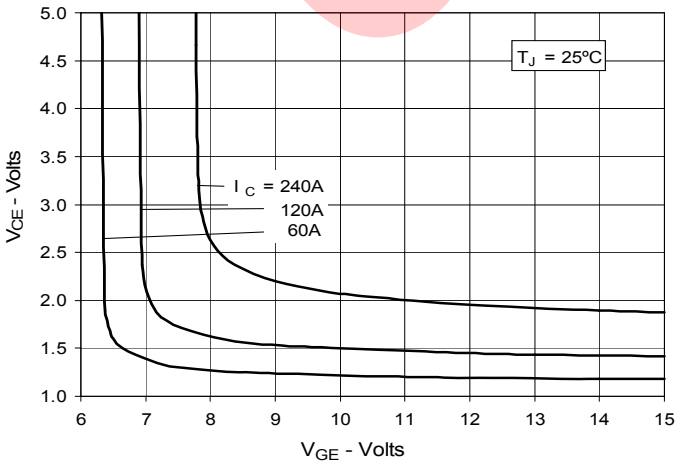

**Fig. 6. Input Admittance**

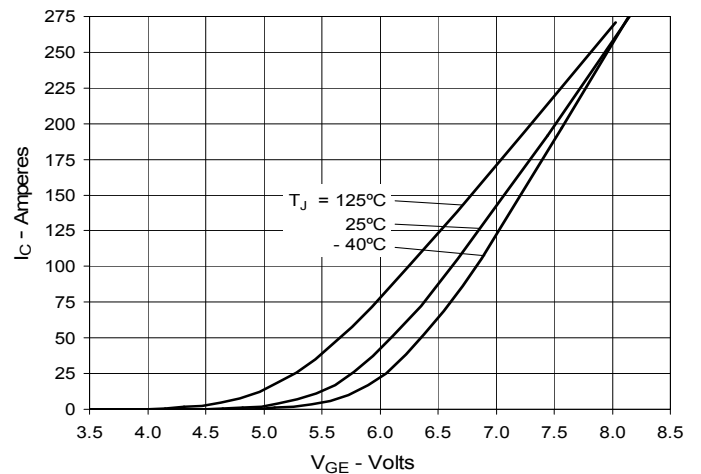

**Fig. 7. Transconductance**

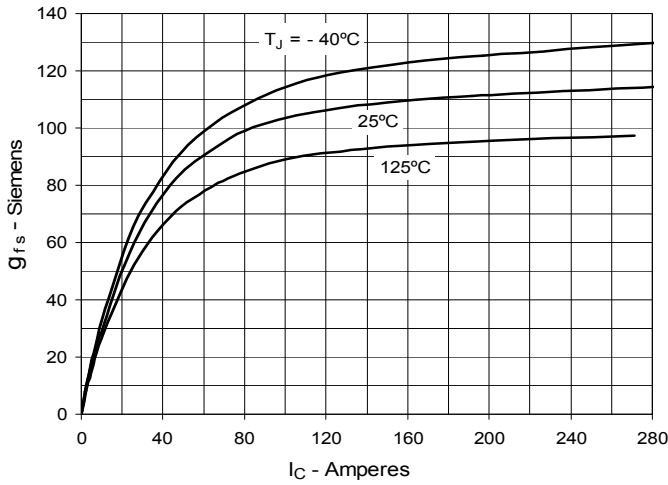

**Fig. 8. Gate Charge**

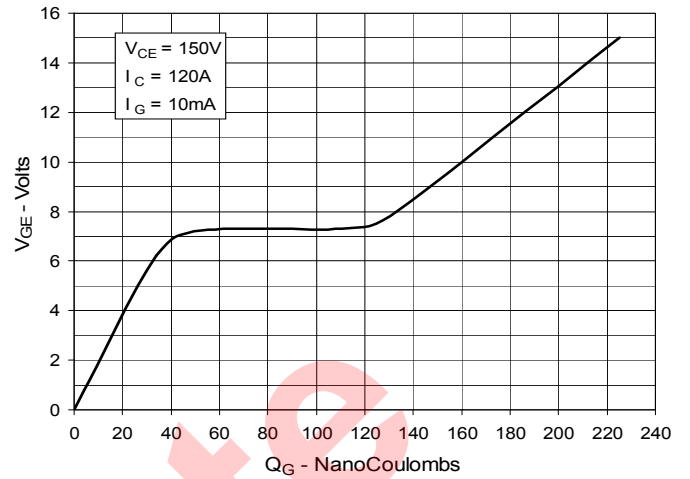

**Fig. 9. Reverse-Bias Safe Operating Area**

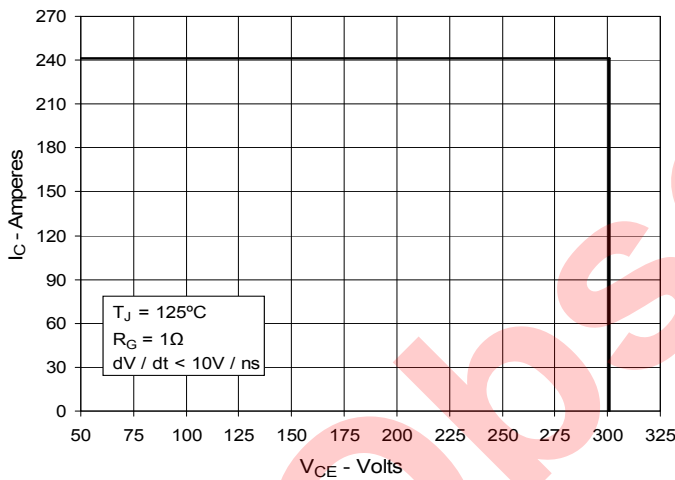

**Fig. 10. Capacitance**

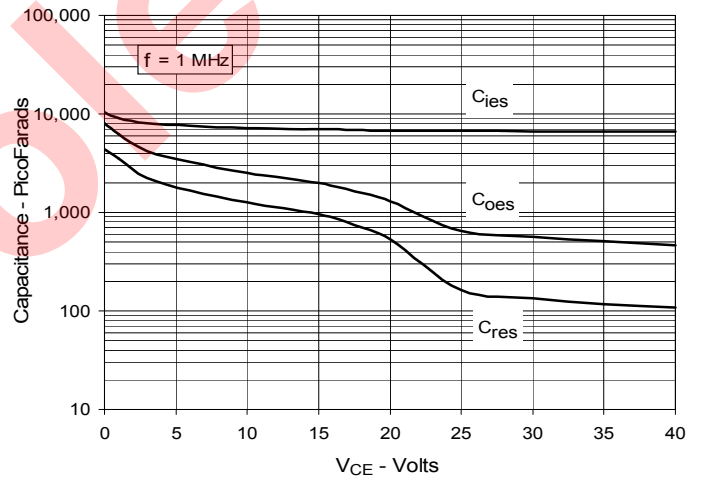

**Fig. 11. Maximum Transient Thermal Impedance**

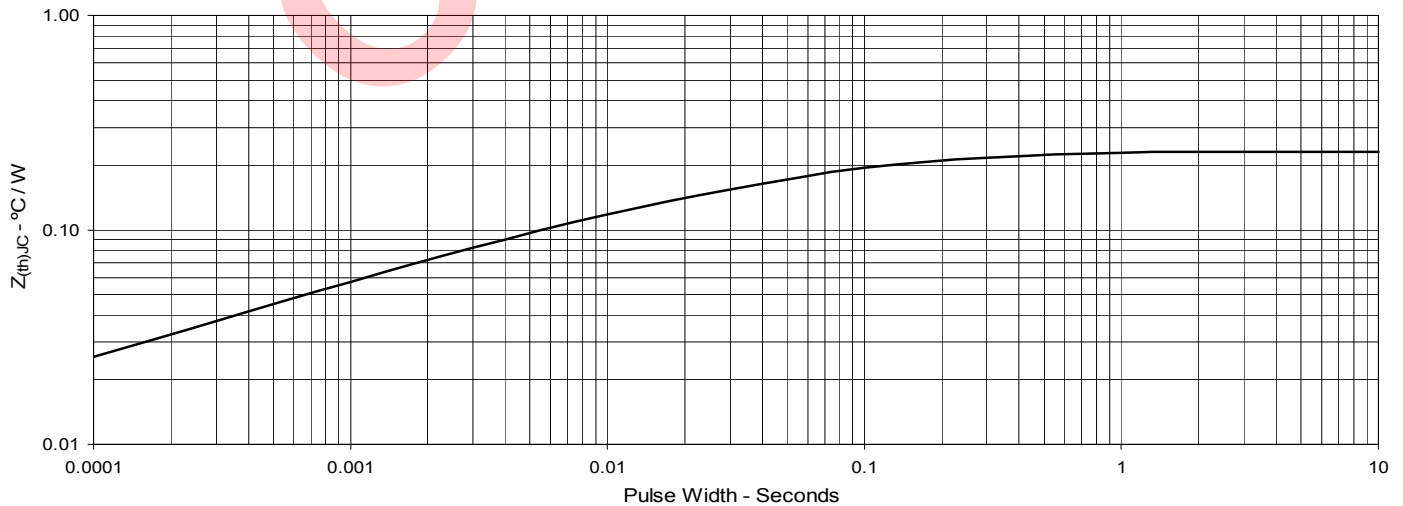

IXYS reserves the right to change limits, test conditions, and dimensions.

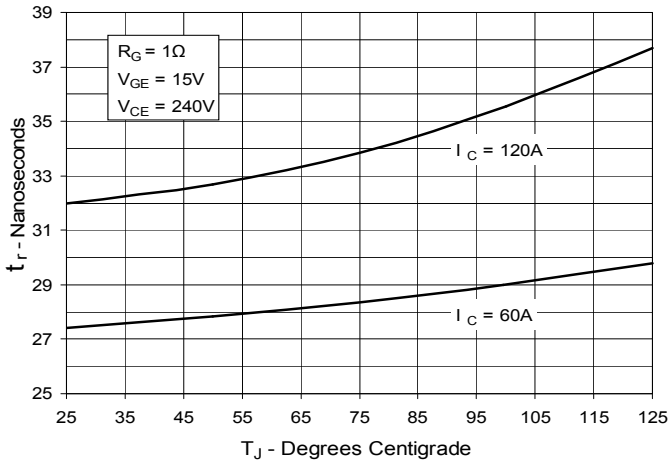
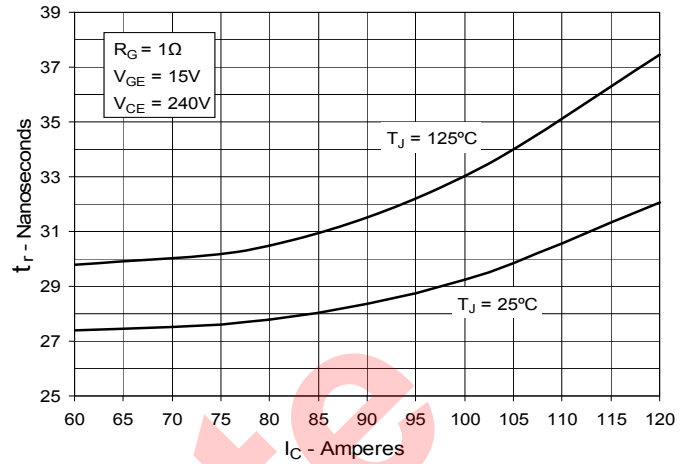
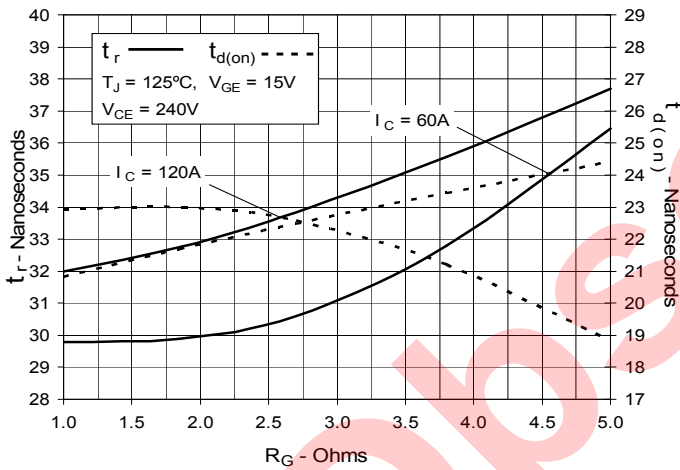
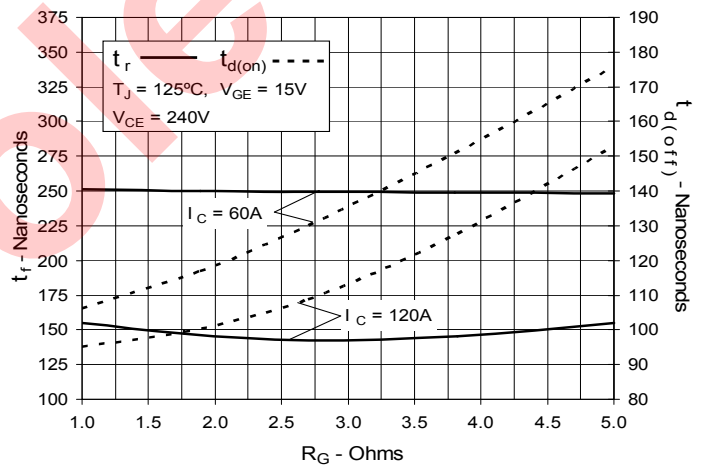
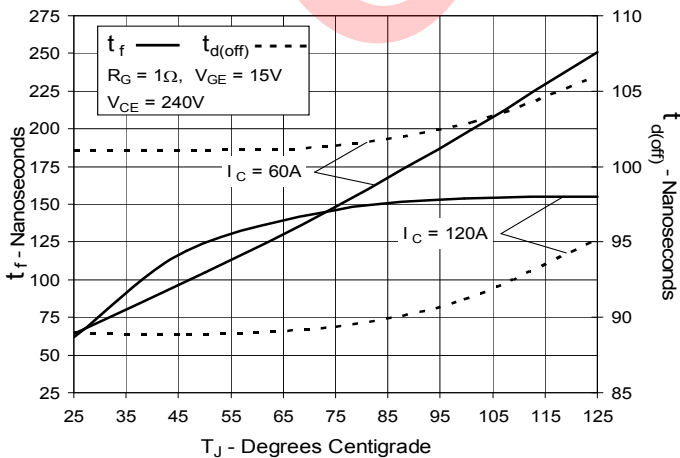
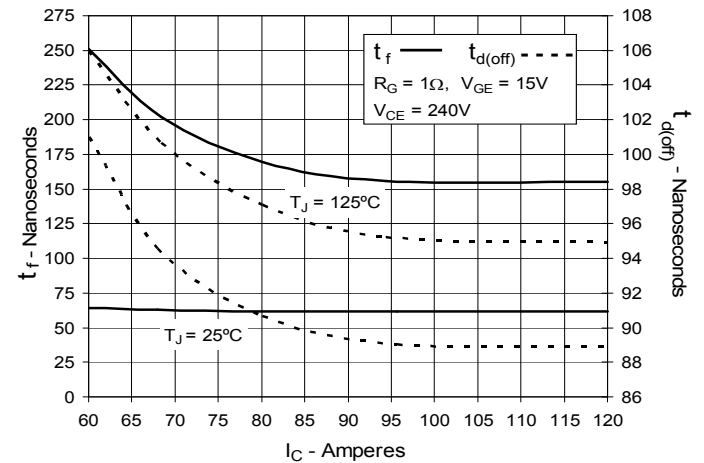
**Fig. 12. Resistive Turn-on Rise Time vs. Junction Temperature**

**Fig. 13. Resistive Turn-on Rise Time vs. Collector Current**

**Fig. 14. Resistive Turn-on Switching Times vs. Gate Resistance**

**Fig. 15. Resistive Turn-off Switching Times vs. Gate Resistance**

**Fig. 16. Resistive Turn-off Switching Times vs. Junction Temperature**

**Fig. 17. Resistive Turn-off Switching Times vs. Collector Current**

Obsolete



**IXYS**  
A Littelfuse Technology

---

Disclaimer Notice - Information furnished is believed to be accurate and reliable. However, users should independently evaluate the suitability of and test each product selected for their own applications. Littelfuse products are not designed for, and may not be used in, all applications. Read complete Disclaimer Notice at [www.littelfuse.com/disclaimer-electronics](http://www.littelfuse.com/disclaimer-electronics).