

**1200V XPT™
GenX4™ IGBT**

**IXYA20N120B4HV
IXYP20N120B4**

V_{CES} = 1200V
I_{C110} = 20A
V_{CE(sat)} ≤ 2.1V
t_{fi(typ)} = 90ns

Extreme Light Punch Through
IGBT for up to 5 - 30kHz Switching

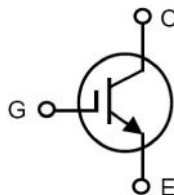

| Symbol | Test Conditions | Maximum Ratings | |
|-------------------------------|--|--|----------|
| V _{CES} | T _J = 25°C to 175°C | 1200 | V |
| V _{CGR} | T _J = 25°C to 175°C, R _{GE} = 1MΩ | 1200 | V |
| V _{GES} | Continuous | ±20 | V |
| V _{GEM} | Transient | ±30 | V |
| I _{C25} | T _C = 25°C | 76 | A |
| I _{C110} | T _C = 110°C | 20 | A |
| I _{CM} | T _C = 25°C, 1ms | 130 | A |
| SSOA (RBSOA) | V _{GE} = 15V, T _{VJ} = 150°C, R _G = 10Ω Clamped Inductive Load | I _{CM} = 40 V _{CE} ≤ 0.8 • V _{CES} | A |
| P _C | T _C = 25°C | 375 | W |
| T _J | | -55 ... +175 | °C |
| T _{JM} | | 175 | °C |
| T _{stg} | | -55 ... +175 | °C |
| T _L | Maximum Lead Temperature for Soldering | 300 | °C |
| T _{SOLD} | 1.6 mm (0.062in.) from Case for 10s | 260 | °C |
| M _d | Mounting Torque (TO-220) | 1.13/10 | Nm/lb.in |
| F _C | Mounting Force (TO-263HV) | 10..65 / 22..14.6 | N/lb |
| Weight | TO-263HV | 2.5 | g |
| | TO-220 | 3.0 | g |

**TO-263HV
(IXYA..HV)**

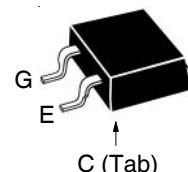

**TO-220
(IXYP)**

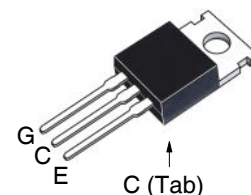

G = Gate D = Collector
E = Emitter Tab = Collector

Features

- Optimized for 5-30kHz Switching
- Positive Thermal Coefficient of V_{ce(sat)}
- International Standard Packages

Advantages

- High Power Density
- Low Gate Drive Requirement

Applications

- Power Inverters
- UPS
- Motor Drives
- SMPS
- Battery Chargers
- Welding Machines
- Lamp Ballasts

| Symbol | Test Conditions (T _J = 25°C, Unless Otherwise Specified) | Characteristic Values | | |
|----------------------------|---|-----------------------|------|---------------|
| | | Min. | Typ. | Max. |
| BV_{CES} | I _C = 250μA, V _{GE} = 0V | 1200 | | V |
| V_{GE(th)} | I _C = 250μA, V _{CE} = V _{GE} | 4.0 | | 6.5 V |
| I_{CES} | V _{CE} = V _{CES} , V _{GE} = 0V T _J = 150°C | | | 25 μA 5 mA |
| I_{GES} | V _{CE} = 0V, V _{GE} = ±20V | | | ±100 nA |
| V_{CE(sat)} | I _C = 20A, V _{GE} = 15V, Note 1 T _J = 150°C | 1.83 2.18 | | V V |

| Symbol Test Conditions ($T_J = 25^\circ\text{C}$ Unless Otherwise Specified) | | Characteristic Values | | |
|--|--|-----------------------|------|-------------------------|
| | | Min. | Typ. | Max. |
| g_{fs} | $I_C = 20\text{A}, V_{CE} = 10\text{V}$, Note 1 | 7.5 | 12.5 | S |
| C_{ies} | $V_{CE} = 25\text{V}, V_{GE} = 0\text{V}, f = 1\text{MHz}$ | | 890 | pF |
| C_{oes} | | | 58 | pF |
| C_{res} | | | 33 | pF |
| $Q_{g(on)}$ | $I_C = 20\text{A}, V_{GE} = 15\text{V}, V_{CE} = 0.5 \cdot V_{CES}$ | | 44 | nC |
| Q_{ge} | | | 8 | nC |
| Q_{gc} | | | 20 | nC |
| $t_{d(on)}$ | Inductive load, $T_J = 25^\circ\text{C}$ $I_C = 20\text{A}, V_{GE} = 15\text{V}$ $V_{CE} = 0.8 \cdot V_{CES}, R_G = 10\Omega$ Note 2 | | 15 | ns |
| t_{ri} | | | 47 | ns |
| E_{on} | | | 3.9 | mJ |
| $t_{d(off)}$ | | | 200 | ns |
| t_{fi} | | | 90 | ns |
| E_{off} | | | 1.6 | mJ |
| $t_{d(on)}$ | Inductive load, $T_J = 125^\circ\text{C}$ $I_C = 20\text{A}, V_{GE} = 15\text{V}$ $V_{CE} = 0.8 \cdot V_{CES}, R_G = 10\Omega$ Note 2 | | 13 | ns |
| t_{ri} | | | 35 | ns |
| E_{on} | | | 4.6 | mJ |
| $t_{d(off)}$ | | | 270 | ns |
| t_{fi} | | | 170 | ns |
| E_{off} | | | 2.7 | mJ |
| R_{thJC} | TO-220 | | | 0.40 $^\circ\text{C/W}$ |
| R_{thCS} | | 0.50 | | $^\circ\text{C/W}$ |

Notes:

1. Pulse test, $t \leq 300\mu\text{s}$, duty cycle, $d \leq 2\%$.
2. Switching times & energy losses may increase for higher V_{CE} (clamp), T_J or R_G .

IXYS Reserves the Right to Change Limits, Test Conditions, and Dimensions.

IXYS MOSFETs and IGBTs are covered by one or more of the following U.S. patents:

| | | | | | | | | | |
|-----------|-----------|-----------|-----------|--------------|--------------|--------------|--------------|--------------|-------------|
| 4,835,592 | 4,931,844 | 5,049,961 | 5,237,481 | 6,162,665 | 6,404,065 B1 | 6,683,344 | 6,727,585 | 7,005,734 B2 | 7,157,338B2 |
| 4,860,072 | 5,017,508 | 5,063,307 | 5,381,025 | 6,259,123 B1 | 6,534,343 | 6,710,405 B2 | 6,759,692 | 7,063,975 B2 | |
| 4,881,106 | 5,034,796 | 5,187,117 | 5,486,715 | 6,306,728 B1 | 6,583,505 | 6,710,463 | 6,771,478 B2 | 7,071,537 | |

Fig. 1. Output Characteristics @ $T_J = 25^\circ\text{C}$

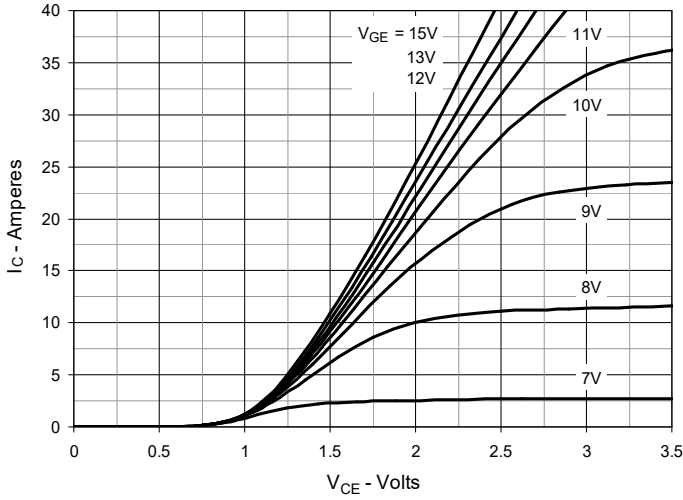

Fig. 2. Extended Output Characteristics @ $T_J = 25^\circ\text{C}$

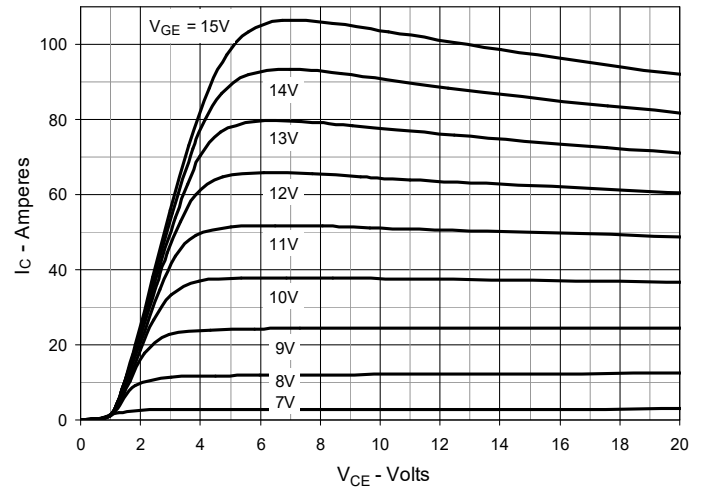

Fig. 3. Output Characteristics @ $T_J = 150^\circ\text{C}$

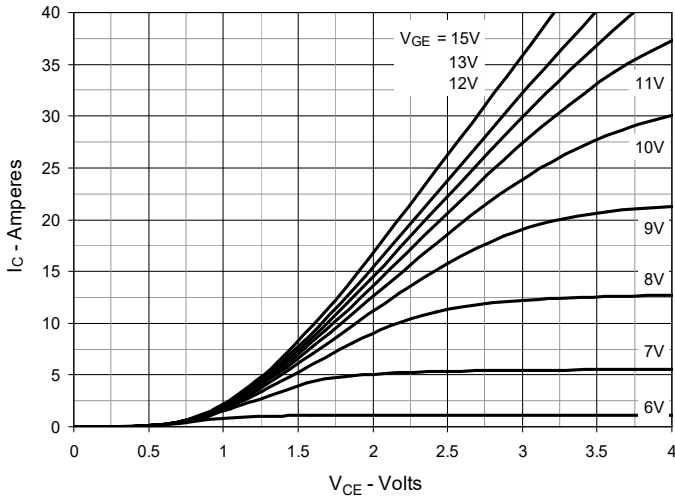

Fig. 4. Dependence of $V_{CE(sat)}$ on Junction Temperature

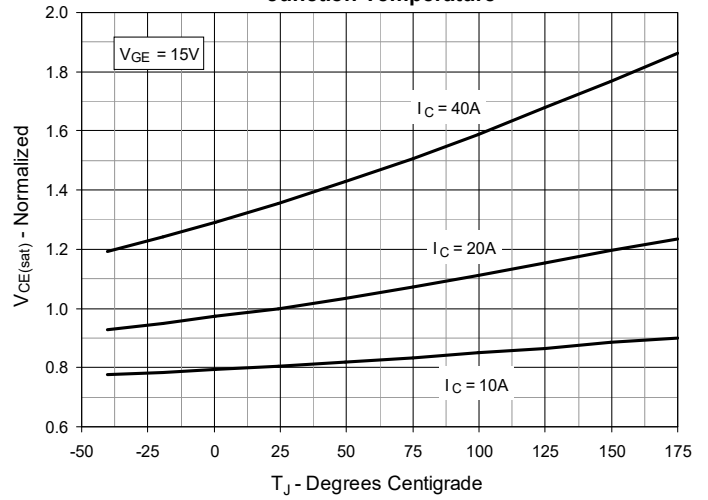

Fig. 5. Collector-to-Emitter Voltage vs. Gate-to-Emitter Voltage

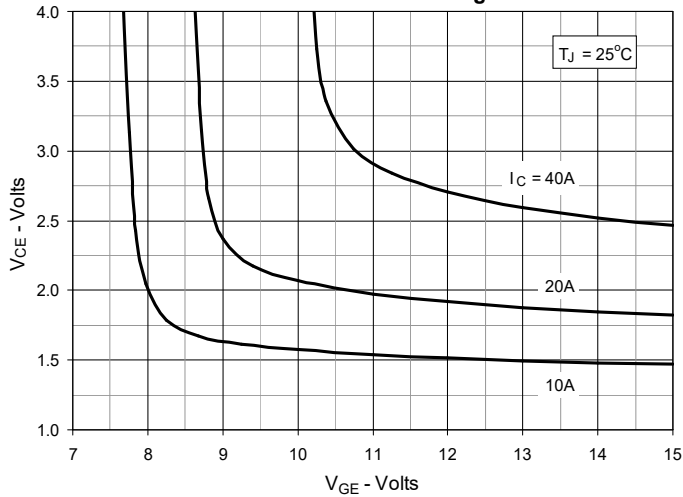

Fig. 6. Input Admittance

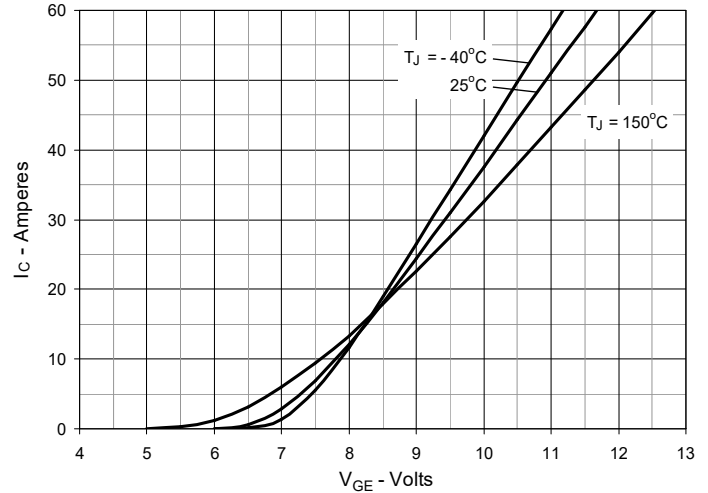

Fig. 7. Transconductance

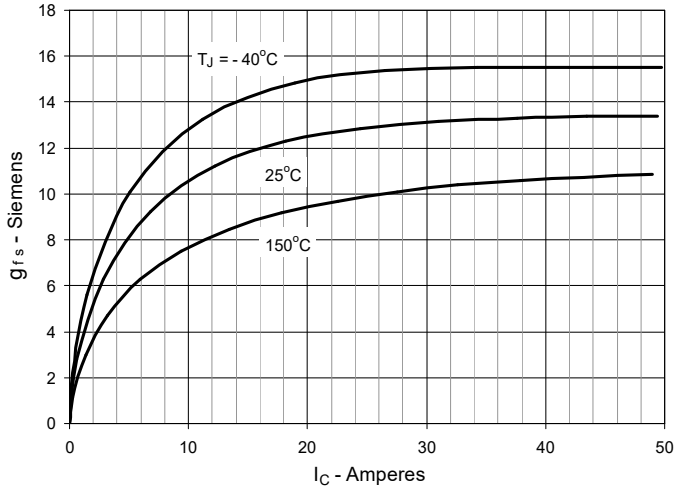

Fig. 8. Gate Charge

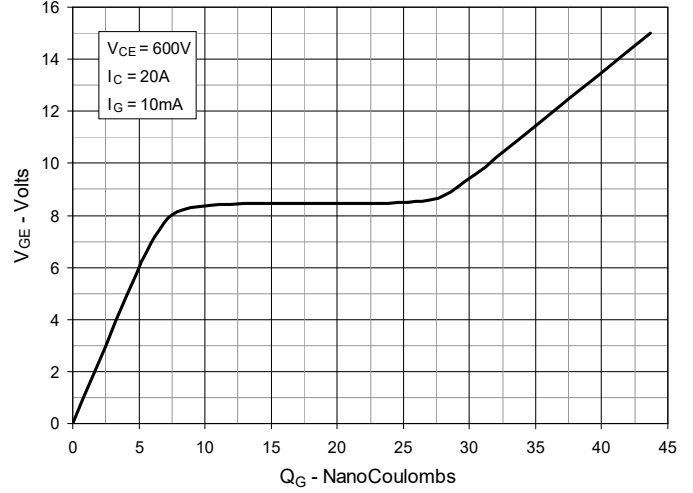

Fig. 9. Capacitance

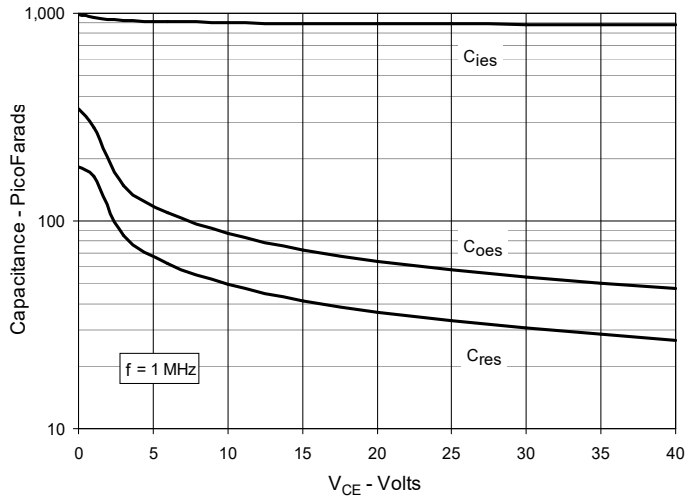

Fig. 10. Reverse-Bias Safe Operating Area

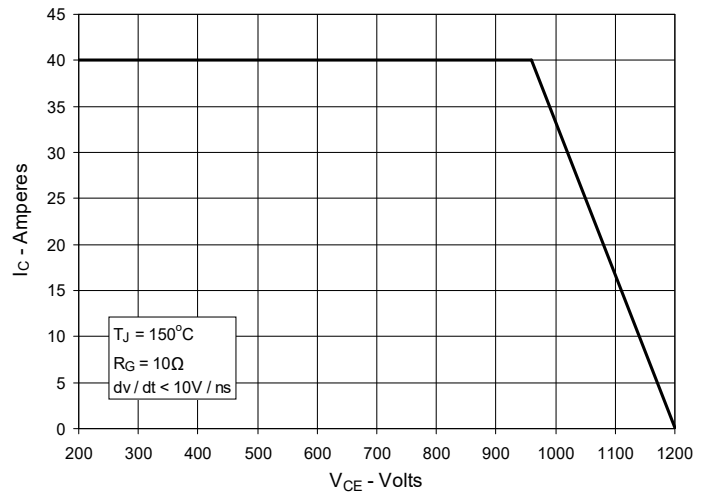

Fig. 11. Maximum Transient Thermal Impedance

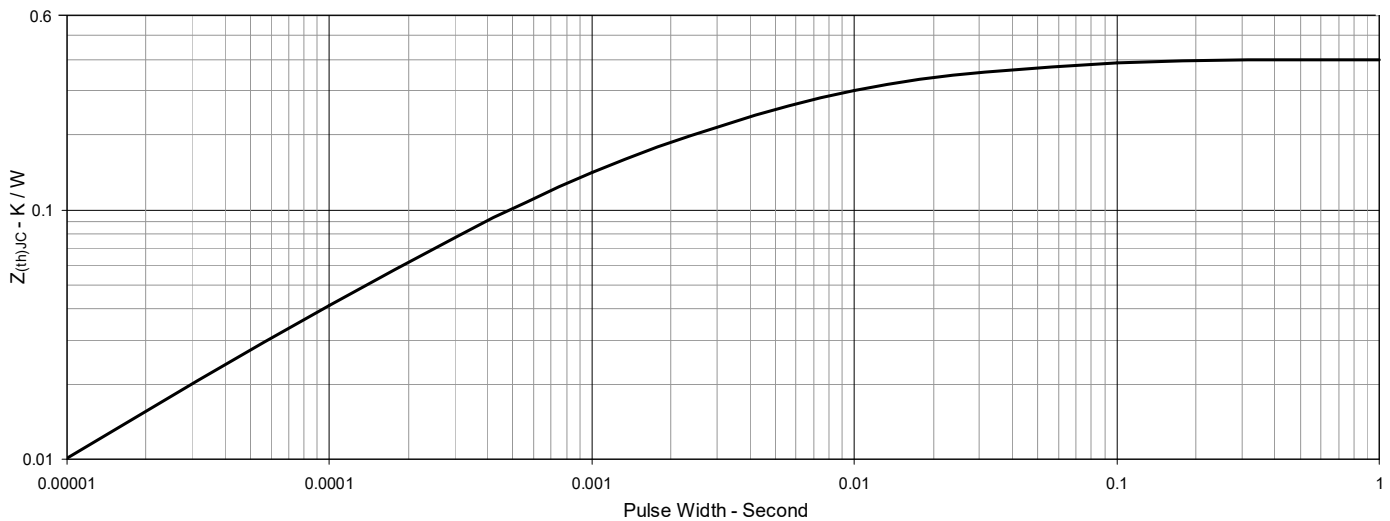

Fig. 12. Inductive Switching Energy Loss vs. Gate Resistance

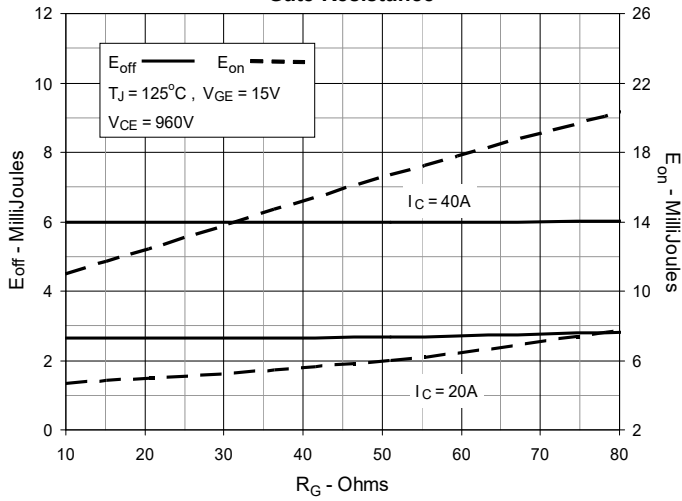

Fig. 13. Inductive Switching Energy Loss vs. Collector Current

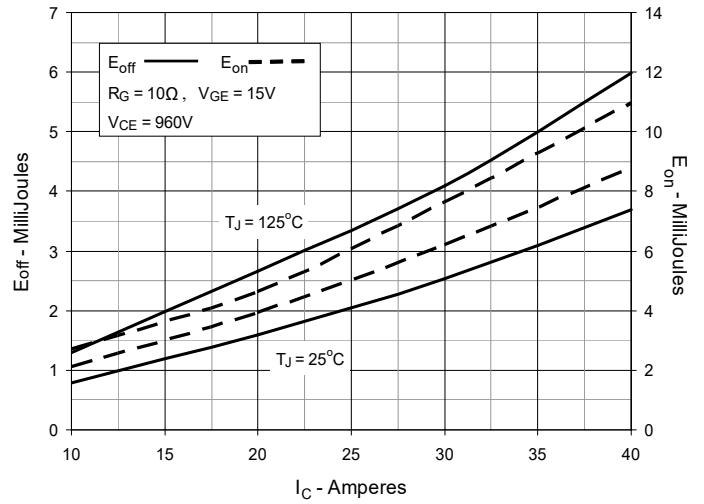

Fig. 14. Inductive Switching Energy Loss vs. Junction Temperature

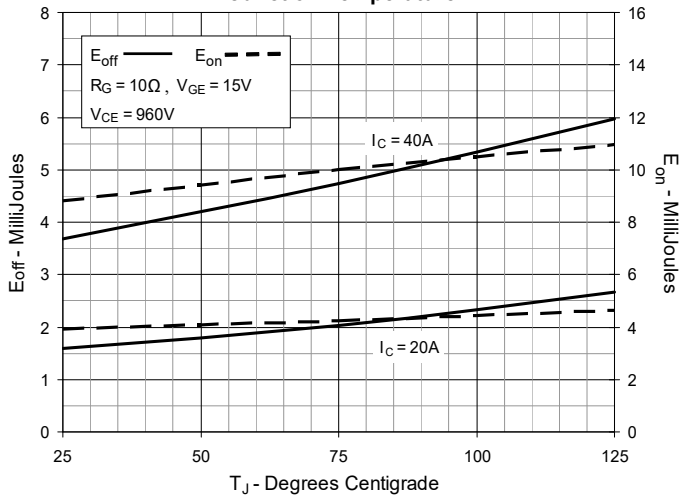

Fig. 15. Inductive Turn-off Switching Times vs. Gate Resistance

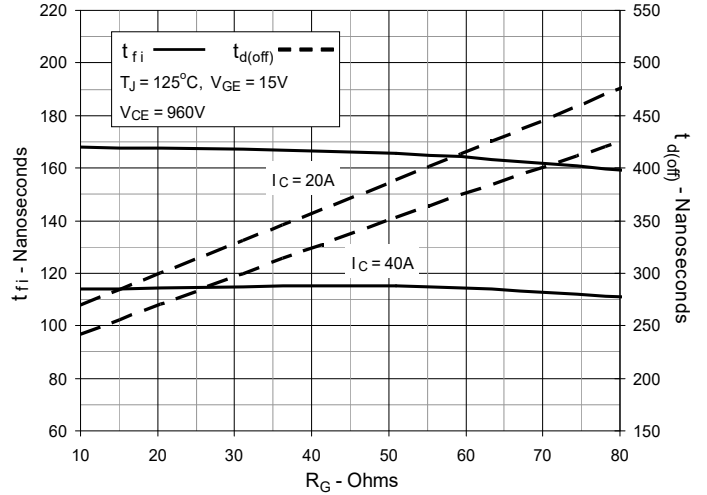

Fig. 16. Inductive Turn-off Switching Times vs. Collector Current

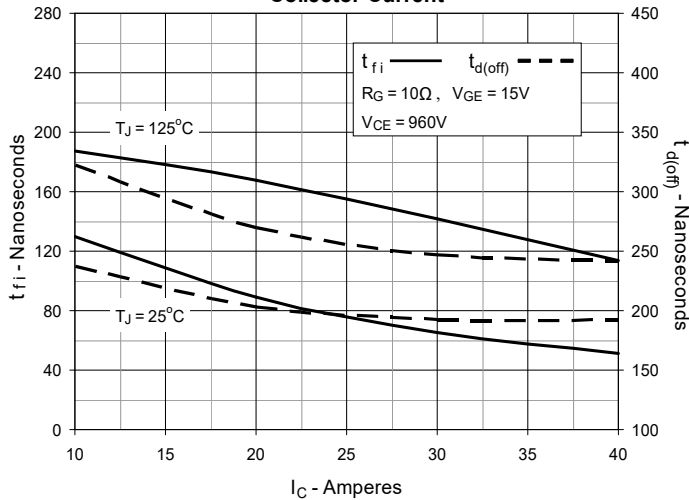

Fig. 17. Inductive Turn-off Switching Times vs. Junction Temperature

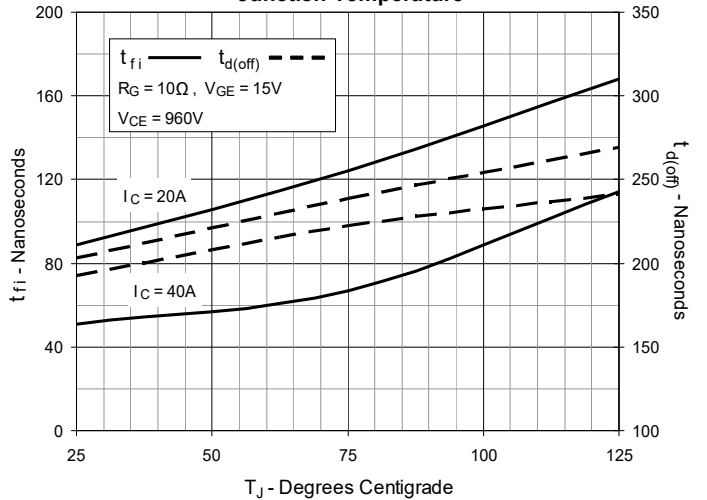

Fig. 18. Inductive Turn-on Switching Times vs. Gate Resistance

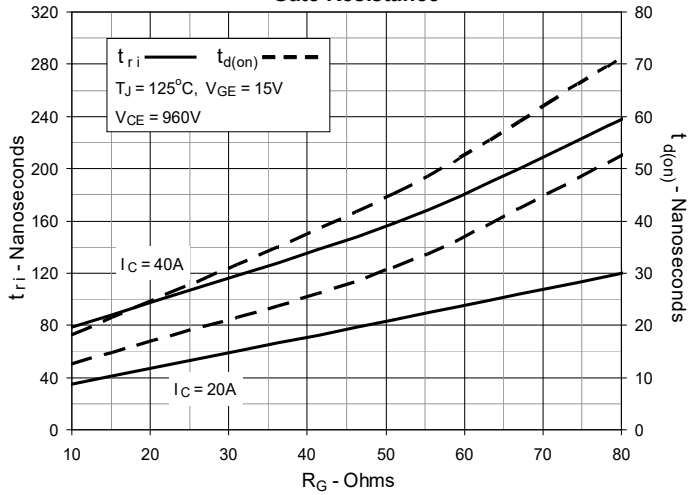

Fig. 19. Inductive Turn-on Switching Times vs. Collector Current

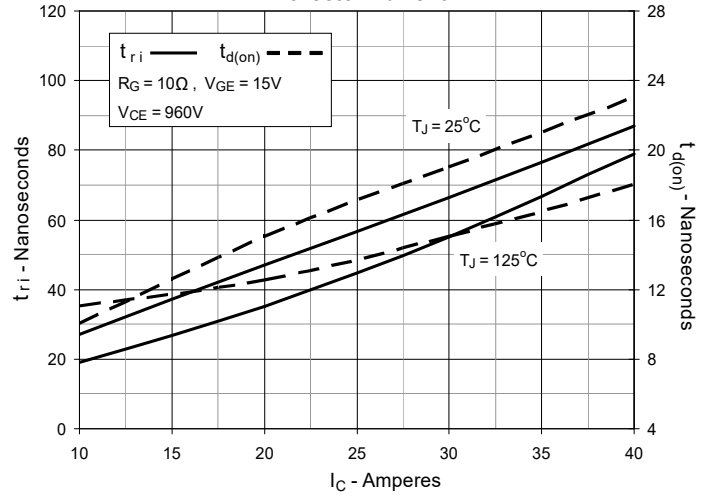
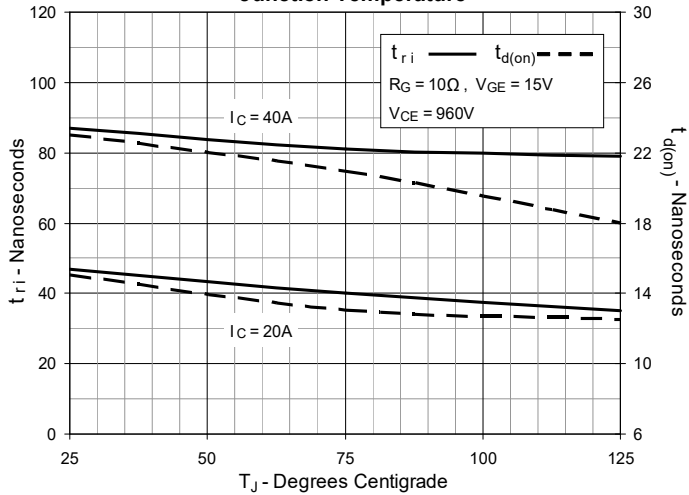
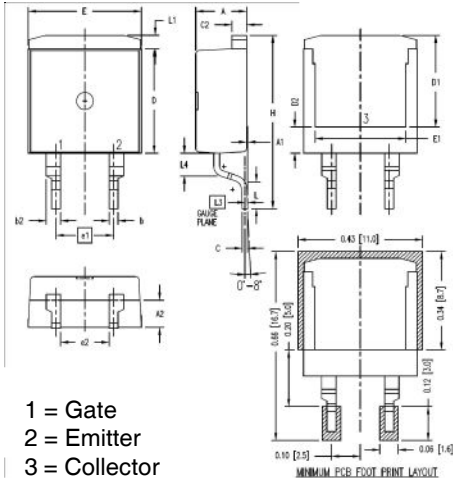
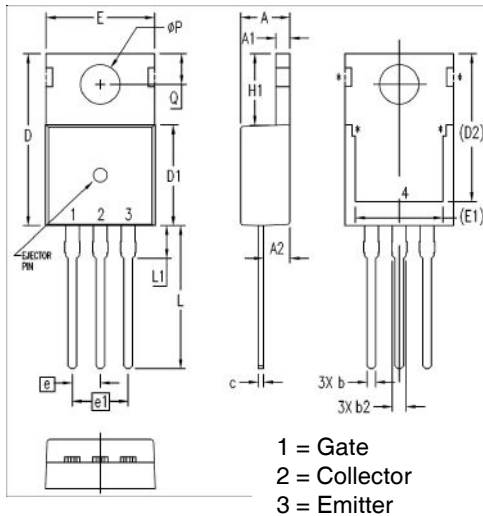

Fig. 20. Inductive Turn-on Switching Times vs. Junction Temperature



TO-263HV Outline

| SYM | INCHES | | MILLIMETER | |
|------|----------|------|------------|-------|
| | MIN | MAX | MIN | MAX |
| A | .170 | .185 | 4.30 | 4.70 |
| A1 | .000 | .008 | 0.00 | 0.20 |
| A2 | .091 | .098 | 2.30 | 2.50 |
| b | .028 | .035 | 0.70 | 0.90 |
| b2 | .046 | .054 | 1.18 | 1.38 |
| C | .018 | .024 | 0.45 | 0.60 |
| C2 | .049 | .055 | 1.25 | 1.40 |
| D | .354 | .370 | 9.00 | 9.40 |
| D1 | .311 | .327 | 7.90 | 8.30 |
| D2 | .083 | .098 | 2.10 | 2.50 |
| E | .386 | .402 | 9.80 | 10.20 |
| E1 | .307 | .323 | 7.80 | 8.20 |
| e1 | .200 BSC | | 5.08 BSC | |
| (e2) | .163 | .174 | 4.13 | 4.43 |
| H | .591 | .614 | 15.00 | 15.60 |
| L | .079 | .102 | 2.00 | 2.60 |
| L1 | .039 | .055 | 1.00 | 1.40 |
| L3 | .010 BSC | | 0.254 BSC | |
| (L4) | .071 | .087 | 1.80 | 2.20 |

TO-220 Outline

| SYM | INCHES | | MILLIMETERS | |
|------|----------|------|-------------|-------|
| | MIN | MAX | MIN | MAX |
| A | .169 | .185 | 4.30 | 4.70 |
| A1 | .047 | .055 | 1.20 | 1.40 |
| A2 | .079 | .106 | 2.00 | 2.70 |
| b | .024 | .039 | 0.60 | 1.00 |
| b2 | .045 | .057 | 1.15 | 1.45 |
| c | .014 | .026 | 0.35 | 0.65 |
| D | .587 | .626 | 14.90 | 15.90 |
| D1 | .335 | .370 | 8.50 | 9.40 |
| (D2) | .500 | .531 | 12.70 | 13.50 |
| E | .382 | .406 | 9.70 | 10.30 |
| (E1) | .283 | .323 | 7.20 | 8.20 |
| e | .100 BSC | | 2.54 BSC | |
| e1 | .200 BSC | | 5.08 BSC | |
| H1 | .244 | .268 | 6.20 | 6.80 |
| L | .492 | .547 | 12.50 | 13.90 |
| L1 | .110 | .154 | 2.80 | 3.90 |
| ØP | .134 | .150 | 3.40 | 3.80 |
| Q | .106 | .126 | 2.70 | 3.20 |



Disclaimer Notice - Information furnished is believed to be accurate and reliable. However, users should independently evaluate the suitability of and test each product selected for their own applications. Littelfuse products are not designed for, and may not be used in, all applications. Read complete Disclaimer Notice at www.littelfuse.com/disclaimer-electronics.

IXYS Reserves the Right to Change Limits, Test Conditions, and Dimensions.
