

NGB8202AN - 20 A, 400 V, N-Channel Ignition IGBT, D²PAK

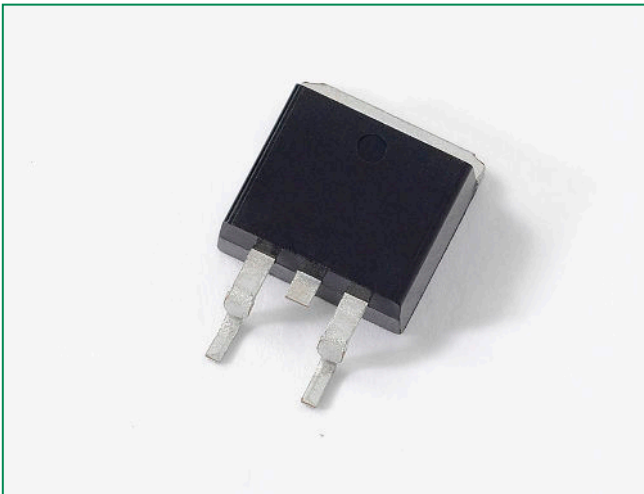

20 Amps, 400 Volts
 $V_{CE(on)} \leq 1.3 \text{ V @}$
 $I_C = 10 \text{ A, } V_{GE} \geq 4.5 \text{ V}$

Maximum Ratings (T_J = 25°C unless otherwise noted)

Rating	Symbol	Value	Unit
Collector–Emitter Voltage	V _{CES}	440	V
Collector–Gate Voltage	V _{CER}	440	V
Gate–Emitter Voltage	V _{GE}	±15	V
Collector Current–Continuous @ T _C = 25°C – Pulsed	I _C	20 50	A _{DC} A _{AC}
Continuous Gate Current	I _G	1.0	mA
Transient Gate Current (t ≤ 2 ms, f ≤ 100 Hz)	I _G	20	mA
ESD (Charged–Device Model)	ESD	2.0	kV
ESD (Human Body Model) R = 1500 Ω, C = 100 pF	ESD	8.0	kV
ESD (Machine Model) R = 0 Ω, C = 200 pF	ESD	500	V
Total Power Dissipation @ T _C = 25°C Derate above 25°C	P _D	150 1.0	Watts W/°C
Operating and Storage Temperature Range	T _J , T _{stg}	–55 to +175	°C

Description

This Logic Level Insulated Gate Bipolar Transistor (IGBT) features monolithic circuitry integrating ESD and Over–Voltage clamped protection for use in inductive coil drivers applications. Primary uses include Ignition, Direct Fuel Injection, or wherever high voltage and high current switching is required.

Features

- Ideal for Coil–on–Plug and Driver–on–Coil Applications
- Gate–Emitter ESD Protection
- Temperature Compensated Gate–Collector Voltage Clamp Limits Stress Applied to Load
- Integrated ESD Diode Protection
- Low Threshold Voltage for Interfacing Power Loads to Logic or Microprocessor Devices
- Low Saturation Voltage
- High Pulsed Current Capability
- These are Pb–Free Devices

Applications

- Ignition Systems

Functional Diagram

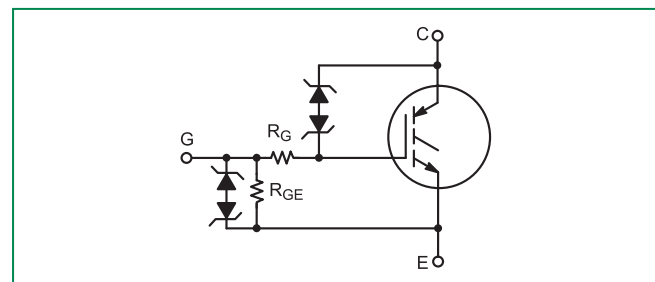

Additional Information



Datasheet



Resources



Samples

Stresses exceeding those listed in the Maximum Ratings table may damage the device. If any of these limits are exceeded, device functionality should not be assumed, damage may occur and reliability may be affected.

Unclamped Collector–To–Emitter Avalanche Characteristics ($-55^{\circ} \leq T_J \leq 175^{\circ}\text{C}$)

	Symbol	Value	Unit
Single Pulse Collector–to–Emitter Avalanche Energy			
$V_{CC} = 50\text{ V}, V_{GE} = 5.0\text{ V}, P_k, I_L = 16.7\text{ A}, R_G = 1000\ \Omega, L = 1.8\text{ mH}, \text{Starting } T_J = 25^{\circ}\text{C}$	E_{AS}	250	mJ
$V_{CC} = 50\text{ V}, V_{GE} = 5.0\text{ V}, P_k, I_L = 14.9\text{ A}, R_G = 1000\ \Omega, L = 1.8\text{ mH}, \text{Starting } T_J = 150^{\circ}\text{C}$		200	
$V_{CC} = 50\text{ V}, V_{GE} = 5.0\text{ V}, P_k, I_L = 14.1\text{ A}, R_G = 1000\ \Omega, L = 1.8\text{ mH}, \text{Starting } T_J = 175^{\circ}\text{C}$		180	
Reverse Avalanche Energy			
$V_{CC} = 100\text{ V}, V_{GE} = 20\text{ V}, P_k, I_L = 25.8\text{ A}, L = 6.0\text{ mH}, \text{Starting } T_J = 25^{\circ}\text{C}$	$E_{AS(R)}$	2000	mJ

Thermal Characteristics

	Symbol	Value	Unit
Thermal Resistance, Junction to Case	$R_{\theta JC}$	1.0	$^{\circ}\text{C}/\text{W}$
Thermal Resistance, Junction to Ambient (Note 1)	$R_{\theta JA}$	62.5	$^{\circ}\text{C}/\text{W}$
Maximum Lead Temperature for Soldering Purposes, 1/8" from case for 5 seconds	T_L	275	$^{\circ}\text{C}$

1. When surface mounted to an FR4 board using the minimum recommended pad size.

Electrical Characteristics - OFF

Characteristic	Symbol	Test Conditions	Temperature	Min	Typ	Max	Unit
Collector–Emitter Clamp Voltage	BV_{CES}	$I_C = 2.0 \text{ mA}$	$T_J = -40^\circ\text{C}$ to 175°C	370	395	420	V
		$I_C = 10 \text{ mA}$	$T_J = -40^\circ\text{C}$ to 175°C	390	415	440	
Zero Gate Voltage Collector Current	I_{CES}	$V_{GE} = 0 \text{ V}$, $V_{CE} = 15 \text{ V}$	$T_J = 25^\circ\text{C}$	–	0.1	1.0	μA
			$T_J = 175^\circ\text{C}$	0.5	1.5	10	
			$T_J = -40^\circ\text{C}$	1.0	25	100*	
Reverse Collector–Emitter Clamp Voltage	$B_{V_{CES(R)}}$	$I_C = -75 \text{ mA}$	$T_J = 25^\circ\text{C}$	30	35	39	V
			$T_J = 175^\circ\text{C}$	35	39	45*	
			$T_J = -40^\circ\text{C}$	30	33	37	
Reverse Collector–Emitter Leakage Current	$I_{CES(R)}$	$V_{CE} = -24 \text{ V}$	$T_J = 25^\circ\text{C}$	0.05	0.2	1.0	mA
			$T_J = 175^\circ\text{C}$	1.0	8.5	25	
			$T_J = -40^\circ\text{C}$	0.005	0.025	0.2	
Gate–Emitter Clamp Voltage	BV_{GES}	$I_G = \pm 5.0 \text{ mA}$	$T_J = -40^\circ\text{C}$ to 175°C	12	12.5	14	V
Gate–Emitter Leakage Current	I_{GES}	$V_{GE} = \pm 5.0 \text{ V}$	$T_J = -40^\circ\text{C}$ to 175°C	200	300	350*	μA
Gate Resistor	R_G	–	$T_J = -40^\circ\text{C}$ to 175°C	–	70	–	Ω
Gate Emitter Resistor	R_{GE}	–	$T_J = -40^\circ\text{C}$ to 175°C	14.25	16	25	k Ω

Electrical Characteristics - ON (Note 3)

Characteristic	Symbol	Test Conditions	Temperature	Min	Typ	Max	Unit
Gate Threshold Voltage	$V_{GE(th)}$	$I_C = 1.0 \text{ mA}$, $V_{GE} = V_{CE}$	$T_J = 25^\circ\text{C}$	1.5	1.8	2.1	V
			$T_J = 175^\circ\text{C}$	0.7	1.0	1.3	
			$T_J = -40^\circ\text{C}$	1.7	2.0	2.3*	
Threshold Temperature Coefficient (Negative)	–	–	–	4.0	4.6	5.2	mV/ $^\circ\text{C}$

*Maximum Value of Characteristic across Temperature Range.
 3. Pulse Test: Pulse Width $\leq 300 \mu\text{s}$, Duty Cycle $\leq 2\%$.

Electrical Characteristics - ON (Note 4)

Characteristic	Symbol	Test Conditions	Temperature	Min	Typ	Max	Unit
Collector-to-Emitter On-Voltage	$V_{CE(on)}$	$I_C = 6.5\text{ A}$, $V_{GE} = 3.7\text{ V}$	$T_J = 25^\circ\text{C}$	0.85	1.03	1.35	V
			$T_J = 175^\circ\text{C}$	0.7	0.9	1.15	
			$T_J = -40^\circ\text{C}$	0	1.11	1.4	
		$I_C = 9.0\text{ A}$, $V_{GE} = 3.9\text{ V}$	$T_J = 25^\circ\text{C}$	0.9	1.11	1.45	
			$T_J = 175^\circ\text{C}$	0.8	1.01	1.25	
			$T_J = -40^\circ\text{C}$	1.0	1.18	1.5	
		$I_C = 7.5\text{ A}$, $V_{GE} = 4.5\text{ V}$	$T_J = 25^\circ\text{C}$	0.85	1.15	1.4	
			$T_J = 175^\circ\text{C}$	0.7	0.95	1.2	
			$T_J = -40^\circ\text{C}$	1.0	1.3	1.6*	
		$I_C = 10\text{ A}$, $V_{GE} = 4.5\text{ V}$	$T_J = 25^\circ\text{C}$	1.0	1.3	1.6	
			$T_J = 175^\circ\text{C}$	0.8	1.05	1.4	
			$T_J = -40^\circ\text{C}$	1.1	1.4	1.7*	
		$I_C = 15\text{ A}$, $V_{GE} = 4.5\text{ V}$	$T_J = 25^\circ\text{C}$	1.15	1.45	1.7	
			$T_J = 175^\circ\text{C}$	1.0	1.3	1.55	
			$T_J = -40^\circ\text{C}$	1.25	1.55	1.8*	
$I_C = 20\text{ A}$, $V_{GE} = 4.5\text{ V}$	$T_J = 25^\circ\text{C}$	1.1	1.4	1.9			
	$T_J = 175^\circ\text{C}$	1.2	1.5	1.8			
	$T_J = -40^\circ\text{C}$	1.3	1.42	2.0			
Forward Transconductance	gfs	$V_{CE} = 5.0\text{ V}$, $I_C = 6.0\text{ A}$	$T_J = 25^\circ\text{C}$	10	18	25	Mhos

Dynamic Characteristics

Characteristic	Symbol	Test Conditions	Temperature	Min	Typ	Max	Unit
Input Capacitance	C_{ISS}	$V_{CE} = 25\text{ V}$ $f = 10\text{ kHz}$	$T_J = 25^\circ\text{C}$	1100	1300	1500	pF
Output Capacitance	C_{OSS}			70	80	90	
Transfer Capacitance	C_{RSS}			18	20	22	

Switching Characteristics

Characteristic	Symbol	Test Conditions	Temperature	Min	Typ	Max	Unit
Turn-Off Delay Time (Resistive)	$t_{d(off)}$	$V_{CC} = 300\text{ V}$, $I_C = 9\text{ A}$ $R_G = 1.0\text{ k}\Omega$, $R_L = 33\ \Omega$, $V_{GE} = 5.0\text{ V}$	$T_J = 25^\circ\text{C}$	6.0	8.0	10	μSec
			$T_J = 175^\circ\text{C}$	6.0	8.0	10	
Fall Time (Resistive)	t_f		$T_J = 25^\circ\text{C}$	4.0	6.0	8.0	
			$T_J = 175^\circ\text{C}$	8.0	10.5	14	
Turn-Off Delay Time (Inductive)	$t_{d(off)}$		$T_J = 25^\circ\text{C}$	3.0	5.0	7.0	
			$T_J = 175^\circ\text{C}$	5.0	7.0	9.0	
Fall Time (Inductive)	t_f		$T_J = 25^\circ\text{C}$	1.5	3.0	4.5	
			$T_J = 175^\circ\text{C}$	5.0	7.0	10	
Turn-On Delay Time	$t_{d(on)}$	$T_J = 25^\circ\text{C}$	1.0	1.5	2.0		
		$T_J = 175^\circ\text{C}$	1.0	1.5	2.0		
Rise Time	t_r	$T_J = 25^\circ\text{C}$	4.0	6.0	8.0		
		$T_J = 175^\circ\text{C}$	3.0	5.0	7.0		

4. Pulse Test: Pulse Width $\leq 300\ \mu\text{s}$, Duty Cycle $\leq 2\%$.

*Maximum Value of Characteristic across Temperature Range.

Product parametric performance is indicated in the Electrical Characteristics for the listed test conditions, unless otherwise noted. Product performance may not be indicated by the Electrical Characteristics if operated under different conditions.

Ratings and Characteristic Curves

Figure 1. Self Clamped Inductive Switching

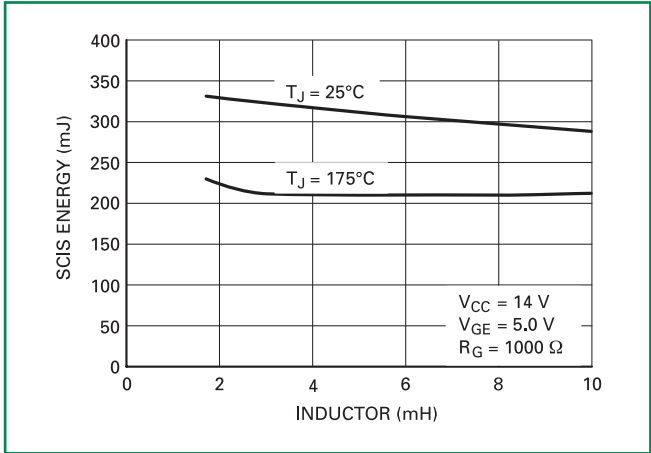

Figure 2. Open Secondary Avalanche Current vs. Temperature

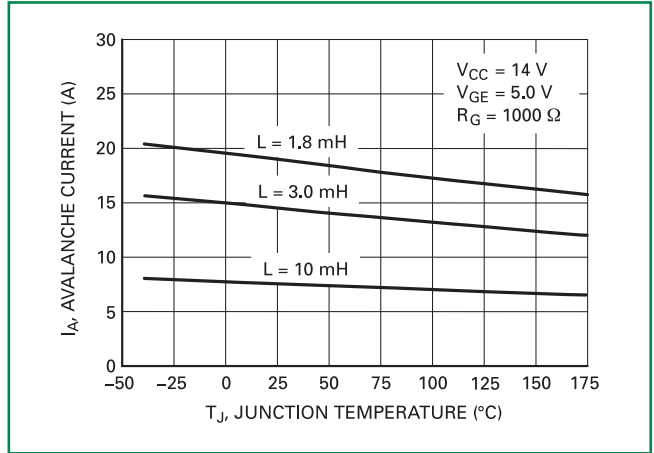

Figure 3. Collector-to-Emitter Voltage vs. Junction Temperature

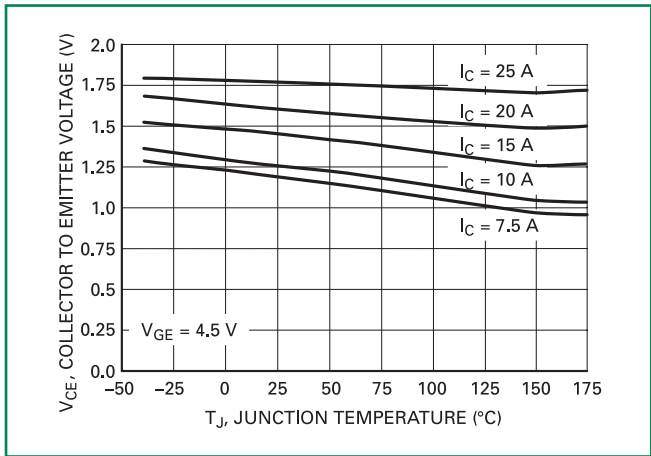

Figure 4. Collector Current vs. Collector-to-Emitter Voltage

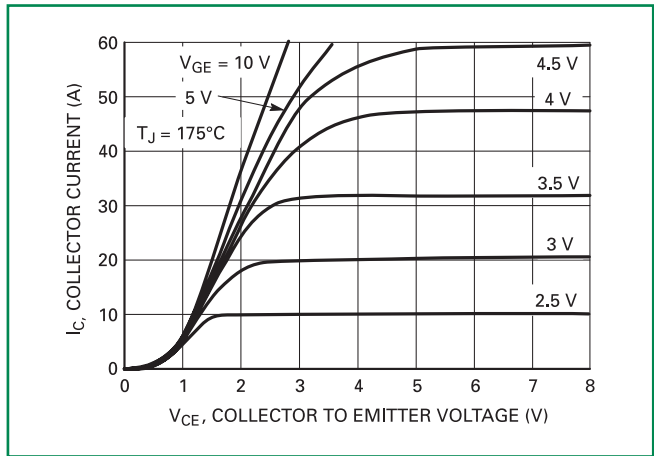

Figure 5. Collector Current vs. Collector-to-Emitter Voltage

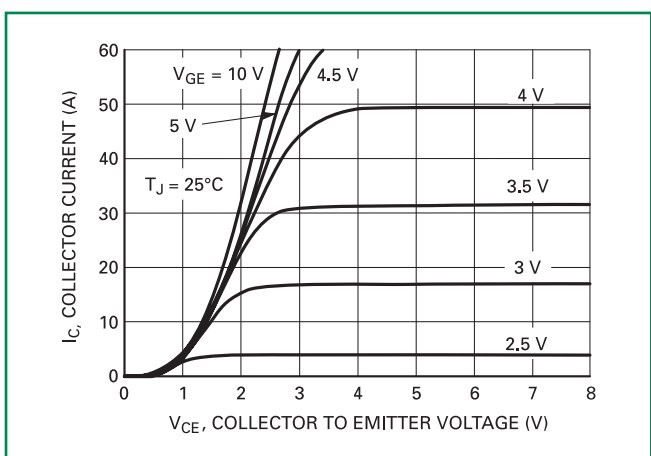

Figure 6. Collector Current vs. Collector-to-Emitter Voltage

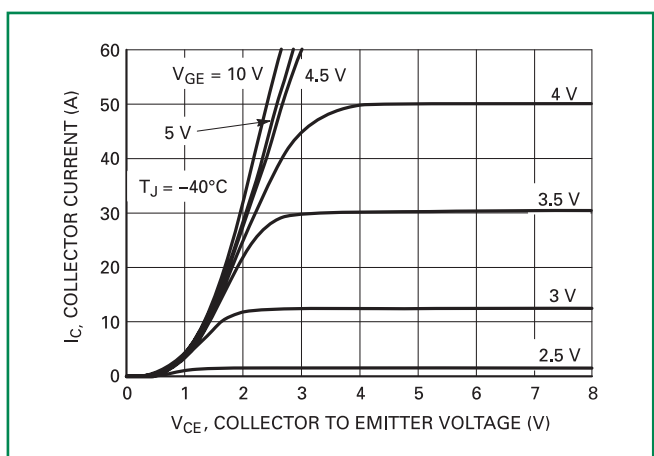

Figure 7. Transfer Characteristics

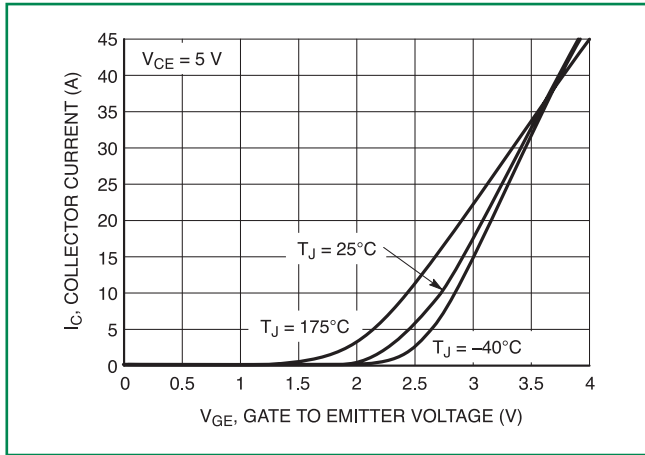

Figure 8. Collector-to-Emitter Leakage Current vs. Temperature

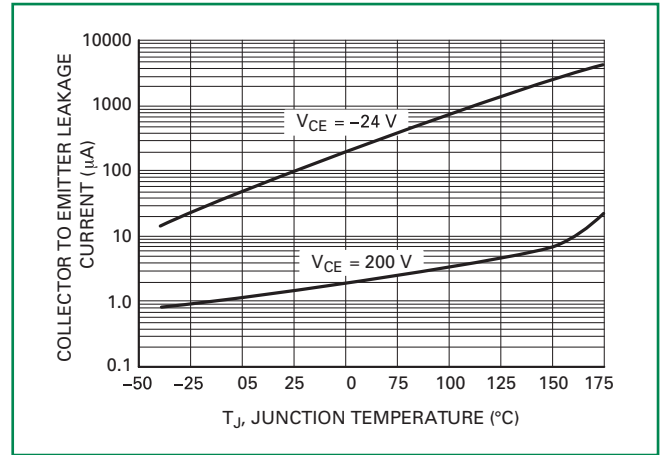

Figure 9. Gate Threshold Voltage vs. Temperature

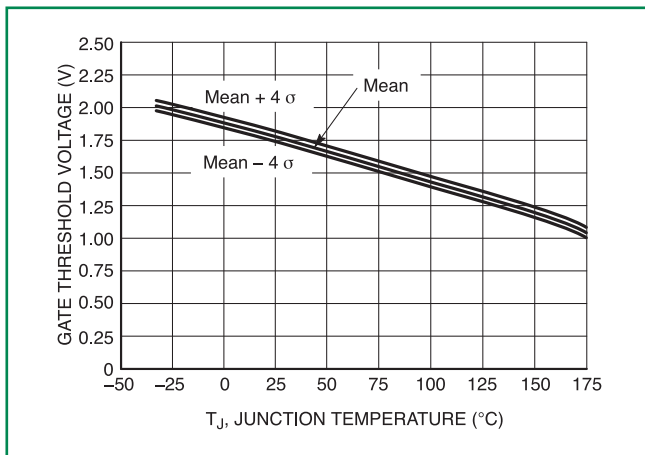

Figure 10. Capacitance vs. Collector-to-Emitter Voltage

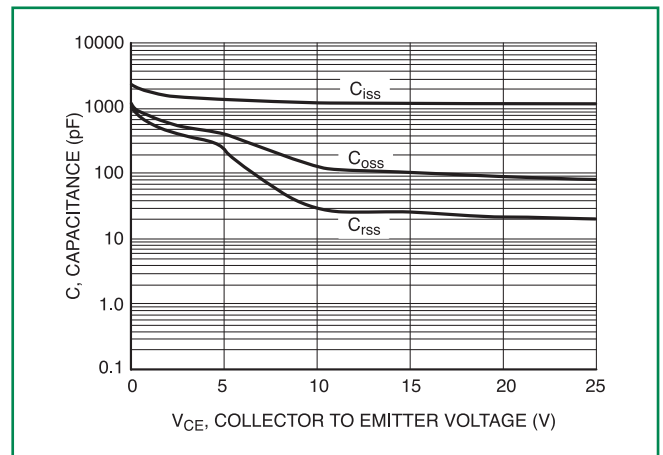

Figure 11. Resistive Switching Fall Time vs. Temperature

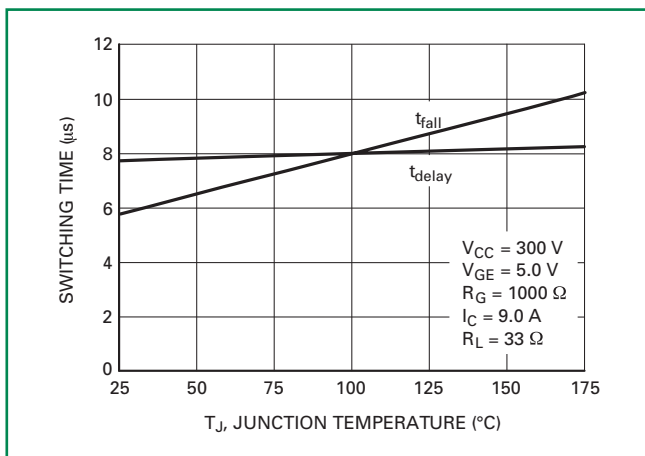

Figure 12. Inductive Switching Fall Time vs. Temperature

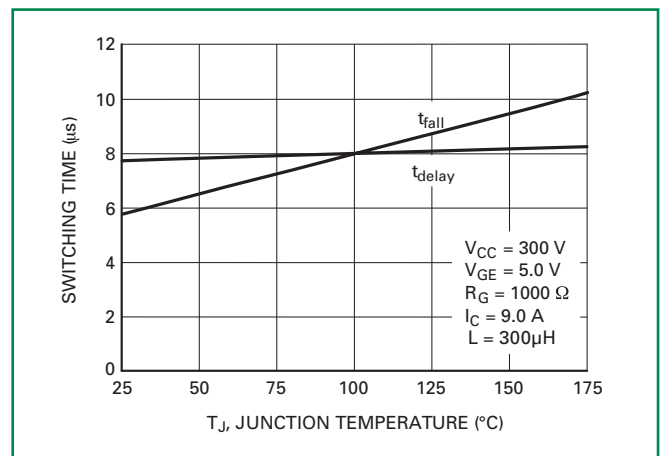

Figure 13. Minimum Pad Transient Thermal Resistance (Non-normalized Junction-to-Ambient)

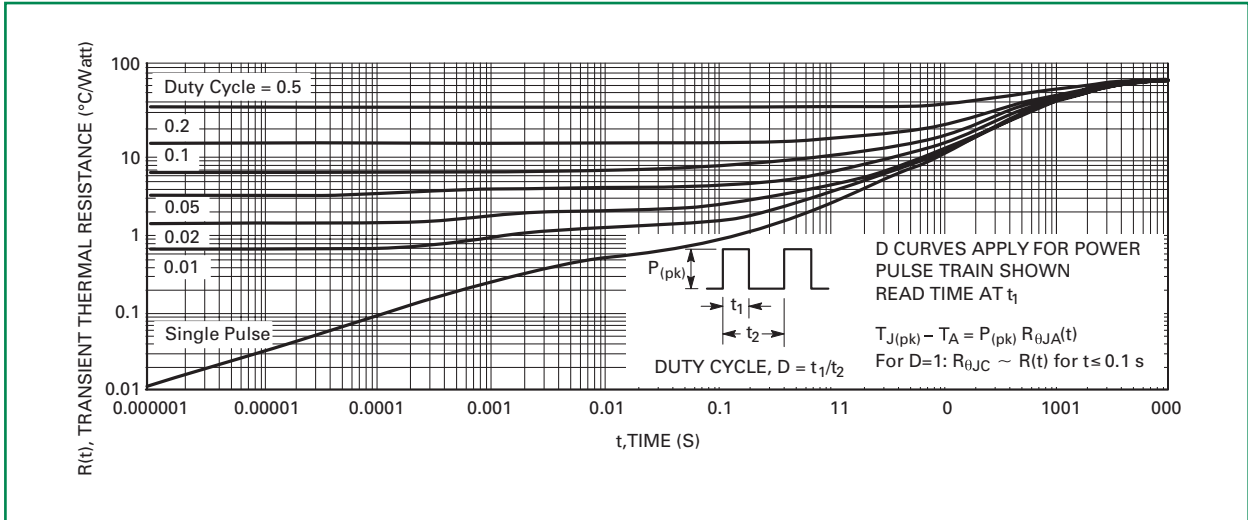

Figure 14. Best Case Transient Thermal Resistance (Non-normalized Junction-to-Case Mounted on Cold Plate)

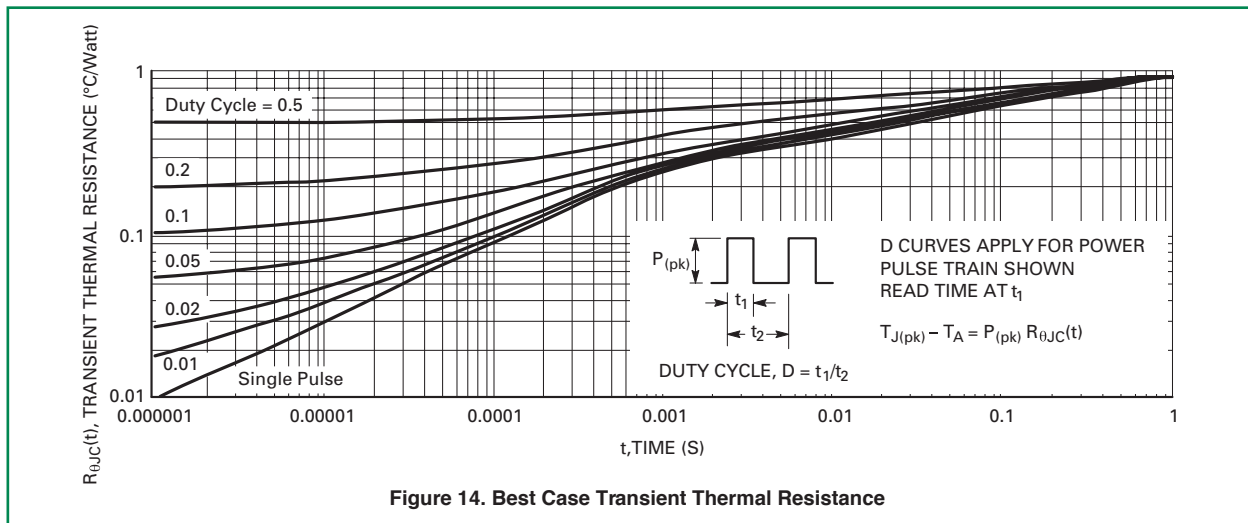
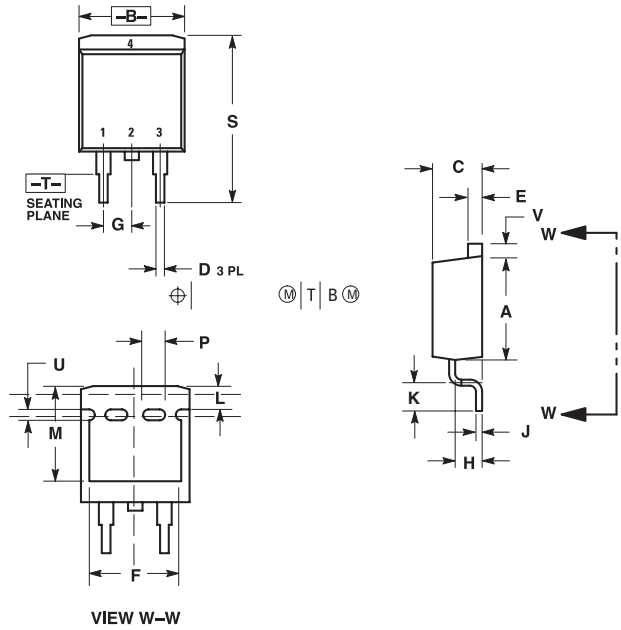

Figure 14. Best Case Transient Thermal Resistance

Dimensions



Dim	Inches		Millimeters	
	Min	Max	Min	Max
A	0.340	0.380	8.64	9.65
B	0.380	0.405	9.65	10.29
C	0.160	0.190	4.06	4.83
D	0.020	0.035	0.51	0.89
E	0.045	0.055	1.14	1.40
F	0.310	0.350	7.87	8.89
G	0.100 BSC		2.54 BSC	
H	0.080	0.110	2.03	2.79
J	0.018	0.025	0.46	0.64
K	0.090	0.110	2.29	2.79
L	0.052	0.072	1.32	1.83
M	0.280	0.320	7.11	8.13
N	0.197 REF		5.00 REF	
P	0.079 REF		2.00 REF	
R	0.039 REF		0.99 REF	
S	0.575	0.625	14.60	15.88
V	0.045	0.055	1.14	1.40

- NOTES:
1. DIMENSIONING AND TOLERANCING PER ANSI Y14.5M, 1982.
 2. CONTROLLING DIMENSION: INCH.
 3. 418B-01 THRU 418B-03 OBSOLETE, NEW STANDARD 418B-04.

Soldering Footprint

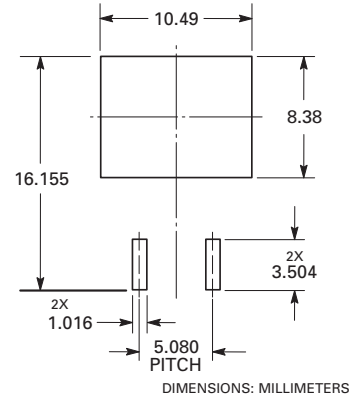

Part Marking System

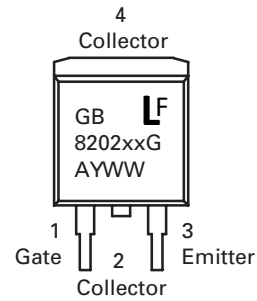

GB8202xx = Device Code
xx = AN
A = Assembly Location
Y = Year
WW = Work Week
G = Pb-Free Package

ORDERING INFORMATION

Device	Package	Shipping
NGB8202ANT4G	D2PAK (Pb-Free)	800 / Tape & Reel
NGB8202ANTF4G		700 / Tape & Reel

Disclaimer Notice - Information furnished is believed to be accurate and reliable. However, users should independently evaluate the suitability of and test each product selected for their own applications. Littelfuse products are not designed for, and may not be used in, all applications. Read complete Disclaimer Notice at: www.littelfuse.com/disclaimer-electronics.