

 **Insulated Gate Bipolar Transistor**

Features

- ▶ Low voltage drop at high currents
- ▶ Industry standard TO-252 (D-Pak) package
- ▶ 700V breakdown voltage rating

Applications

- ▶ White goods
- ▶ Small appliances
- ▶ Lighting controls
- ▶ Motor drives
- ▶ Meter readers
- ▶ Small off-line power supplies

General Description

The Supertex GN2470 is a 700V, 3.5amp insulated gate bipolar transistor (IGBT) that combines the positive aspects of both BJTs and MOSFETs.

The GN2470 IGBT has lower on-state voltage drop with high blocking voltage capabilities and features many desirable properties including a MOS input gate, low conduction voltage drop at high currents.

Ordering Information

Device	Package Option
	TO-252 (D-PAK)
GN2470	GN2470K4-G

-G indicates that the package is RoHS certified ("Green")



Pin Configuration

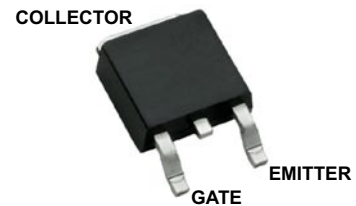

TO-252 (D-PAK) (K4)

Pin Configuration

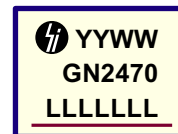

YY = Year Sealed
 WW = Week Sealed
 L = Lot Number
 _____ = "Green" Packaging

TO-252 (D-PAK) (K4)

Absolute Maximum Ratings

Parameter	Value
Collector-to-emitter voltage	700V
Gate-to-emitter voltage	±20V
Operating junction and storage temperature range	-55°C to +150°C
Soldering temperature*	300°C

Absolute Maximum Ratings are those values beyond which damage to the device may occur. Functional operation under these conditions is not implied. Continuous operation of the device at the absolute rating level may affect device reliability. All voltages are referenced to device ground.

* Distance of 1.6mm from case for 10 seconds.

Thermal Characteristics

Package	I_C (continuous)	I_C (pulsed)	Power Dissipation @ $T_A = 25^\circ\text{C}$	θ_{jc} ($^\circ\text{C/W}$)	θ_{ja} ($^\circ\text{C/W}$)
TO-252	1.0A	3.5A	2.5W	10	60†

Notes:

† Mounted on FR4 board, 25mm x 25mm x 1.57mm

Electrical Characteristics ($T_A = 25^\circ\text{C}$ unless otherwise specified)

Sym	Parameter	Min	Typ	Max	Units	Conditions
BV_{CES}	Collector-to-emitter breakdown voltage	700	-	-	V	$V_{GE} = 0V, I_C = 250\mu\text{A}$
BV_{ECS}	Emitter-to-collector breakdown voltage	-6.0	-10	-	V	$V_{GE} = 0V, I_C = 1.0\text{mA}$
$V_{GE(th)}$	Gate threshold voltage	1.5	-	3.5	V	$V_{CE} = V_{GE}, I_C = 1.0\text{mA}$
V_{CE}	Collector-to-emitter voltage drop	-	4.5	5.0	V	$I_C = 3.0\text{A}, V_{GE} = 13V$
g_{fe}	Forward transconductance	0.5	0.8	-	mho	$V_{CE} = 25V, I_C = 2.0\text{A}$
I_{CES}	Zero gate voltage collector current	-	-	100	μA	$V_{GE} = 0V, V_{CE} = 600V$
I_{GES}	Gate-to-emitter leakage current	-	-	± 100	nA	$V_{GE} = \pm 20V, V_{CE} = 0V$
$I_{C(ON)}$	On-state collector current	3.0	4.0	-	A	$V_{GE} = 10V, V_{CE} = 25V$
$t_{d(ON)}$	Turn-on delay time	-	8.0	15	ns	$V_{CC} = 25V$ $R_{GEN} = 25\Omega$ $R_L = 11\Omega$
t_r	Rise time	-	400	600		
$t_{d(OFF)}$	Turn-off delay time	-	20	50		
t_f	Fall time	-	7000	12000		
C_{ISS}	Input capacitance	-	100	150	pF	$V_{CE} = 25V$ $V_{GE} = 0V$ $f = 1\text{MHz}$
C_{OSS}	Output capacitance	-	12	25		
C_{RSS}	Reverse transfer capacitance	-	2	5		

Notes:

1. All D.C. parameters 100% tested at 25°C unless otherwise stated. (Pulse test: 300 μs pulse, 2% duty cycle.)
2. All A.C. parameters sample tested.

Switching Waveforms and Test Circuit

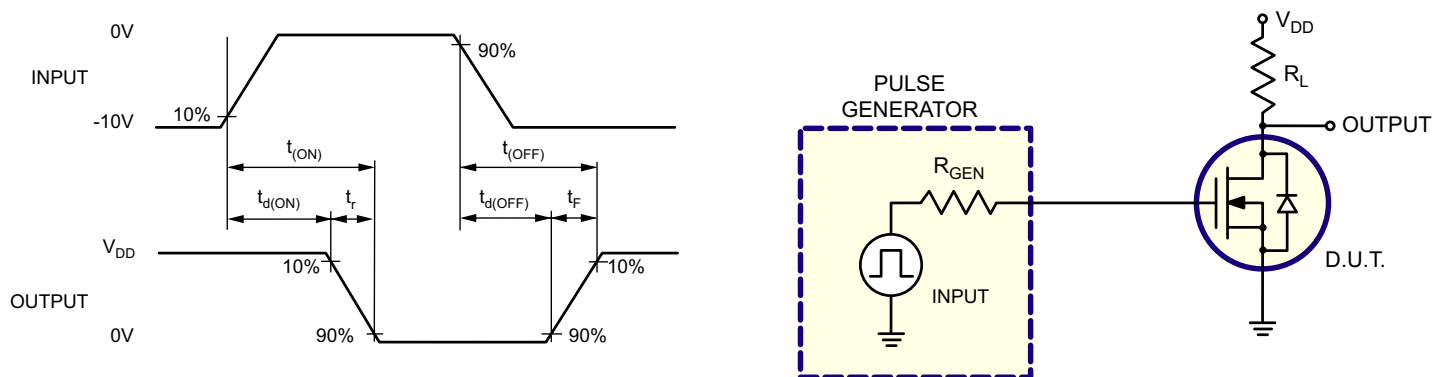

Typical Performance Waveform

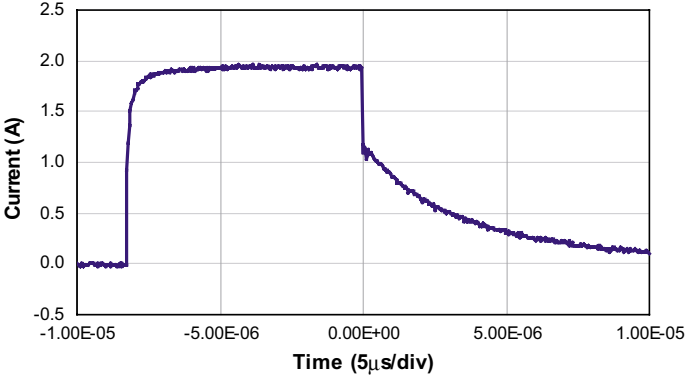

Equivalent Circuit

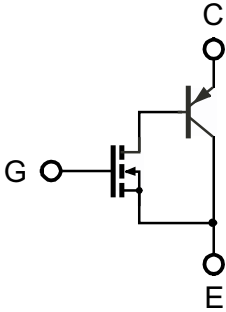

Saturation Characteristics

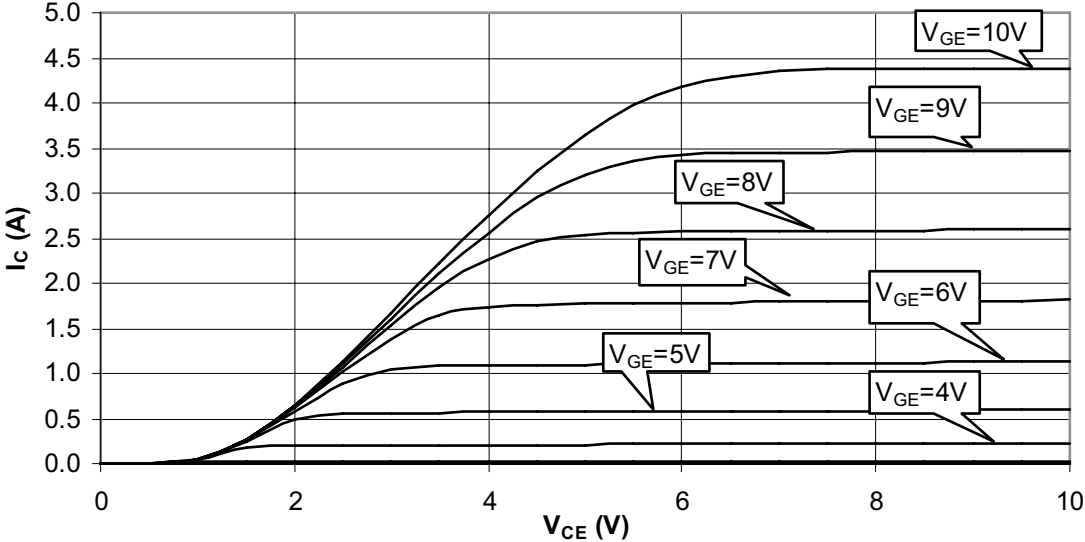

Transfer Characteristics

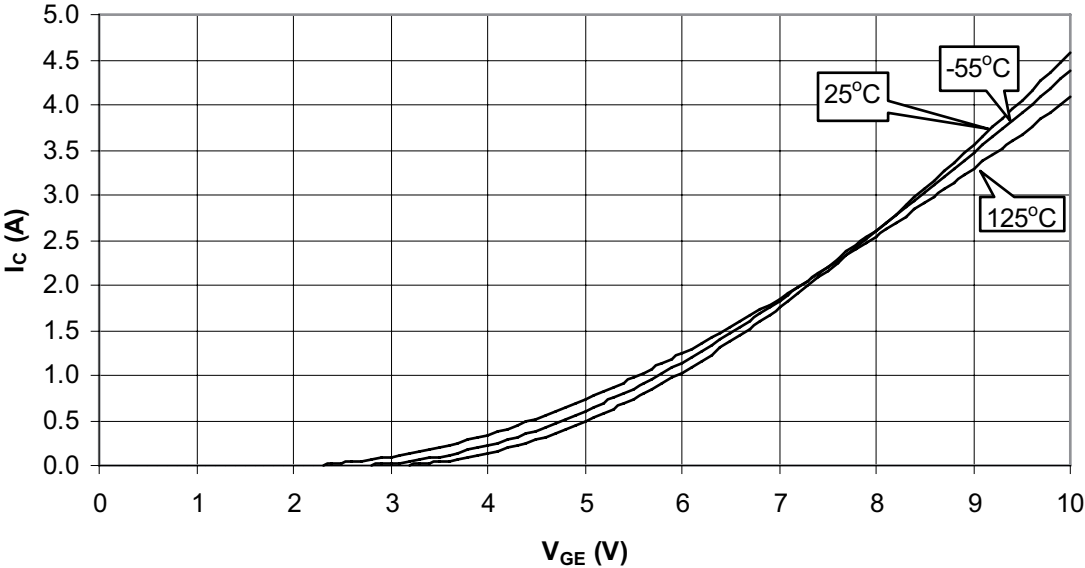

$V_{GE(th)}$ Variation with Temperature

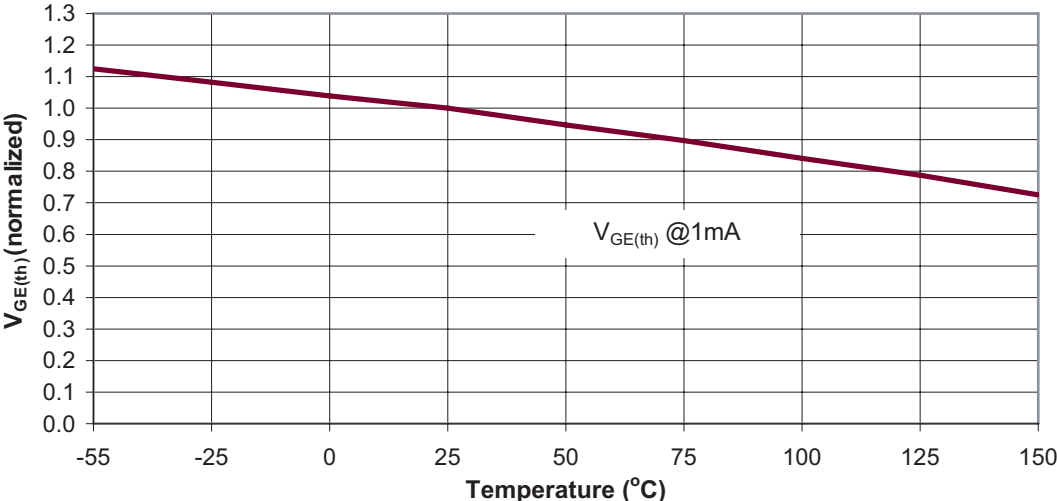

BV_{CES} Variation with Temperature

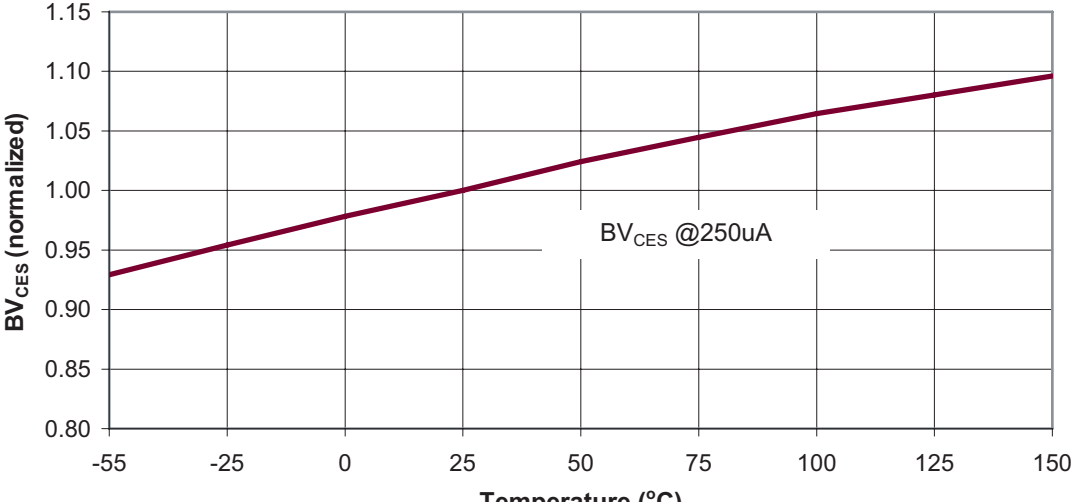

Transconductance vs. Collector Current

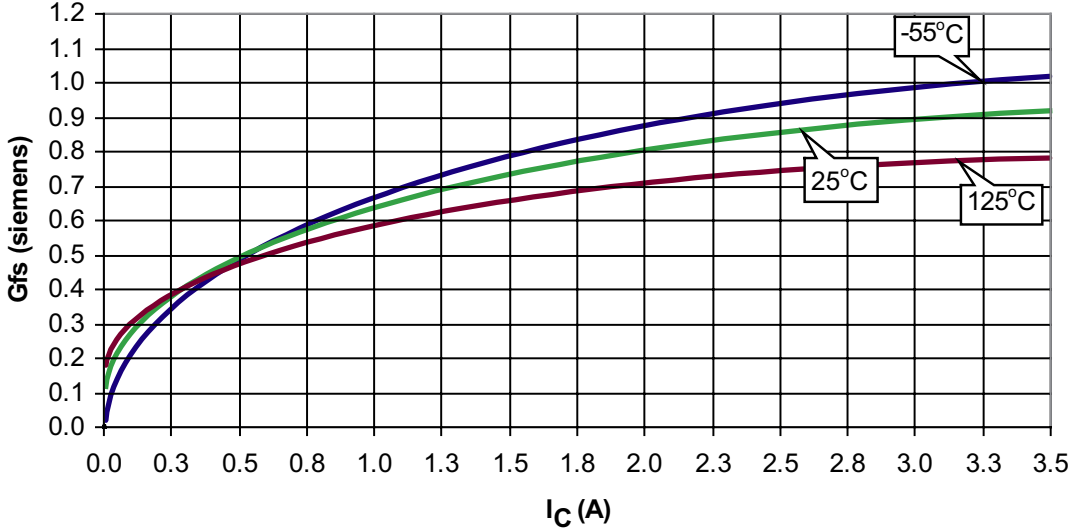

3-Lead TO-252 D-PAK Package Outline (K4)

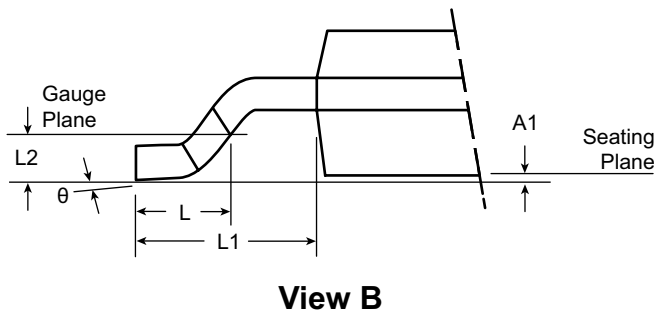
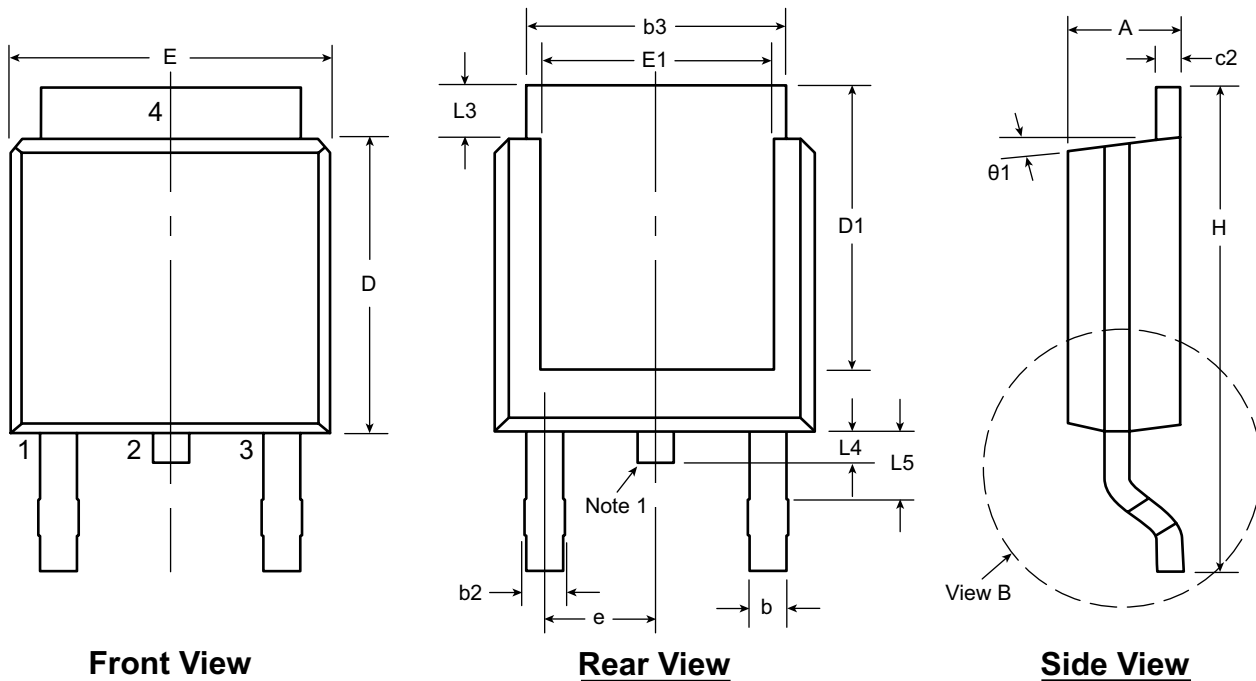

Note:
 1. Although 4 terminal locations are shown, only 3 are functional. Lead number 2 was removed.

Symbol	A	A1	b	b2	b3	c2	D	D1	E	E1	e	H	L	L1	L2	L3	L4	L5	θ	θ_1			
Dimension (inches)	MIN	.086	.000*	.025	.030	.195	.235	.205	.250	.170	.090 BSC	.370	.055	.108 REF	.020 BSC	.035	.025*	.045	0°	0°			
	NOM	-	-	-	-	-	.240	-	-	-		-	.060			-	-	-	-	-	-	-	-
	MAX	.094	.005	.035	.045	.215	.035	.245	.217*	.265		.182*	.410			.070	-	-	.050	.040	.060	10°	15°

JEDEC Registration TO-252, Variation AA, Issue E, June 2004.
 * This dimension is not specified in the original JEDEC drawing. The value listed is for reference only.
Drawings not to scale.
Supertex Doc. #: DSPD-3TO252K4, Version D081408.

(The package drawing(s) in this data sheet may not reflect the most current specifications. For the latest package outline information go to <http://www.supertex.com/packaging.html>.)

Supertex inc. does not recommend the use of its products in life support applications, and will not knowingly sell them for use in such applications unless it receives an adequate "product liability indemnification insurance agreement." Supertex inc. does not assume responsibility for use of devices described, and limits its liability to the replacement of the devices determined defective due to workmanship. No responsibility is assumed for possible omissions and inaccuracies. Circuitry and specifications are subject to change without notice. For the latest product specifications refer to the Supertex inc. website: <http://www.supertex.com>.