

MOSFET - POWERTRENCH[®]

N-Channel

80 V, 300 A, 1.4 mΩ



ON Semiconductor[®]

www.onsemi.com

Features

- Typical $R_{DS(on)}$ = 1.1 mΩ at $V_{GS} = 10$ V, $I_D = 80$ A
- Typical $Q_{g(tot)}$ = 172 nC at $V_{GS} = 10$ V, $I_D = 80$ A
- UIS Capability
- AEC-Q101 Qualified and PPAP Capable
- These Devices are Pb-Free and are RoHS Compliant

Applications

- Automotive Engine Control
- PowerTrain Management
- Solenoid and Motor Drivers
- Integrated Starter/Alternator
- Primary Switch for 12 V Systems

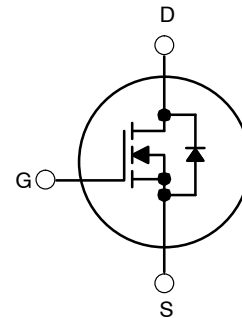

N-Channel



H-PSOF8L
CASE 100CU

MOSFET MAXIMUM RATINGS ($T_J = 25^\circ\text{C}$ unless otherwise noted)

Symbol	Parameter	Ratings	Unit
V_{DSS}	Drain-to-Source Voltage	80	V
V_{GS}	Gate-to-Source Voltage	± 20	V
I_D	Drain Current – Continuous ($V_{GS} = 10$), $T_C = 25^\circ\text{C}$ (Note 1)	300	A
	Pulsed Drain Current, $T_C = 25^\circ\text{C}$	See Figure 4	
E_{AS}	Single Pulse Avalanche Energy (Note 2)	820	mJ
P_D	Power Dissipation	429	W
	Derate Above 25°C	2.86	W/ $^\circ\text{C}$
T_J, T_{STG}	Operating and Storage Temperature	-55 to $+175$	$^\circ\text{C}$
$R_{\theta JC}$	Thermal Resistance, Junction to Case	0.35	$^\circ\text{C}/\text{W}$
$R_{\theta JA}$	Maximum Thermal Resistance, Junction to Ambient (Note 3)	43	$^\circ\text{C}/\text{W}$

Stresses exceeding those listed in the Maximum Ratings table may damage the device. If any of these limits are exceeded, device functionality should not be assumed, damage may occur and reliability may be affected.

1. Current is limited by bondwire configuration.
2. Starting $T_J = 25^\circ\text{C}$, $L = 0.4$ mH, $I_{AS} = 64$ A, $V_{DD} = 40$ V during inductor charging and $V_{DD} = 0$ V during time in avalanche.
3. $R_{\theta JA}$ is the sum of the junction-to-case and case-to-ambient thermal resistance, where the case thermal reference is defined as the solder mounting surface of the drain pins. $R_{\theta JC}$ is guaranteed by design, while $R_{\theta JA}$ is determined by the board design. The maximum rating presented here is based on mounting on a 1 in² pad of 2oz copper.

MARKING DIAGRAM

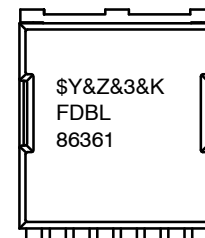

$\$Y$ = ON Semiconductor Logo
 $\&Z$ = Assembly Plant Code
 $\&3$ = Numeric Date Code
 $\&K$ = Lot Code
 FDBL86361 = Specific Device Code

ORDERING INFORMATION

Device	Top Mark	Package	Shipping [†]
FDBL86361 -F085	FDBL86361	H-PSOF8L	2000 Units/ Tape&Reel

*For additional information on our Pb-Free strategy and soldering details, please download the ON Semiconductor Soldering and Mounting Techniques Reference Manual, SOLDERRM/D.

FDBL86361–F085

ELECTRICAL CHARACTERISTICS (T_J = 25°C unless otherwise noted)

Symbol	Parameter	Test Conditions	Min.	Typ.	Max.	Unit
--------	-----------	-----------------	------	------	------	------

OFF CHARACTERISTICS

B _V DSS	Drain-to-Source Breakdown Voltage	I _D = 250 μA, V _{GS} = 0 V	80	–	–	V	
I _{DSS}	Drain-to-Source Leakage Current	V _{DS} = 80 V, V _{GS} = 0 V	T _J = 25°C	–	–	1	μA
			T _J = 175°C (Note 4)	–	–	1	mA
I _{GSS}	Gate-to-Source Leakage Current	V _{GS} = ±20 V	–	–	±100	nA	

ON CHARACTERISTICS

V _{GS(th)}	Gate to Source Threshold Voltage	V _{GS} = V _{DS} , I _D = 250 μA	2.0	3.0	4.0	V	
R _{DS(on)}	Drain to Source on Resistance	I _D = 80 A, V _{GS} = 10 V	T _J = 25°C	–	1.1	1.4	mΩ
			T _J = 175°C (Note 4)	–	2.4	3.1	mΩ

DYNAMIC CHARACTERISTICS

C _{iss}	Input Capacitance	V _{DS} = 40 V, V _{GS} = 0 V, f = 1 MHz	–	12800	–	pF
C _{oss}	Output Capacitance		–	1925	–	pF
C _{rss}	Reverse Transfer Capacitance		–	139	–	pF
R _g	Gate Resistance	f = 1 MHz	–	2.7	–	Ω
Q _{g(toT)}	Total Gate Charge at 10 V	V _{GS} = 0 to 10 V V _{GS} = 0 to 2 V V _{DD} = 64 V I _D = 80 A	–	172	188	nC
Q _{g(th)}	Threshold Gate Charge		–	23	27	nC
Q _{gs}	Gate-to-Source Gate Charge		–	51	–	nC
Q _{gd}	Gate-to-Drain "Miller" Charge		–	34	–	nC

SWITCHING CHARACTERISTICS

t _{on}	Turn-On Time	V _{DD} = 40 V, I _D = 80 A, V _{GS} = 10 V, R _{GEN} = 6 Ω	–	–	128	ns
t _{d(on)}	Turn-On Delay		–	42	–	ns
t _r	Rise Time		–	73	–	ns
t _{d(off)}	Turn-Off Delay		–	87	–	ns
t _f	Fall Time		–	48	–	ns
t _{off}	Turn-Off Time		–	–	193	ns

DRAIN-SOURCE DIODE CHARACTERISTIC

V _{SD}	Source-to-Drain Diode Voltage	I _{SD} = 80 A, V _{GS} = 0 V	–	–	1.25	V
		I _{SD} = 40 A, V _{GS} = 0 V	–	–	1.2	V
t _{rr}	Reverse-Recovery Time	I _F = 80 A, dI _{SD} /dt = 100 A/μs, V _{DD} = 64 V	–	117	136	ns
Q _{rr}	Reverse-Recovery Charge		–	205	269	nC

Product parametric performance is indicated in the Electrical Characteristics for the listed test conditions, unless otherwise noted. Product performance may not be indicated by the Electrical Characteristics if operated under different conditions.

4. The maximum value is specified by design at T_J = 175°C. Product is not tested to this condition in production.

TYPICAL CHARACTERISTICS

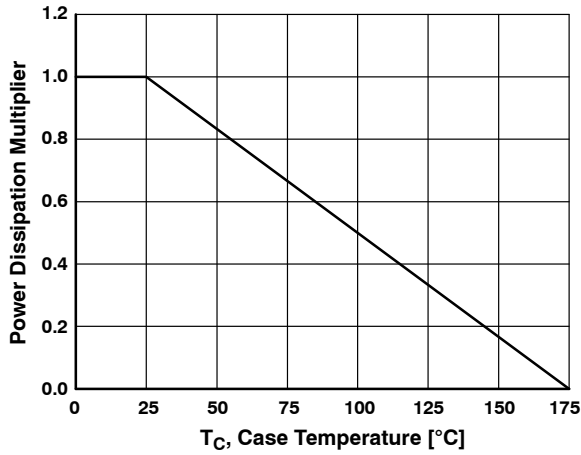

Figure 1. Normalized Power Dissipation vs. Case Temperature

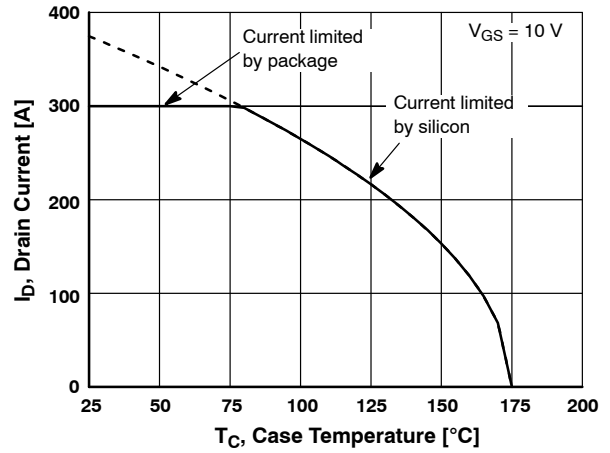

Figure 2. Maximum Continuous Drain Current vs. Case Temperature

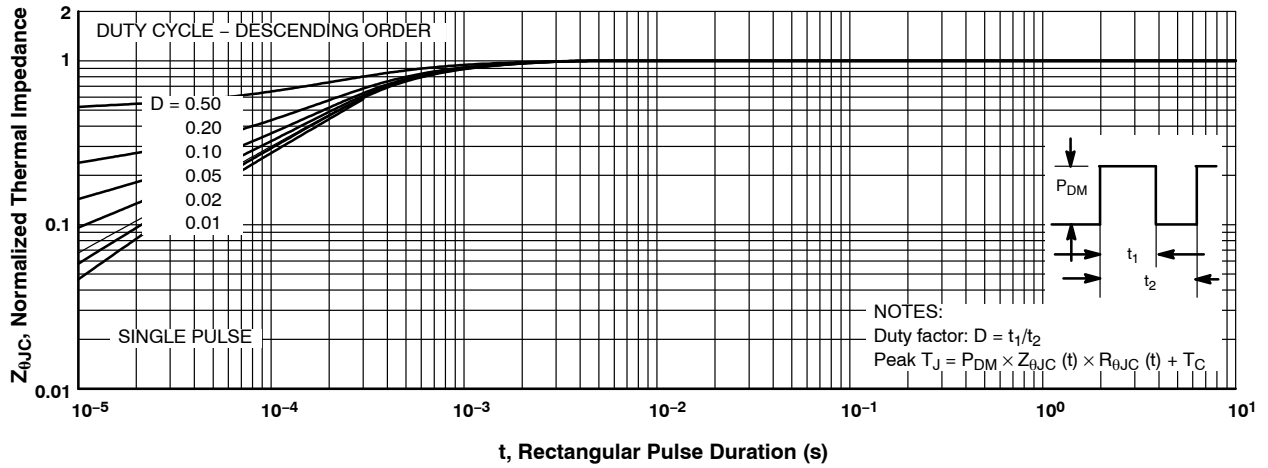

Figure 3. Normalized Maximum Transient Thermal Impedance

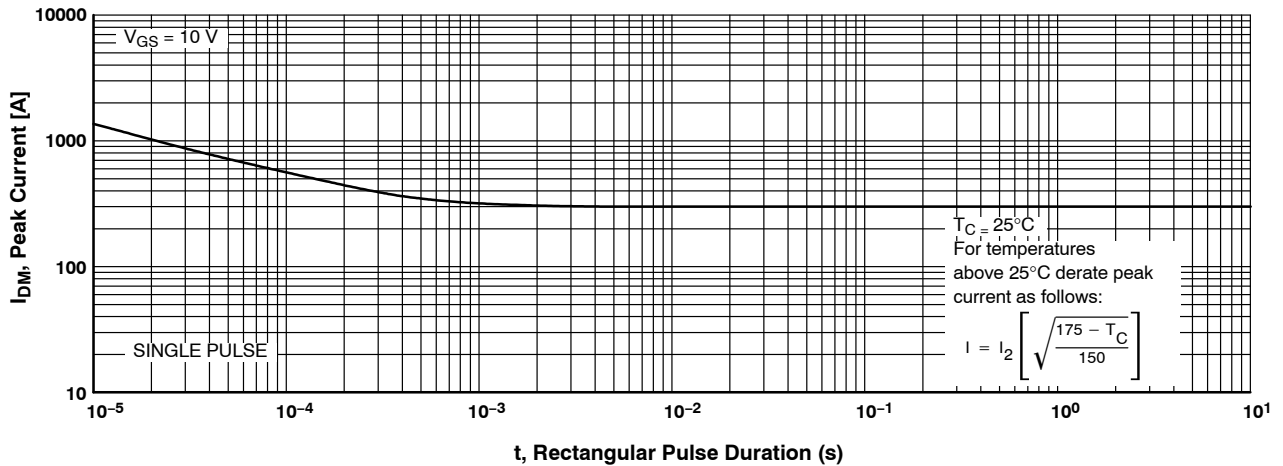

Figure 4. Peak Current Capability

TYPICAL CHARACTERISTICS (continued)

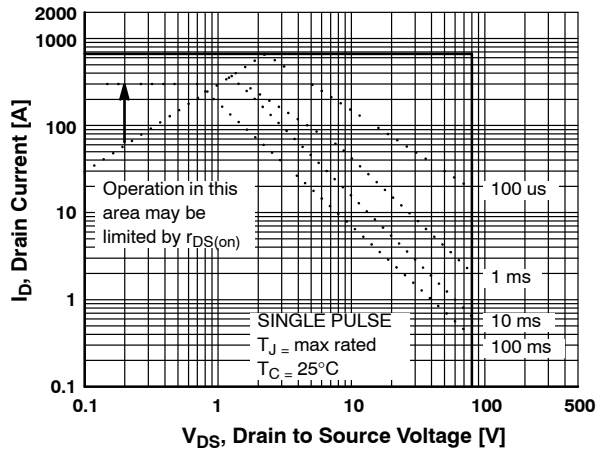
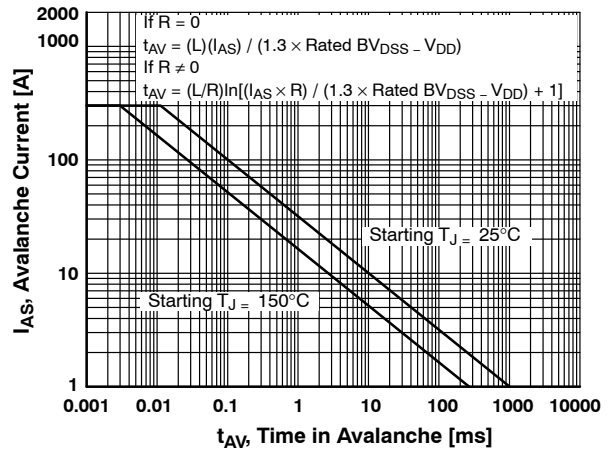

Figure 5. Forward Bias Safe Operating Area



Refer to ON Semiconductor Application Notes AN7514 and AN7515.

Figure 6. Unclamped Inductive Switching Capability

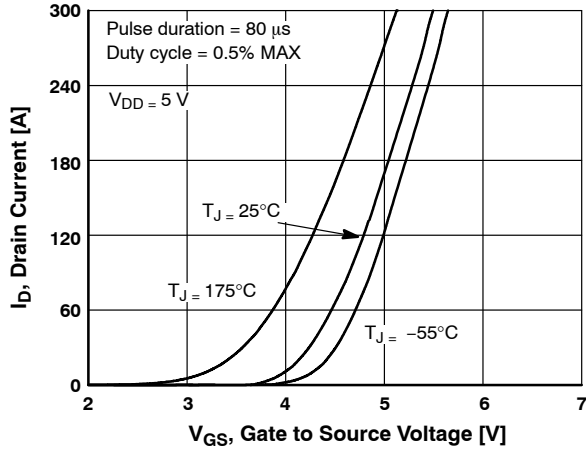

Figure 7. Transfer Characteristics

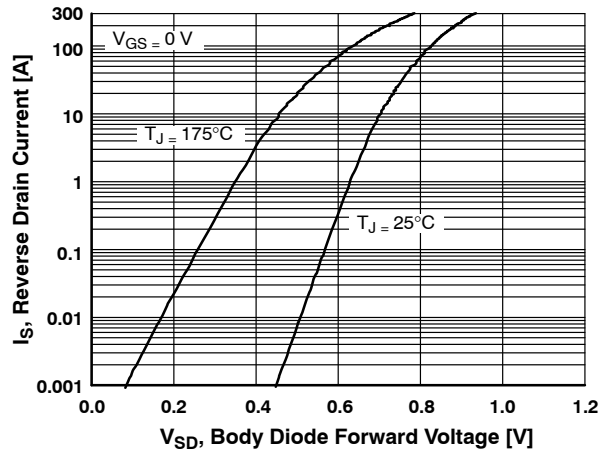

Figure 8. Forward Diode Characteristics

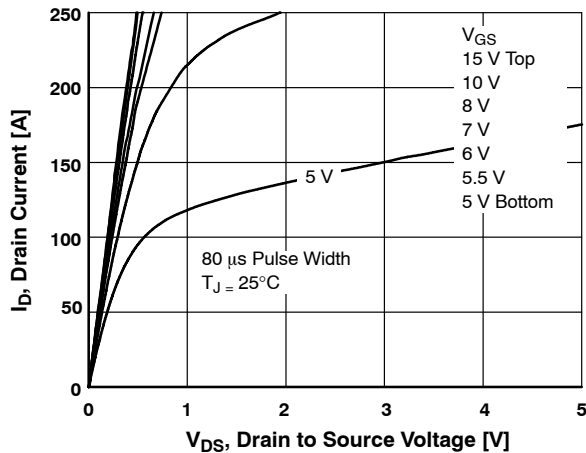

Figure 9. Saturation Characteristics

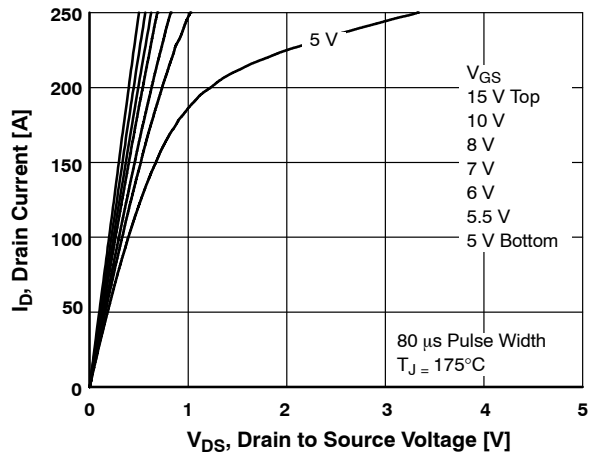

Figure 10. Saturation Characteristics

TYPICAL CHARACTERISTICS (continued)

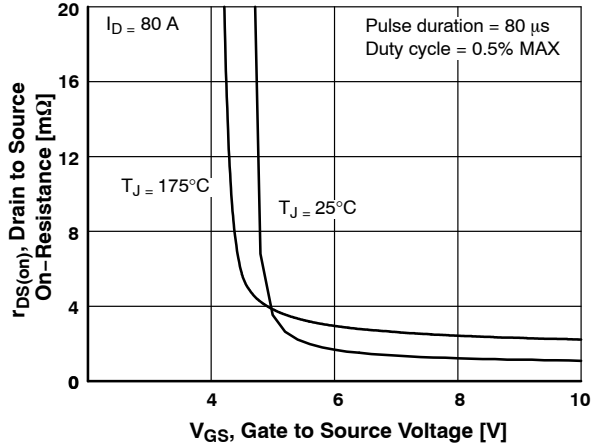

Figure 11. $R_{DS(on)}$ vs. Gate Voltage

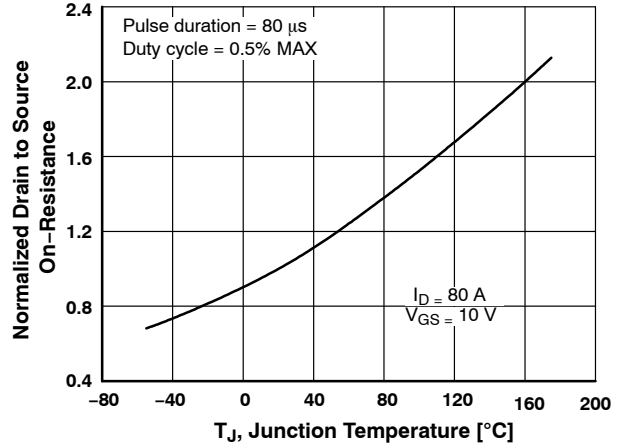

Figure 12. Normalized $R_{DS(on)}$ vs. Junction Temperature

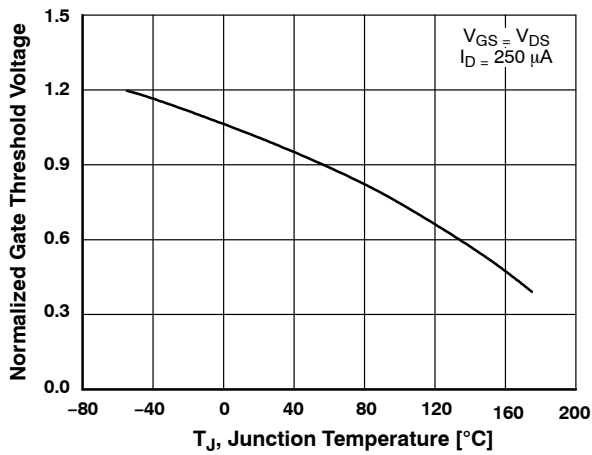

Figure 13. Normalized Gate Threshold Voltage vs. Temperature

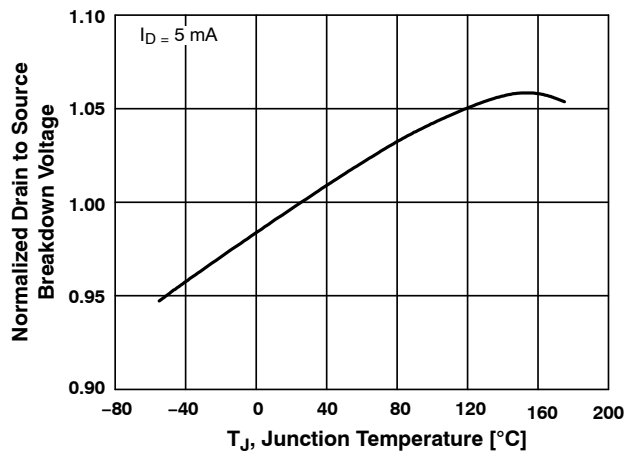

Figure 14. Normalized Drain to Source Breakdown Voltage vs. Junction Temperature

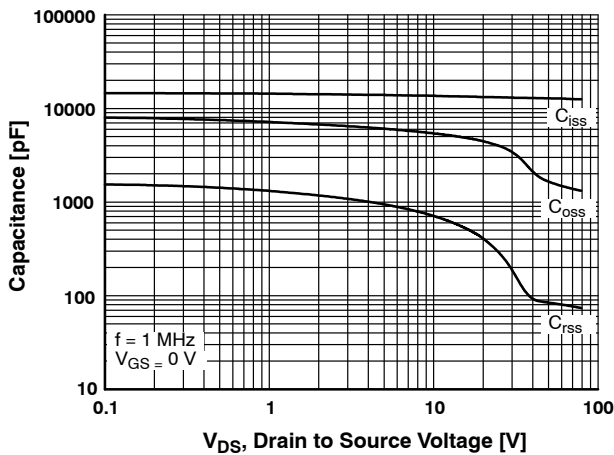

Figure 15. Capacitance vs. Drain to Source Voltage

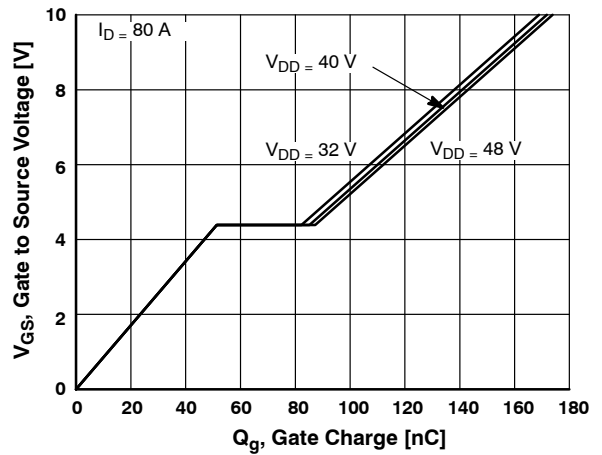

Figure 16. Gate Charge vs. Gate to Source Voltage

POWERTRENCH is registered trademark of Semiconductor Components Industries, LLC (SCILLC) or its subsidiaries in the United States and/or other countries.

MECHANICAL CASE OUTLINE PACKAGE DIMENSIONS

ON Semiconductor®



H-PSOF8L 11.68x9.80 CASE 100CU ISSUE A

DATE 06 JAN 2020

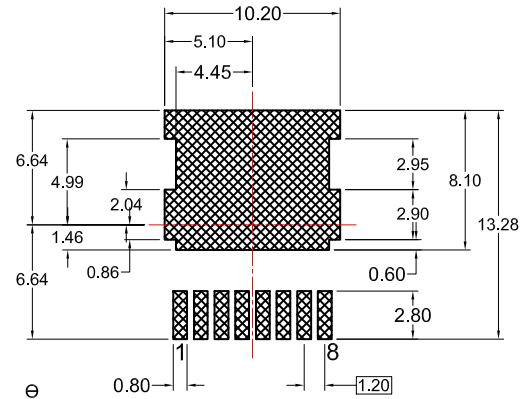
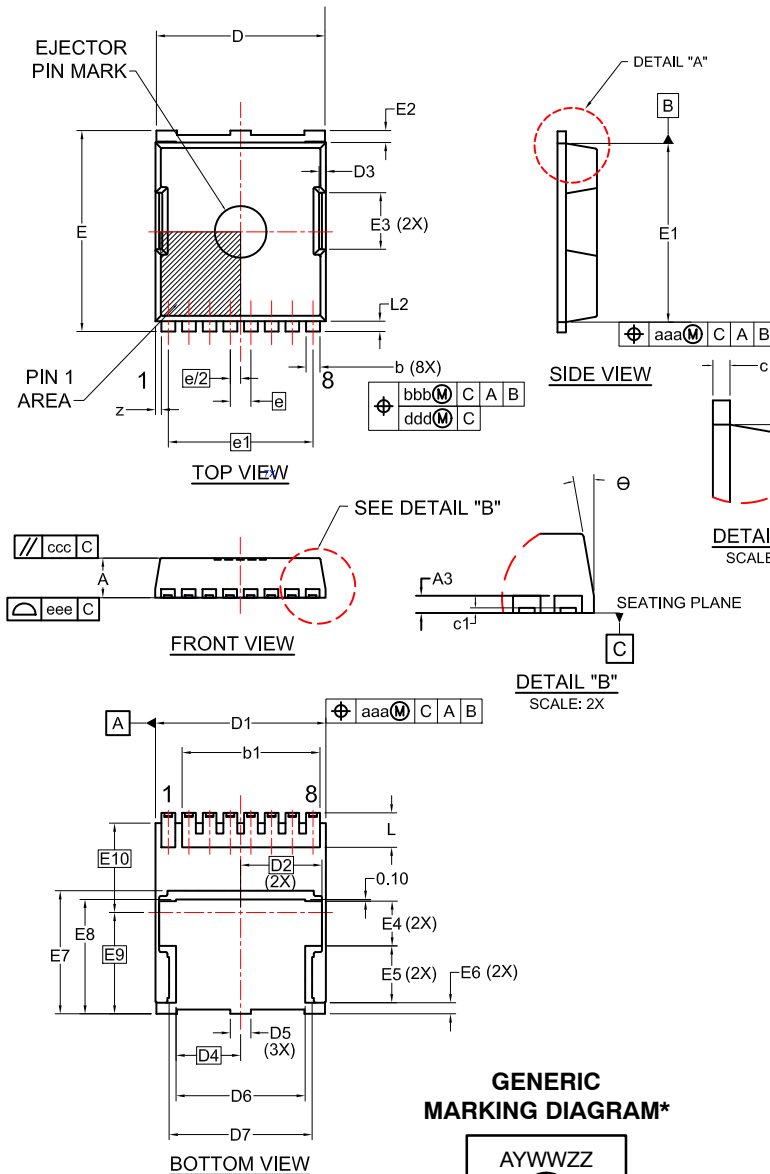

LAND PATTERN RECOMMENDATION
*FOR ADDITIONAL INFORMATION ON OUR PB-FREE STRATEGY AND SOLDERING DETAILS, PLEASE DOWNLOAD THE ON SEMICONDUCTOR SOLDERING AND MOUNTING TECHNIQUES REFERENCE MANUAL, SOLDERRM/D.

- NOTES:
1. PACKAGE STANDARD REFERENCE: JEDEC MO-299, ISSUE A.
 2. DIMENSIONING AND TOLERANCING PER ASME Y14.5M, 2009.
 3. CONTROLLING DIMENSION: MILLIMETERS.
 4. COPLANARITY APPLIES TO THE EXPOSED WELL AS THE TERMINALS.
 5. DIMENSIONS D1 AND E1 DO NOT INCLUDE MOLD FLASH, PROTRUSIONS, OR GATE BURRS.
 6. SEATING PLANE IS DEFINED BY THE TERMINALS. "A1" IS DEFINED AS THE DISTANCE FROM THE SEATING PLANE TO THE LOWEST POINT ON THE PACKAGE BODY.

DIM	MILLIMETERS		
	MIN.	NOM.	MAX.
A	2.20	2.30	2.40
A3	0.40	0.50	0.60
b	0.70	0.80	0.90
b1	8.00 REF		
c	0.40	0.50	0.60
c1	0.10	--	--
D	9.70	9.80	9.90
D1	9.80	9.90	10.00
D2	4.73 BSC		
D3	0.40 REF		
D4	3.75 BSC		
D5	--	1.20	--
D6	7.40	7.50	7.60
D7	(8.30)		
E	11.58	11.68	11.78
E1	10.28	10.38	10.48
E2	0.60	0.70	0.80
E3	3.30 REF		
E4	--	2.60	--

DIM	MILLIMETERS		
	MIN.	NOM.	MAX.
e	1.20 BSC		
e/2	0.60 BSC		
e1	8.40 BSC		
K	1.50	1.57	1.70
L	1.90	2.00	2.10
L2	0.50	0.60	0.70
z	0.35 REF		
θ	0°	--	12°
aaa	0.20		
bbb	0.25		
ccc	0.20		
ddd	0.20		
eee	0.10		
E5	--	3.30	--
E6	--	0.65	--
E7	7.15 REF		
E8	6.55	6.65	6.75
E9	5.89 BSC		
E10	5.19 BSC		

GENERIC MARKING DIAGRAM*

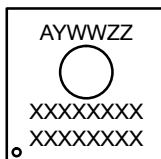

- A = Assembly Location
Y = Year
WW = Work Week
ZZ = Assembly Lot Code
XXXX = Specific Device Code

*This information is generic. Please refer to device data sheet for actual part marking. Pb-Free indicator, "G" or microdot "•", may or may not be present. Some products may not follow the Generic Marking.

DOCUMENT NUMBER:	98AON13813G	Electronic versions are uncontrolled except when accessed directly from the Document Repository. Printed versions are uncontrolled except when stamped "CONTROLLED COPY" in red.
DESCRIPTION:	H-PSOF8L 11.68x9.80	PAGE 1 OF 1

ON Semiconductor and ON are trademarks of Semiconductor Components Industries, LLC dba ON Semiconductor or its subsidiaries in the United States and/or other countries. ON Semiconductor reserves the right to make changes without further notice to any products herein. ON Semiconductor makes no warranty, representation or guarantee regarding the suitability of its products for any particular purpose, nor does ON Semiconductor assume any liability arising out of the application or use of any product or circuit, and specifically disclaims any and all liability, including without limitation special, consequential or incidental damages. ON Semiconductor does not convey any license under its patent rights nor the rights of others.

ON Semiconductor and  are trademarks of Semiconductor Components Industries, LLC dba ON Semiconductor or its subsidiaries in the United States and/or other countries. ON Semiconductor owns the rights to a number of patents, trademarks, copyrights, trade secrets, and other intellectual property. A listing of ON Semiconductor's product/patent coverage may be accessed at www.onsemi.com/site/pdf/Patent-Marking.pdf. ON Semiconductor reserves the right to make changes without further notice to any products herein. ON Semiconductor makes no warranty, representation or guarantee regarding the suitability of its products for any particular purpose, nor does ON Semiconductor assume any liability arising out of the application or use of any product or circuit, and specifically disclaims any and all liability, including without limitation special, consequential or incidental damages. Buyer is responsible for its products and applications using ON Semiconductor products, including compliance with all laws, regulations and safety requirements or standards, regardless of any support or applications information provided by ON Semiconductor. "Typical" parameters which may be provided in ON Semiconductor data sheets and/or specifications can and do vary in different applications and actual performance may vary over time. All operating parameters, including "Typicals" must be validated for each customer application by customer's technical experts. ON Semiconductor does not convey any license under its patent rights nor the rights of others. ON Semiconductor products are not designed, intended, or authorized for use as a critical component in life support systems or any FDA Class 3 medical devices or medical devices with a same or similar classification in a foreign jurisdiction or any devices intended for implantation in the human body. Should Buyer purchase or use ON Semiconductor products for any such unintended or unauthorized application, Buyer shall indemnify and hold ON Semiconductor and its officers, employees, subsidiaries, affiliates, and distributors harmless against all claims, costs, damages, and expenses, and reasonable attorney fees arising out of, directly or indirectly, any claim of personal injury or death associated with such unintended or unauthorized use, even if such claim alleges that ON Semiconductor was negligent regarding the design or manufacture of the part. ON Semiconductor is an Equal Opportunity/Affirmative Action Employer. This literature is subject to all applicable copyright laws and is not for resale in any manner.

PUBLICATION ORDERING INFORMATION

LITERATURE FULFILLMENT:

Email Requests to: orderlit@onsemi.com

ON Semiconductor Website: www.onsemi.com

TECHNICAL SUPPORT

North American Technical Support:
Voice Mail: 1 800-282-9855 Toll Free USA/Canada
Phone: 011 421 33 790 2910

Europe, Middle East and Africa Technical Support:
Phone: 00421 33 790 2910

For additional information, please contact your local Sales Representative