

# FGPF7N60LSD

## 600V, 7A Low Saturation IGBT CO-PAK

### Features

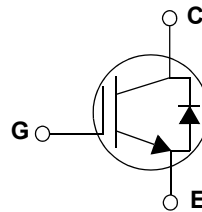
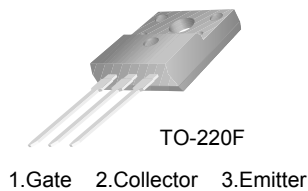
- Low saturation voltage :  $V_{CE(sat)} = 1.4 \text{ V @ } I_C = 7 \text{ A}$
- High input impedance
- CO-PAK, IGBT with FRD :  $t_{rr} = 50 \text{ ns (typ.)}$

### Description

Fairchild's Insulated Gate Bipolar Transistors (IGBTs) provides very low conduction and switching losses. The device is designed for Lamp applications where very low On-Voltage Drop is a required feature.

### Applications

Lamp applications (Hallogen Dimmer)



### Absolute Maximum Ratings

Symbol	Description	FGPF7N60LSD	Units
$V_{CES}$	Collector-Emitter Voltage	600	V
$V_{GES}$	Gate-Emitter Voltage	$\pm 20$	V
$I_C$	Collector Current	@ $T_C = 25^\circ\text{C}$	14
	Collector Current	@ $T_C = 100^\circ\text{C}$	7
$I_{CM(1)}$	Pulsed Collector Current	21	A
$I_F$	Diode Continuous Forward Current	@ $T_C = 100^\circ\text{C}$	12
$I_{FM}$	Diode Maximum Forward Current	60	A
$P_D$	Maximum Power Dissipation	@ $T_C = 25^\circ\text{C}$	45
	Maximum Power Dissipation	@ $T_C = 100^\circ\text{C}$	18
$T_J$	Operating Junction Temperature	-55 to +150	$^\circ\text{C}$
$T_{stg}$	Storage Temperature Range	-55 to +150	$^\circ\text{C}$
$T_L$	Maximum Lead Temp. for Soldering Purposes, 1/8" from Case for 5 Seconds	300	$^\circ\text{C}$

**Notes :**

(1) Repetitive rating : Pulse width limited by max. junction temperature

### Thermal Characteristics

Symbol	Parameter	Typ.	Max.	Units
$R_{\theta JC}$ (IGBT)	Thermal Resistance, Junction-to-Case	--	2.8	$^\circ\text{C/W}$
$R_{\theta JC}$ (DIODE)	Thermal Resistance, Junction-to-Case	--	4.5	$^\circ\text{C/W}$
$R_{\theta JA}$	Thermal Resistance, Junction-to-Ambient (PCB Mount) (2)	--	62.5	$^\circ\text{C/W}$

**Notes :**

(2) Mounted on 1" square PCB (FR4 or G-10 Material)

## Package Marking and Ordering Information

Device Marking	Device	Package	Packaging Type	Qty per Tube	Max Qty per Box
FGPF7N60LSD	FGPF7N60LSDTU	TO-220F	Rail /Tube	50ea	1,000ea

## Electrical Characteristics of the IGBT T<sub>C</sub> = 25°C unless otherwise noted

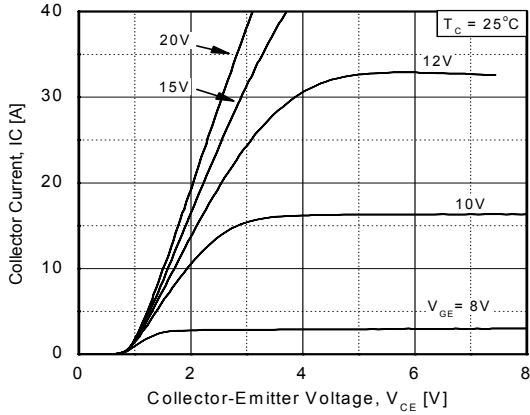
Symbol	Parameter	Test Conditions	Min.	Typ.	Max.	Units
<b>Off Characteristics</b>						
$BV_{CES}$	Collector-Emitter Breakdown Voltage	$V_{GE} = 0V, I_C = 250\mu A$	600	--	--	V
$\frac{\Delta BV_{CES}}{\Delta T_J}$	Temperature Coefficient of Breakdown Voltage	$V_{GE} = 0V, I_C = 1mA$	--	0.6	--	V/°C
$I_{CES}$	Collector Cut-Off Current	$V_{CE} = V_{CES}, V_{GE} = 0V$	--	--	250	$\mu A$
$I_{GES}$	G-E Leakage Current	$V_{GE} = V_{GES}, V_{CE} = 0V$	--	--	$\pm 100$	nA
<b>On Characteristics</b>						
$V_{GE(th)}$	G-E Threshold Voltage	$I_C = 7mA, V_{CE} = V_{GE}$	5.0	6.5	8.0	V
$V_{CE(sat)}$	Collector to Emitter Saturation Voltage	$I_C = 7A, V_{GE} = 15V$	--	1.4	2.0	V
		$I_C = 7A, V_{GE} = 15V, T_C = 125^\circ C$	--	1.47	--	V
		$I_C = 14A, V_{GE} = 15V$	--	1.85	--	V
<b>Dynamic Characteristics</b>						
$C_{ies}$	Input Capacitance	$V_{CE} = 30V, V_{GE} = 0V, f = 1MHz$	--	510	--	pF
$C_{oes}$	Output Capacitance		--	55	--	pF
$C_{res}$	Reverse Transfer Capacitance		--	15	--	pF
<b>Switching Characteristics</b>						
$t_{d(on)}$	Turn-On Delay Time	$V_{CC} = 300V, I_C = 7A, R_G = 470\Omega, V_{GE} = 15V, \text{Inductive Load}, T_C = 25^\circ C$	--	120	--	ns
$t_r$	Rise Time		--	44	--	ns
$t_{d(off)}$	Turn-Off Delay Time		--	410	535	ns
$t_f$	Fall Time		--	2320	3480	ns
$E_{on}$	Turn-On Switching Loss		--	0.27	--	$\mu J$
$E_{off}$	Turn-Off Switching Loss		--	3.8	--	mJ
$E_{ts}$	Total Switching Loss		--	4.07	6.1	mJ
$t_{d(on)}$	Turn-On Delay Time	$V_{CC} = 300V, I_C = 7A, R_G = 470\Omega, V_{GE} = 15V, \text{Inductive Load}, T_C = 125^\circ C$	--	105	--	ns
$t_r$	Rise Time		--	50	--	ns
$t_{d(off)}$	Turn-Off Delay Time		--	420	--	ns
$t_f$	Fall Time		--	3745	--	ns
$E_{on}$	Turn-On Switching Loss		--	0.22	--	$\mu J$
$E_{off}$	Turn-Off Switching Loss		--	5.94	--	mJ
$E_{ts}$	Total Switching Loss		--	6.16	--	mJ
$Q_g$	Total Gate Charge	$V_{CE} = 300V, I_C = 7A, V_{GE} = 15V$	--	24	36	nC
$Q_{ge}$	Gate-Emitter Charge		--	4	6	nC
$Q_{gc}$	Gate-Collector Charge		--	10	15	nC
$L_e$	Internal Emitter Inductance	Measured 5mm from PKG	--	7.5	--	nH

**Electrical Characteristics of DIODE**  $T_C = 25^\circ\text{C}$  unless otherwise noted

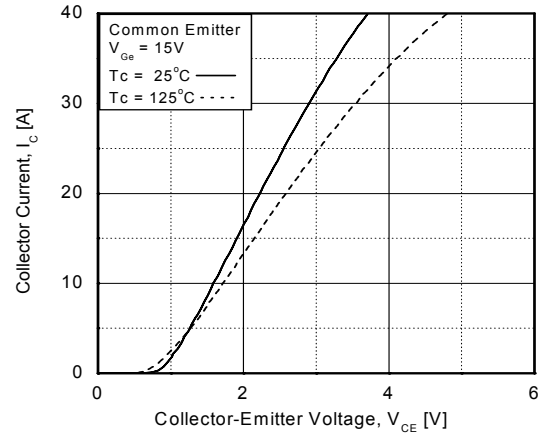
Symbol	Parameter	Test Conditions	Min.	Typ.	Max.	Units	
$V_{FM}$	Diode Forward Voltage	$I_F = 7A$	$T_C = 25^\circ\text{C}$	--	1.65	2.1	V
			$T_C = 100^\circ\text{C}$	--	1.58	--	
$t_{rr}$	Diode Reverse Recovery Time	$I_F = 7A$ $di/dt = 200 A/\mu s$	$T_C = 25^\circ\text{C}$	--	50	65	ns
			$T_C = 100^\circ\text{C}$	--	58	--	
$I_{rr}$	Diode Peak Reverse Recovery Current		$T_C = 25^\circ\text{C}$	--	2.5	3.75	A
			$T_C = 100^\circ\text{C}$	--	3.3	--	
$Q_{rr}$	Diode Reverse Recovery Charge		$T_C = 25^\circ\text{C}$	--	62.5	122	nC
			$T_C = 100^\circ\text{C}$	--	95.7	--	

## Typical Performance Characteristics

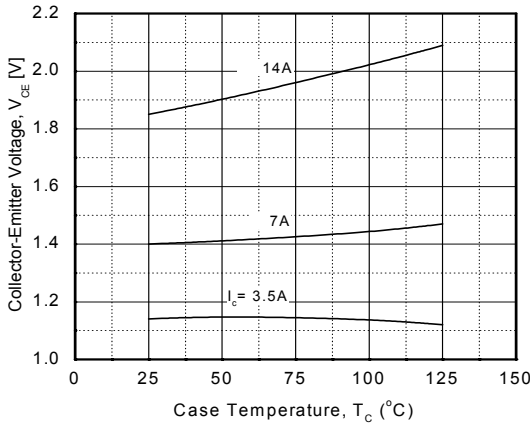
**Figure 1. Typical Output Characteristics**



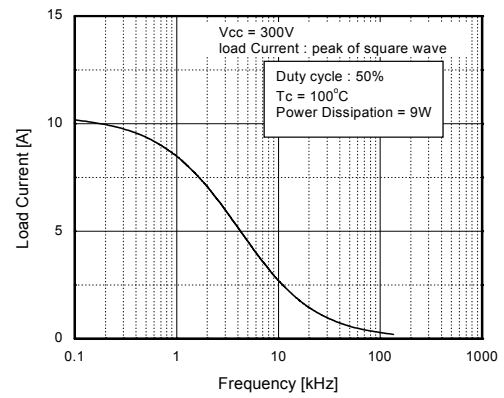
**Figure 2. Typical Saturation Voltage Characteristics**



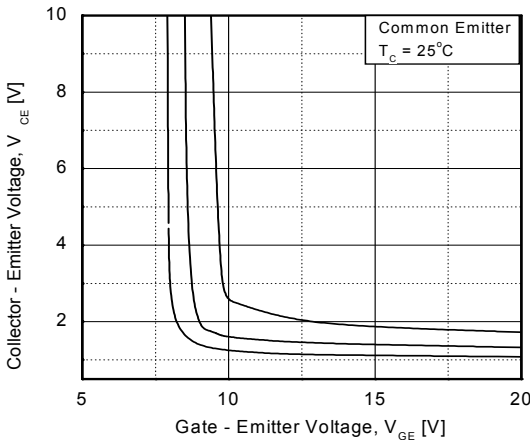
**Figure 3. Typical Saturation Voltage Characteristics**



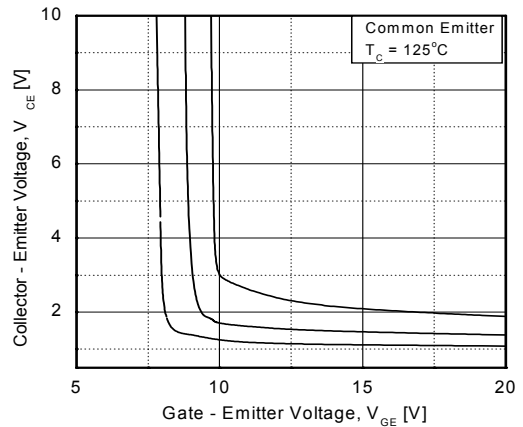
**Figure 4. Load Current vs Frequency**



**Figure 5. Saturation Voltage vs. Vge**

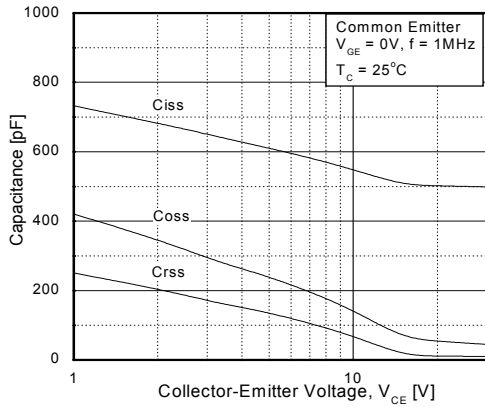


**Figure 6. Saturation Voltage vs. Vge**

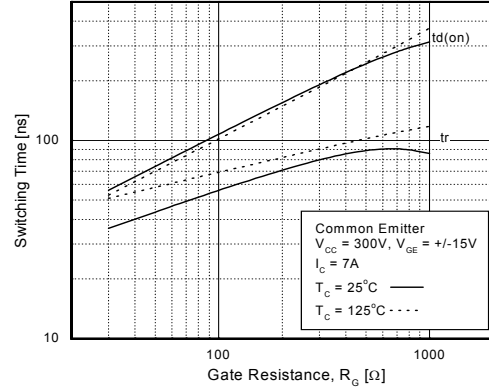


**Typical Performance Characteristics** (Continued)

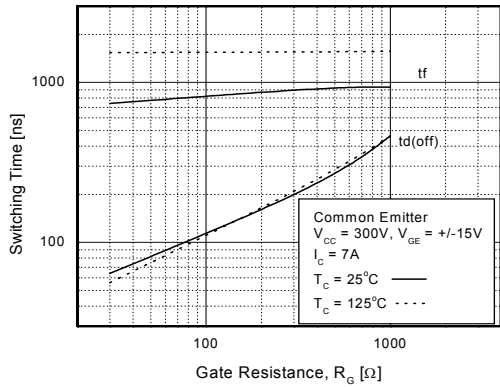
**Figure 7. Capacitance Characteristics**



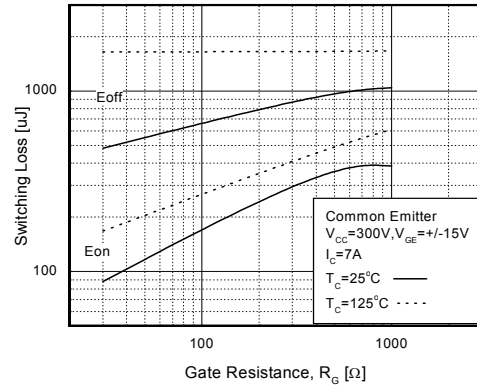
**Figure 8. Turn-On Characteristics vs. Gate Resistance**



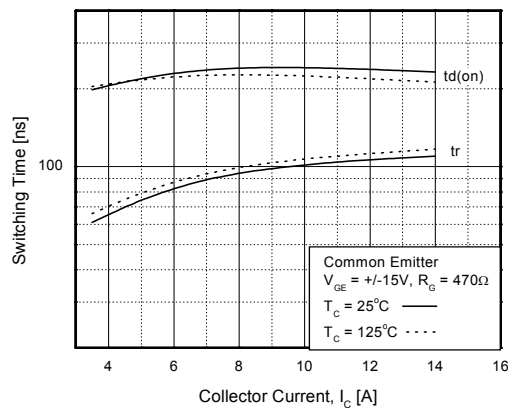
**Figure 9. Turn-Off Characteristics vs. Gate Resistance**



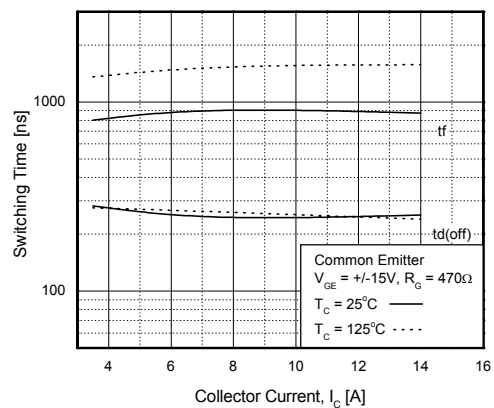
**Figure 10. Switching Loss vs. Gate Resistance**



**Figure 11. Turn-On Characteristics vs. Collector Current**

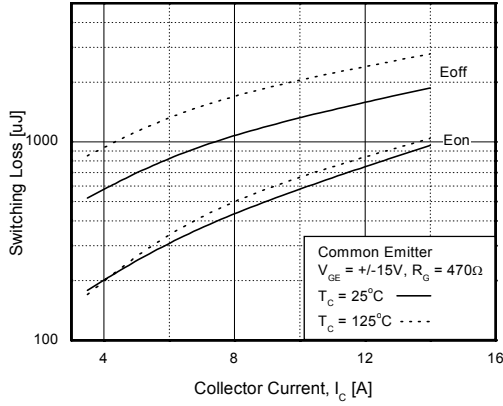


**Figure 12. Turn-Off Characteristics vs. Collector Current**

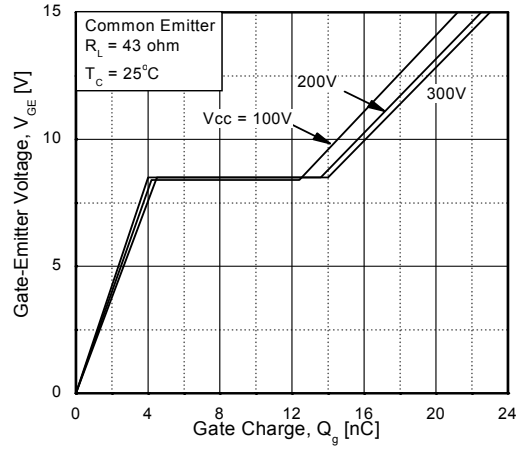


**Typical Performance Characteristics** (Continued)

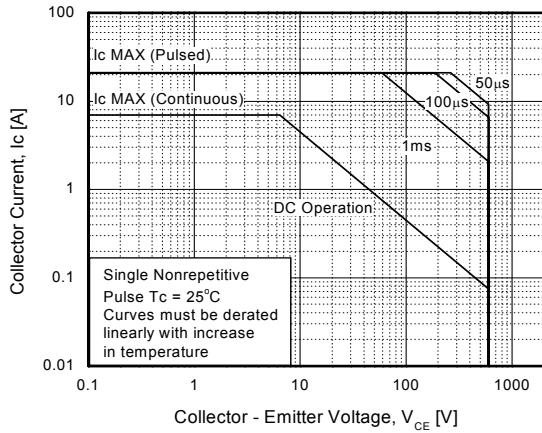
**Figure 13. Switching Loss vs. Collector Current**



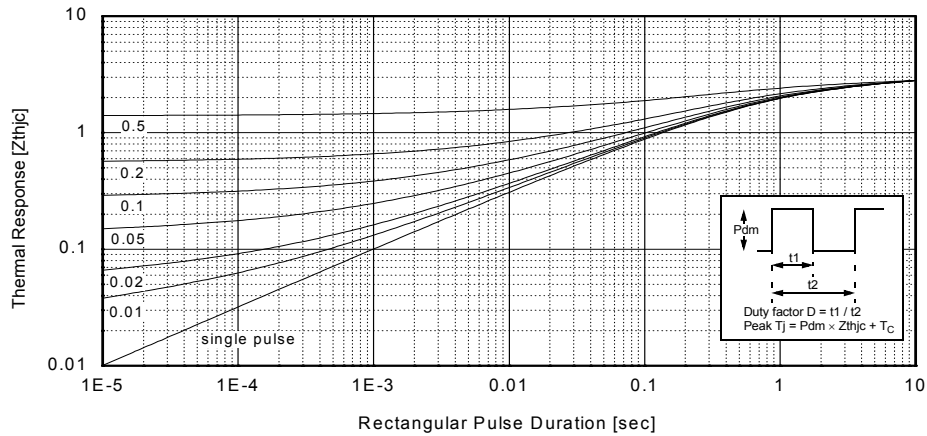
**Figure 14. Gate Charge Characteristics**



**Figure 15. SOA Characteristics**

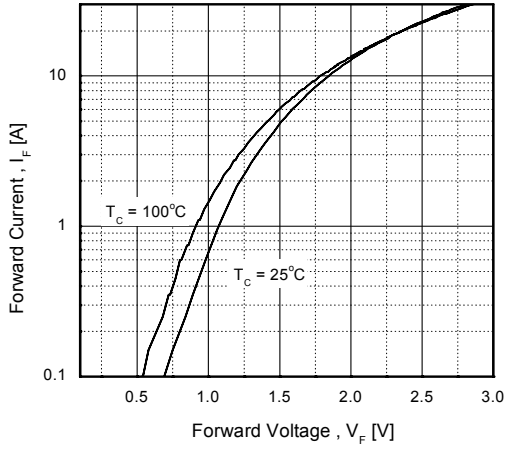


**Figure 16. Transient Thermal Impedance of IGBT**

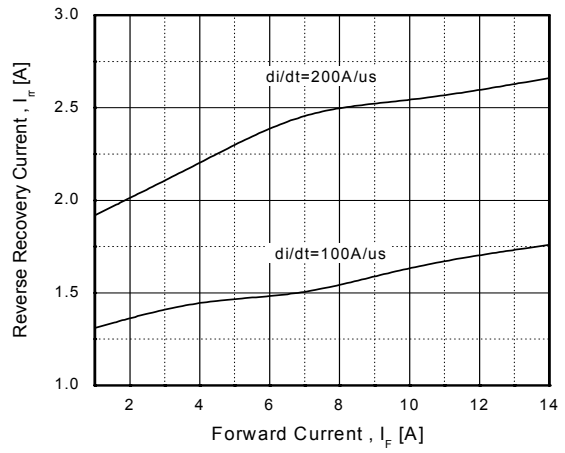


**Typical Performance Characteristics** (Continued)

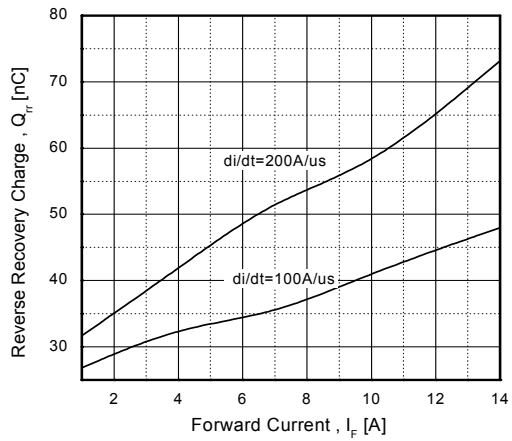
**Figure 17. Forward Voltage Characteristics**



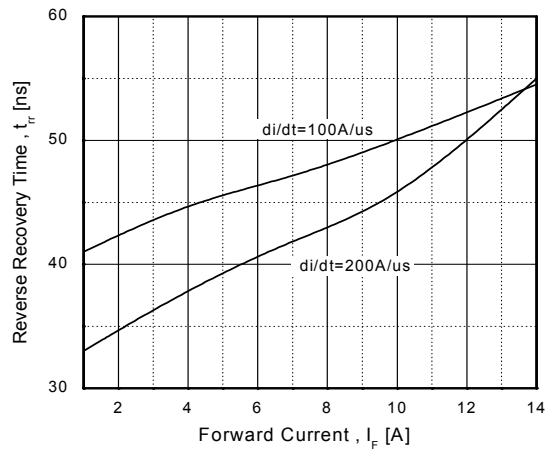
**Figure 18. Reverse Recovery Current**



**Figure 19. Stored Charge**

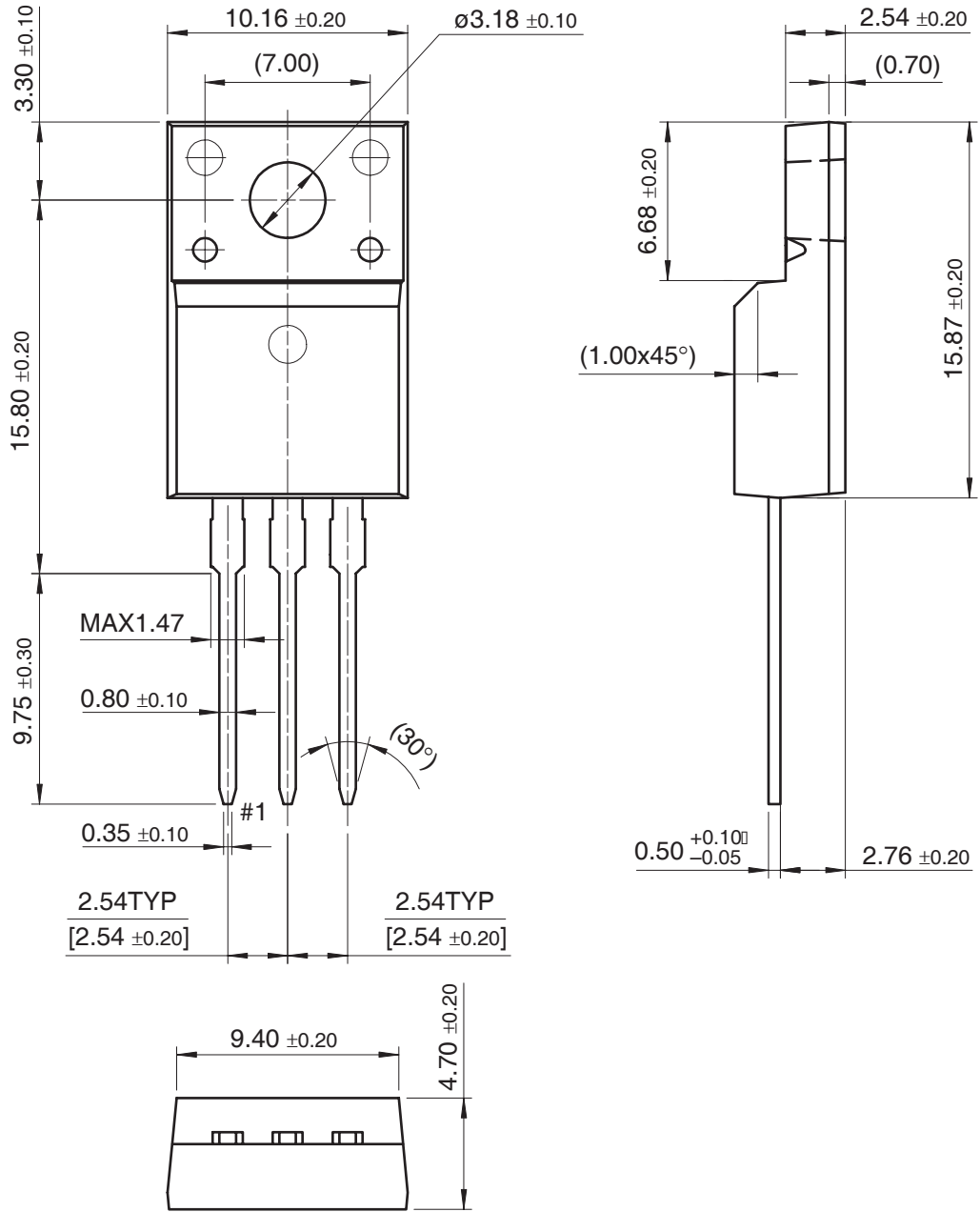


**Figure 20. Reverse Recovery Time**



Mechanical Dimensions

TO-220F



Dimensions in Millimeters



## TRADEMARKS

The following are registered and unregistered trademarks Fairchild Semiconductor owns or is authorized to use and is not intended to be an exhaustive list of all such trademarks.

ACEx™	FAST®	ISOPLANAR™	PowerSaver™	SuperSOT™-6
ActiveArray™	FASTr™	LittleFET™	PowerTrench®	SuperSOT™-8
Bottomless™	FPS™	MICROCOUPLER™	QFET®	SyncFET™
Build it Now™	FRFET™	MicroFET™	QS™	TinyLogic®
CoolFET™	GlobalOptoisolator™	MicroPak™	QT Optoelectronics™	TINYOPTO™
CROSSVOL™	GTO™	MICROWIRE™	Quiet Series™	TruTranslation™
DOMET™	HiSeC™	MSX™	RapidConfigure™	UHC™
EcoSPARK™	I <sup>2</sup> C™	MSXPro™	RapidConnect™	UltraFET®
E <sup>2</sup> CMOS™	i-Lo™	OCX™	µSerDes™	UniFET™
EnSigna™	ImpliedDisconnect™	OCXPro™	ScalarPump™	VCX™
FACT™	IntelliMAX™	OPTOLOGIC®	SILENT SWITCHER®	Wire™
FACT Quiet Series™		OPTOPLANAR™	SMART START™	
		PACMAN™	SPM™	
Across the board. Around the world.™		POP™	Stealth™	
The Power Franchise®		Power247™	SuperFET™	
Programmable Active Droop™		PowerEdge™	SuperSOT™-3	

## DISCLAIMER

FAIRCHILD SEMICONDUCTOR RESERVES THE RIGHT TO MAKE CHANGES WITHOUT FURTHER NOTICE TO ANY PRODUCTS HEREIN TO IMPROVE RELIABILITY, FUNCTION OR DESIGN. FAIRCHILD DOES NOT ASSUME ANY LIABILITY ARISING OUT OF THE APPLICATION OR USE OF ANY PRODUCT OR CIRCUIT DESCRIBED HEREIN; NEITHER DOES IT CONVEY ANY LICENSE UNDER ITS PATENT RIGHTS, NOR THE RIGHTS OF OTHERS.

## LIFE SUPPORT POLICY

FAIRCHILD'S PRODUCTS ARE NOT AUTHORIZED FOR USE AS CRITICAL COMPONENTS IN LIFE SUPPORT DEVICES OR SYSTEMS WITHOUT THE EXPRESS WRITTEN APPROVAL OF FAIRCHILD SEMICONDUCTOR CORPORATION.

As used herein:

1. Life support devices or systems are devices or systems which, (a) are intended for surgical implant into the body, or (b) support or sustain life, or (c) whose failure to perform when properly used in accordance with instructions for use provided in the labeling, can be reasonably expected to result in significant injury to the user.
2. A critical component is any component of a life support device or system whose failure to perform can be reasonably expected to cause the failure of the life support device or system, or to affect its safety or effectiveness.

## PRODUCT STATUS DEFINITIONS

### Definition of Terms

Datasheet Identification	Product Status	Definition
Advance Information	Formative or In Design	This datasheet contains the design specifications for product development. Specifications may change in any manner without notice.
Preliminary	First Production	This datasheet contains preliminary data, and supplementary data will be published at a later date. Fairchild Semiconductor reserves the right to make changes at any time without notice in order to improve design.
No Identification Needed	Full Production	This datasheet contains final specifications. Fairchild Semiconductor reserves the right to make changes at any time without notice in order to improve design.
Obsolete	Not In Production	This datasheet contains specifications on a product that has been discontinued by Fairchild semiconductor. The datasheet is printed for reference information only.

Rev. 117