

# J201 - J202 / MMBFJ201 - MMBFJ203 N-Channel General Purpose Amplifier

- This device is designed primarily for low level audio and general purpose applications with high impedance signal sources.
- Sourced from Process 52.

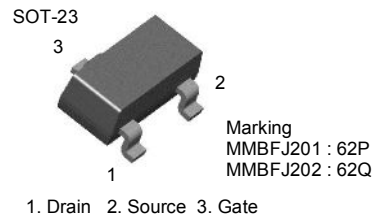
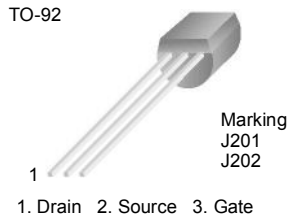

## Absolute Maximum Ratings\* $T_a=25^\circ\text{C}$ unless otherwise noted

Symbol	Parameter	Value	Units
$V_{DG}$	Drain-Gate Voltage	40	V
$V_{GS}$	Gate-Source Voltage	-40	V
$I_{GF}$	Forward Gate Current	50	mA
$T_J, T_{STG}$	Operating and Storage Junction Temperature Range	-55 ~ 150	$^\circ\text{C}$

\* These ratings are limiting values above which the serviceability of any semiconductor device may be impaired.

**NOTES:**

- 1) These ratings are based on a maximum junction temperature of  $150^\circ\text{C}$ .
- 2) These are steady state limits. The factory should be consulted on applications involving pulsed or low duty cycle operations.

## Thermal Characteristics\* $T_a=25^\circ\text{C}$ unless otherwise noted

Symbol	Parameter	Value		Units
		J201 - J202	MMBFJ201 - MMBFJ203	
$P_D$	Total Device Dissipation	625	350	W
	Derate above $25^\circ\text{C}$	5.0	2.8	mW/ $^\circ\text{C}$
$R_{\theta JC}$	Thermal Resistance, Junction to Case	125		$^\circ\text{C}/\text{W}$
$R_{\theta JA}$	Thermal Resistance, Junction to Ambient	357	556	$^\circ\text{C}/\text{W}$

\* Device mounted on FR-4 PCB  $1.6'' \times 1.6'' \times 0.06''$

**Electrical Characteristics \***  $T_C = 25^\circ\text{C}$  unless otherwise noted

Symbol	Parameter	Conditions	Min.	Max	Units	
<b>Off Characteristics</b>						
$V_{(BR)GSS}$	Gate-Source Breakdwon Voltage	$I_G = -1\mu\text{A}, V_{DS} = 0$	-40		V	
$I_{GSS}$	Gate Reverse Current	$V_{GS} = -20\text{V}, V_{DS} = 0$		-100	pA	
$V_{GS(off)}$	Gate-Source Cutoff Voltage	$V_{DS} = 20\text{V}, I_D = 10\text{nA}$	201	-0.3	-1.5	V
			202	-0.8	-4	
			203	-2	-10	
<b>On Characteristics</b>						
$I_{DSS}$	Zero-Gate Voltage Drain Current *	$V_{DS} = 20\text{V}, I_{GS} = 0$	201	0.2	1.0	mA
			202	0.9	4.5	
			203	4	20	
<b>Small Signal Characteristics</b>						
$y_{FS}$	Forward Transfer Admittance	$V_{DS} = 20\text{V}, f = 1.0\text{kHz}$	201	500		$\mu\text{mhos}$
			202	1000		
			203	1500		

\* Pulse Test: Pulse Width  $\leq 300\text{ms}$ , Duty Cycle  $\leq 2.0\%$

# Typical Characteristics

Parameter Interactions

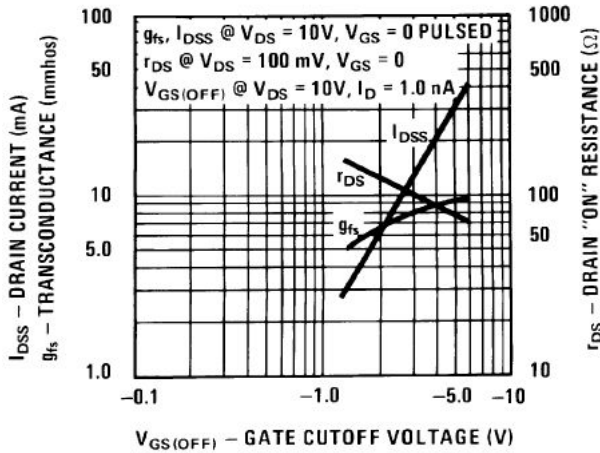

Common Drain-Source

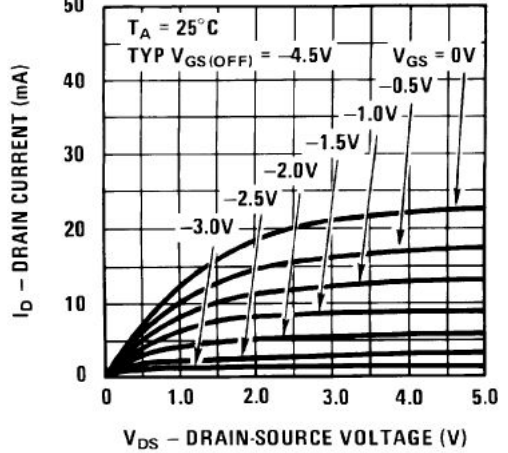

Transfer Characteristics

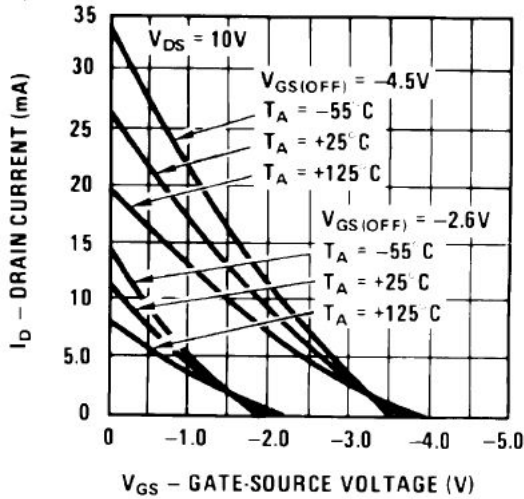

Transfer Characteristics

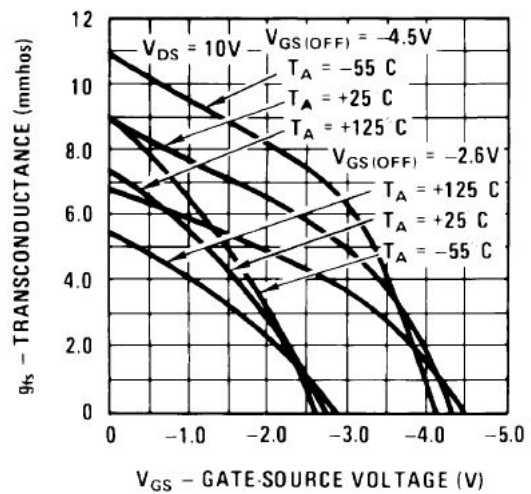

Leakage Current vs. Voltage

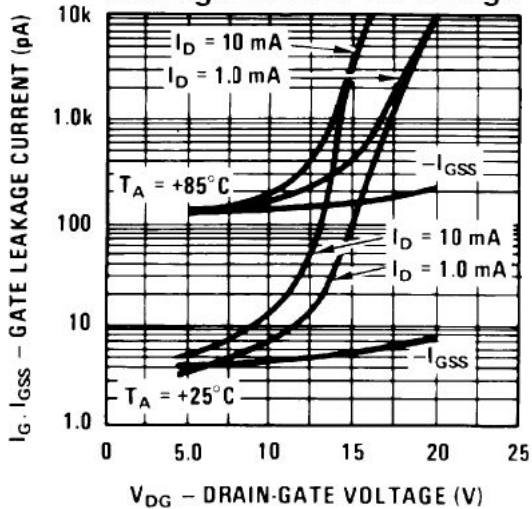

Noise Voltage vs. Frequency

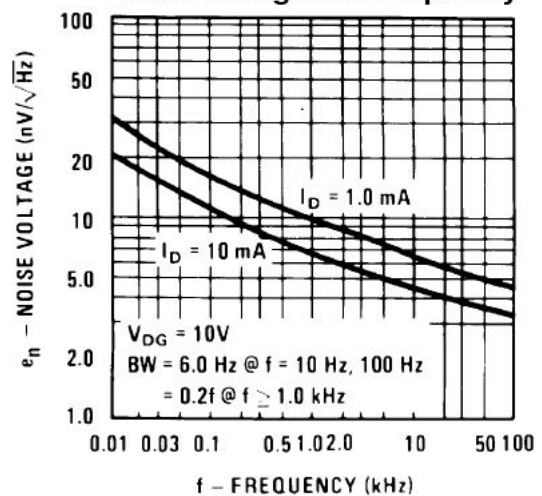

Typical Characteristics (Continued)

Transconductance vs. Drain Current

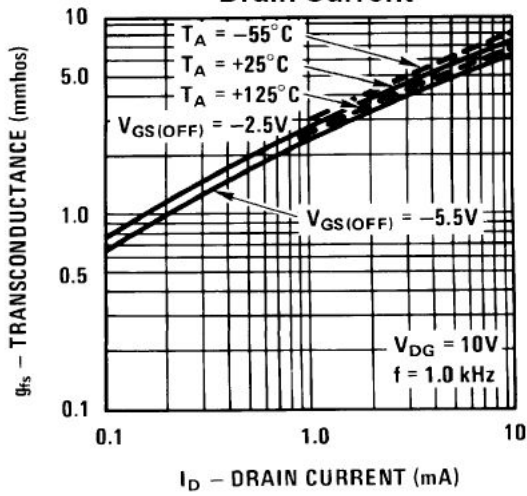

Output Conductance vs. Drain Current

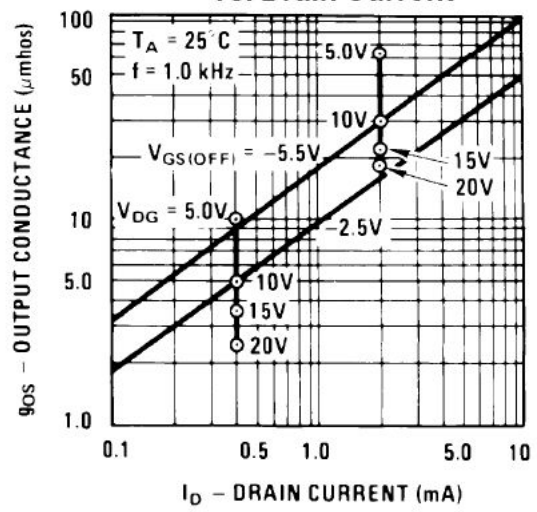

Capacitance vs. Voltage

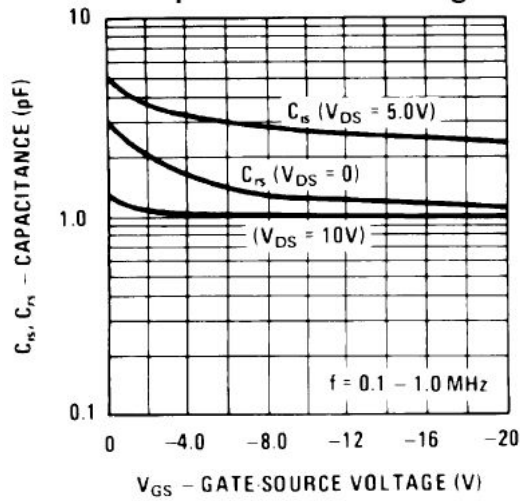

Typical Characteristics (Continued)

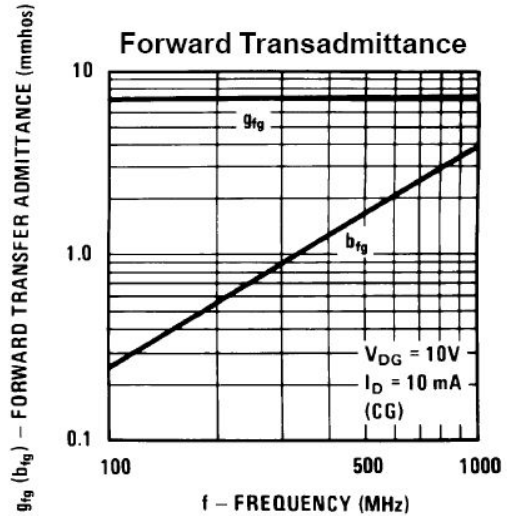
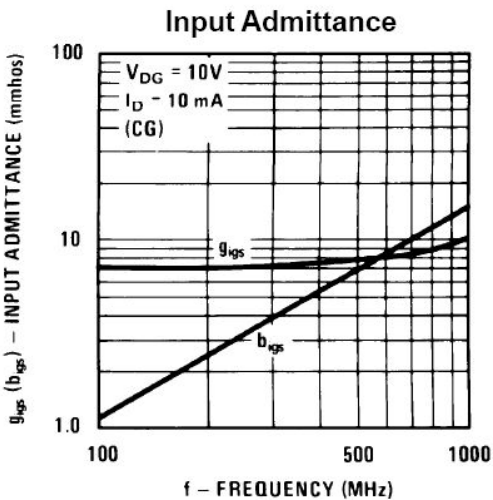
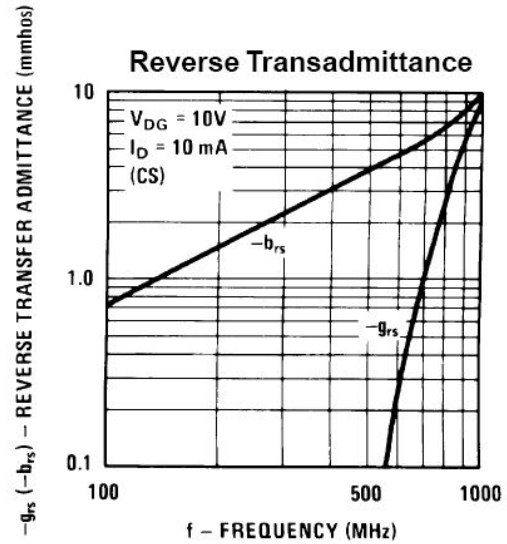
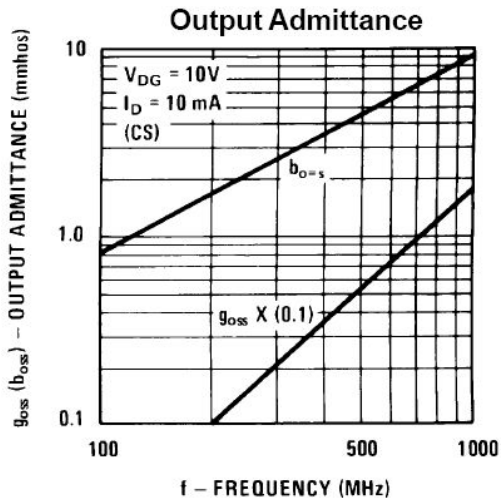
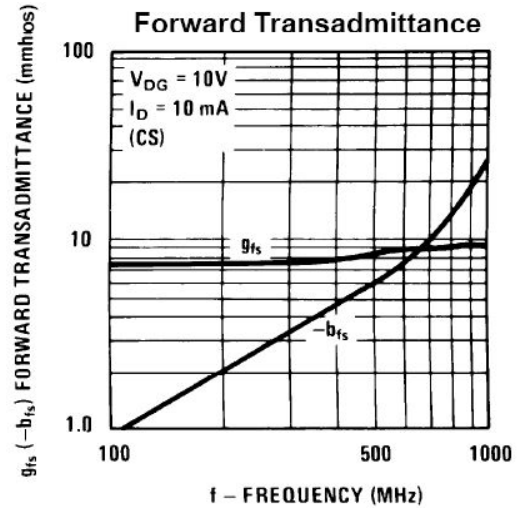
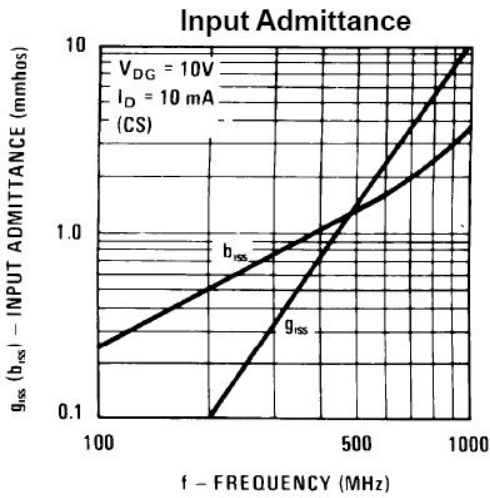

# Mechanical Dimensions

## TO-92

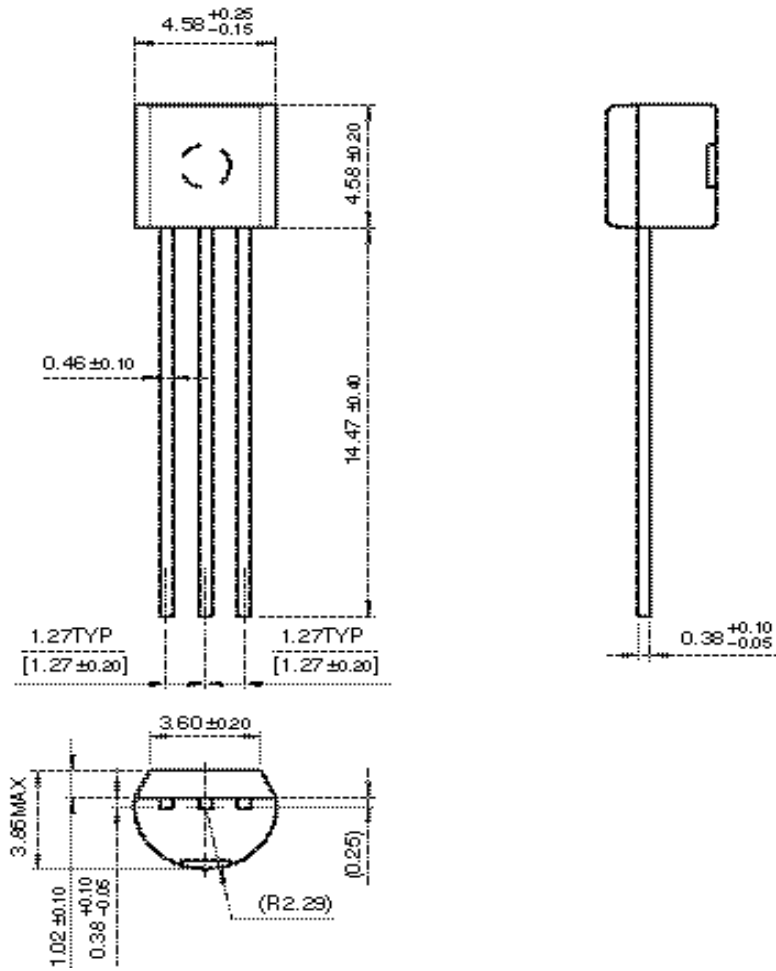

Mechanical Dimensions

SOT-23

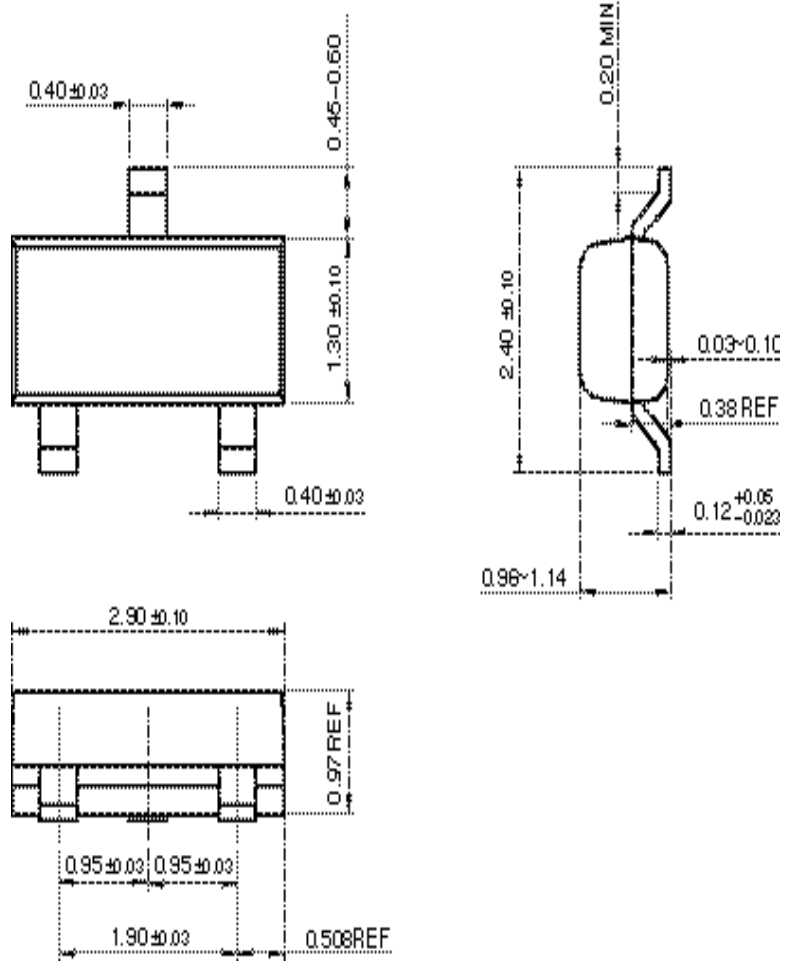



Dimensions in Millimeters



## TRADEMARKS

The following are registered and unregistered trademarks and service marks Fairchild Semiconductor owns or is authorized to use and is not intended to be an exhaustive list of all such trademarks.

ACEX®	Green FPS™	Power247®	SuperSOT™-8
Build it Now™	Green FPS™ e-Series™	POWEREDGE®	SyncFET™
CorePLUS™	GTO™	Power-SPM™	The Power Franchise®
CROSSVOLT™	i-Lo™	PowerTrench®	
CTL™	IntelliMAX™	Programmable Active Droop™	TinyBoost™
Current Transfer Logic™	ISOPLANAR™	QFET®	TinyBuck™
EcoSPARK®	MegaBuck™	QS™	TinyLogic®
 Fairchild®	MICROCOUPLER™	QT Optoelectronics™	TINYOPTO™
Fairchild Semiconductor®	MicroFET™	Quiet Series™	TinyPower™
FACT Quiet Series™	MicroPak™	RapidConfigure™	TinyPWM™
FACT®	MillerDrive™	SMART START™	TinyWire™
FAST®	Motion-SPM™	SPM®	µSerDes™
FastvCore™	OPTOLOGIC®	STEALTH™	UHC®
FPS™	OPTOPLANAR®	SuperFET™	UniFET™
FRFET®	 Power220®	SuperSOT™-3	VCX™
Global Power Resource <sup>SM</sup>	PDP-SPM™	SuperSOT™-6	

## DISCLAIMER

FAIRCHILD SEMICONDUCTOR RESERVES THE RIGHT TO MAKE CHANGES WITHOUT FURTHER NOTICE TO ANY PRODUCTS HEREIN TO IMPROVE RELIABILITY, FUNCTION, OR DESIGN. FAIRCHILD DOES NOT ASSUME ANY LIABILITY ARISING OUT OF THE APPLICATION OR USE OF ANY PRODUCT OR CIRCUIT DESCRIBED HEREIN; NEITHER DOES IT CONVEY ANY LICENSE UNDER ITS PATENT RIGHTS, NOR THE RIGHTS OF OTHERS. THESE SPECIFICATIONS DO NOT EXPAND THE TERMS OF FAIRCHILD'S WORLDWIDE TERMS AND CONDITIONS, SPECIFICALLY THE WARRANTY THEREIN, WHICH COVERS THESE PRODUCTS.

## LIFE SUPPORT POLICY

FAIRCHILD'S PRODUCTS ARE NOT AUTHORIZED FOR USE AS CRITICAL COMPONENTS IN LIFE SUPPORT DEVICES OR SYSTEMS WITHOUT THE EXPRESS WRITTEN APPROVAL OF FAIRCHILD SEMICONDUCTOR CORPORATION.

As used herein:

- Life support devices or systems are devices or systems which, (a) are intended for surgical implant into the body, or (b) support or sustain life, and (c) whose failure to perform when properly used in accordance with instructions for use provided in the labeling, can be reasonably expected to result in significant injury to the user.
- A critical component is any component of a life support device or system whose failure to perform can be reasonably expected to cause the failure of the life support device or system, or to affect its safety or effectiveness.

## PRODUCT STATUS DEFINITIONS

### Definition of Terms

Datasheet Identification	Product Status	Definition
Advance Information	Formative or In Design	This datasheet contains the design specifications for product development. Specifications may change in any manner without notice.
Preliminary	First Production	This datasheet contains preliminary data; supplementary data will be published at a later date. Fairchild Semiconductor reserves the right to make changes at any time without notice to improve design.
No Identification Needed	Full Production	This datasheet contains final specifications. Fairchild Semiconductor reserves the right to make changes at any time without notice to improve design.
Obsolete	Not In Production	This datasheet contains specifications on a product that has been discontinued by Fairchild semiconductor. The datasheet is printed for reference information only.

Rev. I31