



FGA70N30T

300V, 70A PDP IGBT

Features

- High current capability
- Low saturation voltage: $V_{CE(sat)} = 1.5V @ I_C = 40A$
- High input impedance
- Fast switching
- RoHS compliant



General Description

Using Novel Trench IGBT Technology, Fairchild's new series of trench IGBTs offer the optimum performance for PDP applications where low conduction and switching losses are essential.

Application

- PDP System

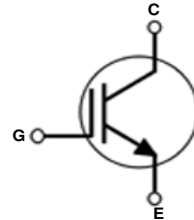
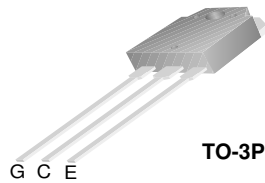

Absolute Maximum Ratings

Symbol	Description	Ratings	Units
V_{CES}	Collector-Emitter Voltage	300	V
V_{GES}	Gate-Emitter Voltage	± 30	V
$I_{C\ pulse(1)*}$	Pulsed Collector Current @ $T_C = 25^\circ C$	160	A
P_D	Maximum Power Dissipation @ $T_C = 25^\circ C$	201	W
	Maximum Power Dissipation @ $T_C = 100^\circ C$	90.6	W
T_J	Operating Junction Temperature	-55 to +150	$^\circ C$
T_{stg}	Storage Temperature Range	-55 to +150	$^\circ C$
T_L	Maximum Lead Temp. for soldering Purposes, 1/8" from case for 5 seconds	300	$^\circ C$

Thermal Characteristics

Symbol	Parameter	Typ.	Max.	Units
$R_{\theta JC}(IGBT)$	Thermal Resistance, Junction-to-Case	--	0.62	$^\circ C/W$
$R_{\theta JA}$	Thermal Resistance, Junction-to-Ambient	--	40	$^\circ C/W$

Notes:

(1) Repetitive test, pulse width = 100usec, Duty = 0.2

* $I_{C\ pulse}$ limited by max T_J

Package Marking and Ordering Information

Device Marking	Device	Package	Packaging Type	Qty per Tube	Max Qty per Box
FGA70N30T	FGA70N30TTU	TO-3P	Tube	30ea	-

Electrical Characteristics T_C = 25°C unless otherwise noted

Symbol	Parameter	Test Conditions	Min.	Typ.	Max.	Units
Off Characteristics						
BV _{CES}	Collector-Emitter Breakdown Voltage	V _{GE} = 0V, I _C = 250uA	300	--	--	V
ΔB _{V_{CES}} / ΔT _J	Temperature Coefficient of Breakdown Voltage	V _{GE} = 0V, I _C = 250uA	--	0.2	--	V/°C
I _{CES}	Collector Cut-Off Current	V _{CE} = V _{CES} , V _{GE} = 0V	--	--	250	uA
I _{GES}	G-E Leakage Current	V _{GE} = V _{GES} , V _{CE} = 0V	--	--	± 400	nA
On Characteristics						
V _{GE(th)}	G-E Threshold Voltage	I _C = 250uA, V _{CE} = V _{GE}	3.0	4.5	5.5	V
V _{CE(sat)}	Collector to Emitter Saturation Voltage	I _C = 20A, V _{GE} = 15V	--	1.2	1.5	V
		I _C = 40A, V _{GE} = 15V	--	1.5	--	V
		I _C = 70A, V _{GE} = 15V T _C = 25°C	--	1.8	--	V
		I _C = 70A, V _{GE} = 15V T _C = 125°C	--	1.9	--	V
Dynamic Characteristics						
C _{ies}	Input Capacitance	V _{CE} = 30V, V _{GE} = 0V f = 1MHz	--	3000	--	pF
C _{oes}	Output Capacitance		--	160	--	pF
C _{res}	Reverse Transfer Capacitance		--	110	--	pF
Switching Characteristics						
t _{d(on)}	Turn-On Delay Time	V _{CC} = 200V, I _C = 40A R _G = 15Ω, V _{GE} = 15V Resistive Load, T _C = 25°C	--	32	--	ns
t _r	Rise Time		--	90	--	ns
t _{d(off)}	Turn-Off Delay Time		--	175	--	ns
t _f	Fall Time		--	170	300	ns
t _{d(on)}	Turn-On Delay Time	V _{CC} = 200V, I _C = 40A R _G = 15Ω, V _{GE} = 15V Resistive Load, T _C = 125°C	--	30	--	ns
t _r	Rise Time		--	90	--	ns
t _{d(off)}	Turn-Off Delay Time		--	185	--	ns
t _f	Fall Time		--	235	--	ns
Q _g	Total Gate Charge	V _{CE} = 200V, I _C = 40A V _{GE} = 15V	--	125	--	nC
Q _{ge}	Gate-Emitter Charge		--	25	--	nC
Q _{gc}	Gate-Collector Charge		--	55	--	nC

Typical Performance Characteristics

Figure 1. Typical Output Characteristics

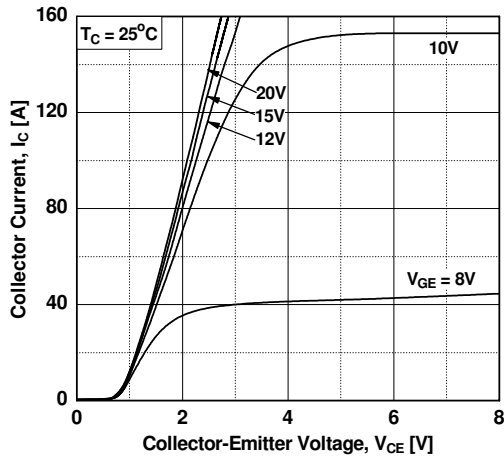

Figure 2. Typical Output Characteristics

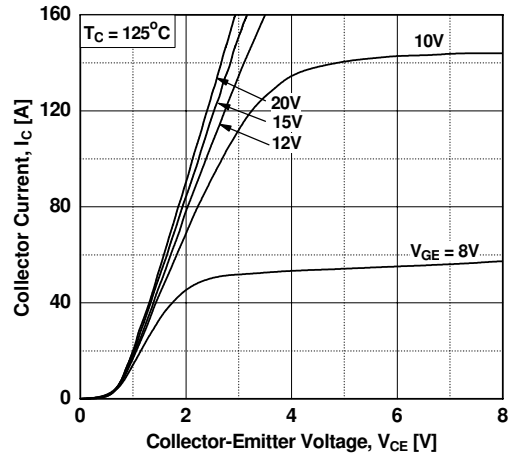

Figure 3. Typical Saturation Voltage Characteristics

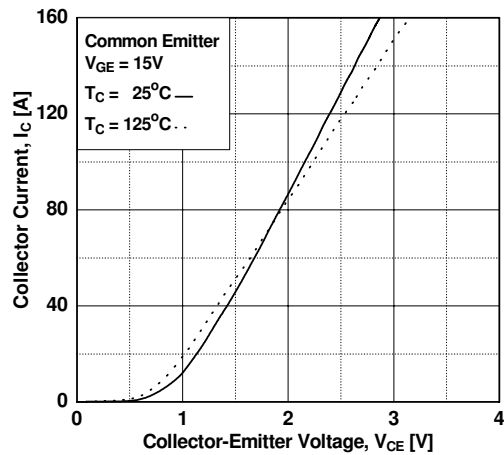

Figure 4. Transfer Characteristics

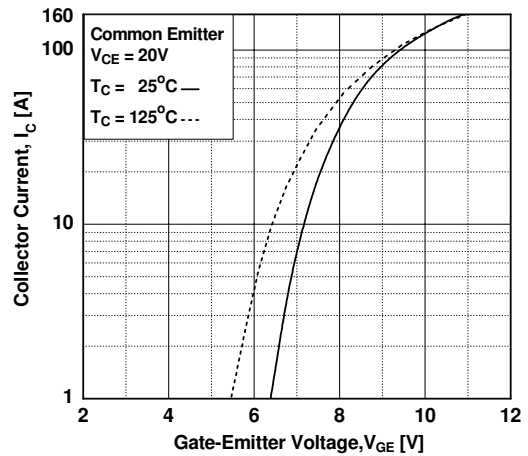

Figure 5. Saturation Voltage vs. Case Temperature at Variant Current Level

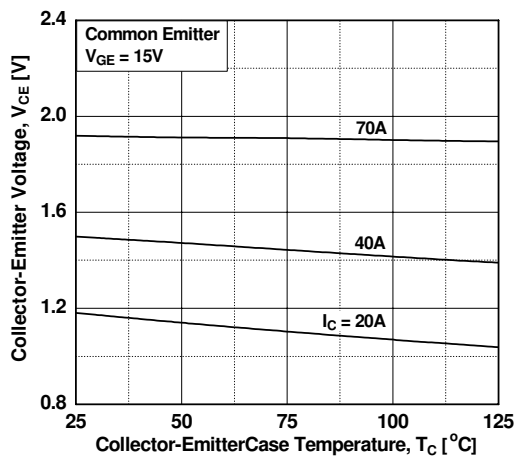
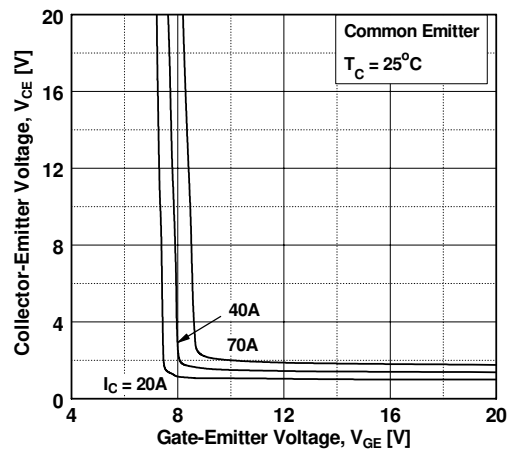

Figure 6. Saturation Voltage vs. Vge



Typical Performance Characteristics (Continued)

Figure 7. Saturation Voltage vs. V_{GE}

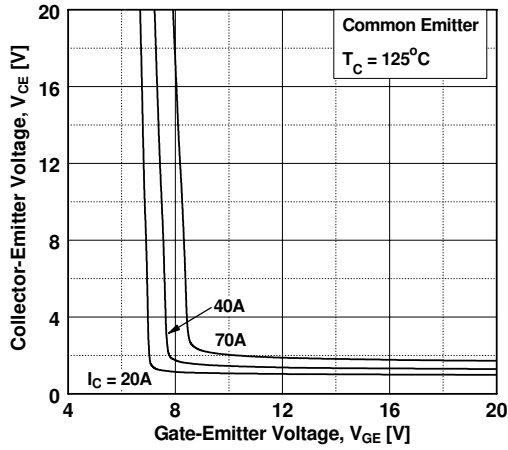

Figure 8. Capacitance Characteristics

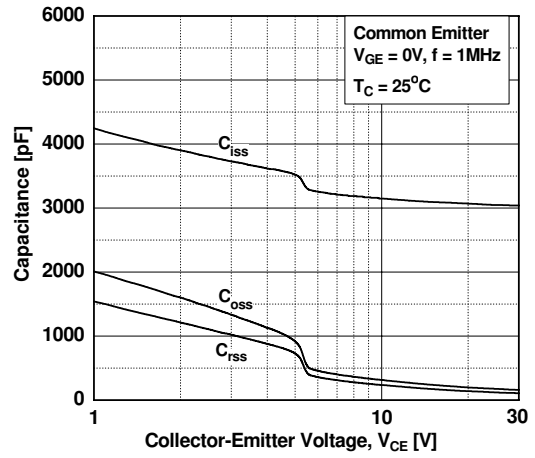

Figure 9. Gate Charge Characteristics

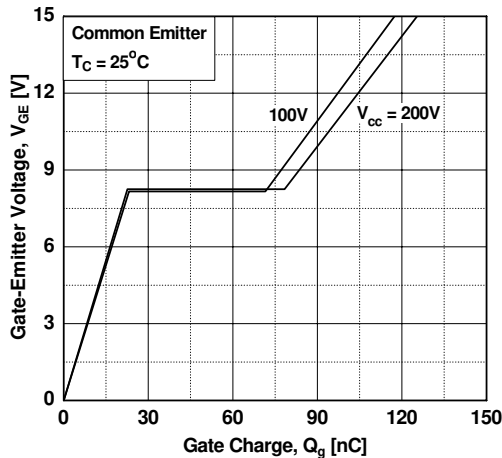

Figure 10. SOA Characteristics

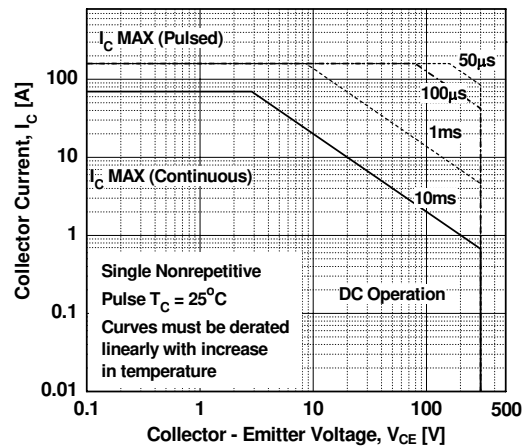

Figure 11. Turn-on Characteristics vs. Gate Resistance

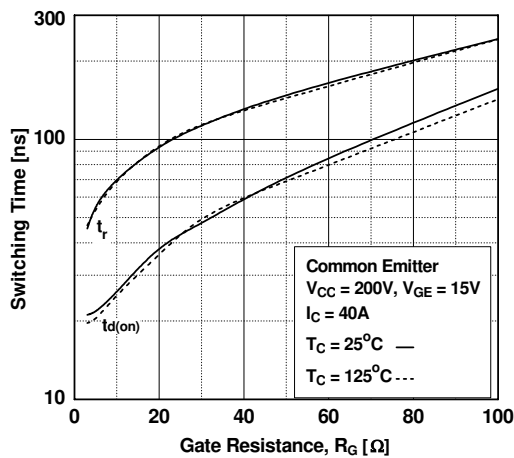
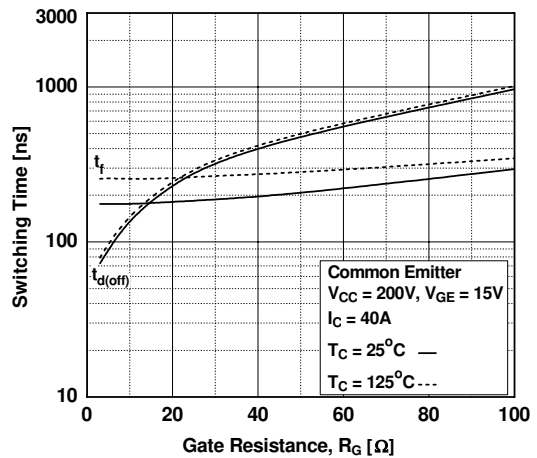

Figure 12. Turn-off Characteristics vs. Gate Resistance



Typical Performance Characteristics (Continued)

Figure 13. Turn-on Characteristics vs. Collector Current

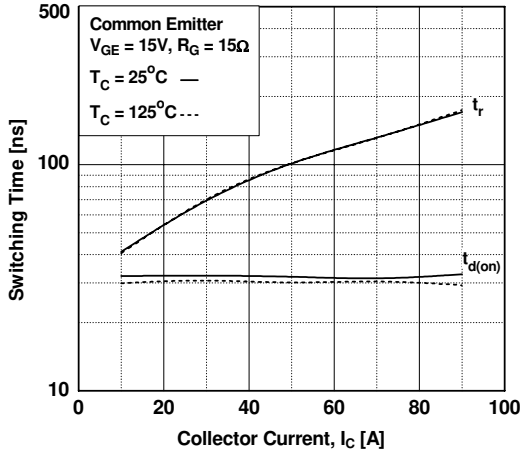

Figure 14. Turn-off Characteristics vs. Collector Current

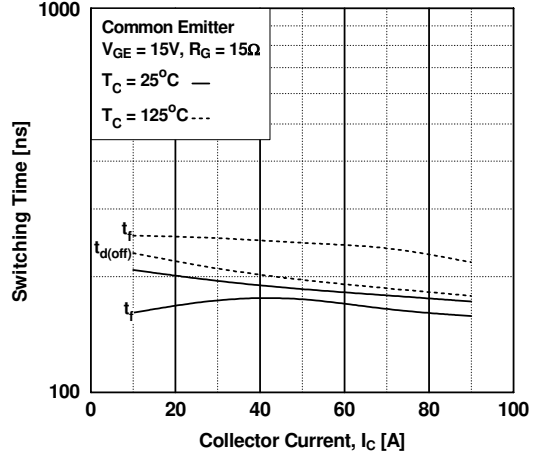

Figure 15. Switching Loss vs. Gate Resistance

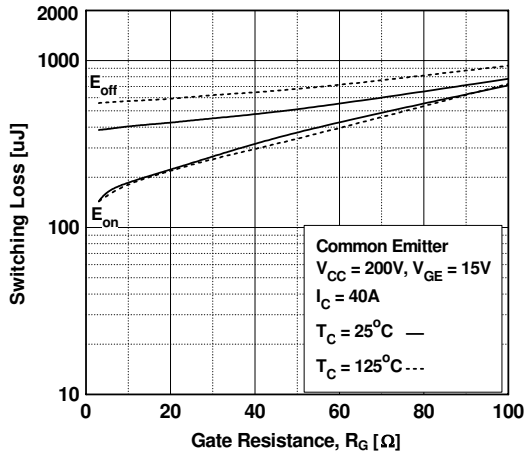

Figure 16. Switching Loss vs. Collector Current

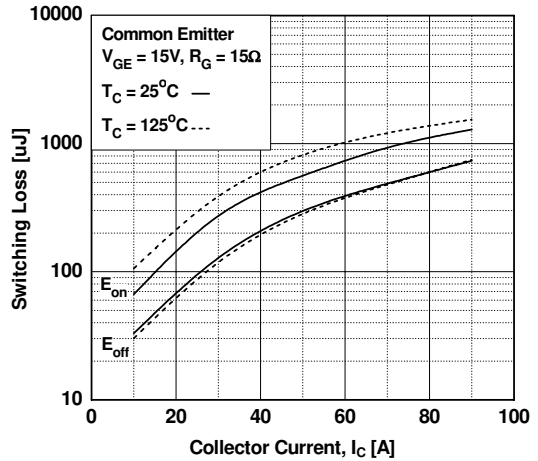
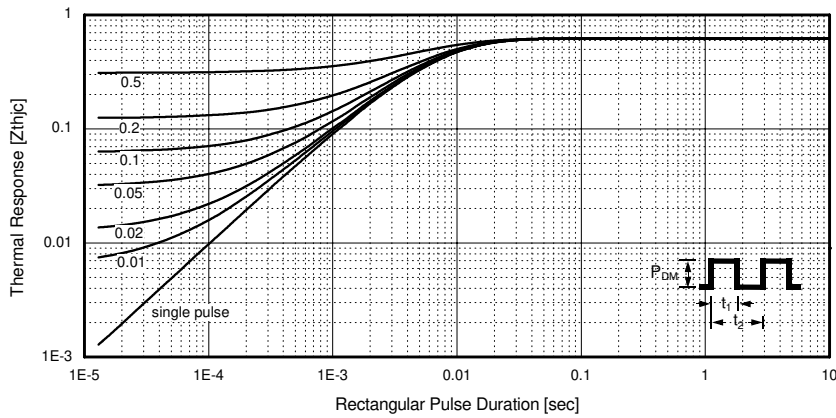
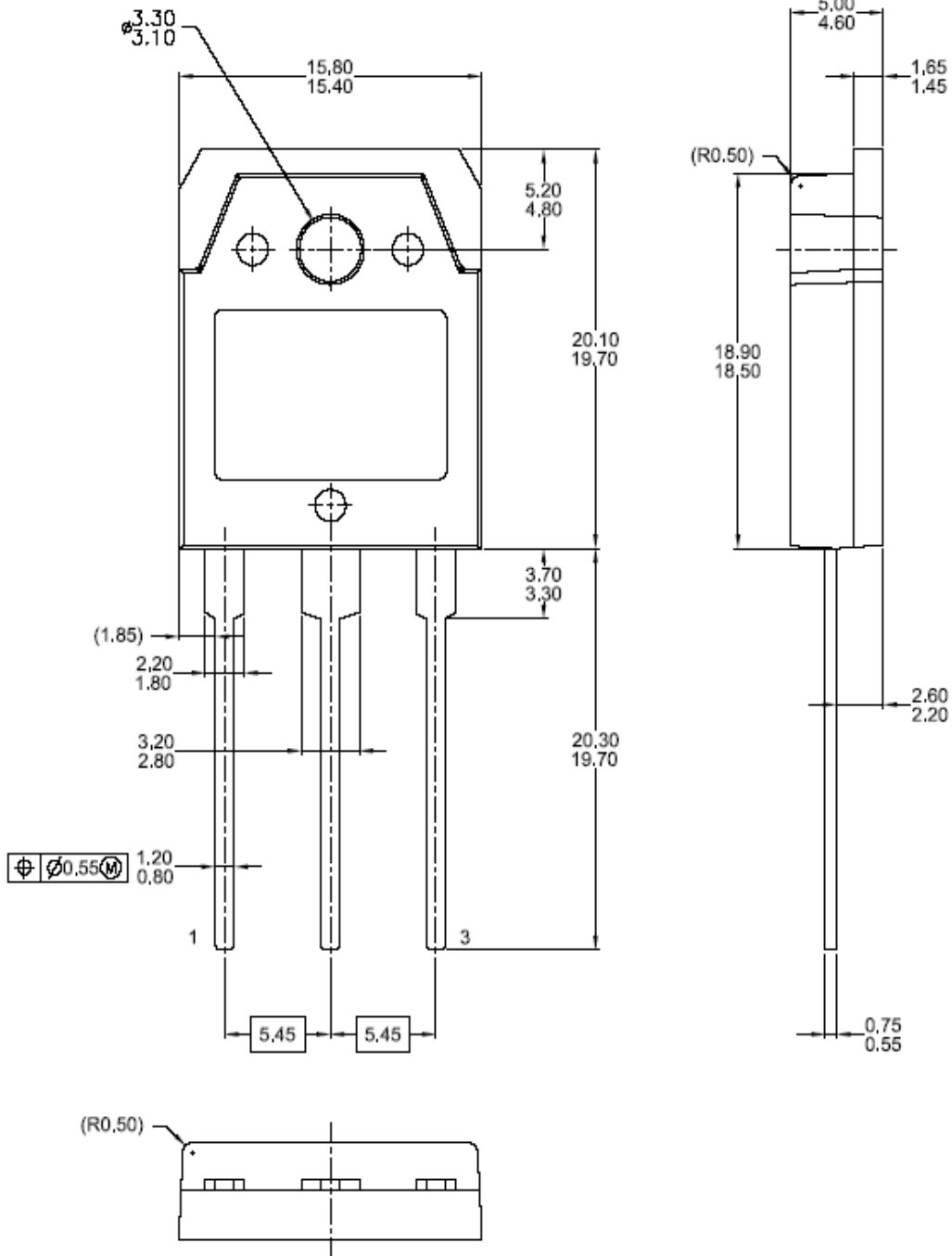

Figure 17. Transient Thermal Impedance of IGBT



TO-3PN





TRADEMARKS

The following are registered and unregistered trademarks Fairchild Semiconductor owns or is authorized to use and is not intended to be an exhaustive list of all such trademarks.

ACE [®]	HiSeC [™]	PowerSaver [™]	TinyBoost [™]
Across the board. Around the world.™	<i>i-Lo</i> [™]	PowerTrench™	TinyBuck [™]
ActiveArray [™]	ImpliedDisconnect [™]	Programmable Active Droop [™]	TinyLogic [®]
Bottomless [™]	IntelliMAX [™]	QFET [®]	TINYOPTO [™]
Build it Now [™]	ISOPLANAR [™]	QST [™]	TinyPower [™]
CoolFET [™]	MICROCOUPLER [™]	QT Optoelectronics [™]	TinyWire [™]
<i>CROSSVOLT</i> [™]	MicroPak [™]	Quiet Series [™]	TruTranslation [™]
CTL [™]	MICROWIRE [™]	RapidConfigure [™]	μSerDes [™]
Current Transfer Logic [™]	Motion-SPM [™]	RapidConnect [™]	UHC [®]
DOME [™]	MSX [™]	ScalarPump [™]	UniFET [™]
E ² CMOS [™]	MSXPro [™]	SMART START [™]	VCX [™]
EcoSPARK [®]	OCX [™]	SPM [®]	Wire [™]
EnSigna [™]	OCXPro [™]	STEALTH [™]	
FACT Quiet Series [™]	OPTOLOGIC [®]	SuperFET [™]	
FACT [®]	OPTOPLANAR [®]	SuperSOT [™] -3	
FAST [®]	PACMAN [™]	SuperSOT [™] -6	
FAST _r [™]	PDP-SPM [™]	SuperSOT [™] -8	
FPS [™]	POP [™]	SyncFET [™]	
FRFET [®]	Power220 [®]	TCM [™]	
GlobalOptoisolator [™]	Power247 [®]	The Power Franchise [®]	
GTO,	PowerEdge,		

DISCLAIMER

FAIRCHILD SEMICONDUCTOR RESERVES THE RIGHT TO MAKE CHANGES WITHOUT FURTHER NOTICE TO ANY PRODUCTS HEREIN TO IMPROVE RELIABILITY, FUNCTION OR DESIGN. FAIRCHILD DOES NOT ASSUME ANY LIABILITY ARISING OUT OF THE APPLICATION OR USE OF ANY PRODUCT OR CIRCUIT DESCRIBED HEREIN; NEITHER DOES IT CONVEY ANY LICENSE UNDER ITS PATENT RIGHTS, NOR THE RIGHTS OF OTHERS. THESE SPECIFICATIONS DO NOT EXPAND THE TERMS OF FAIRCHILD'S WORLDWIDE TERMS AND CONDITIONS, SPECIFICALLY THE WARRANTY THEREIN, WHICH COVERS THESE PRODUCTS.

LIFE SUPPORT POLICY

FAIRCHILD'S PRODUCTS ARE NOT AUTHORIZED FOR USE AS CRITICAL COMPONENTS IN LIFE SUPPORT DEVICES OR SYSTEMS WITHOUT THE EXPRESS WRITTEN APPROVAL OF FAIRCHILD SEMICONDUCTOR CORPORATION.

As used herein:

1. Life support devices or systems are devices or systems which, (a) are intended for surgical implant into the body or (b) support or sustain life, and (c) whose failure to perform when properly used in accordance with instructions for use provided in the labeling, can be reasonably expected to result in a significant injury of the user.
2. A critical component in any component of a life support, device, or system whose failure to perform can be reasonably expected to cause the failure of the life support device or system, or to affect its safety or effectiveness.

PRODUCT STATUS DEFINITIONS

Definition of Terms

Datasheet Identification	Product Status	Definition
Advance Information	Formative or In Design	This datasheet contains the design specifications for product development. Specifications may change in any manner without notice.
Preliminary	First Production	This datasheet contains preliminary data; supplementary data will be published at a later date. Fairchild Semiconductor reserves the right to make changes at any time without notice to improve design.
No Identification Needed	Full Production	This datasheet contains final specifications. Fairchild Semiconductor reserves the right to make changes at any time without notice to improve design.
Obsolete	Not In Production	This datasheet contains specifications on a product that has been discontinued by Fairchild Semiconductor. The datasheet is printed for reference information only.

Rev. I25