

## Automotive-grade trench gate field-stop IGBT, HB series 600 V, 30 A high speed

Datasheet - production data

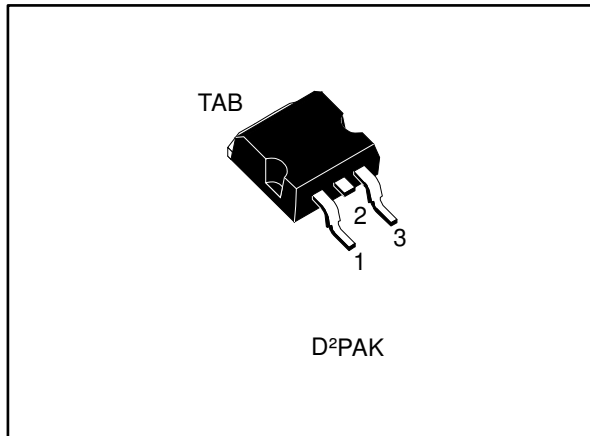
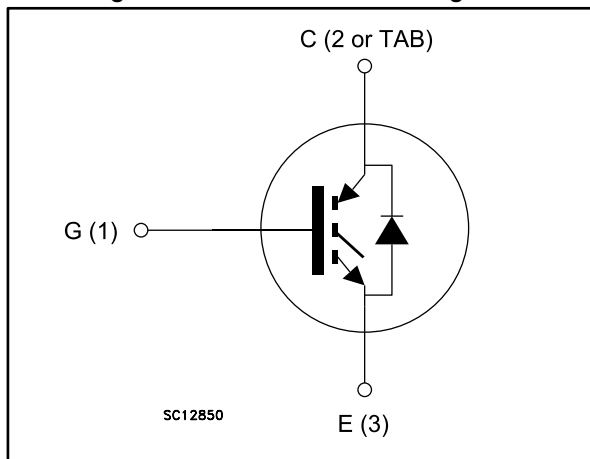

Figure 1: Internal schematic diagram



### Features

- AEC-Q101 qualified
- Maximum junction temperature:  $T_J = 175\text{ °C}$
- Logic level gate drive
- High speed switching series
- Minimized tail current
- $V_{CE(sat)} = 1.7\text{ V (typ.) @ } I_C = 30\text{ A}$
- Low  $V_F$  soft recovery co-packaged diode
- Tight parameters distribution
- Safer paralleling
- Low thermal resistance



### Applications

- Ignition

### Description

This device is an IGBT developed using an advanced proprietary trench gate field-stop structure. The device is part of the new HB series of IGBTs, which represents an optimum compromise between conduction and switching loss to maximize the efficiency of any frequency converter. Furthermore, the slightly positive  $V_{CE(sat)}$  temperature coefficient and very tight parameter distribution result in safer paralleling operation.

Table 1: Device summary

Order code	Marking	Package	Packaging
STGB30H60DLLFBAG	GB30H60DLLFB	D <sup>2</sup> PAK	Tape and reel

---

**Contents**

<b>1</b>	<b>Electrical ratings .....</b>	<b>3</b>
<b>2</b>	<b>Electrical characteristics .....</b>	<b>4</b>
	2.1 Electrical characteristics (curves) .....	5
<b>3</b>	<b>Test circuits .....</b>	<b>10</b>
<b>4</b>	<b>Package information .....</b>	<b>11</b>
	4.1 D <sup>2</sup> PAK package information .....	11
	4.2 D <sup>2</sup> PAK packing information .....	14
<b>5</b>	<b>Revision history .....</b>	<b>16</b>

# 1 Electrical ratings

**Table 2: Absolute maximum ratings**

Symbol	Parameter	Value	Unit
$V_{CES}$	Collector-emitter voltage ( $V_{GE} = 0$ )	600	V
$I_C$	Continuous collector current at $T_C = 25\text{ °C}$	60	A
$I_C$	Continuous collector current at $T_C = 100\text{ °C}$	30	A
$I_{CP}^{(1)}$	Pulsed collector current	120	A
$V_{GE}$	Gate-emitter voltage	$\pm 20$	V
$I_F$	Continuous forward current at $T_C = 25\text{ °C}$	60	A
	Continuous forward current at $T_C = 100\text{ °C}$	30	
$I_{FP}^{(1)}$	Pulsed forward current	120	A
$P_{TOT}$	Total dissipation at $T_C = 25\text{ °C}$	260	W
$T_{STG}$	Storage temperature range	- 55 to 150	$^{\circ}\text{C}$
$T_J$	Operating junction temperature range	- 55 to 175	$^{\circ}\text{C}$

**Notes:**

<sup>(1)</sup>Pulse width limited by maximum junction temperature.

**Table 3: Thermal data**

Symbol	Parameter	Value	Unit
$R_{thJC}$	Thermal resistance junction-case IGBT	0.58	$^{\circ}\text{C}/\text{W}$
	Thermal resistance junction-case diode	2.08	
$R_{thJA}$	Thermal resistance junction-ambient	62.5	$^{\circ}\text{C}/\text{W}$

## 2 Electrical characteristics

$T_C = 25\text{ °C}$  unless otherwise specified

**Table 4: Static characteristics**

Symbol	Parameter	Test conditions	Min.	Typ.	Max.	Unit
$V_{(BR)CES}$	Collector-emitter breakdown voltage	$V_{GE} = 0\text{ V}$ , $I_C = 1\text{ mA}$	600			V
$V_{CE(sat)}$	Collector-emitter saturation voltage	$V_{GE} = 5\text{ V}$ , $I_C = 30\text{ A}$		1.7	2.15	V
		$V_{GE} = 5\text{ V}$ , $I_C = 30\text{ A}$ , $T_J = 125\text{ °C}$		1.9		
		$V_{GE} = 5\text{ V}$ , $I_C = 30\text{ A}$ , $T_J = 175\text{ °C}$		2		
$V_F$	Forward on-voltage	$I_F = 30\text{ A}$		1.4	1.7	V
		$I_F = 30\text{ A}$ , $T_J = 125\text{ °C}$		1.35		
		$I_F = 30\text{ A}$ , $T_J = 175\text{ °C}$		1.25		
$V_{GE(th)}$	Gate threshold voltage	$V_{CE} = V_{GE}$ , $I_C = 1\text{ mA}$		1.8	2.5	V
$I_{CES}$	Collector cut-off current	$V_{GE} = 0\text{ V}$ , $V_{CE} = 600\text{ V}$			25	$\mu\text{A}$
$I_{GES}$	Gate-emitter leakage current	$V_{CE} = 0\text{ V}$ , $V_{GE} = \pm 10\text{ V}$			$\pm 250$	$\mu\text{A}$

**Table 5: Dynamic characteristics**

Symbol	Parameter	Test conditions	Min.	Typ.	Max.	Unit
$C_{ies}$	Input capacitance	$V_{CE} = 25\text{ V}$ , $f = 1\text{ MHz}$ , $V_{GE} = 0\text{ V}$	-	5000	-	pF
$C_{oes}$	Output capacitance		-	120	-	
$C_{res}$	Reverse transfer capacitance		-	75	-	
$Q_g$	Total gate charge	$V_{CC} = 520\text{ V}$ , $I_C = 30\text{ A}$ , $V_{GE} = 5\text{ V}$ (see <a href="#">Figure 26: "Gate charge test circuit"</a> )	-	110	-	nC
$Q_{ge}$	Gate-emitter charge		-	16	-	
$Q_{gc}$	Gate-collector charge		-	42	-	

**Table 6: IGBT switching characteristics (inductive load)**

Symbol	Parameter	Test conditions	Min.	Typ.	Max.	Unit
$t_{d(off)}$	Turn-off delay time	$V_{CE} = 400\text{ V}$ , $I_C = 30\text{ A}$ , $V_{GE} = 5\text{ V}$ , $R_G = 10\ \Omega$ (see <a href="#">Figure 25: "Test circuit for inductive load switching"</a> )		320	-	ns
$t_f$	Current fall time			20	-	ns
$E_{off}^{(1)}$	Turn-off switching energy				600	-
$t_{d(off)}$	Turn-off delay time	$V_{CE} = 400\text{ V}$ , $I_C = 30\text{ A}$ , $V_{GE} = 5\text{ V}$ , $R_G = 10\ \Omega$ , $T_J = 175\text{ °C}$ (see <a href="#">Figure 25: "Test circuit for inductive load switching"</a> )		330	-	ns
$t_f$	Current fall time			40	-	ns
$E_{off}^{(1)}$	Turn-off switching energy				880	-

**Notes:**

<sup>(1)</sup>Including the tail of the collector current.

2.1 Electrical characteristics (curves)

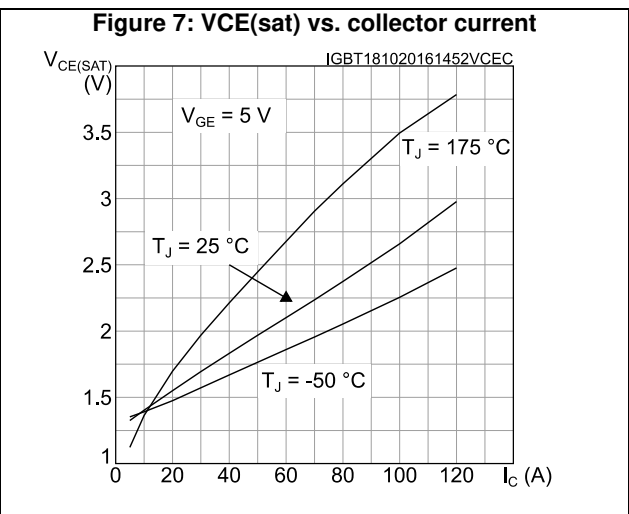
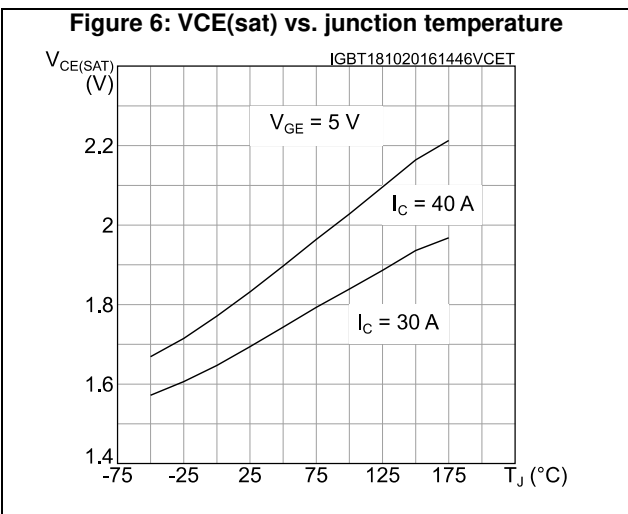
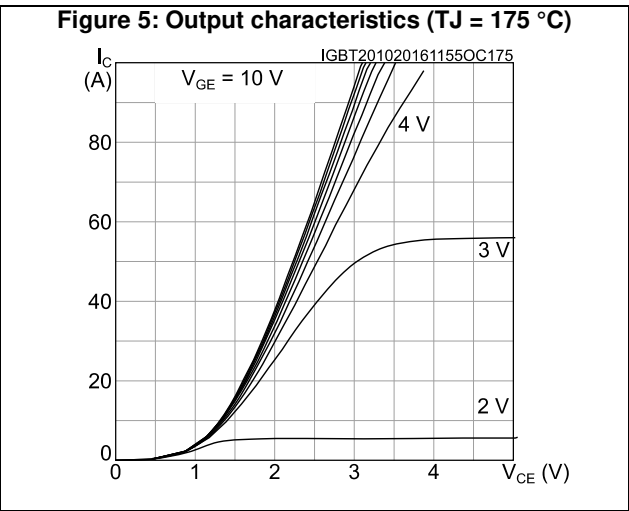
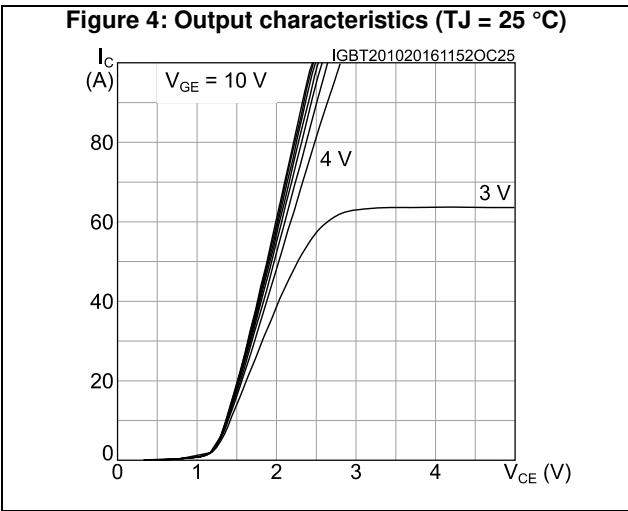
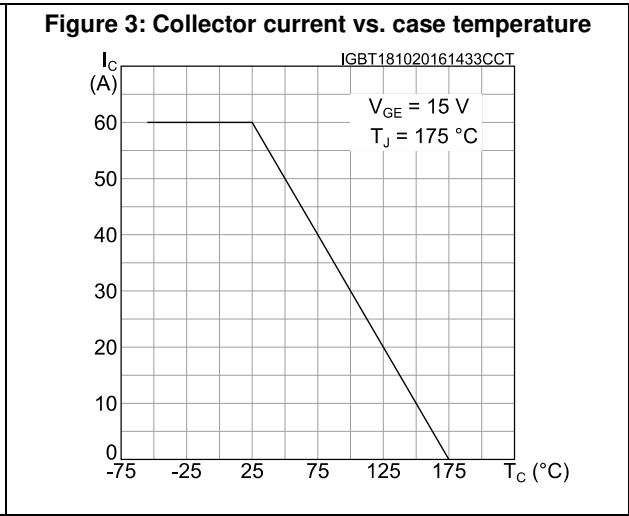
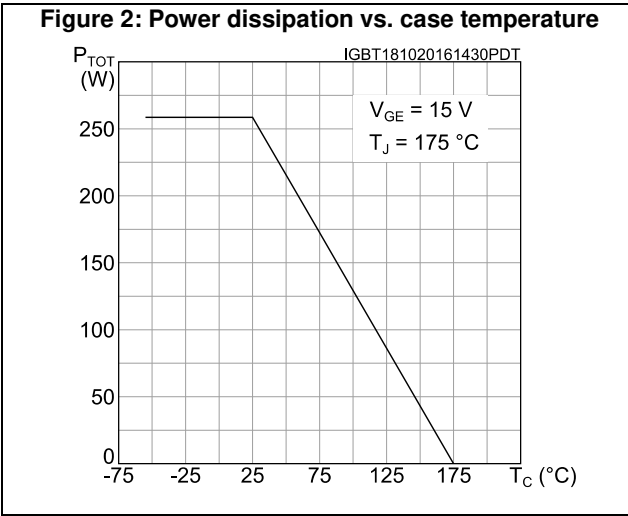

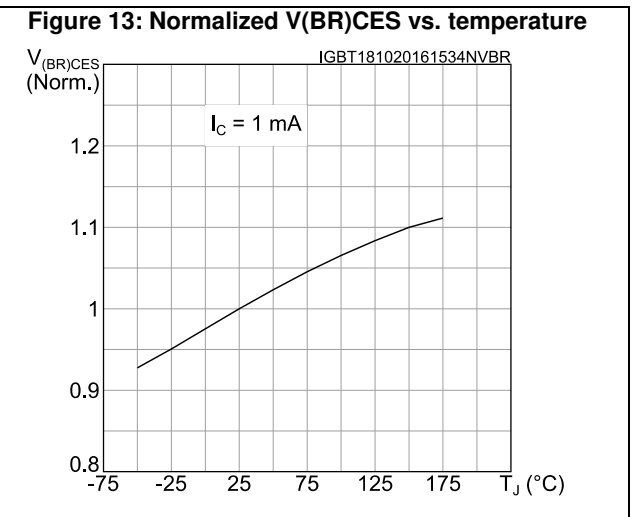
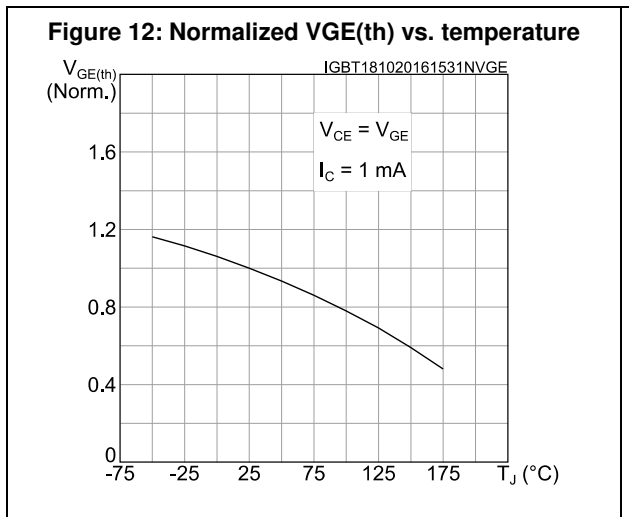
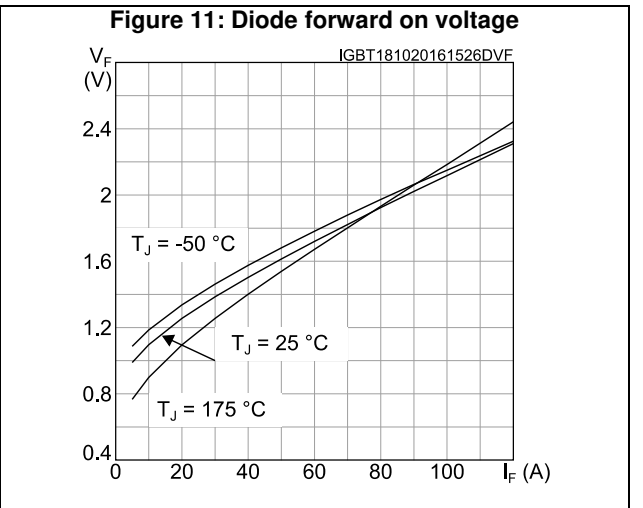
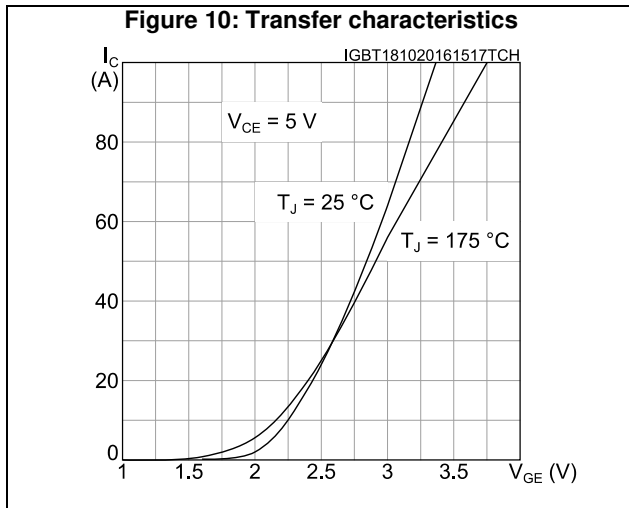
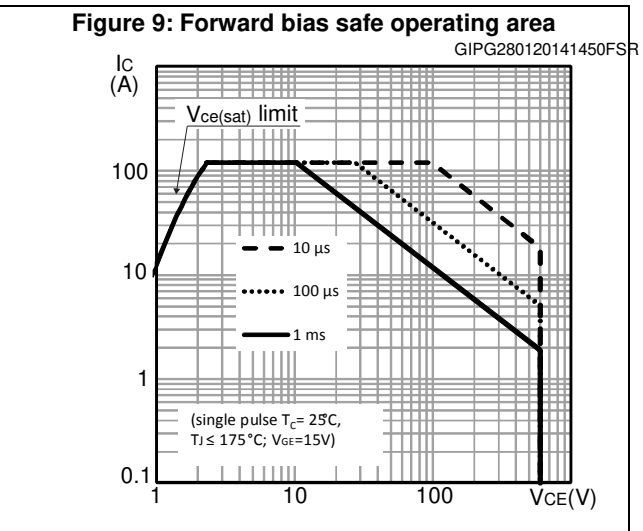
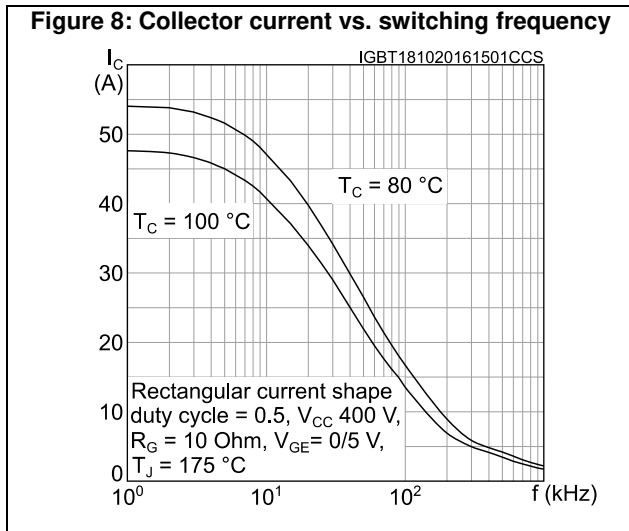

Figure 14: Diode forward on voltage vs. temperature

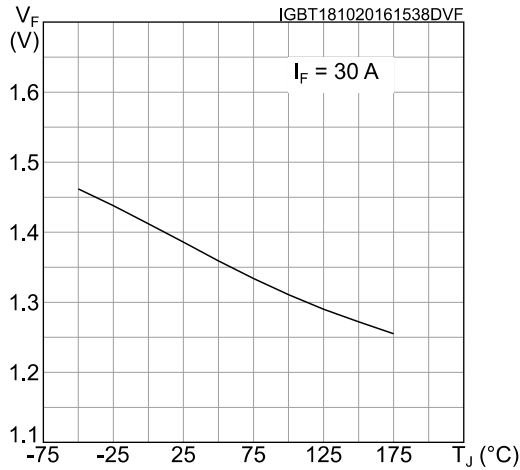

Figure 15: Capacitance variations

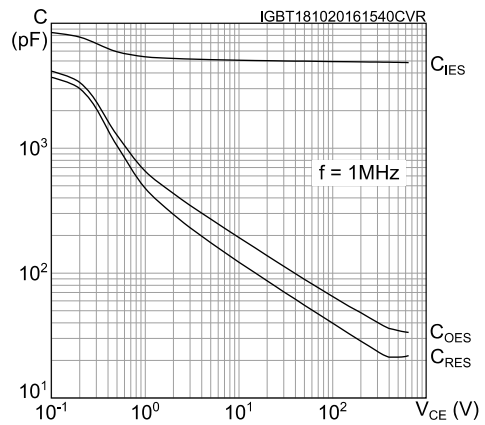

Figure 16: Gate charge vs. gate-emitter voltage

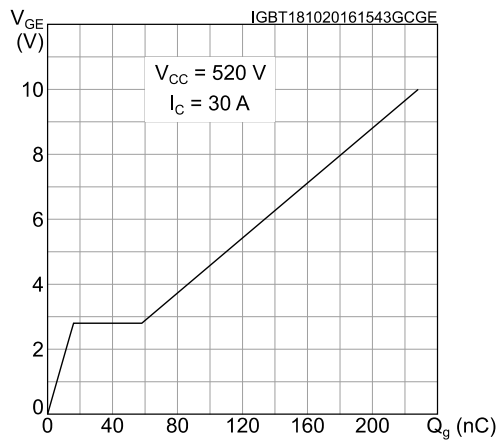

Figure 17: Switching energy vs. collector current

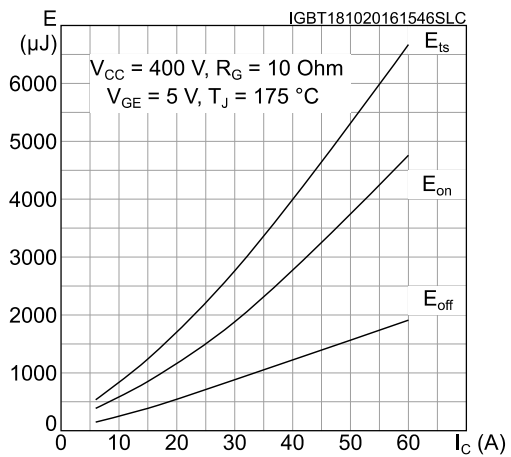

Figure 18: Switching energy vs. gate resistance

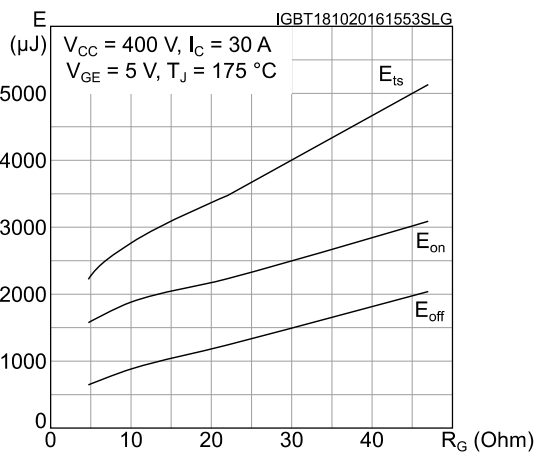
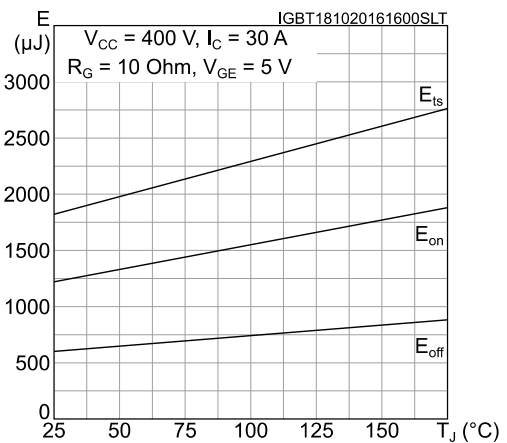

Figure 19: Switching energy vs. temperature



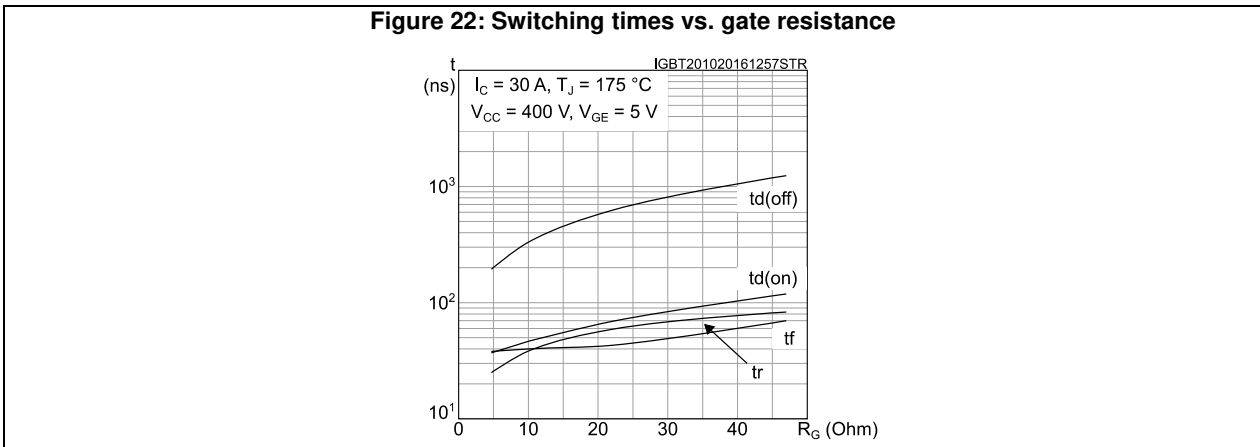
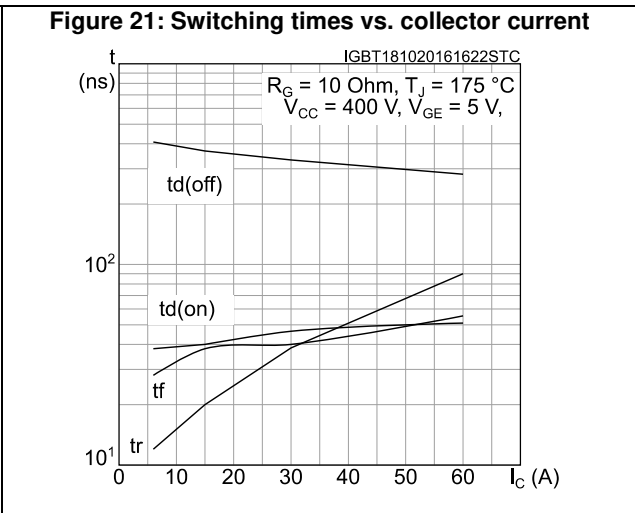
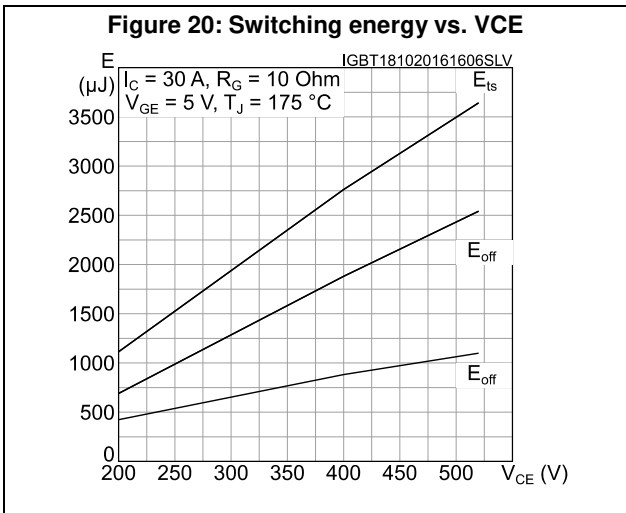



Figure 23: Thermal impedance for IGBT

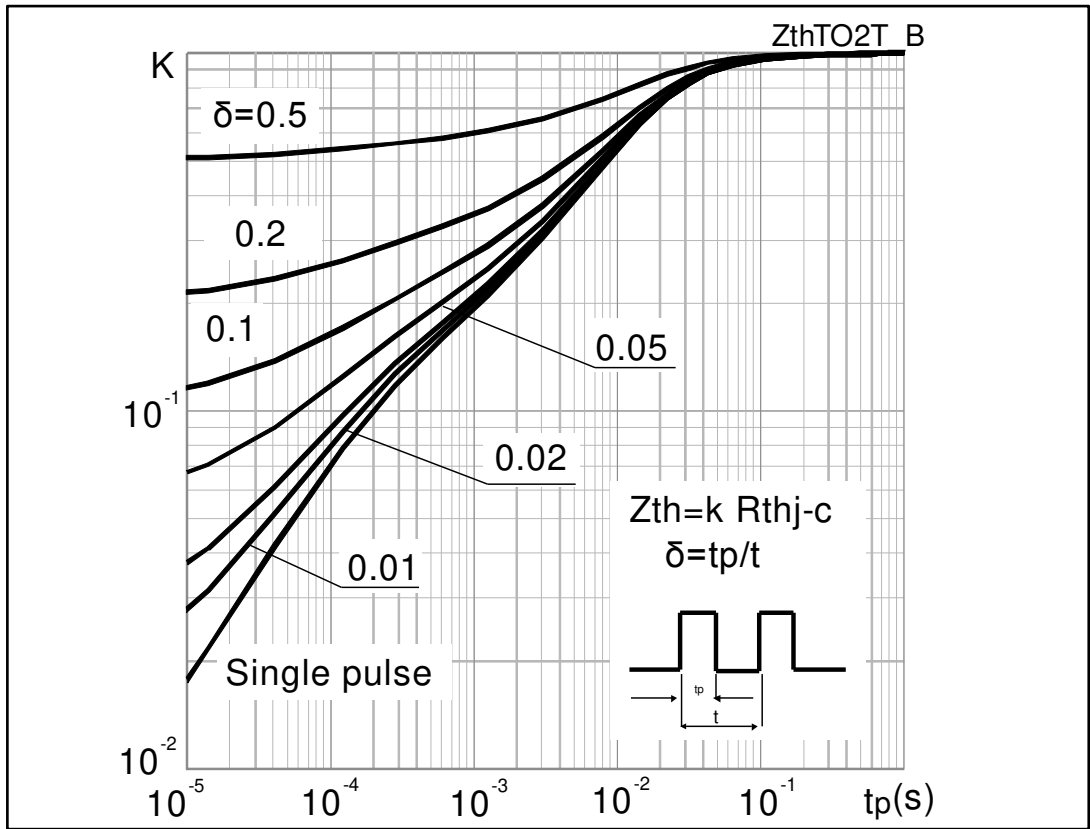
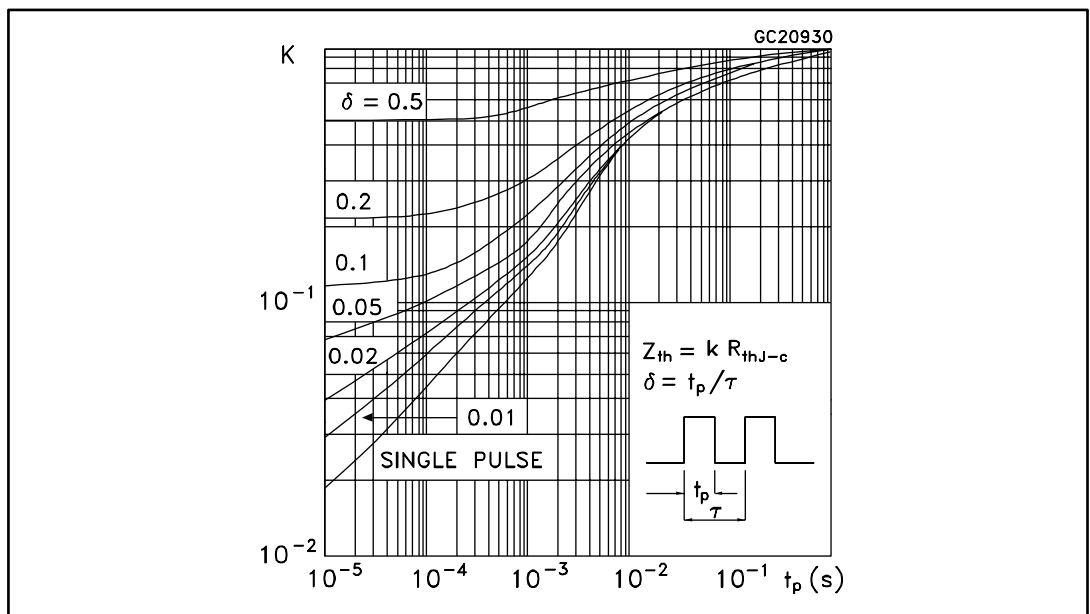

Figure 24: Thermal impedance for diode





## 4 Package information

In order to meet environmental requirements, ST offers these devices in different grades of ECOPACK® packages, depending on their level of environmental compliance. ECOPACK® specifications, grade definitions and product status are available at: [www.st.com](http://www.st.com). ECOPACK® is an ST trademark.

### 4.1 D<sup>2</sup>PAK package information

Figure 29: D<sup>2</sup>PAK (TO-263) type A package outline

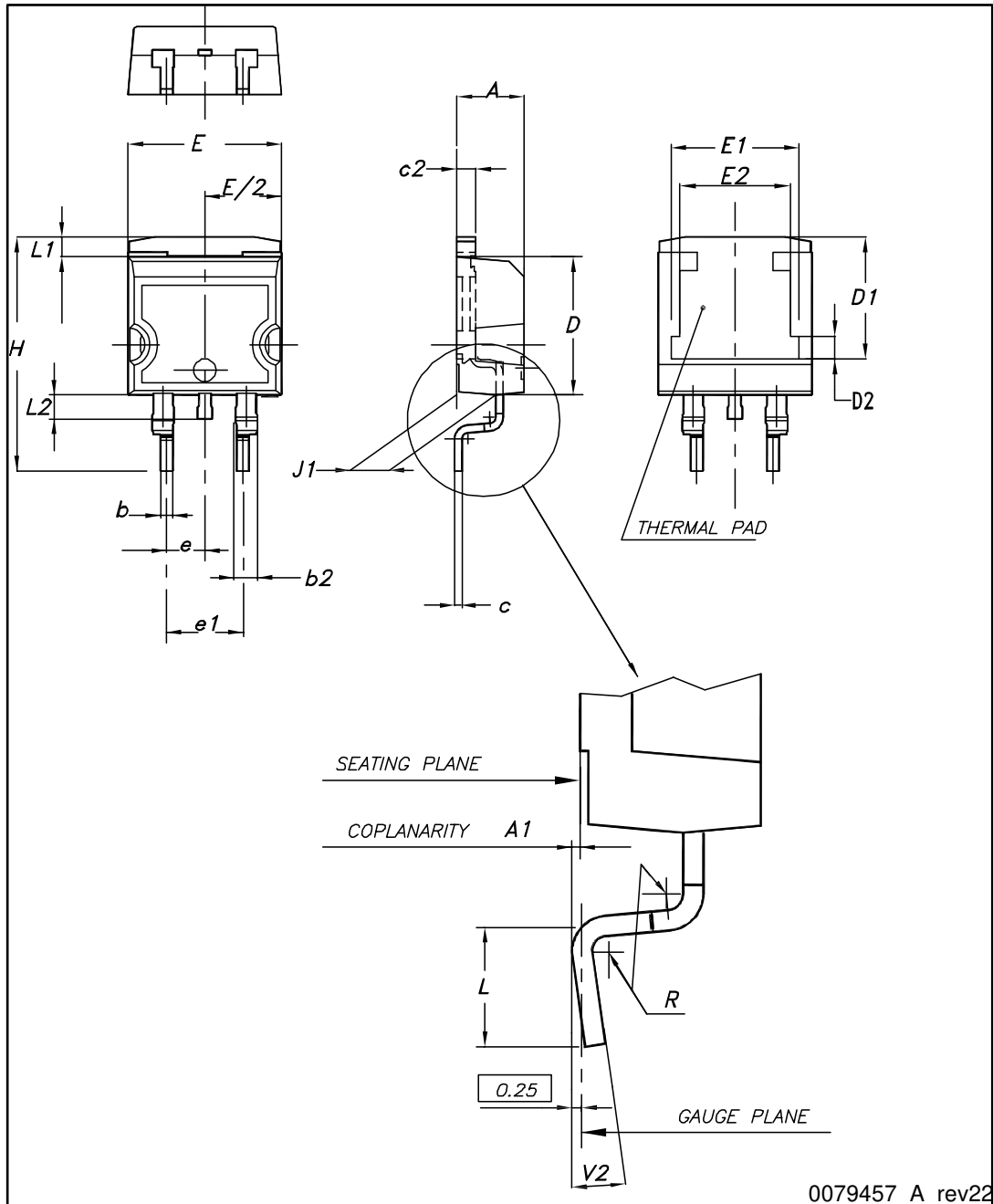
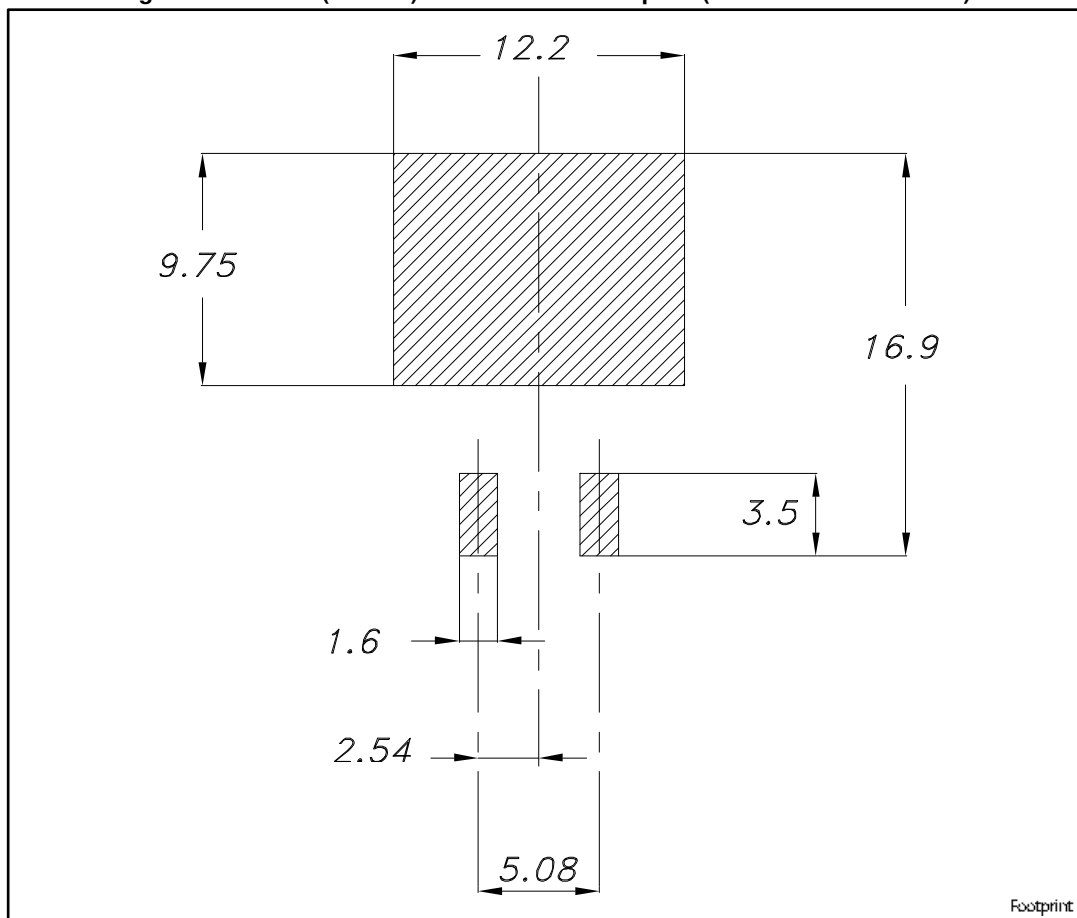

Table 7: D<sup>2</sup>PAK (TO-263) type A package mechanical data

Dim.	mm		
	Min.	Typ.	Max.
A	4.40		4.60
A1	0.03		0.23
b	0.70		0.93
b2	1.14		1.70
c	0.45		0.60
c2	1.23		1.36
D	8.95		9.35
D1	7.50	7.75	8.00
D2	1.10	1.30	1.50
E	10		10.40
E1	8.50	8.70	8.90
E2	6.85	7.05	7.25
e		2.54	
e1	4.88		5.28
H	15		15.85
J1	2.49		2.69
L	2.29		2.79
L1	1.27		1.40
L2	1.30		1.75
R		0.4	
V2	0°		8°

Figure 30: D<sup>2</sup>PAK (TO-263) recommended footprint (dimensions are in mm)



### 4.2 D<sup>2</sup>PAK packing information

Figure 31: Tape outline

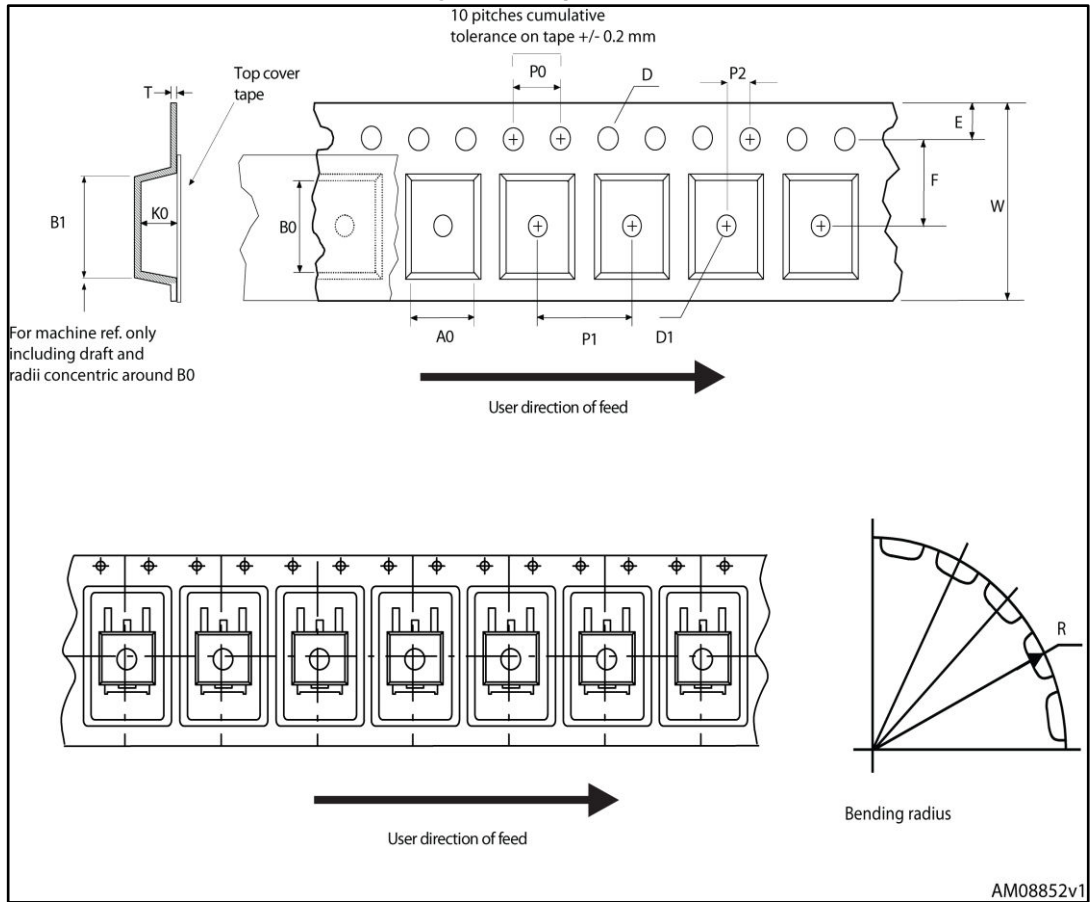
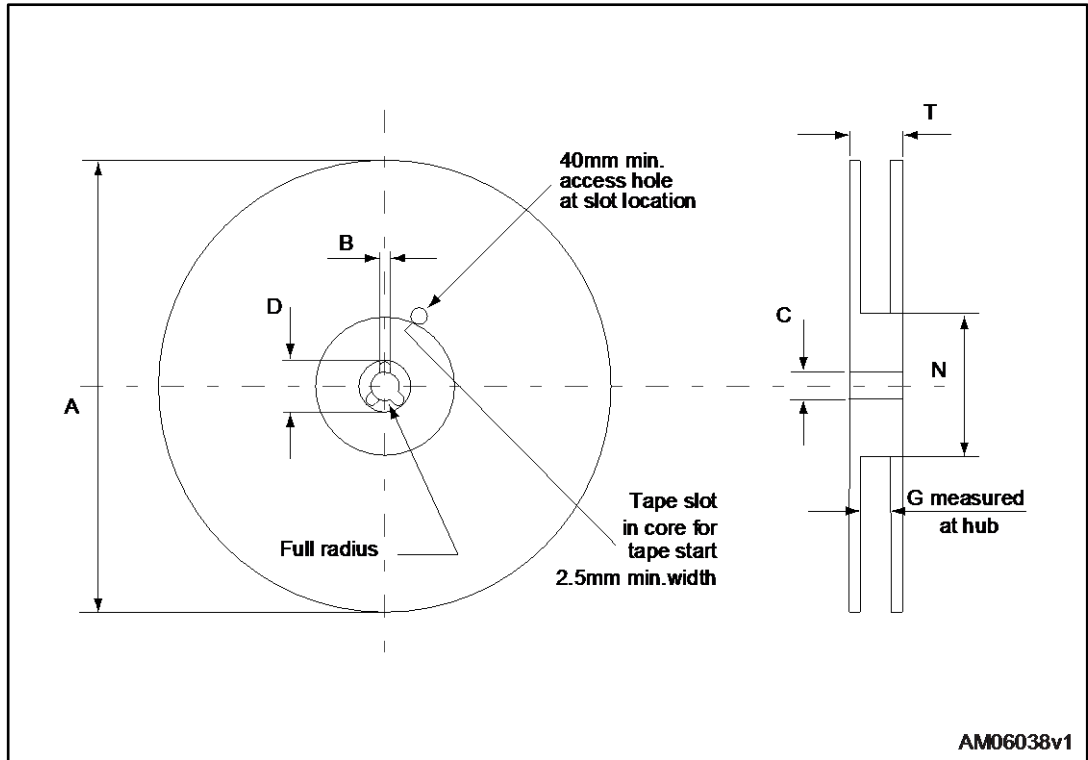

Figure 32: Reel outline



AM06038v1

Table 8: D<sup>2</sup>PAK tape and reel mechanical data

Tape			Reel		
Dim.	mm		Dim.	mm	
	Min.	Max.		Min.	Max.
A0	10.5	10.7	A		330
B0	15.7	15.9	B	1.5	
D	1.5	1.6	C	12.8	13.2
D1	1.59	1.61	D	20.2	
E	1.65	1.85	G	24.4	26.4
F	11.4	11.6	N	100	
K0	4.8	5.0	T		30.4
P0	3.9	4.1			
P1	11.9	12.1	Base quantity		1000
P2	1.9	2.1	Bulk quantity		1000
R	50				
T	0.25	0.35			
W	23.7	24.3			

## 5 Revision history

Table 9: Document revision history

Date	Revision	Changes
18-Oct-2016	1	First release.



**IMPORTANT NOTICE – PLEASE READ CAREFULLY**

STMicroelectronics NV and its subsidiaries ("ST") reserve the right to make changes, corrections, enhancements, modifications, and improvements to ST products and/or to this document at any time without notice. Purchasers should obtain the latest relevant information on ST products before placing orders. ST products are sold pursuant to ST's terms and conditions of sale in place at the time of order acknowledgement.

Purchasers are solely responsible for the choice, selection, and use of ST products and ST assumes no liability for application assistance or the design of Purchasers' products.

No license, express or implied, to any intellectual property right is granted by ST herein.

Resale of ST products with provisions different from the information set forth herein shall void any warranty granted by ST for such product.

ST and the ST logo are trademarks of ST. All other product or service names are the property of their respective owners.

Information in this document supersedes and replaces information previously supplied in any prior versions of this document.

© 2016 STMicroelectronics – All rights reserved