



# STGD10NC60H

N-channel 10A - 600V - DPAK  
Very fast PowerMESH™ IGBT

## Features

| Type        | V <sub>CE(S)</sub> | V <sub>CE(sat)</sub><br>(Max)@ 25°C | I <sub>C</sub><br>@100°C |
|-------------|--------------------|-------------------------------------|--------------------------|
| STGD10NC60H | 600V               | < 2.5V                              | 10A                      |

- Low on-voltage drop (V<sub>cesat</sub>)
- Low C<sub>RES</sub> / C<sub>IES</sub> ratio (no cross-conduction susceptibility)

## Description

Using the latest high voltage technology based on a patented strip layout, STMicroelectronics has designed an advanced family of IGBTs, the PowerMESH™ IGBTs, with outstanding performances. The suffix "H" identifies a family optimized for high frequency applications in order to achieve very high switching performances (reduced t<sub>fall</sub>) maintaining a low voltage drop.

## Applications

- High frequency motor controls
- SMPS and PFC in both hard switch and resonant topologies
- Motor drivers

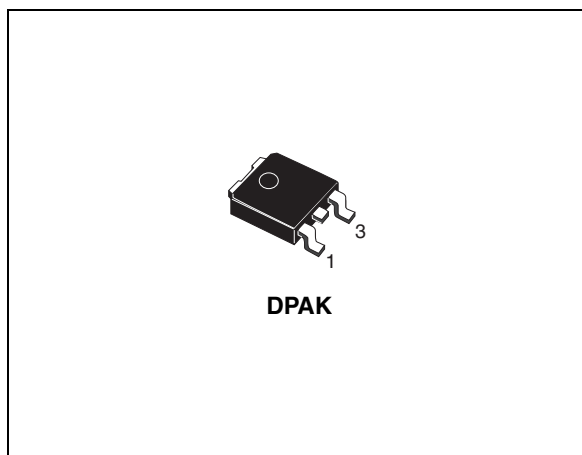

## Internal schematic diagram

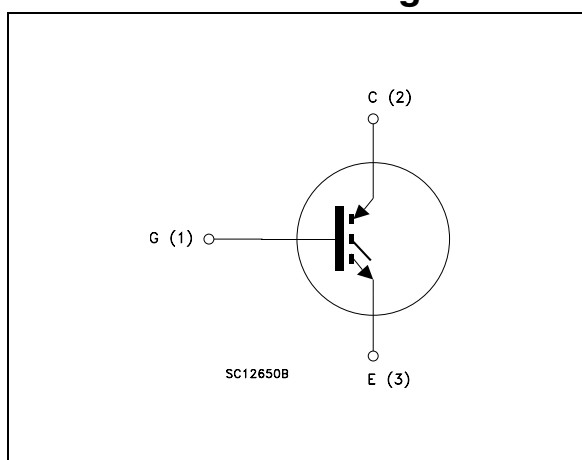

## Order code

| Part number | Marking   | Package | Packaging   |
|-------------|-----------|---------|-------------|
| STGD10NC60H | GD10NC60H | DPAK    | Tape & reel |

# Contents

|          |   |           |
|----------|---|-----------|
| <b>1</b> | <b>Electrical ratings</b> .....           | <b>3</b>  |
| <b>2</b> | <b>Electrical characteristics</b> .....   | <b>4</b>  |
| 2.1      | Electrical characteristics (curves) ..... | 6         |
| <b>3</b> | <b>Test circuits</b> .....                | <b>9</b>  |
| <b>4</b> | <b>Package mechanical data</b> .....      | <b>10</b> |
| <b>5</b> | <b>Packaging mechanical data</b> .....    | <b>12</b> |
| <b>6</b> | <b>Revision history</b> .....             | <b>13</b> |

# 1 Electrical ratings

**Table 1. Absolute maximum ratings**

| Symbol         | Parameter   | Value       | Unit             |
|----------------|---|-------------|------------------|
| $V_{CES}$      | Collector-emitter voltage ( $V_{GS} = 0$ )                  | 600         | V                |
| $I_C^{(1)}$    | Collector current (continuous) at $T_C = 25^\circ\text{C}$  | 20          | A                |
| $I_C^{(1)}$    | Collector current (continuous) at $T_C = 100^\circ\text{C}$ | 10          | A                |
| $I_{CL}^{(2)}$ | Collector current (pulsed)                                  | 40          | A                |
| $V_{GE}$       | Gate-emitter voltage  | $\pm 20$    | V                |
| $P_{TOT}$      | Total dissipation at $T_C = 25^\circ\text{C}$               | 60          | W                |
| $T_j$          | Operating junction temperature                              | - 55 to 150 | $^\circ\text{C}$ |

1. Calculated according to the iterative formula:

$$I_C(T_C) = \frac{T_{JMAX} - T_C}{R_{THJ-C} \times V_{CESAT(MAX)}(T_C, I_C)}$$

2.  $V_{clamp}=480\text{V}$ ,  $T_j=150^\circ\text{C}$ ,  $R_G=10\Omega$ ,  $V_{GE}=15\text{V}$

**Table 2. Thermal resistance**

| Symbol    | Parameter                               | Value | Unit                      |
|-----------|---|-------|---------------------------|
| Rthj-case | Thermal resistance junction-case max    | 2.08  | $^\circ\text{C}/\text{W}$ |
| Rthj-amb  | Thermal resistance junction-ambient max | 62.5  | $^\circ\text{C}/\text{W}$ |

## 2 Electrical characteristics

( $T_{CASE}=25^{\circ}\text{C}$  unless otherwise specified)

**Table 3. Static**

| Symbol        | Parameter                                     | Test conditions   | Min. | Typ.       | Max.      | Unit                |
|---------------|---|---|------|------------|-----------|---------------------|
| $V_{BR(CES)}$ | Collector-emitter breakdown voltage           | $I_C = 1\text{mA}, V_{GE} = 0$  | 600  |            |           | V                   |
| $I_{CES}$     | Collector cut-off current ( $V_{GE} = 0$ )    | $V_{CE} = \text{Max rating}, T_C = 25^{\circ}\text{C}$<br>$V_{CE} = \text{Max rating}, T_C = 125^{\circ}\text{C}$ |      |            | 150<br>1  | $\mu\text{A}$<br>mA |
| $I_{GES}$     | Gate-emitter leakage current ( $V_{CE} = 0$ ) | $V_{GE} = \pm 20\text{V}, V_{CE} = 0$   |      |            | $\pm 100$ | nA                  |
| $V_{GE(th)}$  | Gate threshold voltage                        | $V_{CE} = V_{GE}, I_C = 250\ \mu\text{A}$   | 3.75 |            | 5.75      | V                   |
| $V_{CE(sat)}$ | Collector-emitter saturation voltage          | $V_{GE} = 15\text{V}, I_C = 5\text{A}$<br>$V_{GE} = 15\text{V}, I_C = 5\text{A}, T_C = 125^{\circ}\text{C}$       |      | 1.9<br>1.7 | 2.5       | V<br>V              |
| $g_{fs}$      | Forward transconductance                      | $V_{CE} = 15\text{V}, I_C = 5\text{A}$  |      | 3.5        |           | S                   |

**Table 4. Dynamic**

| Symbol    | Parameter                    | Test conditions   | Min. | Typ. | Max. | Unit |
|-----------|------------------------------|---|------|------|------|------|
| $C_{ies}$ | Input capacitance            | $V_{CE} = 25\text{V}, f = 1\text{MHz},$<br>$V_{GE} = 0$ |      | 365  |      | pF   |
| $C_{oes}$ | Output capacitance           |   |      | 43   |      | pF   |
| $C_{res}$ | Reverse transfer capacitance |   |      | 8.3  |      | pF   |
| $Q_g$     | Total gate charge            | $V_{CE} = 390\text{V}, I_C = 5\text{A},$                |      | 19.2 |      | nC   |
| $Q_{ge}$  | Gate-emitter charge          | $V_{GE} = 15\text{V},$                                  |      | 4.5  |      | nC   |
| $Q_{gc}$  | Gate-collector charge        | (see Figure 16)   |      | 7    |      | nC   |

**Table 5. Switching on/off (inductive load)**

| Symbol                                  | Parameter   | Test conditions   | Min. | Typ.              | Max. | Unit                   |
|---|---|---|------|-------------------|------|------------------------|
| $t_{d(on)}$<br>$t_r$<br>$(di/dt)_{on}$  | Turn-on delay time<br>Current rise time<br>Turn-on current slope  | $V_{CC} = 390V, I_C = 5A$<br>$R_G = 10\Omega, V_{GE} = 15V,$<br><i>Figure 15. Figure 17.</i>                            |      | 14.2<br>5<br>1000 |      | ns<br>ns<br>A/ $\mu$ s |
| $t_{d(on)}$<br>$t_r$<br>$(di/dt)_{on}$  | Turn-on delay time<br>Current rise time<br>Turn-on current slope  | $V_{CC} = 390V, I_C = 5A$<br>$R_G = 10\Omega, V_{GE} = 15V,$<br>$T_j = 125^\circ C$<br><i>Figure 15. Figure 17.</i>     |      | 14<br>5<br>920    |      | ns<br>ns<br>A/ $\mu$ s |
| $t_r(V_{off})$<br>$t_{d(off)}$<br>$t_f$ | Off voltage rise time<br>Turn-off delay time<br>Current fall time | $V_{CC} = 390V, I_C = 5A,$<br>$R_{GE} = 10\Omega, V_{GE} = 15V,$<br><i>Figure 15. Figure 17.</i>                        |      | 27<br>72<br>85    |      | ns<br>ns<br>ns         |
| $t_r(V_{off})$<br>$t_{d(off)}$<br>$t_f$ | Off voltage rise time<br>Turn-off delay time<br>Current fall time | $V_{CC} = 390V, I_C = 5A,$<br>$R_{GE} = 10\Omega, V_{GE} = 15V,$<br>$T_j = 125^\circ C$<br><i>Figure 15. Figure 17.</i> |      | 50<br>108<br>139  |      | ns<br>ns<br>ns         |

**Table 6. Switching energy (inductive load)**

| Symbol                                  | Parameter   | Test conditions   | Min. | Typ.                 | Max. | Unit                          |
|---|---|---|------|----------------------|------|-------------------------------|
| $E_{on}$<br>$E_{off}^{(1)}$<br>$E_{ts}$ | Turn-on switching losses<br>Turn-off switching losses<br>Total switching losses | $V_{CC} = 390V, I_C = 5A$<br>$R_G = 10\Omega, V_{GE} = 15V, T_j = 25^\circ C$<br><i>(see Figure 17)</i>       |      | 31.8<br>95<br>126.8  |      | $\mu$ J<br>$\mu$ J<br>$\mu$ J |
| $E_{on}$<br>$E_{off}^{(1)}$<br>$E_{ts}$ | Turn-on switching losses<br>Turn-off switching Losses<br>Total switching losses | $V_{CC} = 390V, I_C = 5A$<br>$R_G = 10\Omega, V_{GE} = 15V,$<br>$T_j = 125^\circ C$<br><i>(see Figure 17)</i> |      | 61.8<br>173<br>234.8 |      | $\mu$ J<br>$\mu$ J<br>$\mu$ J |

1. Turn-off losses include also the tail of the collector current

## 2.1 Electrical characteristics (curves)

Figure 1. Output characteristics

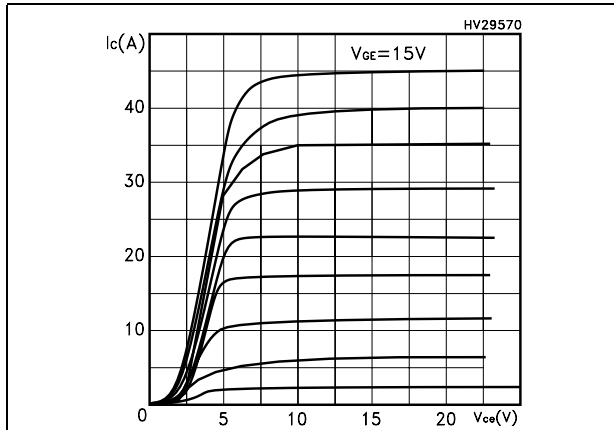

Figure 2. Transfer characteristics

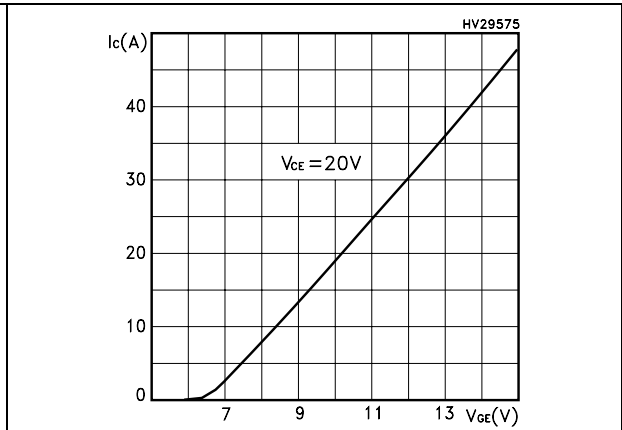

Figure 3. Transconductance

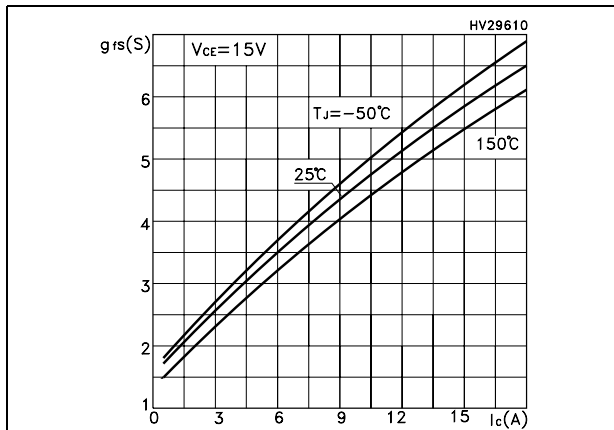

Figure 4. Collector-emitter on voltage vs temperature

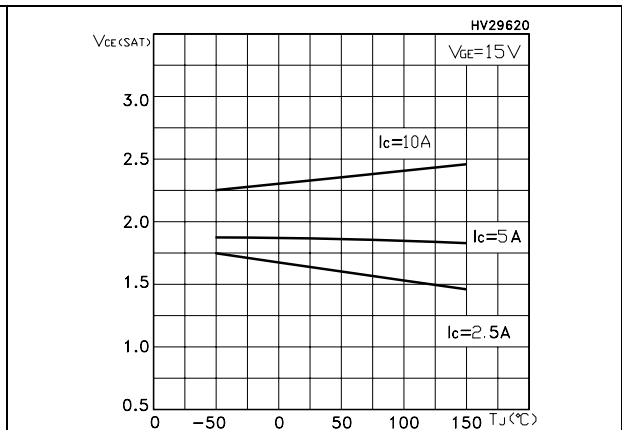

Figure 5. Gate charge vs gate-source voltage

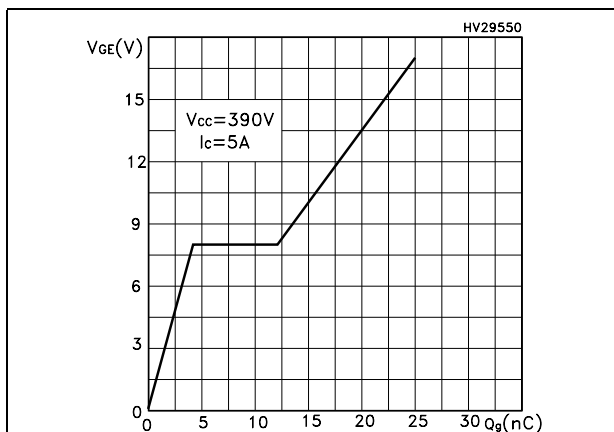

Figure 6. Capacitance variations

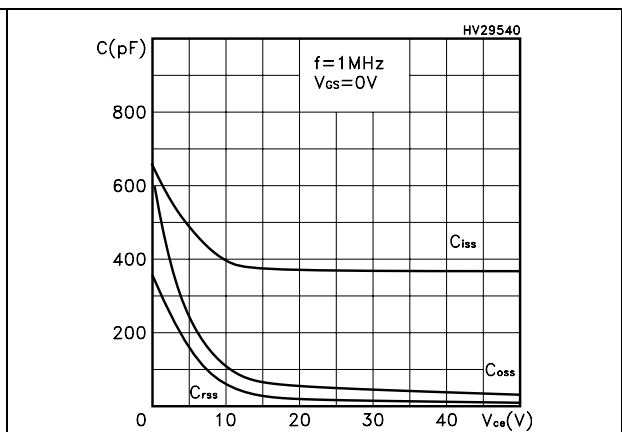

Figure 7. Normalized gate threshold voltage vs temperature

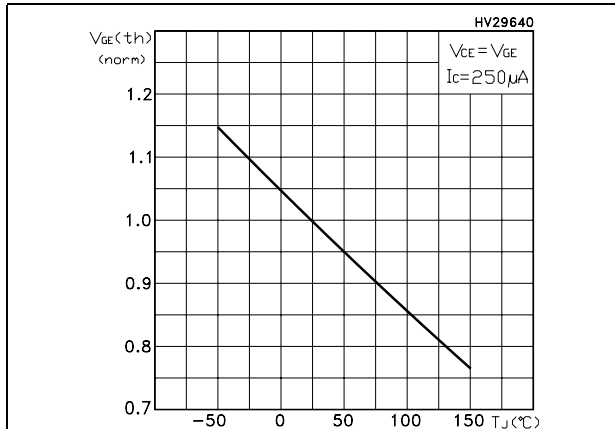

Figure 8. Collector-emitter on voltage vs collector current

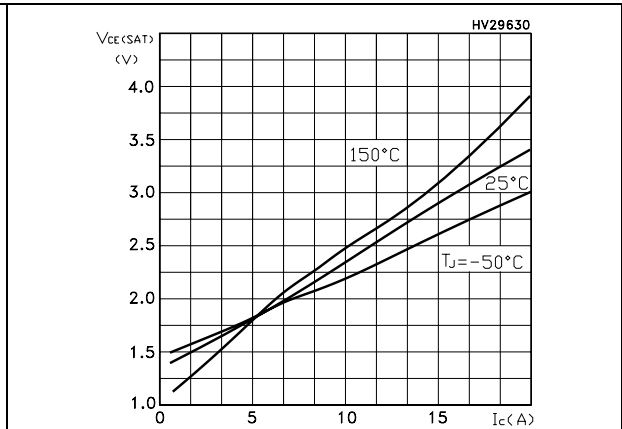

Figure 9. Normalized breakdown voltage vs temperature

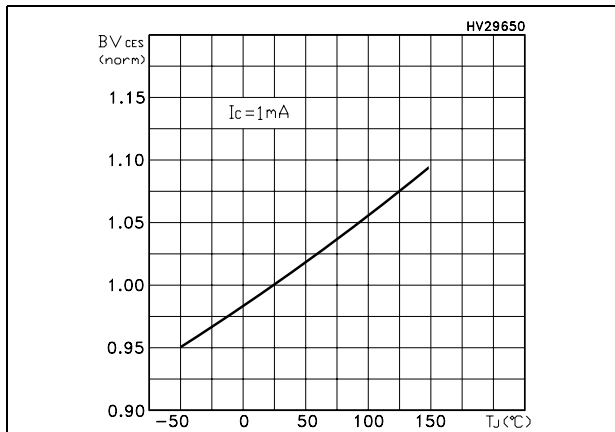

Figure 10. Switching losses vs temperature

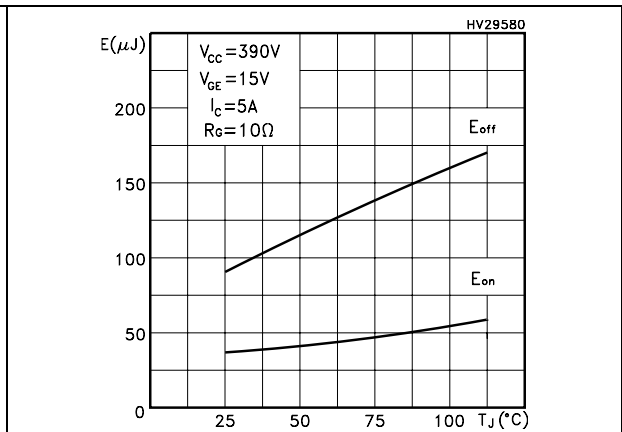

Figure 11. Switching losses vs gate resistance

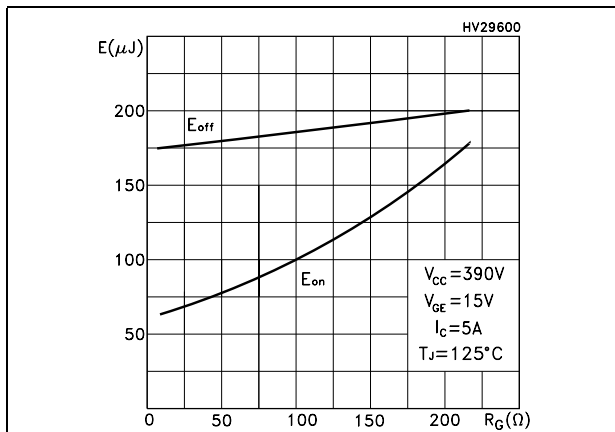

Figure 12. Switching losses vs collector current

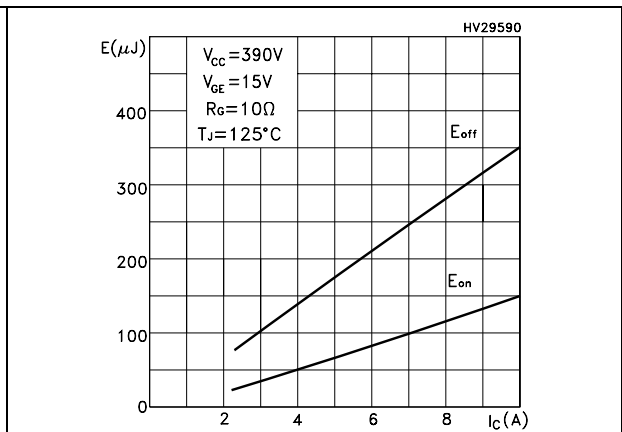

Figure 13. Thermal Impedance

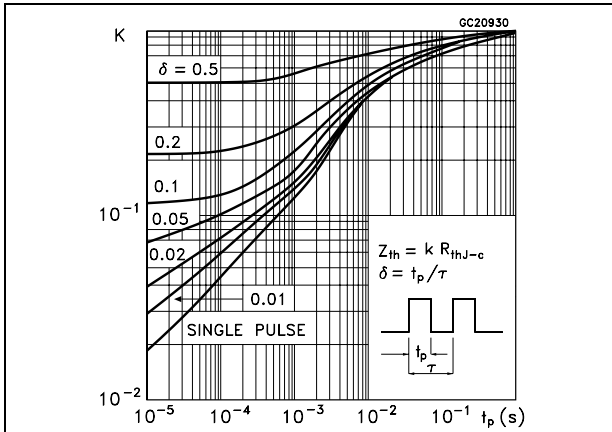
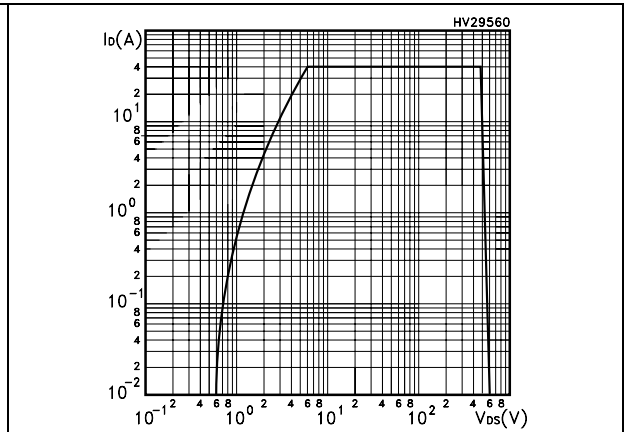

Figure 14. Turn-off SOA





### 3 Test circuits

Figure 15. Test circuit for inductive load switching

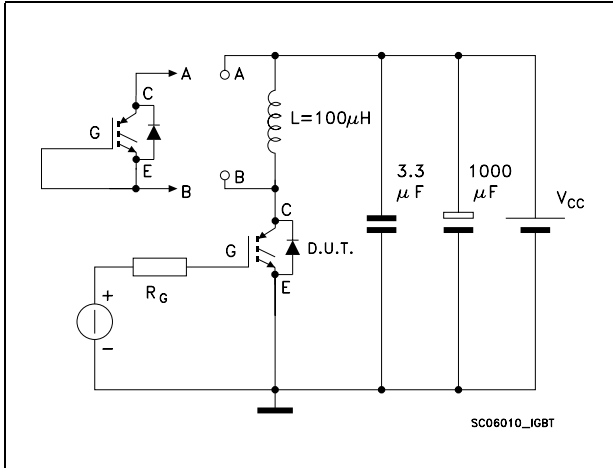

Figure 16. Gate charge test circuit

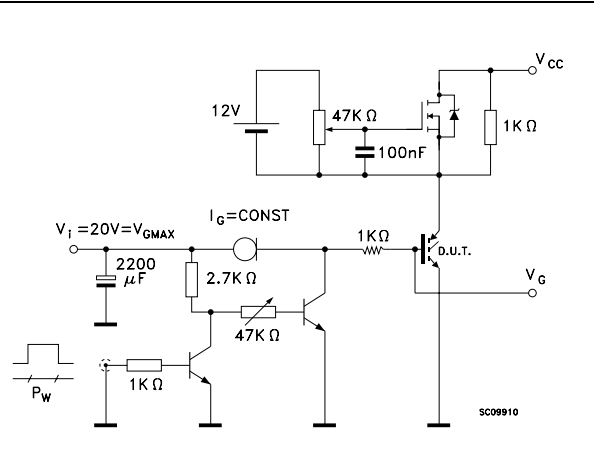
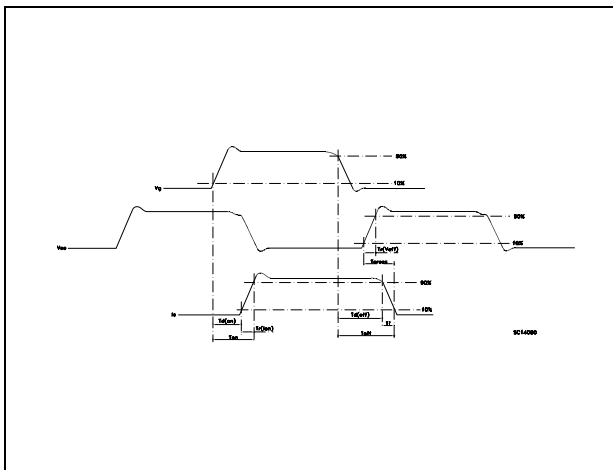

Figure 17. Switching waveform



## 4 Package mechanical data

In order to meet environmental requirements, ST offers these devices in ECOPACK® packages. These packages have a Lead-free second level interconnect. The category of second level interconnect is marked on the package and on the inner box label, in compliance with JEDEC Standard JESD97. The maximum ratings related to soldering conditions are also marked on the inner box label. ECOPACK is an ST trademark. ECOPACK specifications are available at: [www.st.com](http://www.st.com)

**DPAK MECHANICAL DATA**

| DIM. | mm.  |      |      | inch  |       |       |
|------|------|------|------|-------|-------|-------|
|      | MIN. | TYP  | MAX. | MIN.  | TYP.  | MAX.  |
| A    | 2.2  |      | 2.4  | 0.086 |       | 0.094 |
| A1   | 0.9  |      | 1.1  | 0.035 |       | 0.043 |
| A2   | 0.03 |      | 0.23 | 0.001 |       | 0.009 |
| B    | 0.64 |      | 0.9  | 0.025 |       | 0.035 |
| b4   | 5.2  |      | 5.4  | 0.204 |       | 0.212 |
| C    | 0.45 |      | 0.6  | 0.017 |       | 0.023 |
| C2   | 0.48 |      | 0.6  | 0.019 |       | 0.023 |
| D    | 6    |      | 6.2  | 0.236 |       | 0.244 |
| D1   |      | 5.1  |      |       | 0.200 |       |
| E    | 6.4  |      | 6.6  | 0.252 |       | 0.260 |
| E1   |      | 4.7  |      |       | 0.185 |       |
| e    |      | 2.28 |      |       | 0.090 |       |
| e1   | 4.4  |      | 4.6  | 0.173 |       | 0.181 |
| H    | 9.35 |      | 10.1 | 0.368 |       | 0.397 |
| L    | 1    |      |      | 0.039 |       |       |
| (L1) |      | 2.8  |      |       | 0.110 |       |
| L2   |      | 0.8  |      |       | 0.031 |       |
| L4   | 0.6  |      | 1    | 0.023 |       | 0.039 |
| R    |      | 0.2  |      |       | 0.008 |       |
| V2   | 0°   |      | 8°   | 0°    |       | 8°    |

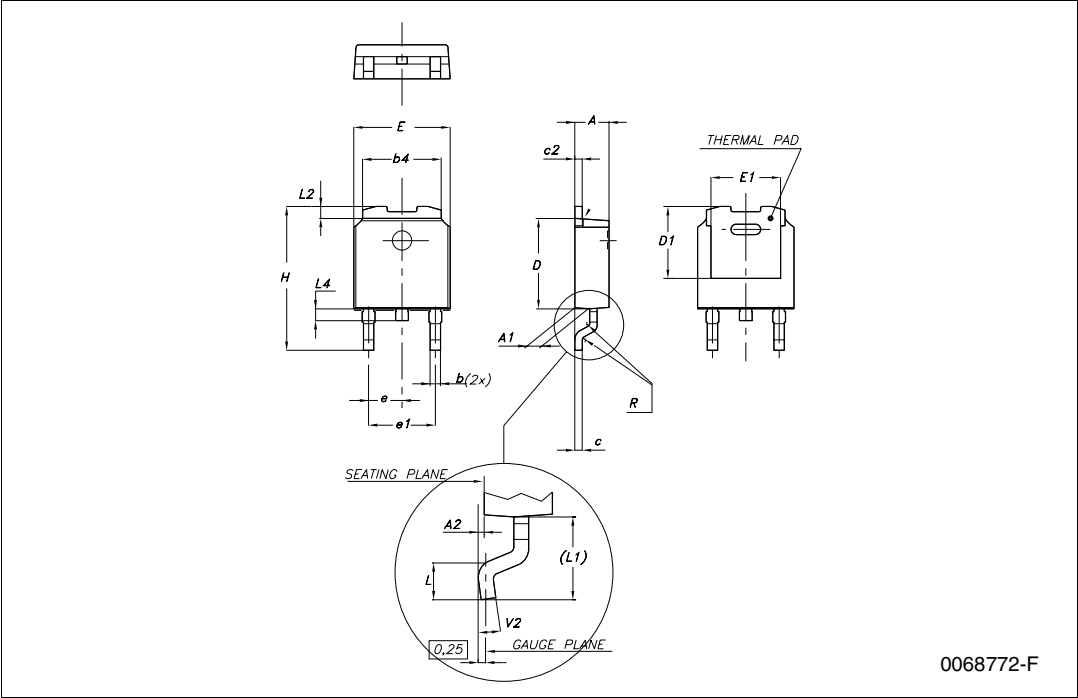

0068772-F

# 5 Packaging mechanical data

## DPAK FOOTPRINT

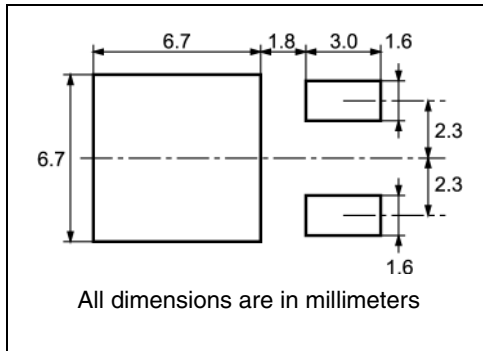

## TAPE AND REEL SHIPMENT

40 mm min. Access hole at slot location

Tape slot in core for tape start 2.5mm min. width

Full radius

G measured at hub

| DIM. | mm   |      | inch  |        |
|------|------|------|-------|--------|
|      | MIN. | MAX. | MIN.  | MAX.   |
| A    |      | 330  |       | 12.992 |
| B    | 1.5  |      | 0.059 |        |
| C    | 12.8 | 13.2 | 0.504 | 0.520  |
| D    | 20.2 |      | 0.795 |        |
| G    | 16.4 | 18.4 | 0.645 | 0.724  |
| N    | 50   |      | 1.968 |        |
| T    |      | 22.4 |       | 0.881  |

| BASE QTY | BULK QTY |
|----------|----------|
| 2500     | 2500     |

| DIM. | mm   |      | inch  |       |
|------|------|------|-------|-------|
|      | MIN. | MAX. | MIN.  | MAX.  |
| A0   | 6.8  | 7    | 0.267 | 0.275 |
| B0   | 10.4 | 10.6 | 0.409 | 0.417 |
| B1   |      | 12.1 |       | 0.476 |
| D    | 1.5  | 1.6  | 0.059 | 0.063 |
| D1   | 1.5  |      | 0.059 |       |
| E    | 1.65 | 1.85 | 0.065 | 0.073 |
| F    | 7.4  | 7.6  | 0.291 | 0.299 |
| K0   | 2.55 | 2.75 | 0.100 | 0.108 |
| P0   | 3.9  | 4.1  | 0.153 | 0.161 |
| P1   | 7.9  | 8.1  | 0.311 | 0.319 |
| P2   | 1.9  | 2.1  | 0.075 | 0.082 |
| R    | 40   |      | 1.574 |       |
| W    | 15.7 | 16.3 | 0.618 | 0.641 |

TOP COVER TAPE

10 pitches cumulative tolerance on tape +/- 0.2 mm

Center line of cavity

User Direction of Feed

Bending radius R min.

FEED DIRECTION

For machine ref. only including draft and radii concentric around B0

## 6 Revision history

Table 7. Revision history

| Date        | Revision | Changes          |
|-------------|----------|------------------|
| 02-Apr-2007 | 1        | Initial release. |

**Please Read Carefully:**

Information in this document is provided solely in connection with ST products. STMicroelectronics NV and its subsidiaries ("ST") reserve the right to make changes, corrections, modifications or improvements, to this document, and the products and services described herein at any time, without notice.

All ST products are sold pursuant to ST's terms and conditions of sale.

Purchasers are solely responsible for the choice, selection and use of the ST products and services described herein, and ST assumes no liability whatsoever relating to the choice, selection or use of the ST products and services described herein.

No license, express or implied, by estoppel or otherwise, to any intellectual property rights is granted under this document. If any part of this document refers to any third party products or services it shall not be deemed a license grant by ST for the use of such third party products or services, or any intellectual property contained therein or considered as a warranty covering the use in any manner whatsoever of such third party products or services or any intellectual property contained therein.

**UNLESS OTHERWISE SET FORTH IN ST'S TERMS AND CONDITIONS OF SALE ST DISCLAIMS ANY EXPRESS OR IMPLIED WARRANTY WITH RESPECT TO THE USE AND/OR SALE OF ST PRODUCTS INCLUDING WITHOUT LIMITATION IMPLIED WARRANTIES OF MERCHANTABILITY, FITNESS FOR A PARTICULAR PURPOSE (AND THEIR EQUIVALENTS UNDER THE LAWS OF ANY JURISDICTION), OR INFRINGEMENT OF ANY PATENT, COPYRIGHT OR OTHER INTELLECTUAL PROPERTY RIGHT.**

**UNLESS EXPRESSLY APPROVED IN WRITING BY AN AUTHORIZED ST REPRESENTATIVE, ST PRODUCTS ARE NOT RECOMMENDED, AUTHORIZED OR WARRANTED FOR USE IN MILITARY, AIR CRAFT, SPACE, LIFE SAVING, OR LIFE SUSTAINING APPLICATIONS, NOR IN PRODUCTS OR SYSTEMS WHERE FAILURE OR MALFUNCTION MAY RESULT IN PERSONAL INJURY, DEATH, OR SEVERE PROPERTY OR ENVIRONMENTAL DAMAGE. ST PRODUCTS WHICH ARE NOT SPECIFIED AS "AUTOMOTIVE GRADE" MAY ONLY BE USED IN AUTOMOTIVE APPLICATIONS AT USER'S OWN RISK.**

Resale of ST products with provisions different from the statements and/or technical features set forth in this document shall immediately void any warranty granted by ST for the ST product or service described herein and shall not create or extend in any manner whatsoever, any liability of ST.

ST and the ST logo are trademarks or registered trademarks of ST in various countries.

Information in this document supersedes and replaces all information previously supplied.

The ST logo is a registered trademark of STMicroelectronics. All other names are the property of their respective owners.

© 2007 STMicroelectronics - All rights reserved

STMicroelectronics group of companies

Australia - Belgium - Brazil - Canada - China - Czech Republic - Finland - France - Germany - Hong Kong - India - Israel - Italy - Japan - Malaysia - Malta - Morocco - Singapore - Spain - Sweden - Switzerland - United Kingdom - United States of America

[www.st.com](http://www.st.com)