



# STGB8NC60K - STGD8NC60K STGP8NC60K

N-channel 600V - 8A - D<sup>2</sup>PAK / DPAK / TO-220  
Short circuit rated PowerMESH™ IGBT

## Features

Type	V <sub>CES</sub>	V <sub>CE(sat)</sub> Typ @25°C	I <sub>C</sub> @100°C
STGB8NC60K	600V	2.2V	8A
STGD8NC60K	600V	2.2V	8A
STGP8NC60K	600V	2.2V	8A

- Lower on voltage drop (V<sub>cesat</sub>)
- Lower C<sub>RES</sub> / C<sub>IES</sub> ratio (no cross-conduction susceptibility)
- Very soft ultra fast recovery antiparallel diode
- Short circuit withstand time 10μs

## Applications

- High frequency motor controls
- SMPS and PFC in both hard switch and resonant topologies
- Motor drivers

## Description

Using the latest high voltage technology based on a patented strip layout, STMicroelectronics has designed an advanced family of IGBTs, the PowerMESH™ IGBTs, with outstanding performances. The suffix "K" identifies a family optimized for high frequency motor control applications with short circuit withstand capability.

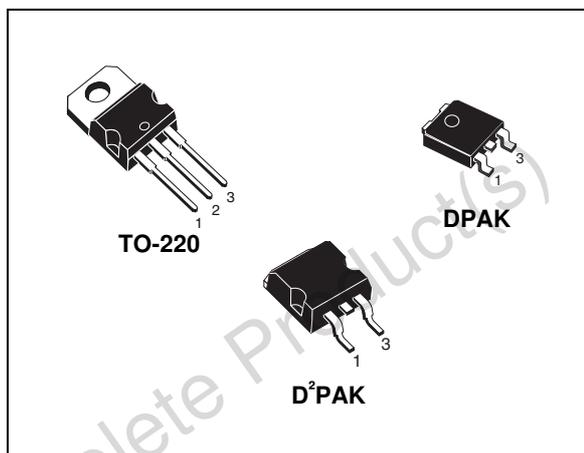

Figure 1. Internal schematic diagram

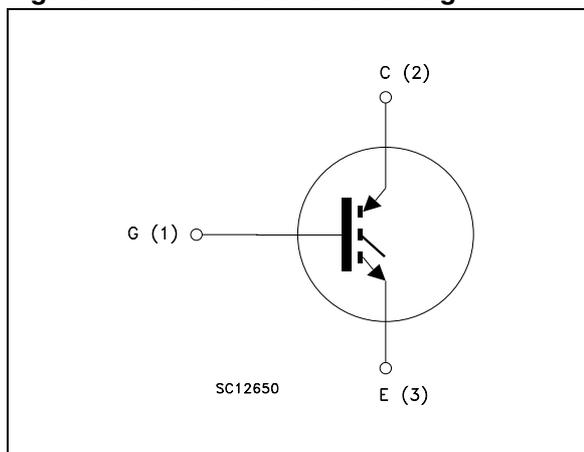

Table 1. Device summary

Order codes	Marking	Package	Packaging
STGB8NC60K	GB8NC60K	D <sup>2</sup> PAK	Tape & reel
STGD8NC60K	GD8NC60K	DPAK	Tape & reel
STGP8NC60K	GP8NC60K	TO-220	Tube

# Contents

<b>1</b>	<b>Electrical ratings</b> .....	<b>3</b>
<b>2</b>	<b>Electrical characteristics</b> .....	<b>4</b>
2.1	Electrical characteristics (curves) .....	6
<b>3</b>	<b>Test circuit</b> .....	<b>9</b>
<b>4</b>	<b>Package mechanical data</b> .....	<b>10</b>
<b>5</b>	<b>Packaging mechanical data</b> .....	<b>14</b>
<b>6</b>	<b>Revision history</b> .....	<b>16</b>

Obsolete Product(s) - Obsolete Product(s)

# 1 Electrical ratings

**Table 2. Absolute maximum ratings**

Symbol	Parameter	Value		Unit
		D <sup>2</sup> PAK/TO-220	DPAK	
V <sub>CES</sub>	Collector-emitter voltage (V <sub>GS</sub> = 0)	600		V
I <sub>C</sub> <sup>(1)</sup>	Collector current (continuous) at T <sub>C</sub> = 25°C	15		A
I <sub>C</sub> <sup>(1)</sup>	Collector current (continuous) at T <sub>C</sub> = 100°C	8		A
I <sub>CP</sub> <sup>(2)</sup>	Pulsed collector current	30		A
V <sub>GE</sub>	Gate-emitter voltage	±20		V
P <sub>TOT</sub>	Total dissipation at T <sub>C</sub> = 25°C	65	62	W
T <sub>j</sub>	Operating junction temperature	– 55 to 150		°C
T <sub>scw</sub>	Short circuit withstand time	10		µs

1. Calculated according to the iterative formula:

$$I_C(T_C) = \frac{T_{JMAX} - T_C}{R_{THJ-C} \times V_{CESAT(MAX)}(T_C, I_C)}$$

2. Pulse width limited by max junction temperature

**Table 3. Thermal resistance**

Symbol	Parameter		Value	Unit
R <sub>thj-case</sub>	Thermal resistance junction-case max	TO-220 / D <sup>2</sup> PAK	1.9	°C/W
		DPAK	2.0	°C/W
R <sub>thj-amb</sub>	Thermal resistance junction-ambient Max		62.5	°C/W

## 2 Electrical characteristics

( $T_{CASE}=25^{\circ}\text{C}$  unless otherwise specified)

**Table 4. Static**

Symbol	Parameter	Test conditions	Min.	Typ.	Max.	Unit
$V_{BR(CES)}$	Collector-emitter breakdown voltage	$I_C = 1\text{mA}, V_{GE} = 0$	600			V
$V_{CE(sat)}$	Collector-emitter saturation voltage	$V_{GE} = 15\text{V}, I_C = 3\text{A}$ $V_{GE} = 15\text{V}, I_C = 3\text{A}, T_C = 125^{\circ}\text{C}$		2.2 1.8	2.75	V V
$V_{GE(th)}$	Gate threshold voltage	$V_{CE} = V_{GE}, I_C = 250\ \mu\text{A}$	4.5		6.5	V
$I_{CES}$	Collector cut-off current ( $V_{GE} = 0$ )	$V_{CE} = \text{Max rating}, T_C = 25^{\circ}\text{C}$ $V_{CE} = \text{Max rating}, T_C = 125^{\circ}\text{C}$			150 1	$\mu\text{A}$ mA
$I_{GES}$	Gate-emitter leakage current ( $V_{CE} = 0$ )	$V_{GE} = \pm 20\text{V}, V_{CE} = 0$			$\pm 100$	nA
$g_{fs}$	Forward transconductance	$V_{CE} = 15\text{V}, I_C = 3\text{A}$		15		S

**Table 5. Dynamic**

Symbol	Parameter	Test conditions	Min.	Typ.	Max.	Unit
$C_{ies}$	Input capacitance	$V_{CE} = 25\text{V}, f = 1\text{MHz},$ $V_{GE} = 0$		380		pF
$C_{oes}$	Output capacitance			46		pF
$C_{res}$	Reverse transfer capacitance			8.5		pF
$Q_g$	Total gate charge	$V_{CE} = 390\text{V}, I_C = 3\text{A},$		19		nC
$Q_{ge}$	Gate-emitter charge	$V_{GE} = 15\text{V},$		5		nC
$Q_{gc}$	Gate-collector charge	(see Figure 18)		9		nC

**Table 6. Switching on/off (inductive load)**

Symbol	Parameter	Test conditions	Min.	Typ.	Max.	Unit
$t_{d(on)}$ $t_r$ $(di/dt)_{on}$	Turn-on delay time Current rise time Turn-on current slope	$V_{CC} = 390V, I_C = 3A$ $R_G = 10\Omega, V_{GE} = 15V,$ $T_J = 25^\circ C$ <i>(see Figure 19)</i>		17 6 655		ns ns A/ $\mu s$
$t_{d(on)}$ $t_r$ $(di/dt)_{on}$	Turn-on delay time Current rise time Turn-on current slope	$V_{CC} = 390V, I_C = 3A$ $R_G = 10\Omega, V_{GE} = 15V,$ $T_J = 125^\circ C$ <i>(see Figure 19)</i>		16.5 6.5 575		ns ns A/ $\mu s$
$t_r(V_{off})$ $t_{d(off)}$ $t_f$	Off voltage rise time Turn-off delay time Current fall time	$V_{CC} = 390V, I_C = 3A,$ $R_{GE} = 10\Omega, V_{GE} = 15V,$ $T_J = 25^\circ C$ <i>(see Figure 19)</i>		33 72 82		ns ns ns
$t_r(V_{off})$ $t_{d(off)}$ $t_f$	Off voltage rise time Turn-off delay time Current fall time	$V_{CC} = 390V, I_C = 3A,$ $R_{GE} = 10\Omega, V_{GE} = 15V,$ $T_J = 125^\circ C$ <i>(see Figure 19)</i>		60 106 136		ns ns ns

**Table 7. Switching energy (inductive load)**

Symbol	Parameter	Test conditions	Min.	Typ.	Max.	Unit
$E_{on}^{(1)}$ $E_{off}^{(2)}$ $E_{ts}$	Turn-on switching losses Turn-off switching losses Total switching losses	$V_{CC} = 390V, I_C = 3A$ $R_G = 10\Omega, V_{GE} = 15V, T_J = 25^\circ C$ <i>(see Figure 19)</i>		55 85 140		$\mu J$ $\mu J$ $\mu J$
$E_{on}^{(1)}$ $E_{off}^{(2)}$ $E_{ts}$	Turn-on switching losses Turn-off switching losses Total switching losses	$V_{CC} = 390V, I_C = 3A$ $R_G = 10\Omega, V_{GE} = 15V,$ $T_J = 125^\circ C$ <i>(see Figure 19)</i>		87 162 249		$\mu J$ $\mu J$ $\mu J$

1.  $E_{on}$  is the turn-on losses when a typical diode is used in the test circuit in figure 2. If the IGBT is offered in a package with a co-pak diode, the co-pak diode is used as external diode. IGBTs & Diode are at the same temperature (25°C and 125°C)
2. Turn-off losses include also the tail of the collector current

## 2.1 Electrical characteristics (curves)

Figure 2. Output characteristics

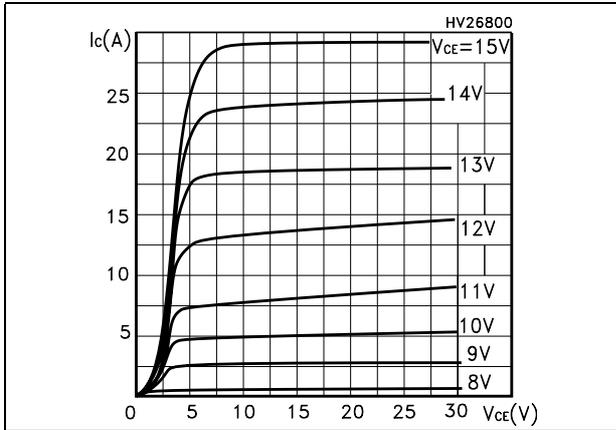

Figure 3. Transfer characteristics

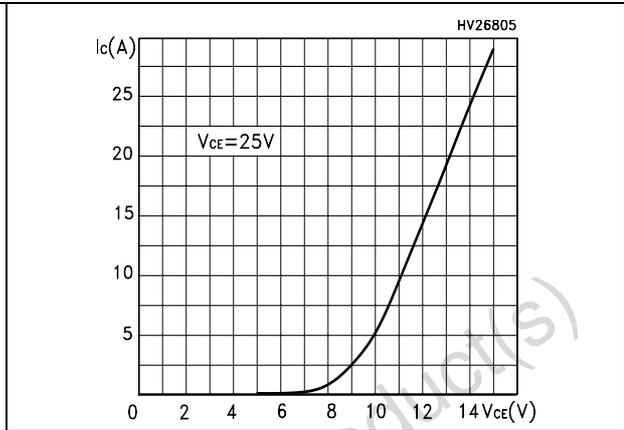

Figure 4. Transconductance

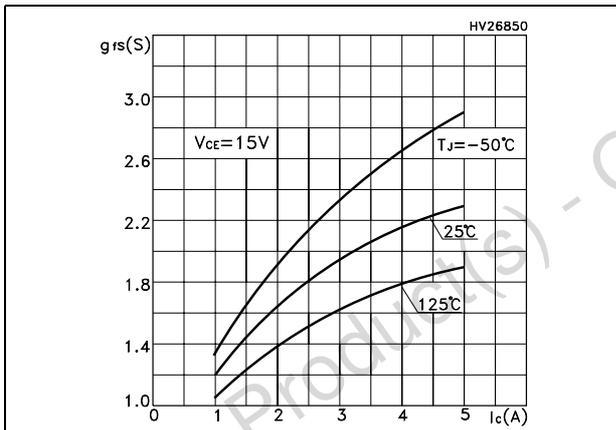

Figure 5. Collector-emitter on voltage vs temperature

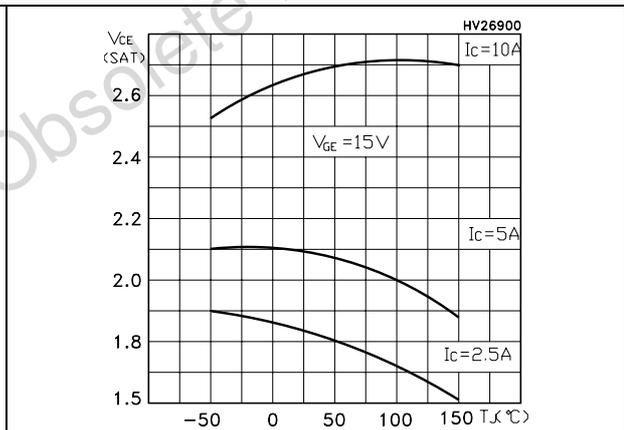

Figure 6. Gate charge vs gate-source voltage Figure 7. Capacitance variations

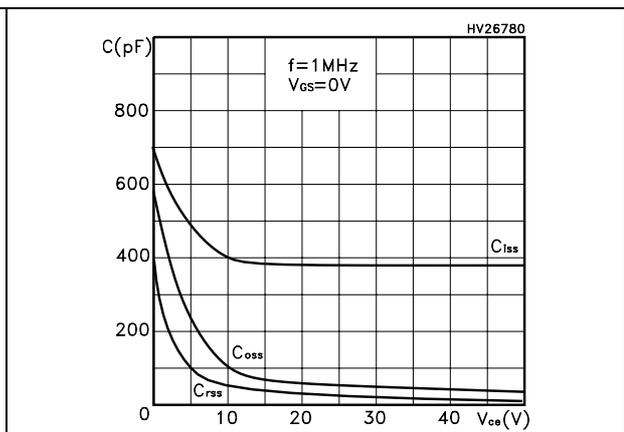
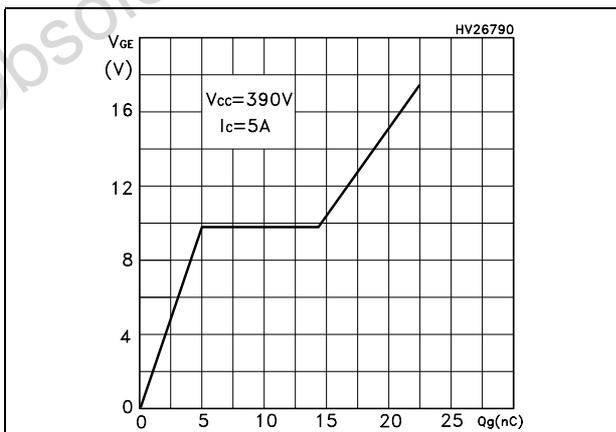

Figure 8. Normalized gate threshold voltage vs temperature

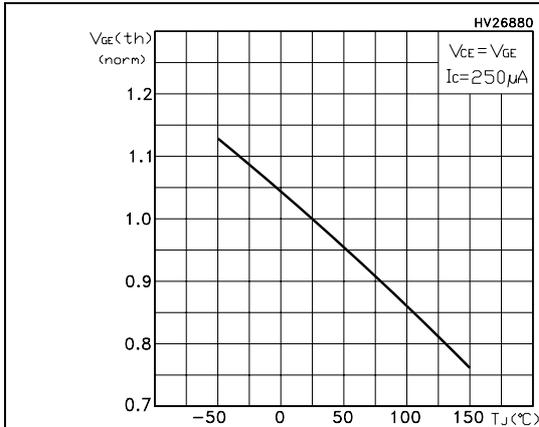

Figure 9. Collector-emitter on voltage vs collector current

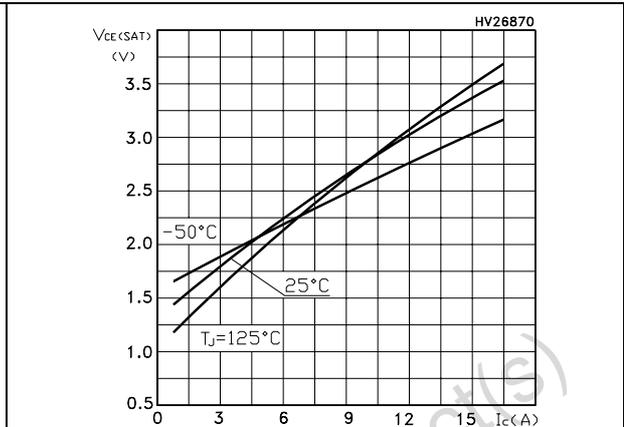

Figure 10. Normalized breakdown voltage vs temperature

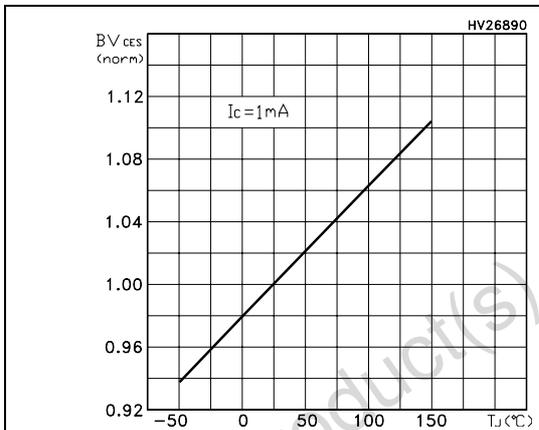

Figure 11. Switching losses vs temperature

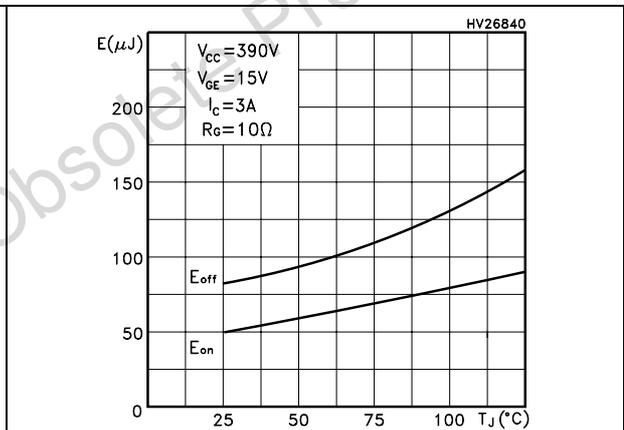

Figure 12. Switching losses vs gate resistance

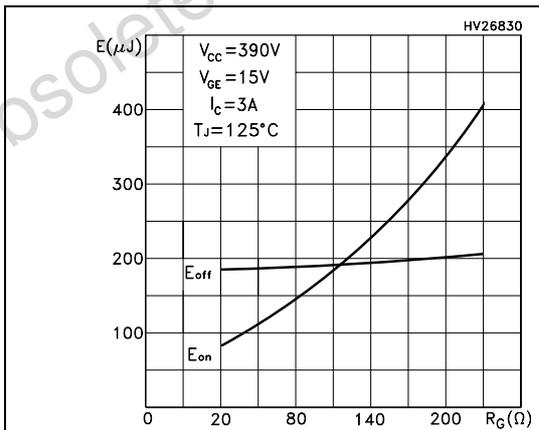

Figure 13. Switching losses vs collector current

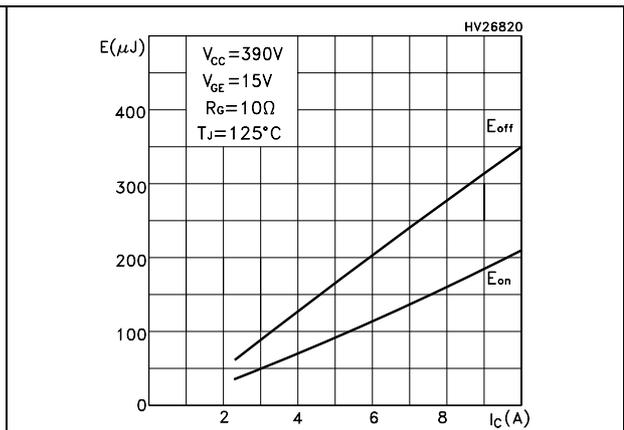

Figure 14. Thermal impedance for TO-220/  
D<sup>2</sup>PAK

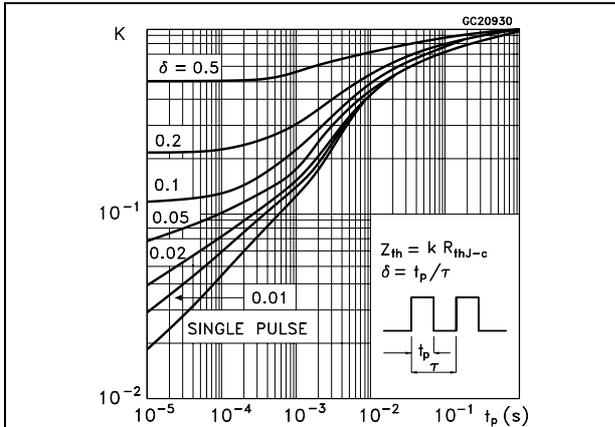

Figure 15. Turn-off SOA

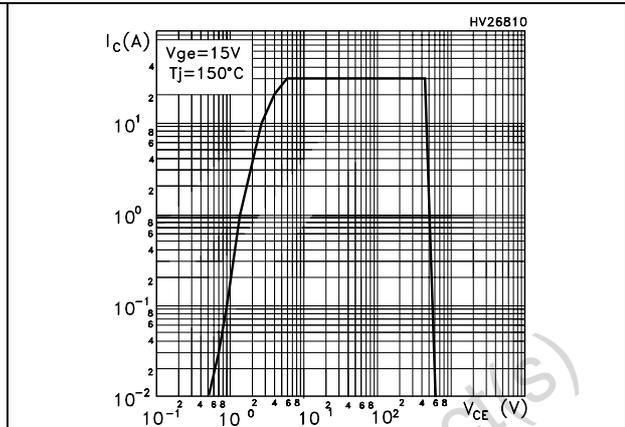
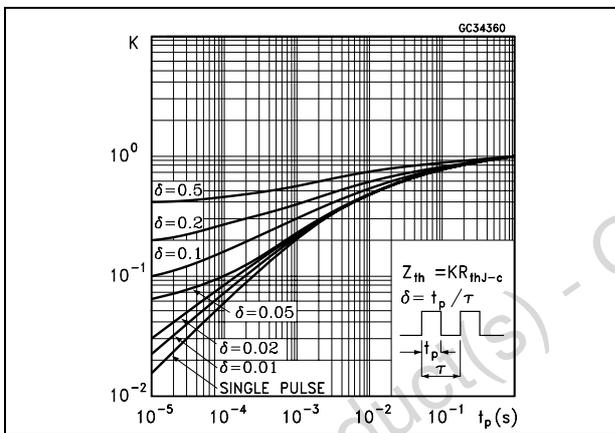

Figure 16. Thermal impedance for DPAK



### 3 Test circuit

Figure 17. Test circuit for inductive load switching

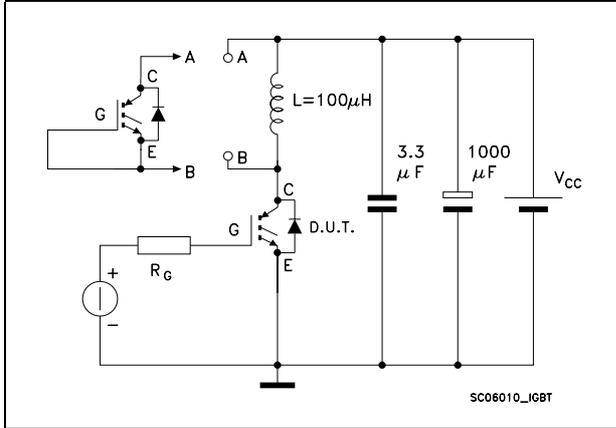

Figure 18. Gate charge test circuit

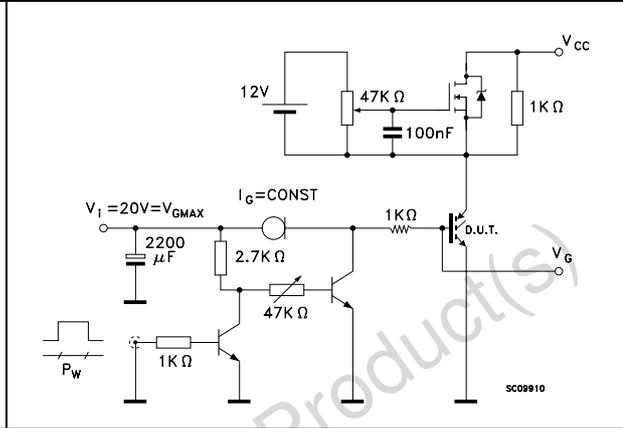

Figure 19. Switching waveform

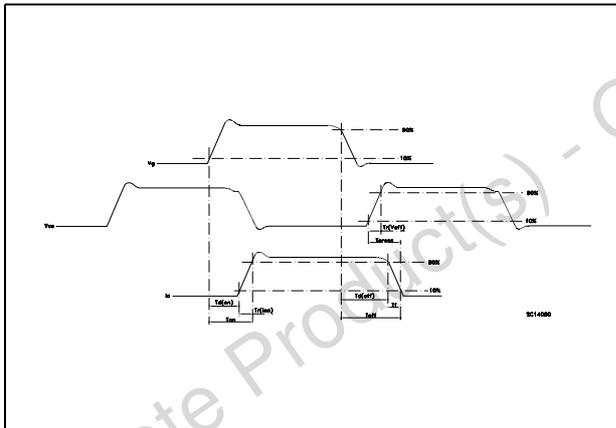
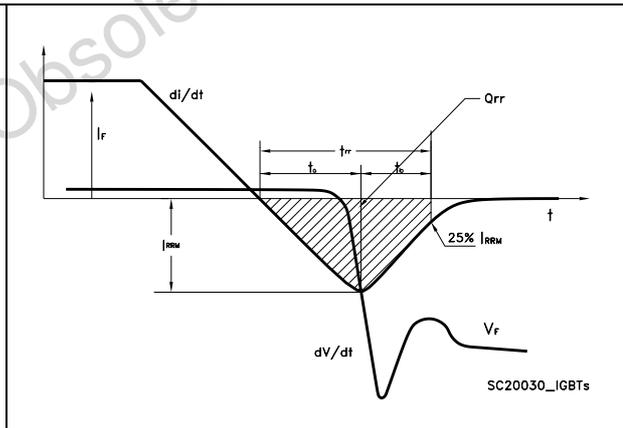

Figure 20. Diode recovery time waveform



## 4 Package mechanical data

In order to meet environmental requirements, ST offers these devices in ECOPACK® packages. These packages have a Lead-free second level interconnect. The category of second level interconnect is marked on the package and on the inner box label, in compliance with JEDEC Standard JESD97. The maximum ratings related to soldering conditions are also marked on the inner box label. ECOPACK is an ST trademark. ECOPACK specifications are available at: [www.st.com](http://www.st.com)

Obsolete Product(s) - Obsolete Product(s)

TO-220 mechanical data

Dim	mm			inch		
	Min	Typ	Max	Min	Typ	Max
A	4.40		4.60	0.173		0.181
b	0.61		0.88	0.024		0.034
b1	1.14		1.70	0.044		0.066
c	0.49		0.70	0.019		0.027
D	15.25		15.75	0.6		0.62
D1		1.27			0.050	
E	10		10.40	0.393		0.409
e	2.40		2.70	0.094		0.106
e1	4.95		5.15	0.194		0.202
F	1.23		1.32	0.048		0.051
H1	6.20		6.60	0.244		0.256
J1	2.40		2.72	0.094		0.107
L	13		14	0.511		0.551
L1	3.50		3.93	0.137		0.154
L20		16.40			0.645	
L30		28.90			1.137	
∅P	3.75		3.85	0.147		0.151
Q	2.65		2.95	0.104		0.116

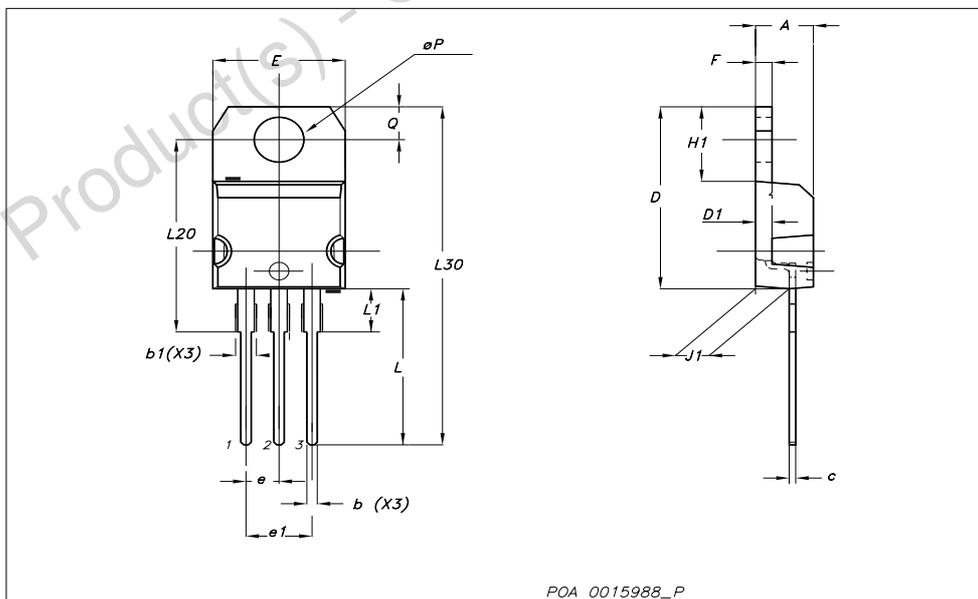

**DPAK MECHANICAL DATA**

DIM.	mm.			inch		
	MIN.	TYP	MAX.	MIN.	TYP.	MAX.
A	2.2		2.4	0.086		0.094
A1	0.9		1.1	0.035		0.043
A2	0.03		0.23	0.001		0.009
B	0.64		0.9	0.025		0.035
b4	5.2		5.4	0.204		0.212
C	0.45		0.6	0.017		0.023
C2	0.48		0.6	0.019		0.023
D	6		6.2	0.236		0.244
D1		5.1			0.200	
E	6.4		6.6	0.252		0.260
E1		4.7			0.185	
e		2.28			0.090	
e1	4.4		4.6	0.173		0.181
H	9.35		10.1	0.368		0.397
L	1			0.039		
(L1)		2.8			0.110	
L2		0.8			0.031	
L4	0.6		1	0.023		0.039
R		0.2			0.008	
V2	0°		8°	0°		8°

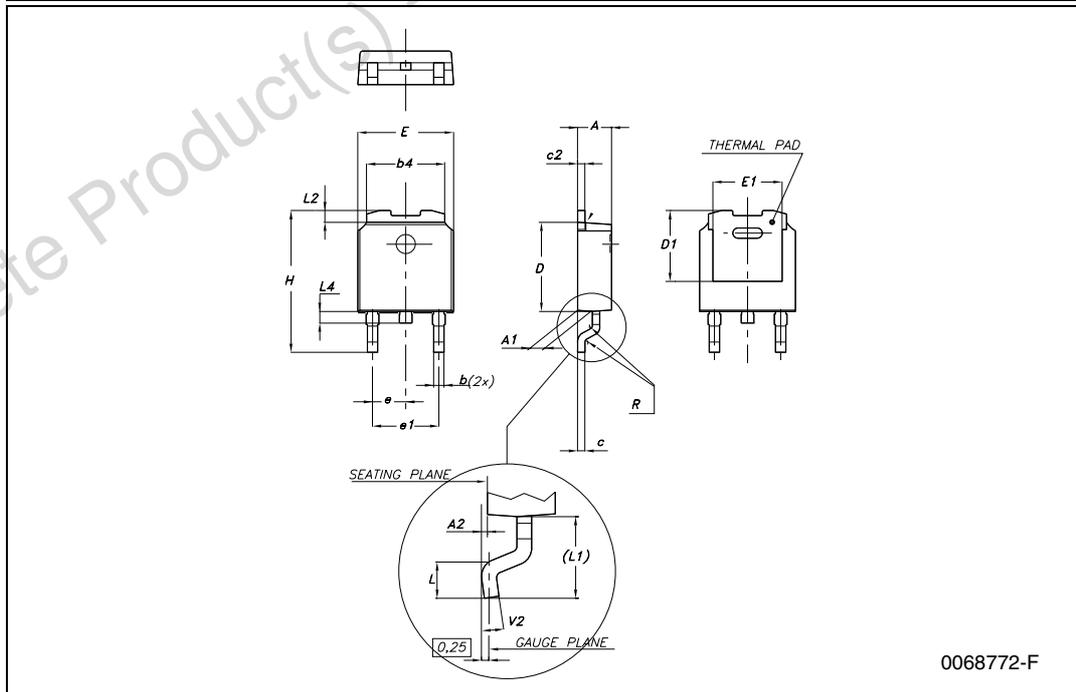

0068772-F

**D<sup>2</sup>PAK mechanical data**

Dim	mm			inch		
	Min	Typ	Max	Min	Typ	Max
A	4.4		4.6	0.173		0.181
A1	2.49		2.69	0.098		0.106
A2	0.03		0.23	0.001		0.009
B	0.7		0.93	0.027		0.036
B2	1.14		1.7	0.044		0.067
C	0.45		0.6	0.017		0.023
C2	1.23		1.36	0.048		0.053
D	8.95		9.35	0.352		0.368
D1		8			0.315	
E	10		10.4	0.393		0.409
E1		8.5			0.334	
G	4.88		5.28	0.192		0.208
L	15		15.85	0.590		0.625
L2	1.27		1.4	0.50		0.55
L3	1.4		1.75	0.055		0.68
M	2.4		3.2	0.094		0.126
R		0.4			0.015	
V2	0°		4°			

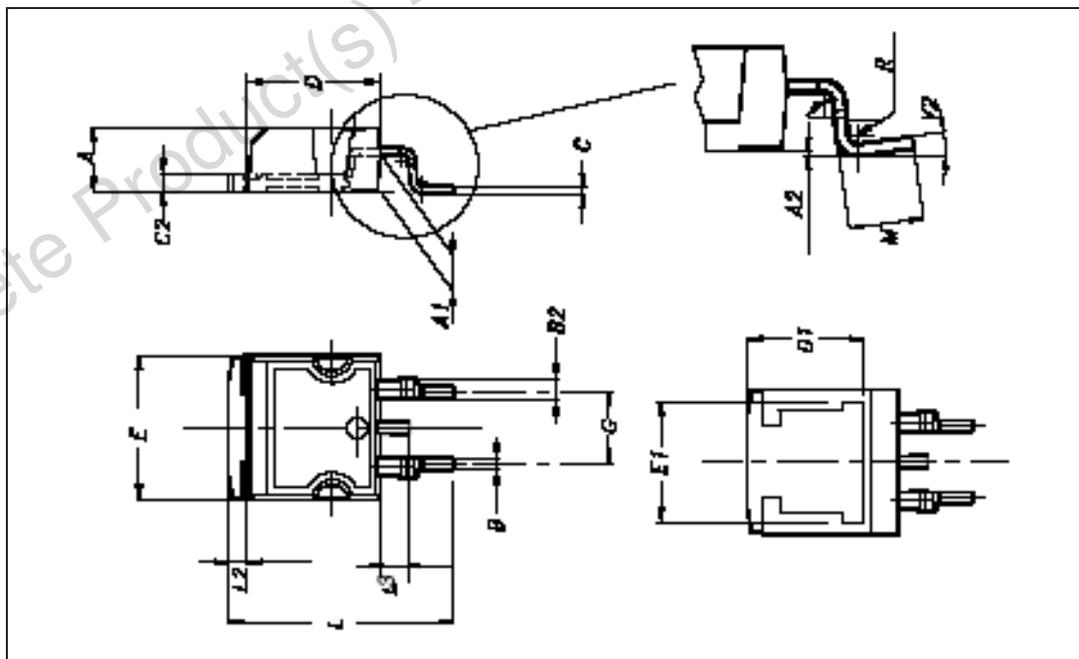

# 5 Packaging mechanical data

## D<sup>2</sup>PAK FOOTPRINT

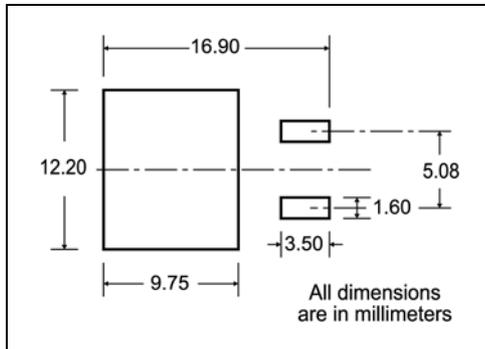

## TAPE AND REEL SHIPMENT

40 mm min. Access hole at slot location

Tape slot in core for tape start 2.5mm min. width

Full radius

G measured at hub

### REEL MECHANICAL DATA

DIM.	mm		inch	
	MIN.	MAX.	MIN.	MAX.
A		330		12.992
B	1.5		0.059	
C	12.8	13.2	0.504	0.520
D	20.2		0.795	
G	24.4	26.4	0.960	1.039
N	100		3.937	
T		30.4		1.197

BASE QTY	BULK QTY
1000	1000

### TAPE MECHANICAL DATA

DIM.	mm		inch	
	MIN.	MAX.	MIN.	MAX.
A0	10.5	10.7	0.413	0.421
B0	15.7	15.9	0.618	0.626
D	1.5	1.6	0.059	0.063
D1	1.59	1.61	0.062	0.063
E	1.65	1.85	0.065	0.073
F	11.4	11.6	0.449	0.456
K0	4.8	5.0	0.189	0.197
P0	3.9	4.1	0.153	0.161
P1	11.9	12.1	0.468	0.476
P2	1.9	2.1	0.075	0.082
R	50		1.574	
T	0.25	0.35	0.0098	0.0137
W	23.7	24.3	0.933	0.956

10 pitches cumulative tolerance on tape +/- 0.2 mm

Center line of cavity

User Direction of Feed

FEED DIRECTION

Bending radius R min.

\* on sales type

**DPAK FOOTPRINT**

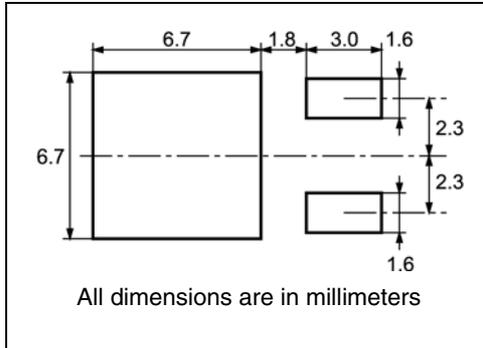

**TAPE AND REEL SHIPMENT**

40 mm min. Access hole at slot location

Full radius

Tape slot in core for tape start 2.5mm min. width

G measured at hub

**REEL MECHANICAL DATA**

DIM.	mm		inch	
	MIN.	MAX.	MIN.	MAX.
A		330		12.992
B	1.5		0.059	
C	12.8	13.2	0.504	0.520
D	20.2		0.795	
G	16.4	18.4	0.645	0.724
N	50		1.968	
T		22.4		0.881

**TAPE MECHANICAL DATA**

DIM.	mm		inch	
	MIN.	MAX.	MIN.	MAX.
A0	6.8	7	0.267	0.275
B0	10.4	10.6	0.409	0.417
B1		12.1		0.476
D	1.5	1.6	0.059	0.063
D1	1.5		0.059	
E	1.65	1.85	0.065	0.073
F	7.4	7.6	0.291	0.299
K0	2.55	2.75	0.100	0.108
P0	3.9	4.1	0.153	0.161
P1	7.9	8.1	0.311	0.319
P2	1.9	2.1	0.075	0.082
R	40		1.574	
W	15.7	16.3	0.618	0.641

**BASE QTY** | **BULK QTY**

2500 | 2500

For machine ref. only including draft and radii concentric around B<sub>0</sub>

10 pitches cumulative tolerance on tape +/- 0.2 mm

User Direction of Feed

FEED DIRECTION

Bending radius R min.

## 6 Revision history

Table 8. Document revision history

Date	Revision	Changes
02-Oct-2007	1	First release

Obsolete Product(s) - Obsolete Product(s)

**Please Read Carefully:**

Information in this document is provided solely in connection with ST products. STMicroelectronics NV and its subsidiaries ("ST") reserve the right to make changes, corrections, modifications or improvements, to this document, and the products and services described herein at any time, without notice.

All ST products are sold pursuant to ST's terms and conditions of sale.

Purchasers are solely responsible for the choice, selection and use of the ST products and services described herein, and ST assumes no liability whatsoever relating to the choice, selection or use of the ST products and services described herein.

No license, express or implied, by estoppel or otherwise, to any intellectual property rights is granted under this document. If any part of this document refers to any third party products or services it shall not be deemed a license grant by ST for the use of such third party products or services, or any intellectual property contained therein or considered as a warranty covering the use in any manner whatsoever of such third party products or services or any intellectual property contained therein.

**UNLESS OTHERWISE SET FORTH IN ST'S TERMS AND CONDITIONS OF SALE ST DISCLAIMS ANY EXPRESS OR IMPLIED WARRANTY WITH RESPECT TO THE USE AND/OR SALE OF ST PRODUCTS INCLUDING WITHOUT LIMITATION IMPLIED WARRANTIES OF MERCHANTABILITY, FITNESS FOR A PARTICULAR PURPOSE (AND THEIR EQUIVALENTS UNDER THE LAWS OF ANY JURISDICTION), OR INFRINGEMENT OF ANY PATENT, COPYRIGHT OR OTHER INTELLECTUAL PROPERTY RIGHT.**

**UNLESS EXPRESSLY APPROVED IN WRITING BY AN AUTHORIZED ST REPRESENTATIVE, ST PRODUCTS ARE NOT RECOMMENDED, AUTHORIZED OR WARRANTED FOR USE IN MILITARY, AIR CRAFT, SPACE, LIFE SAVING, OR LIFE SUSTAINING APPLICATIONS, NOR IN PRODUCTS OR SYSTEMS WHERE FAILURE OR MALFUNCTION MAY RESULT IN PERSONAL INJURY, DEATH, OR SEVERE PROPERTY OR ENVIRONMENTAL DAMAGE. ST PRODUCTS WHICH ARE NOT SPECIFIED AS "AUTOMOTIVE GRADE" MAY ONLY BE USED IN AUTOMOTIVE APPLICATIONS AT USER'S OWN RISK.**

Resale of ST products with provisions different from the statements and/or technical features set forth in this document shall immediately void any warranty granted by ST for the ST product or service described herein and shall not create or extend in any manner whatsoever, any liability of ST.

ST and the ST logo are trademarks or registered trademarks of ST in various countries.

Information in this document supersedes and replaces all information previously supplied.

The ST logo is a registered trademark of STMicroelectronics. All other names are the property of their respective owners.

© 2007 STMicroelectronics - All rights reserved

STMicroelectronics group of companies

Australia - Belgium - Brazil - Canada - China - Czech Republic - Finland - France - Germany - Hong Kong - India - Israel - Italy - Japan - Malaysia - Malta - Morocco - Singapore - Spain - Sweden - Switzerland - United Kingdom - United States of America

[www.st.com](http://www.st.com)