

### Features

- Optimized performance for medium operating frequencies up to 5 kHz in hard switching
- Low on-voltage drop ( $V_{CE(sat)}$ )
- Very soft ultra fast antiparallel diode

### Application

- Motor drive

### Description

This IGBT utilizes the advanced PowerMESH™ process resulting in an excellent trade-off between switching performance and low on-state behavior.

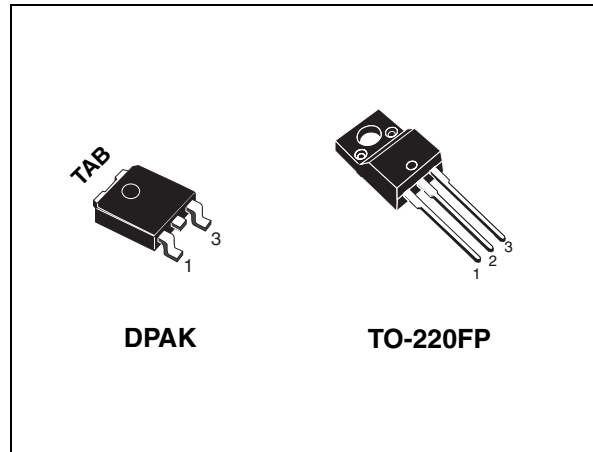

Figure 1. Internal schematic diagram

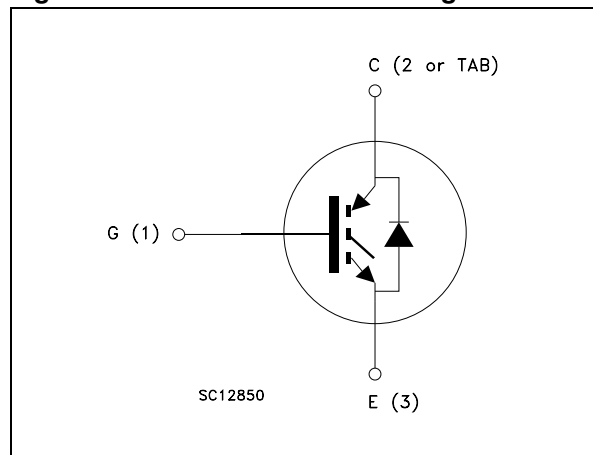

Table 1. Device summary

Order codes	Marking	Package	Packaging
STGD10NC60SDT4	GD10NC60SD	DPAK	Tape and reel
STGF10NC60SD	GF10NC60SD	TO-220FP	Tube

# Contents

<b>1</b>	<b>Electrical ratings</b> .....	<b>3</b>
<b>2</b>	<b>Electrical characteristics</b> .....	<b>4</b>
2.1	Electrical characteristics (curves) .....	6
<b>3</b>	<b>Test circuits</b> .....	<b>9</b>
<b>4</b>	<b>Package mechanical data</b> .....	<b>10</b>
<b>5</b>	<b>Packaging mechanical data</b> .....	<b>14</b>
<b>6</b>	<b>Revision history</b> .....	<b>15</b>

# 1 Electrical ratings

**Table 2. Absolute maximum ratings**

Symbol	Parameter	Value		Unit
		DPAK	TO-220FP	
V <sub>CES</sub>	Collector-emitter voltage (V <sub>GE</sub> = 0)	600		V
I <sub>C</sub> <sup>(1)</sup>	Continuous collector current at T <sub>C</sub> = 25 °C	18	10	A
I <sub>C</sub> <sup>(1)</sup>	Continuous collector current at T <sub>C</sub> = 100 °C	10	5	A
I <sub>CL</sub> <sup>(2)</sup>	Turn-off latching current	14		A
I <sub>CP</sub> <sup>(3)</sup>	Pulsed collector current	25		A
I <sub>F</sub>	Diode RMS forward current at T <sub>C</sub> =25 °C	10		A
I <sub>FSM</sub>	Surge non repetitive forward current t <sub>p</sub> = 10 ms sinusoidal	20		A
V <sub>GE</sub>	Gate-emitter voltage	±20		V
P <sub>TOT</sub>	Total dissipation at T <sub>C</sub> = 25 °C	60	25	W
V <sub>ISO</sub>	Isolation withstand voltage (RMS) from all three leads to external heat sink (t = 1 sec; T <sub>C</sub> = 25 °C)	2500		V
T <sub>j</sub>	Operating junction temperature	-55 to 150		°C

1. Calculated according to the iterative formula:

$$I_C(T_C) = \frac{T_{j(max)} - T_C}{R_{thj-c} \times V_{CE(sat)(max)}(T_{j(max)}, I_C(T_C))}$$

2. V<sub>clamp</sub> = 80%,(V<sub>CES</sub>), T<sub>j</sub> =150 °C, R<sub>G</sub> = 10 Ω, V<sub>GE</sub> = 15 V.

3. Pulse width limited by maximum junction temperature and turn-off within RBSOA.

**Table 3. Thermal data**

Symbol	Parameter	Value		Unit
		DPAK	TO-220FP	
R <sub>thj-case</sub>	Thermal resistance junction-case IGBT	2.08	5	°C/W
	Thermal resistance junction-case diode	4.5		°C/W
R <sub>thj-amb</sub>	Thermal resistance junction-ambient	100	62.5	°C/W

## 2 Electrical characteristics

( $T_J=25^\circ\text{C}$  unless otherwise specified)

**Table 4. Static**

Symbol	Parameter	Test conditions	Min.	Typ.	Max.	Unit
$V_{(BR)CES}$	Collector-emitter breakdown voltage ( $V_{GE}=0$ )	$I_C=1\text{ mA}$	600			V
$V_{CE(sat)}$	Collector-emitter saturation voltage	$V_{GE}=15\text{ V}$ , $I_C=5\text{ A}$ $V_{GE}=15\text{ V}$ , $I_C=5\text{ A}$ , $T_J=125^\circ\text{C}$		1.45 1.45	1.65	V V
$V_{GE(th)}$	Gate threshold voltage	$V_{CE}=V_{GE}$ , $I_C=250\text{ }\mu\text{A}$	3.75		5.75	V
$I_{CES}$	Collector cut-off current ( $V_{GE}=0$ )	$V_{CE}=600\text{ V}$ $V_{CE}=600\text{ V}$ , $T_J=125^\circ\text{C}$			150 1	$\mu\text{A}$ mA
$I_{GES}$	Gate-emitter leakage ( $V_{CE}=0$ )	$V_{GE}=\pm 20\text{ V}$			$\pm 100$	nA
$g_{fs}$	Forward transconductance	$V_{CE}=15\text{ V}$ , $I_C=5\text{ A}$		3.5		S

**Table 5. Dynamic**

Symbol	Parameter	Test conditions	Min.	Typ.	Max.	Unit
$C_{ies}$	Input capacitance	$V_{CE}=25\text{ V}$ , $f=1\text{ MHz}$ , $V_{GE}=0$	-	365	-	pF
$C_{oes}$	Output capacitance			44		
$C_{res}$	Reverse transfer capacitance			8		
$Q_g$	Total gate charge	$V_{CE}=480\text{ V}$ , $I_C=5\text{ A}$ ,	-	18	-	nC
$Q_{ge}$	Gate-emitter charge	$V_{GE}=15\text{ V}$		8		
$Q_{gc}$	Gate-collector charge	<a href="#">Figure 18</a>		3.5		

**Table 6. Switching on/off (inductive load)**

Symbol	Parameter	Test conditions	Min.	Typ.	Max.	Unit
$t_{d(on)}$ $t_r$ $(di/dt)_{on}$	Turn-on delay time Current rise time Turn-on current slope	$V_{CC} = 390\text{ V}$ , $I_C = 5\text{ A}$ $R_G = 10\ \Omega$ , $V_{GE} = 15\text{ V}$ , <i>Figure 19</i>	-	19 4 1330	-	ns ns A/ $\mu$ s
$t_{d(on)}$ $t_r$ $(di/dt)_{on}$	Turn-on delay time Current rise time Turn-on current slope	$V_{CC} = 390\text{ V}$ , $I_C = 5\text{ A}$ $R_G = 10\ \Omega$ , $V_{GE} = 15\text{ V}$ , $T_J = 125^\circ\text{C}$ <i>Figure 19</i>	-	18 4.5 1000	-	ns ns A/ $\mu$ s
$t_r(V_{off})$ $t_{d(off)}$ $t_f$	Off voltage rise time Turn-off delay time Current fall time	$V_{CC} = 390\text{ V}$ , $I_C = 5\text{ A}$ , $R_G = 10\ \Omega$ , $V_{GE} = 15\text{ V}$ , <i>Figure 19</i>	-	100 160 205	-	ns ns ns
$t_r(V_{off})$ $t_{d(off)}$ $t_f$	Off voltage rise time Turn-off delay time Current fall time	$V_{CC} = 390\text{ V}$ , $I_C = 5\text{ A}$ , $R_G = 10\ \Omega$ , $V_{GE} = 15\text{ V}$ , $T_J = 125^\circ\text{C}$ <i>Figure 19</i>	-	165 250 310	-	ns ns ns

**Table 7. Switching energy (inductive load)**

Symbol	Parameter	Test conditions	Min.	Typ.	Max.	Unit
$E_{on}^{(1)}$ $E_{off}^{(2)}$ $E_{ts}$	Turn-on switching losses Turn-off switching losses Total switching losses	$V_{CC} = 480\text{ V}$ , $I_C = 5\text{ A}$ $R_G = 10\ \Omega$ , $V_{GE} = 15\text{ V}$ , <i>Figure 17</i>	-	60 340 400	-	$\mu$ J $\mu$ J $\mu$ J
$E_{on}^{(1)}$ $E_{off}^{(2)}$ $E_{ts}$	Turn-on switching losses Turn-off switching losses Total switching losses	$V_{CC} = 480\text{ V}$ , $I_C = 5\text{ A}$ $R_G = 10\ \Omega$ , $V_{GE} = 15\text{ V}$ , $T_J = 125^\circ\text{C}$ <i>Figure 17</i>	-	90 540 630	-	$\mu$ J $\mu$ J $\mu$ J

1.  $E_{on}$  is the turn-on losses when a typical diode is used in the test circuit in *Figure 17*. If the IGBT is offered in a package with a co-pack diode, the co-pack diode is used as external diode. IGBTs and diode are at the same temperature.
2. Turn-off losses included also include also the tail of the collector current.

**Table 8. Collector-emitter diode**

Symbol	Parameter	Test conditions	Min.	Typ.	Max.	Unit
$V_F$	Forward on-voltage	$I_F = 5\text{ A}$ $I_F = 5\text{ A}$ , $T_J = 125^\circ\text{C}$	-	2 1.65	2.45	V V
$t_{rr}$ $Q_{rr}$ $I_{rrm}$	Reverse recovery time Reverse recovery charge Reverse recovery current	$I_F = 5\text{ A}$ , $V_R = 40\text{ V}$ , $di/dt = 100\text{ A}/\mu\text{s}$ <i>Figure 20</i>	-	22 14 1.3		ns nC A
$t_{rr}$ $Q_{rr}$ $I_{rrm}$	Reverse recovery time Reverse recovery charge Reverse recovery current	$I_F = 5\text{ A}$ , $V_R = 40\text{ V}$ , $T_J = 125^\circ\text{C}$ , $di/dt = 100\text{ A}/\mu\text{s}$ <i>Figure 20</i>	-	34 35 2.1		ns nC A

## 2.1 Electrical characteristics (curves)

Figure 2. Output characteristics

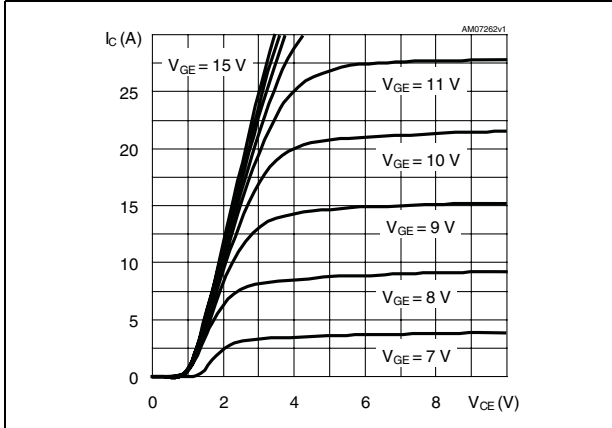

Figure 3. Transfer characteristics

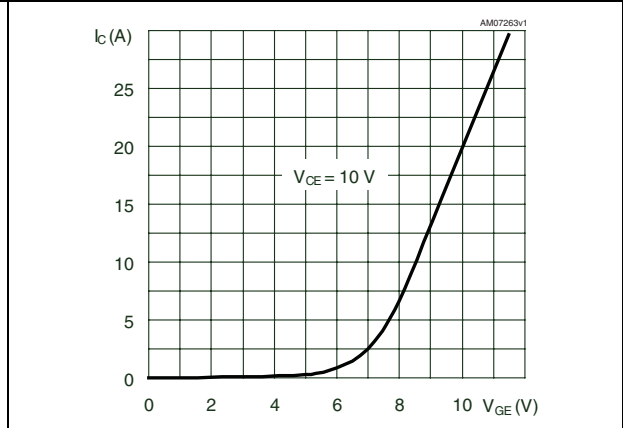

Figure 4. Collector-emitter on voltage vs collector current

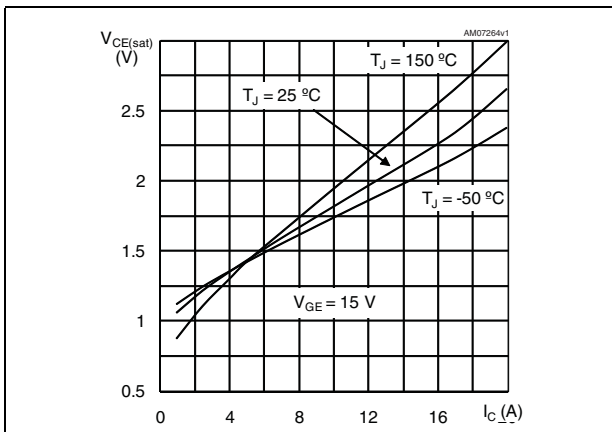

Figure 5. Collector-emitter on voltage vs temperature

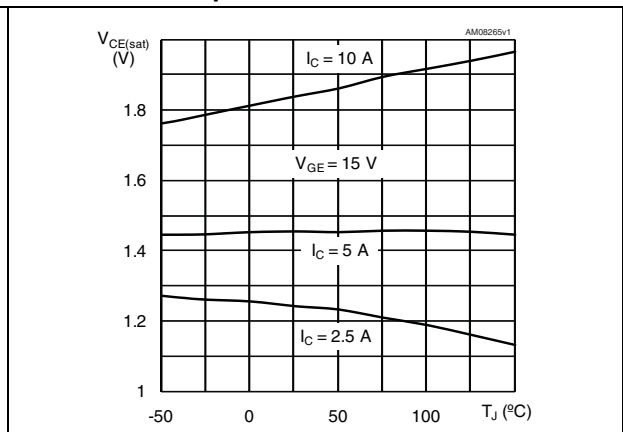

Figure 6. Normalized breakdown voltage vs temperature

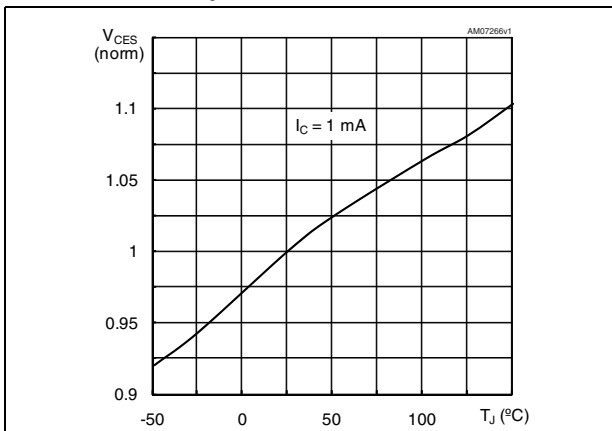

Figure 7. Normalized gate threshold vs temperature

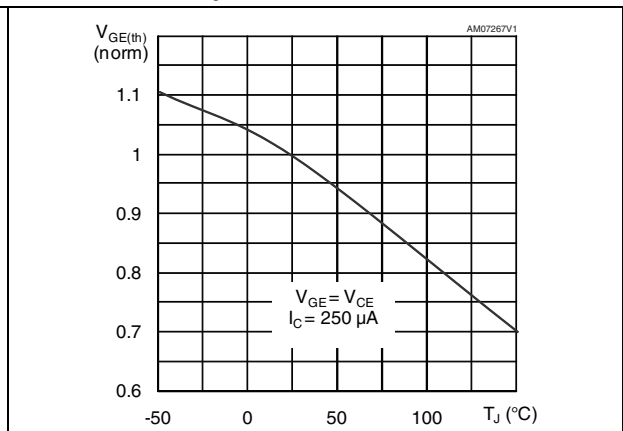

Figure 8. Capacitance variations

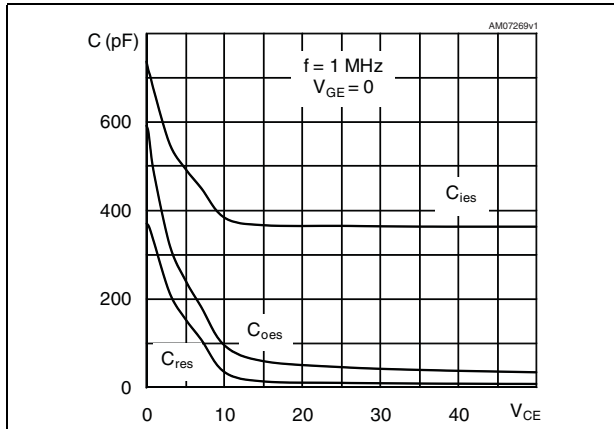

Figure 9. Gate charge vs gate-emitter voltage

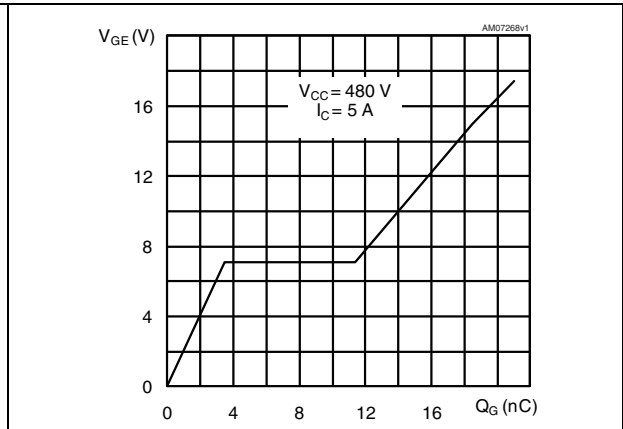

Figure 10. Switching losses vs temperature

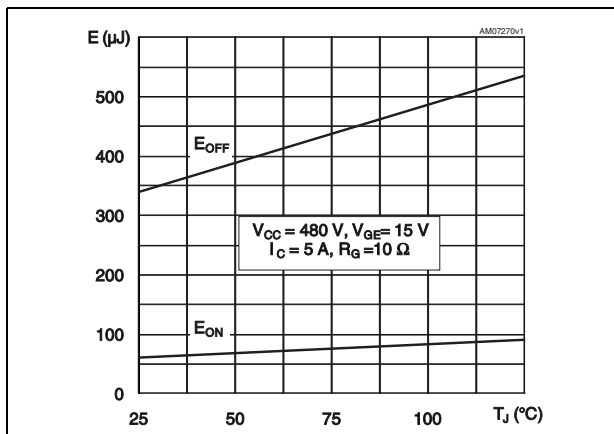

Figure 11. Switching losses vs gate resistance

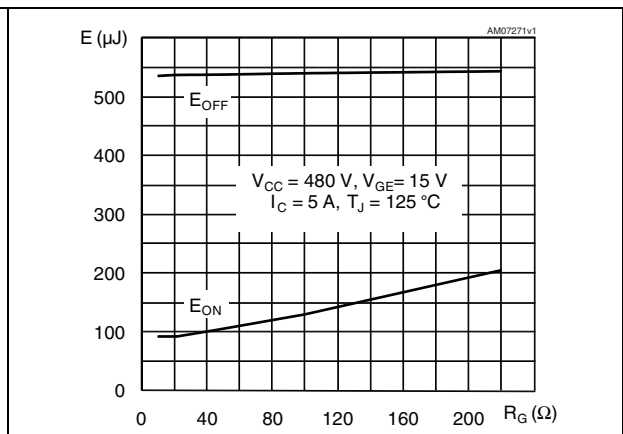

Figure 12. Switching losses vs collector current

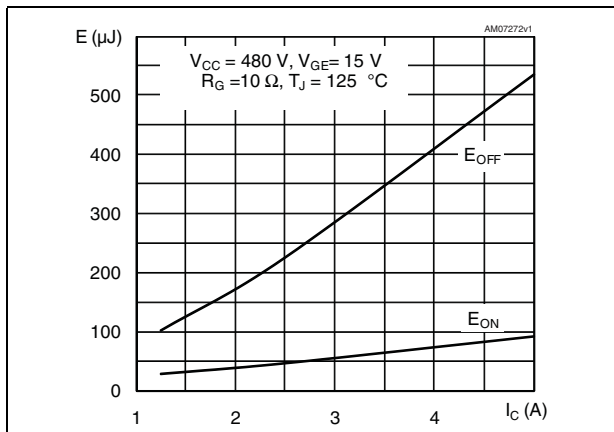

Figure 13. Diode forward on voltage

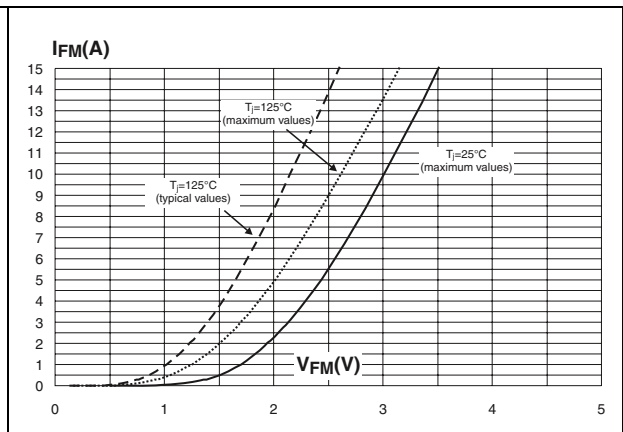

Figure 14. Thermal impedance for DPAK

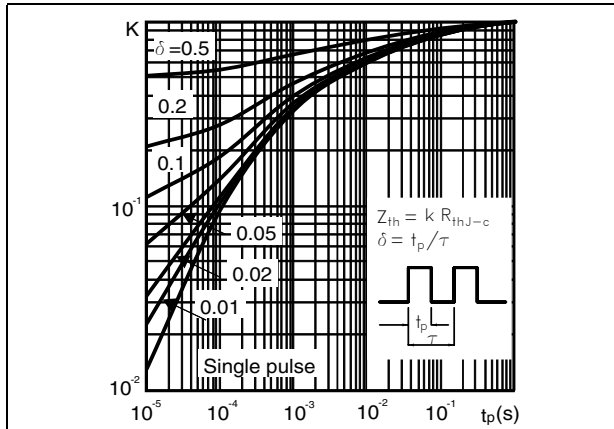

Figure 15. Thermal impedance for TO-220FP

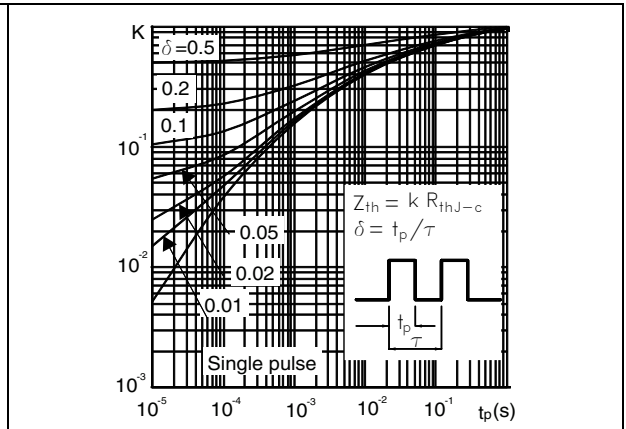
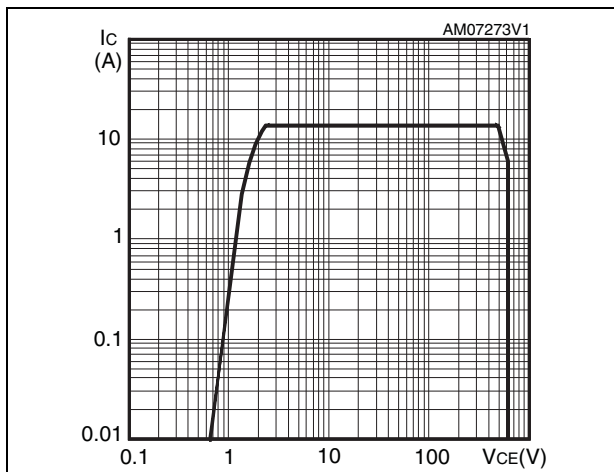

Figure 16. Turn-off SOA





### 3 Test circuits

Figure 17. Test circuit for inductive load switching

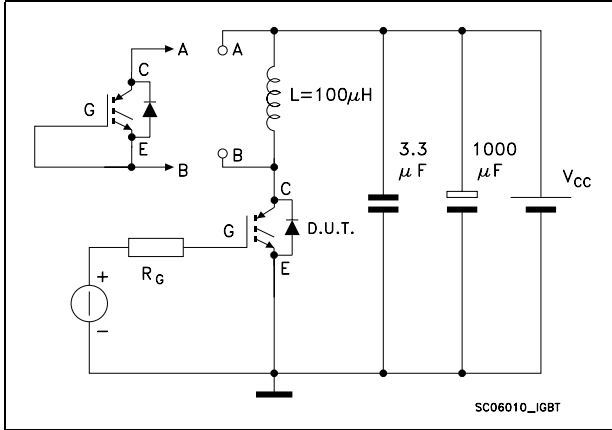

Figure 18. Gate charge test circuit

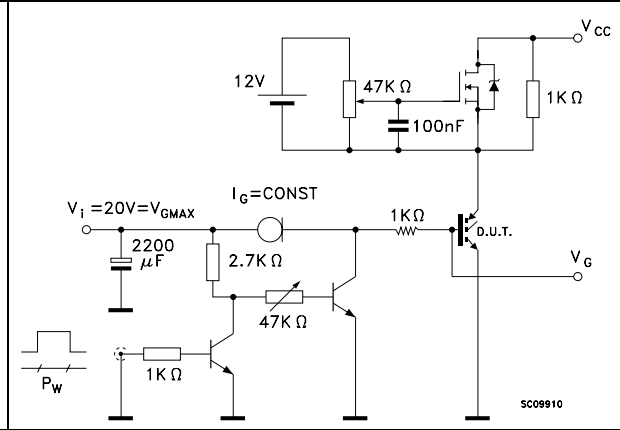

Figure 19. Switching waveforms

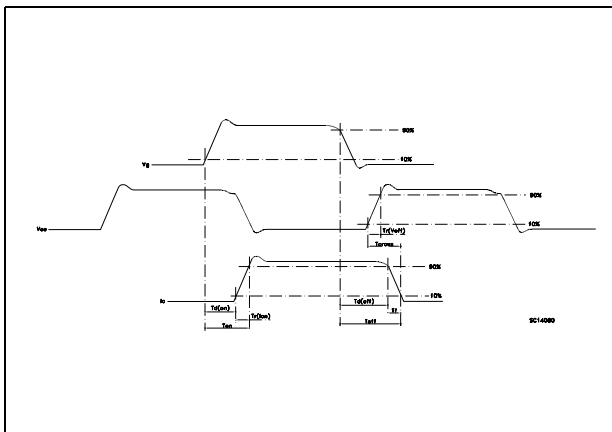
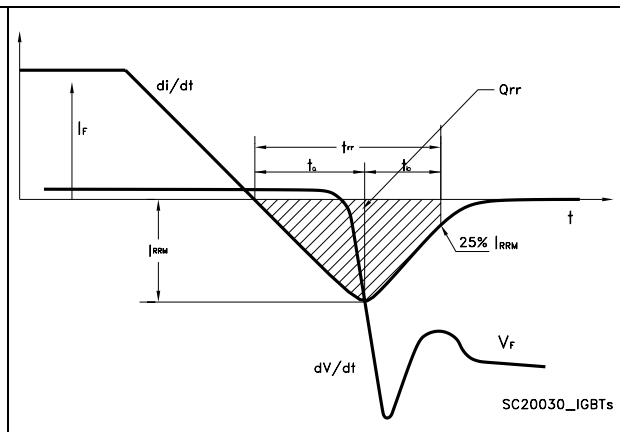

Figure 20. Diode recovery time waveform



## 4 Package mechanical data

In order to meet environmental requirements, ST offers these devices in different grades of ECOPACK<sup>®</sup> packages, depending on their level of environmental compliance. ECOPACK<sup>®</sup> specifications, grade definitions and product status are available at: [www.st.com](http://www.st.com). ECOPACK is an ST trademark.

**TO-252 (DPAK) mechanical data**

DIM.	mm.		
	min.	typ	max.
A	2.20		2.40
A1	0.90		1.10
A2	0.03		0.23
b	0.64		0.90
b4	5.20		5.40
c	0.45		0.60
c2	0.48		0.60
D	6.00		6.20
D1		5.10	
E	6.40		6.60
E1		4.70	
e		2.28	
e1	4.40		4.60
H	9.35		10.10
L	1		
L1		2.80	
L2		0.80	
L4	0.60		1
R		0.20	
V2	0°		8°

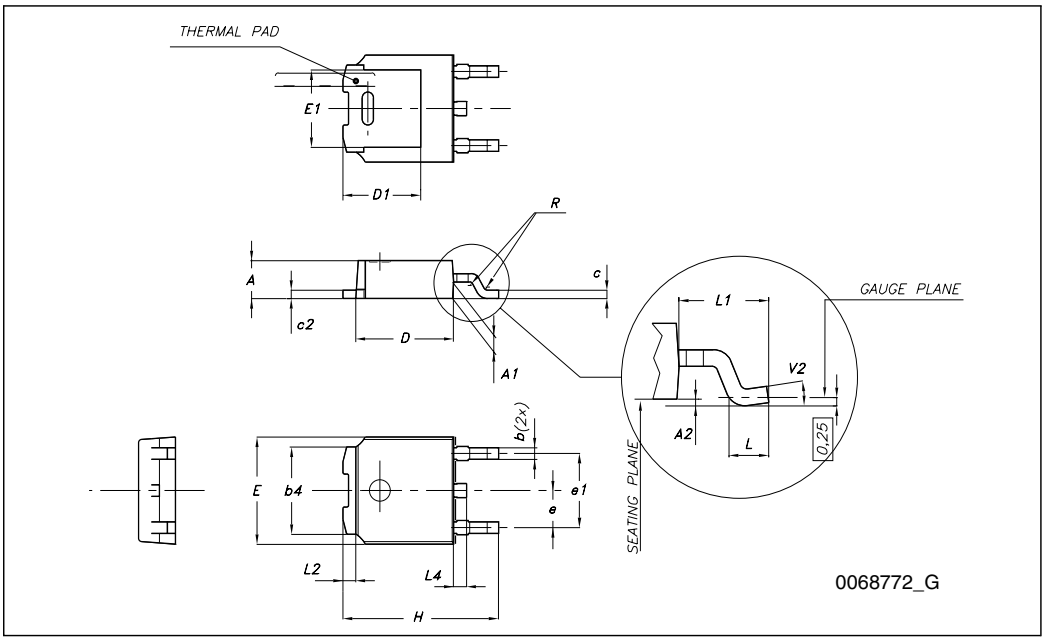
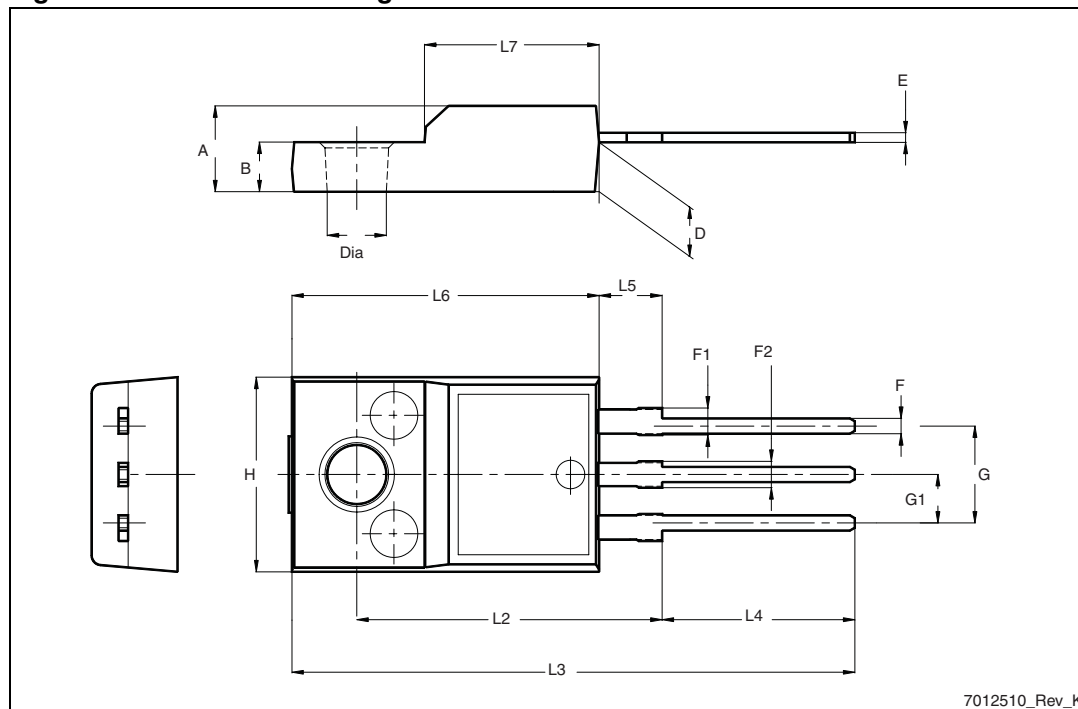

Table 9. TO-220FP mechanical data

Dim.	mm		
	Min.	Typ.	Max.
A	4.4		4.6
B	2.5		2.7
D	2.5		2.75
E	0.45		0.7
F	0.75		1
F1	1.15		1.70
F2	1.15		1.70
G	4.95		5.2
G1	2.4		2.7
H	10		10.4
L2		16	
L3	28.6		30.6
L4	9.8		10.6
L5	2.9		3.6
L6	15.9		16.4
L7	9		9.3
Dia	3		3.2

Figure 21. TO-220FP drawing



# 5 Packaging mechanical data

## DPAK FOOTPRINT

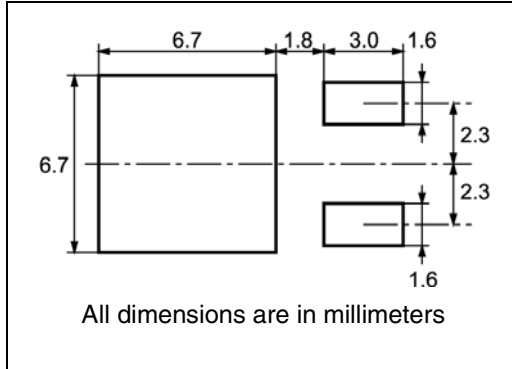

## TAPE AND REEL SHIPMENT

REEL MECHANICAL DATA				
DIM.	mm		inch	
	MIN.	MAX.	MIN.	MAX.
A		330		12.992
B	1.5		0.059	
C	12.8	13.2	0.504	0.520
D	20.2		0.795	
G	16.4	18.4	0.645	0.724
N	50		1.968	
T		22.4		0.881

**TAPE MECHANICAL DATA**

DIM.	mm		inch	
	MIN.	MAX.	MIN.	MAX.
A0	6.8	7	0.267	0.275
B0	10.4	10.6	0.409	0.417
B1		12.1		0.476
D	1.5	1.6	0.059	0.063
D1	1.5		0.059	
E	1.65	1.85	0.065	0.073
F	7.4	7.6	0.291	0.299
K0	2.55	2.75	0.100	0.108
P0	3.9	4.1	0.153	0.161
P1	7.9	8.1	0.311	0.319
P2	1.9	2.1	0.075	0.082
R	40		1.574	
W	15.7	16.3	0.618	0.641

BASE QTY	BULK QTY
2500	2500

## 6 Revision history

Table 10. Document revision history

Date	Revision	Changes
06-Jul-2009	1	Initial release
14-Jun-2010	2	Inserted <a href="#">Section 2.1: Electrical characteristics (curves)</a> .

**Please Read Carefully:**

Information in this document is provided solely in connection with ST products. STMicroelectronics NV and its subsidiaries ("ST") reserve the right to make changes, corrections, modifications or improvements, to this document, and the products and services described herein at any time, without notice.

All ST products are sold pursuant to ST's terms and conditions of sale.

Purchasers are solely responsible for the choice, selection and use of the ST products and services described herein, and ST assumes no liability whatsoever relating to the choice, selection or use of the ST products and services described herein.

No license, express or implied, by estoppel or otherwise, to any intellectual property rights is granted under this document. If any part of this document refers to any third party products or services it shall not be deemed a license grant by ST for the use of such third party products or services, or any intellectual property contained therein or considered as a warranty covering the use in any manner whatsoever of such third party products or services or any intellectual property contained therein.

**UNLESS OTHERWISE SET FORTH IN ST'S TERMS AND CONDITIONS OF SALE ST DISCLAIMS ANY EXPRESS OR IMPLIED WARRANTY WITH RESPECT TO THE USE AND/OR SALE OF ST PRODUCTS INCLUDING WITHOUT LIMITATION IMPLIED WARRANTIES OF MERCHANTABILITY, FITNESS FOR A PARTICULAR PURPOSE (AND THEIR EQUIVALENTS UNDER THE LAWS OF ANY JURISDICTION), OR INFRINGEMENT OF ANY PATENT, COPYRIGHT OR OTHER INTELLECTUAL PROPERTY RIGHT.**

**UNLESS EXPRESSLY APPROVED IN WRITING BY AN AUTHORIZED ST REPRESENTATIVE, ST PRODUCTS ARE NOT RECOMMENDED, AUTHORIZED OR WARRANTED FOR USE IN MILITARY, AIR CRAFT, SPACE, LIFE SAVING, OR LIFE SUSTAINING APPLICATIONS, NOR IN PRODUCTS OR SYSTEMS WHERE FAILURE OR MALFUNCTION MAY RESULT IN PERSONAL INJURY, DEATH, OR SEVERE PROPERTY OR ENVIRONMENTAL DAMAGE. ST PRODUCTS WHICH ARE NOT SPECIFIED AS "AUTOMOTIVE GRADE" MAY ONLY BE USED IN AUTOMOTIVE APPLICATIONS AT USER'S OWN RISK.**

Resale of ST products with provisions different from the statements and/or technical features set forth in this document shall immediately void any warranty granted by ST for the ST product or service described herein and shall not create or extend in any manner whatsoever, any liability of ST.

ST and the ST logo are trademarks or registered trademarks of ST in various countries.

Information in this document supersedes and replaces all information previously supplied.

The ST logo is a registered trademark of STMicroelectronics. All other names are the property of their respective owners.

© 2010 STMicroelectronics - All rights reserved

STMicroelectronics group of companies

Australia - Belgium - Brazil - Canada - China - Czech Republic - Finland - France - Germany - Hong Kong - India - Israel - Italy - Japan - Malaysia - Malta - Morocco - Philippines - Singapore - Spain - Sweden - Switzerland - United Kingdom - United States of America

[www.st.com](http://www.st.com)