

## Trench gate field-stop 650 V, 60 A high speed HB series IGBT

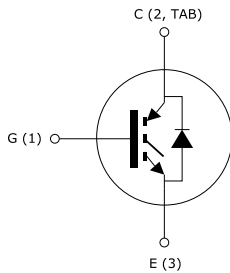
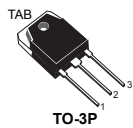
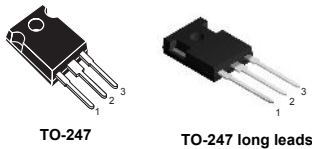

### Features

- Maximum junction temperature:  $T_J = 175\text{ }^\circ\text{C}$
- High speed switching series
- Minimized tail current
- Low saturation voltage:  $V_{CE(sat)} = 1.6\text{ V (typ.) @ } I_C = 60\text{ A}$
- Tight parameter distribution
- Safe paralleling
- Positive  $V_{CE(sat)}$  temperature coefficient
- Low thermal resistance
- Very fast soft recovery antiparallel diode

### Applications

- Photovoltaic inverters
- High-frequency converters

### Description

These devices are IGBTs developed using an advanced proprietary trench gate field-stop structure. These devices are part of the new HB series of IGBTs, which represent an optimum compromise between conduction and switching loss to maximize the efficiency of any frequency converter. Furthermore, the slightly positive  $V_{CE(sat)}$  temperature coefficient and very tight parameter distribution result in safer paralleling operation.

#### Product status link

[STGW60H65DFB](#)
[STGWT60H65DFB](#)
[STGWA60H65DFB](#)

# 1 Electrical ratings

**Table 1. Absolute maximum ratings**

Symbol	Parameter	Value	Unit
$V_{CES}$	Collector-emitter voltage ( $V_{GE} = 0$ V)	650	V
$I_C$	Continuous collector current at $T_C = 25$ °C	80 <sup>(1)</sup>	A
	Continuous collector current at $T_C = 100$ °C	60	A
$I_{CP}$ <sup>(2)(3)</sup>	Pulsed collector current	240	A
$V_{GE}$	Gate-emitter voltage	±20	V
	Transient gate-emitter voltage ( $t_p \leq 10$ μs)	±30	V
$I_F$	Continuous forward current at $T_C = 25$ °C	80 <sup>(1)</sup>	A
	Continuous forward current at $T_C = 100$ °C	60	A
$I_{FP}$ <sup>(2)(3)</sup>	Pulsed forward current	240	A
$P_{TOT}$	Total power dissipation at $T_C = 25$ °C	375	W
$T_{STG}$	Storage temperature range	-55 to 150	°C
$T_J$	Operating junction temperature range	-55 to 175	°C

1. Current level is limited by bond wires.
2. Pulse width is limited by maximum junction temperature.
3. Defined by design, not subject to production test.

**Table 2. Thermal data**

Symbol	Parameter	Value	Unit
$R_{thJC}$	Thermal resistance junction-case IGBT	0.4	°C/W
$R_{thJC}$	Thermal resistance junction-case diode	1.14	°C/W
$R_{thJA}$	Thermal resistance junction-ambient	50	°C/W

## 2 Electrical characteristics

$T_J = 25\text{ °C}$  unless otherwise specified

**Table 3. Static characteristics**

Symbol	Parameter	Test conditions	Min.	Typ.	Max.	Unit
$V_{(BR)CES}$	Collector-emitter breakdown voltage	$V_{GE} = 0\text{ V}, I_C = 2\text{ mA}$	650			V
$V_{CE(sat)}$	Collector-emitter saturation voltage	$V_{GE} = 15\text{ V}, I_C = 60\text{ A}$		1.60	2	V
		$V_{GE} = 15\text{ V}, I_C = 60\text{ A}, T_J = 125\text{ °C}$		1.75		
		$V_{GE} = 15\text{ V}, I_C = 60\text{ A}, T_J = 175\text{ °C}$		1.85		
$V_F$	Forward on-voltage	$I_F = 60\text{ A}$		2	2.6	V
		$I_F = 60\text{ A}, T_J = 125\text{ °C}$		1.7		
		$I_F = 60\text{ A}, T_J = 175\text{ °C}$		1.6		
$V_{GE(th)}$	Gate threshold voltage	$V_{CE} = V_{GE}, I_C = 1\text{ mA}$	5	6	7	V
$I_{CES}$	Collector cut-off current	$V_{GE} = 0\text{ V}, V_{CE} = 650\text{ V}$			25	$\mu\text{A}$
$I_{GES}$	Gate-emitter leakage current	$V_{CE} = 0\text{ V}, V_{GE} = \pm 20\text{ V}$			$\pm 250$	nA

**Table 4. Dynamic characteristics**

Symbol	Parameter	Test conditions	Min.	Typ.	Max.	Unit
$C_{ies}$	Input capacitance	$V_{CE} = 25\text{ V}, f = 1\text{ MHz}, V_{GE} = 0\text{ V}$	-	7792	-	pF
$C_{oes}$	Output capacitance		-	262	-	pF
$C_{res}$	Reverse transfer capacitance		-	158	-	pF
$Q_g$	Total gate charge	$V_{CC} = 520\text{ V}, I_C = 60\text{ A},$	-	306	-	nC
$Q_{ge}$	Gate-emitter charge	$V_{GE} = 0\text{ to }15\text{ V}$ (see Figure 28. Gate charge test circuit)	-	126	-	nC
$Q_{gc}$	Gate-collector charge		-	58	-	nC

**Table 5. IGBT switching characteristics (inductive load)**

Symbol	Parameter	Test conditions	Min.	Typ.	Max.	Unit
$t_{d(on)}$	Turn-on delay time	$V_{CE} = 400\text{ V}$ , $I_C = 60\text{ A}$ , $R_G = 10\ \Omega$ , $V_{GE} = 15\text{ V}$ (see Figure 27. Test circuit for inductive load switching)	-	66	-	ns
$t_r$	Current rise time		-	38	-	ns
$(di/dt)_{on}$	Turn-on current slope		-	1216	-	A/ $\mu$ s
$t_{d(off)}$	Turn-off delay time		-	210	-	ns
$t_f$	Current fall time		-	20	-	ns
$E_{on}^{(1)}$	Turn-on switching energy		-	1590	-	$\mu$ J
$E_{off}^{(2)}$	Turn-off switching energy		-	900	-	$\mu$ J
$E_{ts}$	Total switching energy		-	2490	-	$\mu$ J
$t_{d(on)}$	Turn-on delay time		$V_{CE} = 400\text{ V}$ , $I_C = 60\text{ A}$ , $R_G = 10\ \Omega$ , $V_{GE} = 15\text{ V}$ , $T_J = 175\text{ }^\circ\text{C}$ (see Figure 27. Test circuit for inductive load switching)	-	59	-
$t_r$	Current rise time	-		40	-	ns
$(di/dt)_{on}$	Turn-on current slope	-		1230	-	A/ $\mu$ s
$t_{d(off)}$	Turn-off-delay time	-		242	-	ns
$t_f$	Current fall time	-		147	-	ns
$E_{on}^{(1)}$	Turn-on switching energy	-		2860	-	$\mu$ J
$E_{off}^{(2)}$	Turn-off switching energy	-		1255	-	$\mu$ J
$E_{ts}$	Total switching energy	-		4115	-	$\mu$ J

1. Including the reverse recovery of the diode.
2. Including the tail of the collector current.

**Table 6. Diode switching characteristics (inductive load)**

Symbol	Parameter	Test conditions	Min.	Typ.	Max.	Unit
$t_{rr}$	Reverse recovery time	$I_F = 60\text{ A}$ , $V_R = 400\text{ V}$ , $V_{GE} = 15\text{ V}$ , $di/dt = 100\text{ A}/\mu\text{s}$ (see Figure 27. Test circuit for inductive load switching)	-	60	-	ns
$Q_{rr}$	Reverse recovery charge		-	99	-	nC
$I_{rrm}$	Reverse recovery current		-	3.3	-	A
$dI_{rr}/dt$	Peak rate of fall of reverse recovery current during $t_b$		-	187	-	A/ $\mu$ s
$E_{rr}$	Reverse recovery energy		-	68	-	$\mu$ J
$t_{rr}$	Reverse recovery time	$I_F = 60\text{ A}$ , $V_R = 400\text{ V}$ , $V_{GE} = 15\text{ V}$ , $di/dt = 100\text{ A}/\mu\text{s}$ , $T_J = 175\text{ }^\circ\text{C}$ (see Figure 27. Test circuit for inductive load switching)	-	310	-	ns
$Q_{rr}$	Reverse recovery charge		-	1550	-	nC
$I_{rrm}$	Reverse recovery current		-	10	-	A
$dI_{rr}/dt$	Peak rate of fall of reverse recovery current during $t_b$		-	59	-	A/ $\mu$ s
$E_{rr}$	Reverse recovery energy		-	674	-	$\mu$ J

**2.1 Electrical characteristics (curves)**
**Figure 1. Output characteristics ( $T_J = 25^\circ\text{C}$ )**

**Figure 2. Output characteristics ( $T_J = 175^\circ\text{C}$ )**

**Figure 3. Transfer characteristics**

**Figure 4. Collector current vs case temperature**

**Figure 5. Power dissipation vs case temperature**

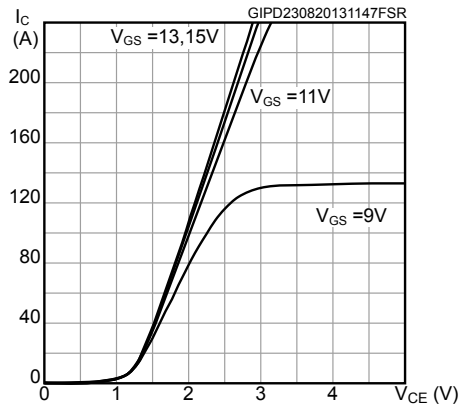
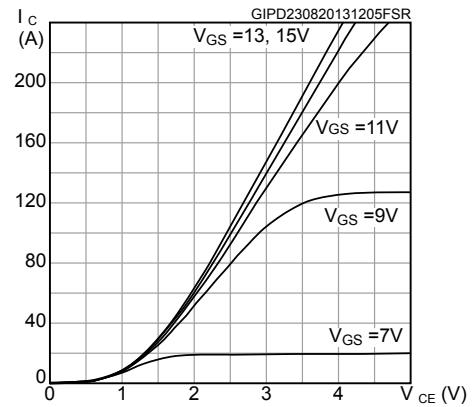
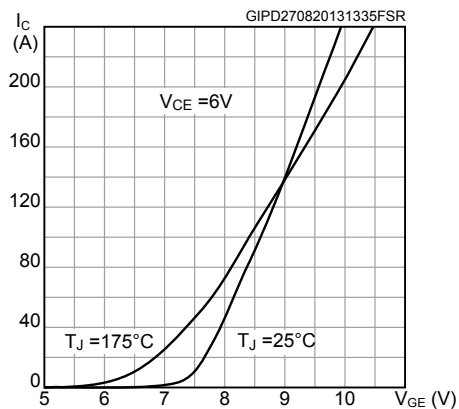
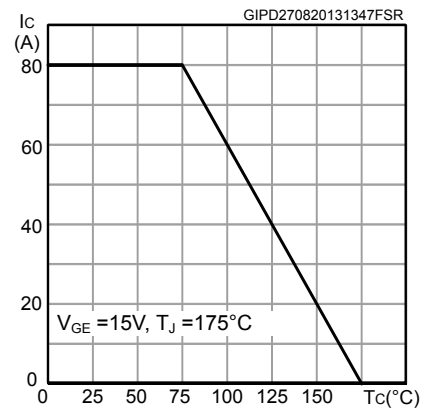
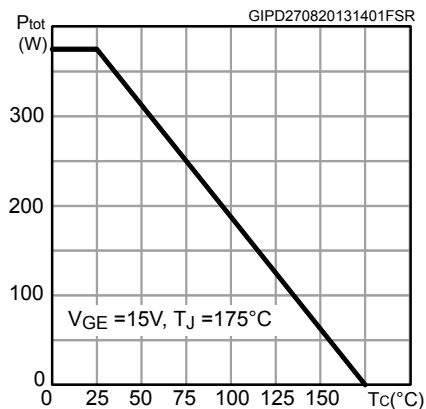
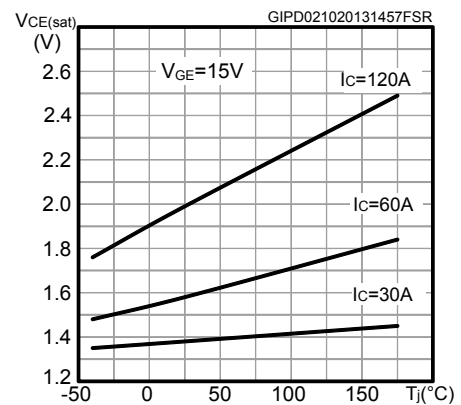
**Figure 6.  $V_{CE(sat)}$  vs junction temperature**

Figure 7.  $V_{CE(sat)}$  vs collector current

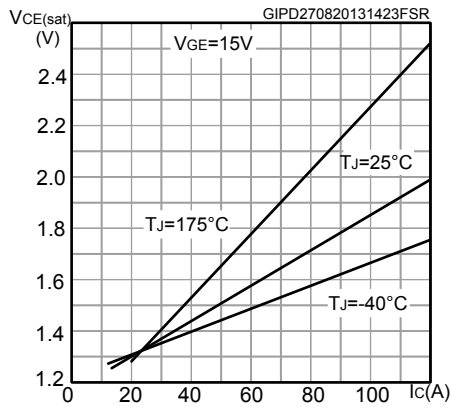

Figure 8. Forward bias safe operating area

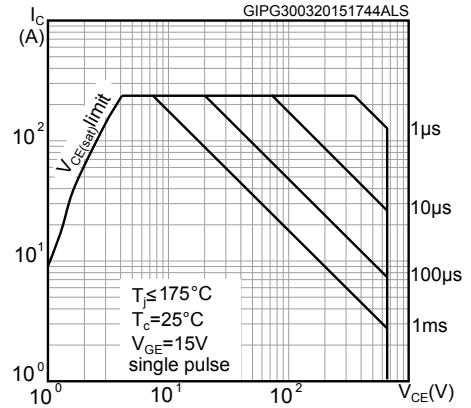

Figure 9. Diode  $V_F$  vs forward current

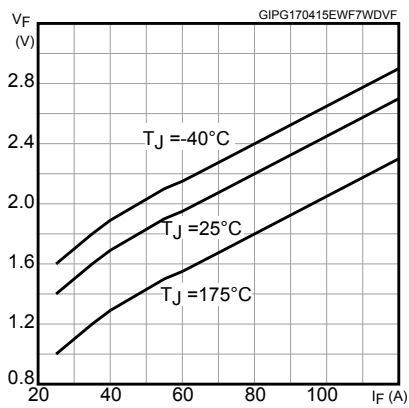

Figure 10. Normalized  $V_{(BR)CES}$  vs junction temperature

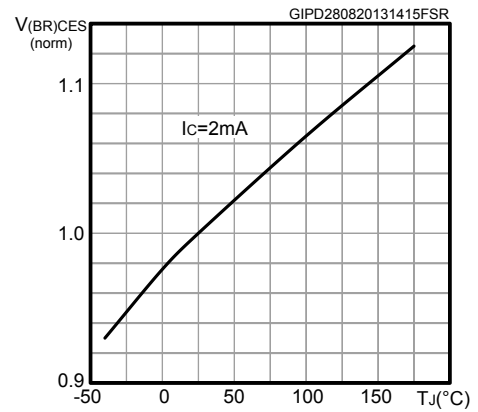

Figure 11. Normalized  $V_{GE(th)}$  vs junction temperature

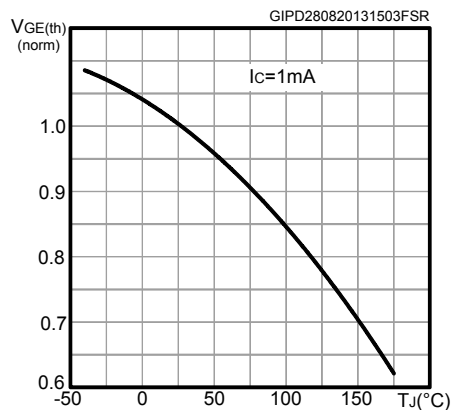
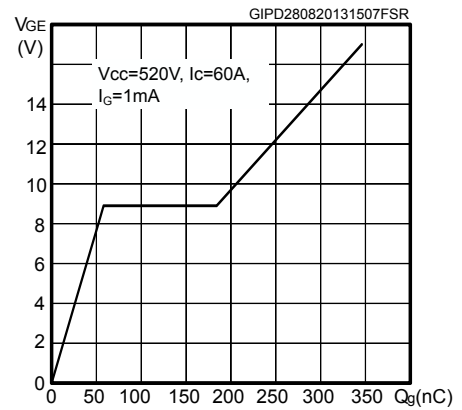
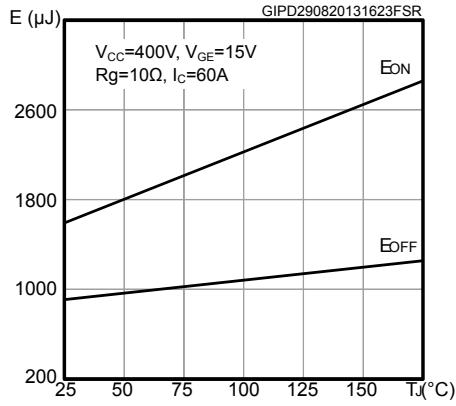
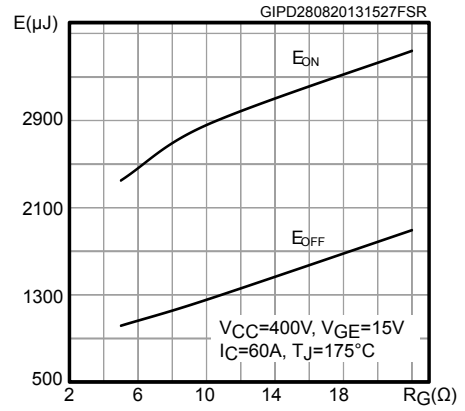
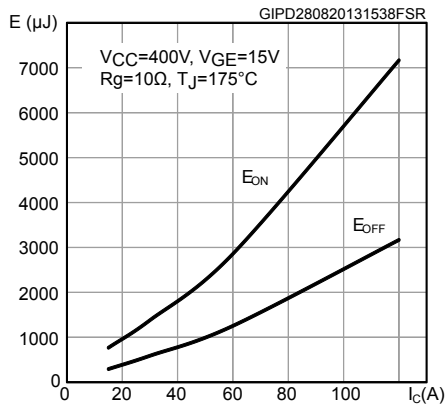
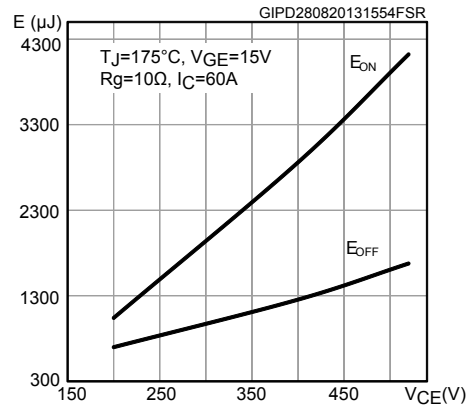
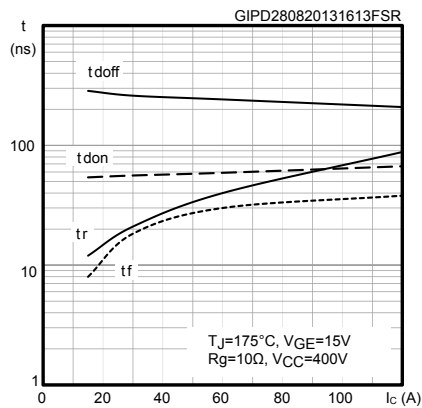
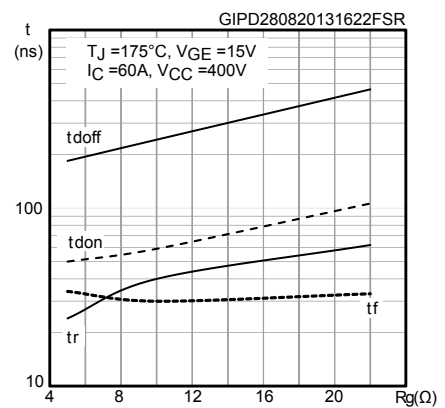

Figure 12. Gate charge vs gate-emitter voltage



**Figure 13. Switching energy vs temperature**

**Figure 14. Switching energy vs gate resistance**

**Figure 15. Switching energy vs collector current**

**Figure 16. Switching energy vs collector emitter voltage**

**Figure 17. Switching times vs collector current**

**Figure 18. Switching times vs gate resistance**

**Figure 19. Reverse recovery current vs diode current slope**

**Figure 20. Reverse recovery time vs diode current slope**

**Figure 21. Reverse recovery charge vs diode current slope**

**Figure 22. Reverse recovery energy vs diode current slope**

**Figure 23. Capacitance variations**

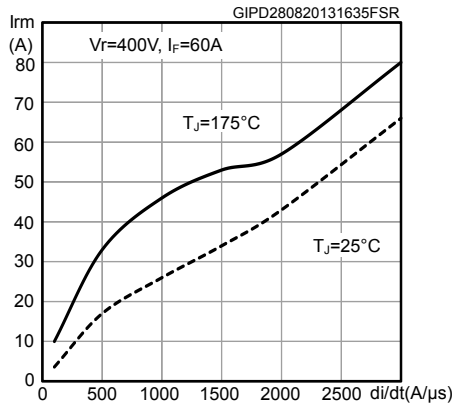
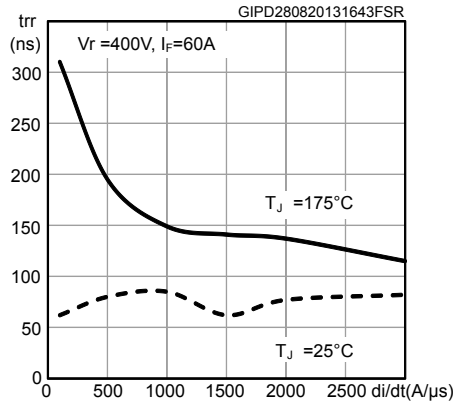
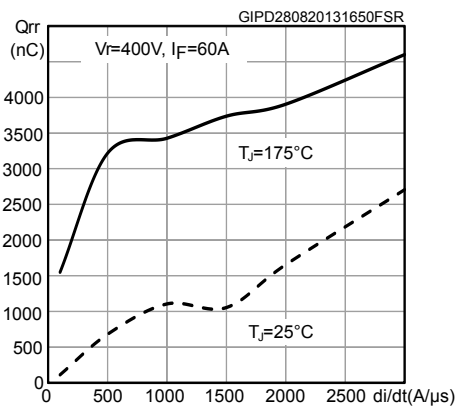
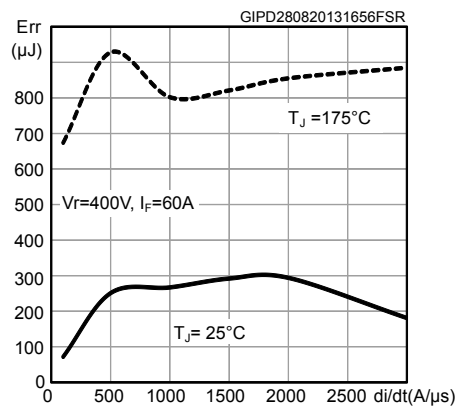
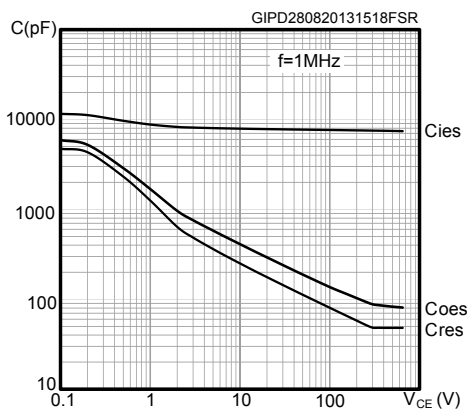
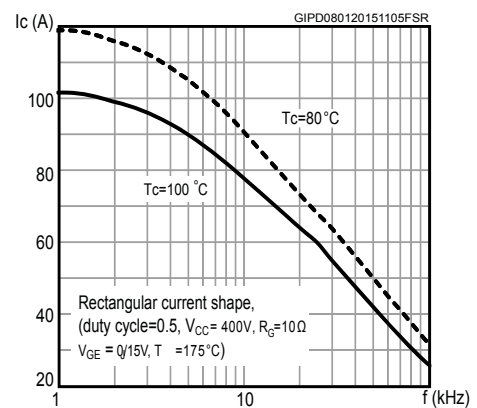
**Figure 24. Collector current vs switching frequency**



Figure 25. Thermal impedance for IGBT

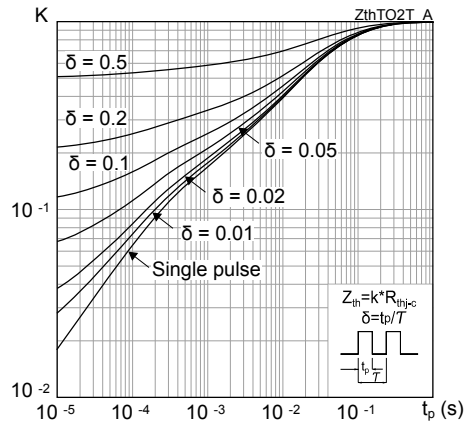
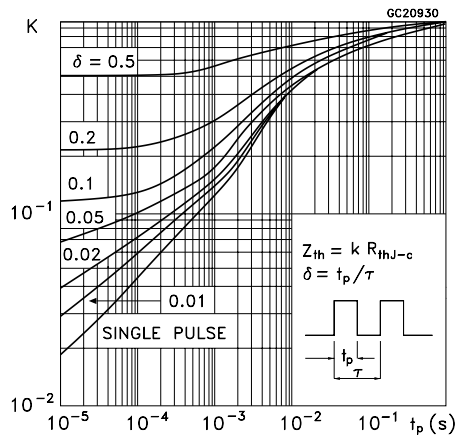

Figure 26. Thermal impedance for diode



### 3 Test circuits

Figure 27. Test circuit for inductive load switching

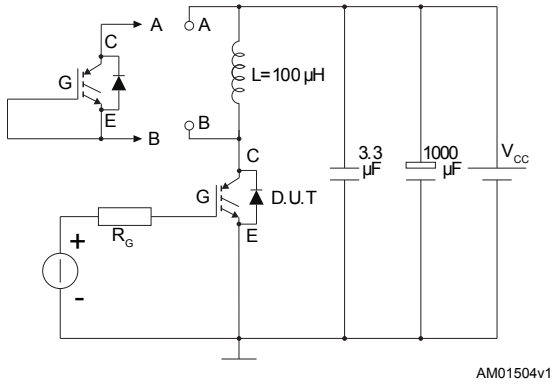

Figure 28. Gate charge test circuit

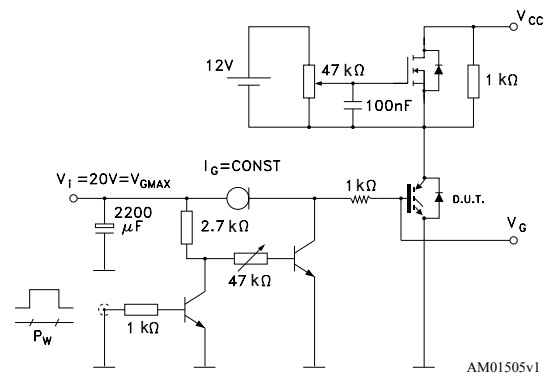

Figure 29. Switching waveform

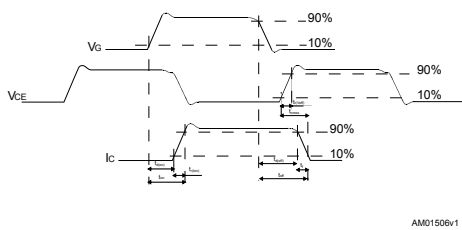
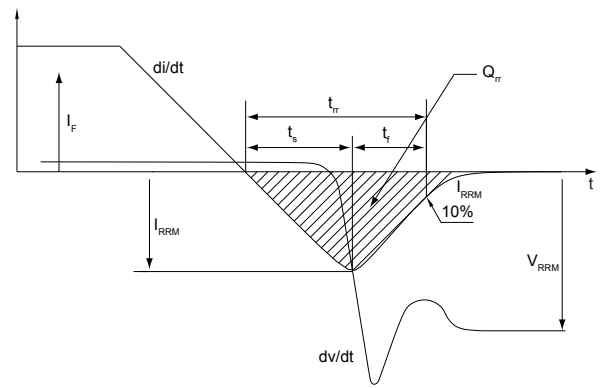

Figure 30. Diode reverse recovery waveform



## 4 Package information

---

In order to meet environmental requirements, ST offers these devices in different grades of **ECOPACK** packages, depending on their level of environmental compliance. ECOPACK specifications, grade definitions and product status are available at: [www.st.com](http://www.st.com). ECOPACK is an ST trademark.

### 4.1 TO-247 package information

Figure 31. TO-247 package outline

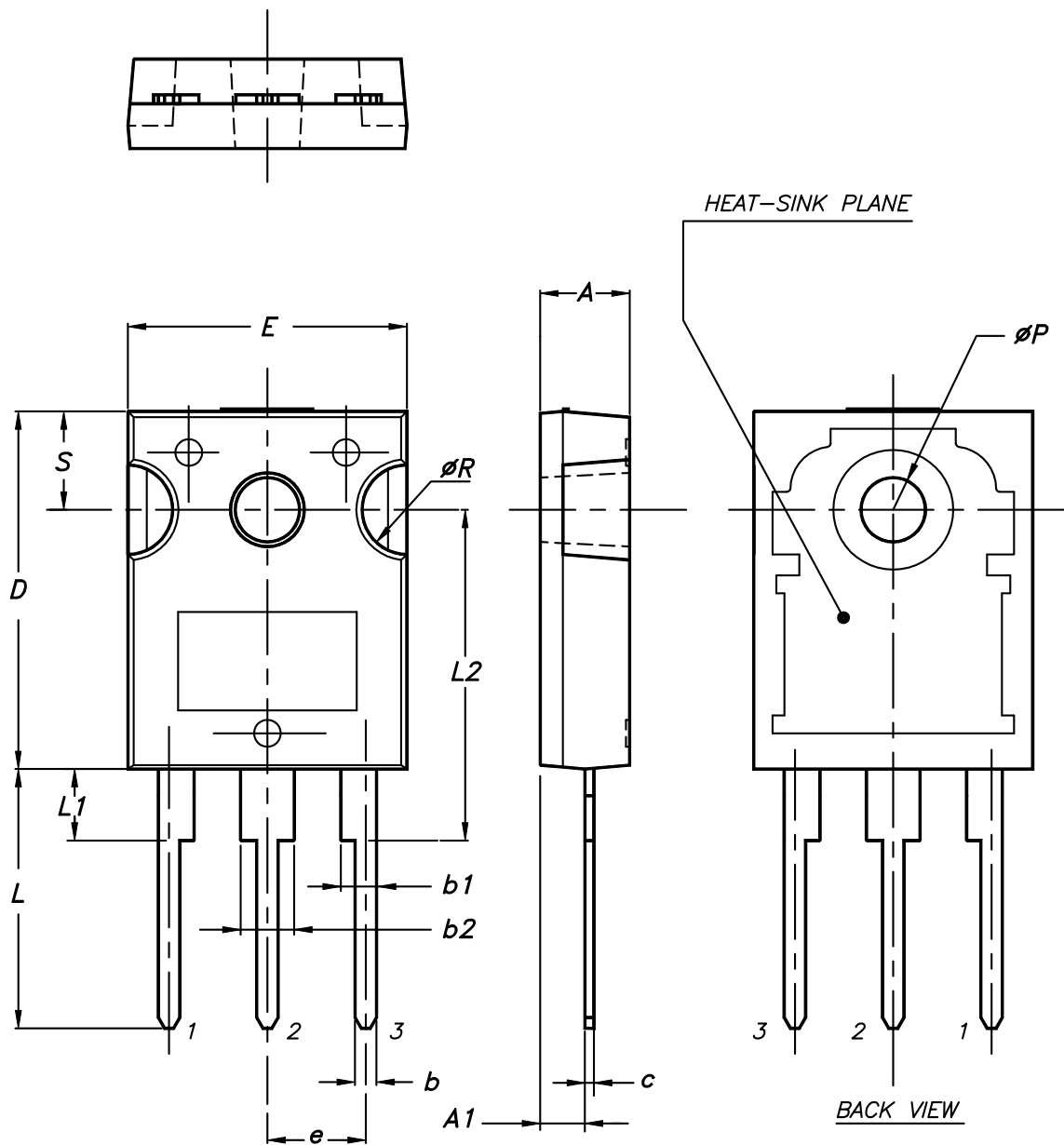

0075325\_9

**Table 7. TO-247 package mechanical data**

Dim.	mm		
	Min.	Typ.	Max.
A	4.85		5.15
A1	2.20		2.60
b	1.0		1.40
b1	2.0		2.40
b2	3.0		3.40
c	0.40		0.80
D	19.85		20.15
E	15.45		15.75
e	5.30	5.45	5.60
L	14.20		14.80
L1	3.70		4.30
L2		18.50	
ØP	3.55		3.65
ØR	4.50		5.50
S	5.30	5.50	5.70

## 4.2 TO-247 long leads package information

Figure 32. TO-247 long leads package outline

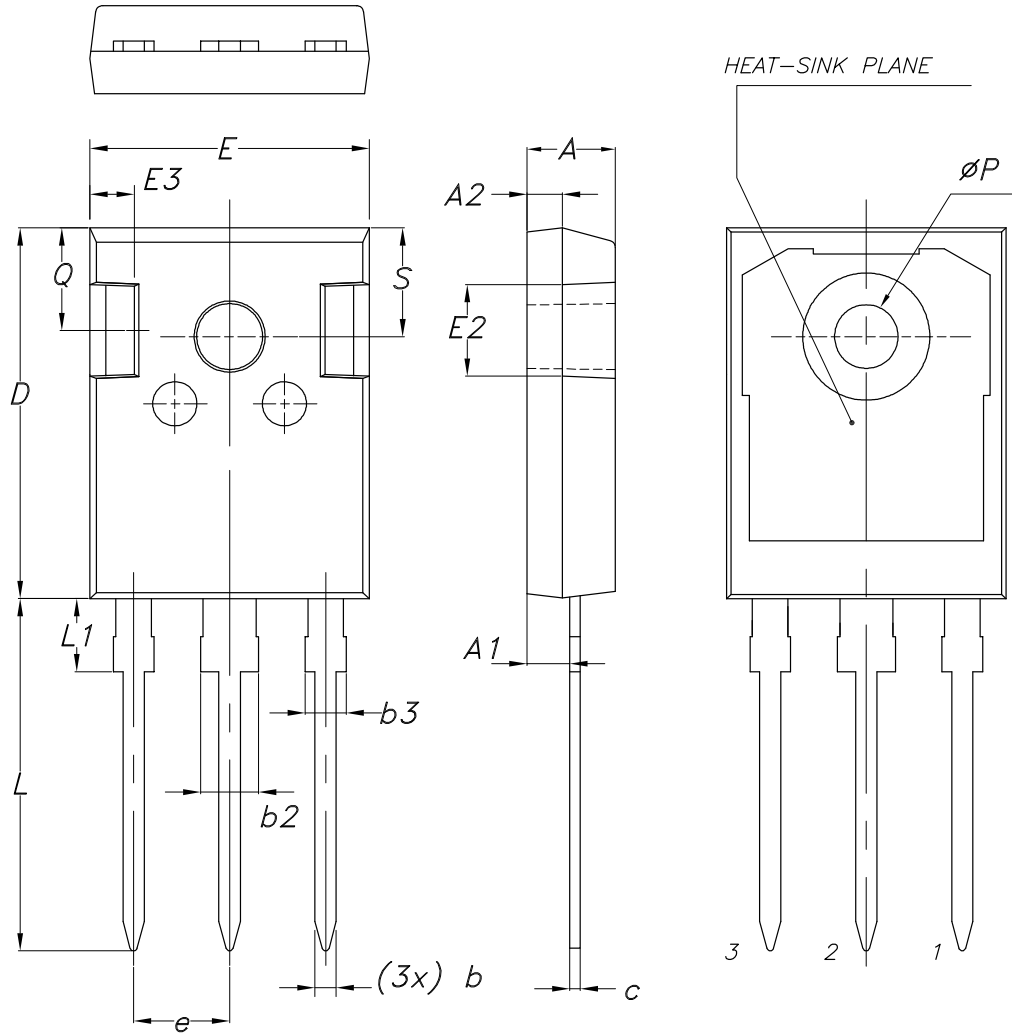

8463846\_2\_F

**Table 8. TO-247 long leads package mechanical data**

Dim.	mm		
	Min.	Typ.	Max.
A	4.90	5.00	5.10
A1	2.31	2.41	2.51
A2	1.90	2.00	2.10
b	1.16		1.26
b2			3.25
b3			2.25
c	0.59		0.66
D	20.90	21.00	21.10
E	15.70	15.80	15.90
E2	4.90	5.00	5.10
E3	2.40	2.50	2.60
e	5.34	5.44	5.54
L	19.80	19.92	20.10
L1			4.30
P	3.50	3.60	3.70
Q	5.60		6.00
S	6.05	6.15	6.25

### 4.3 TO-3P package information

Figure 33. TO-3P package outline

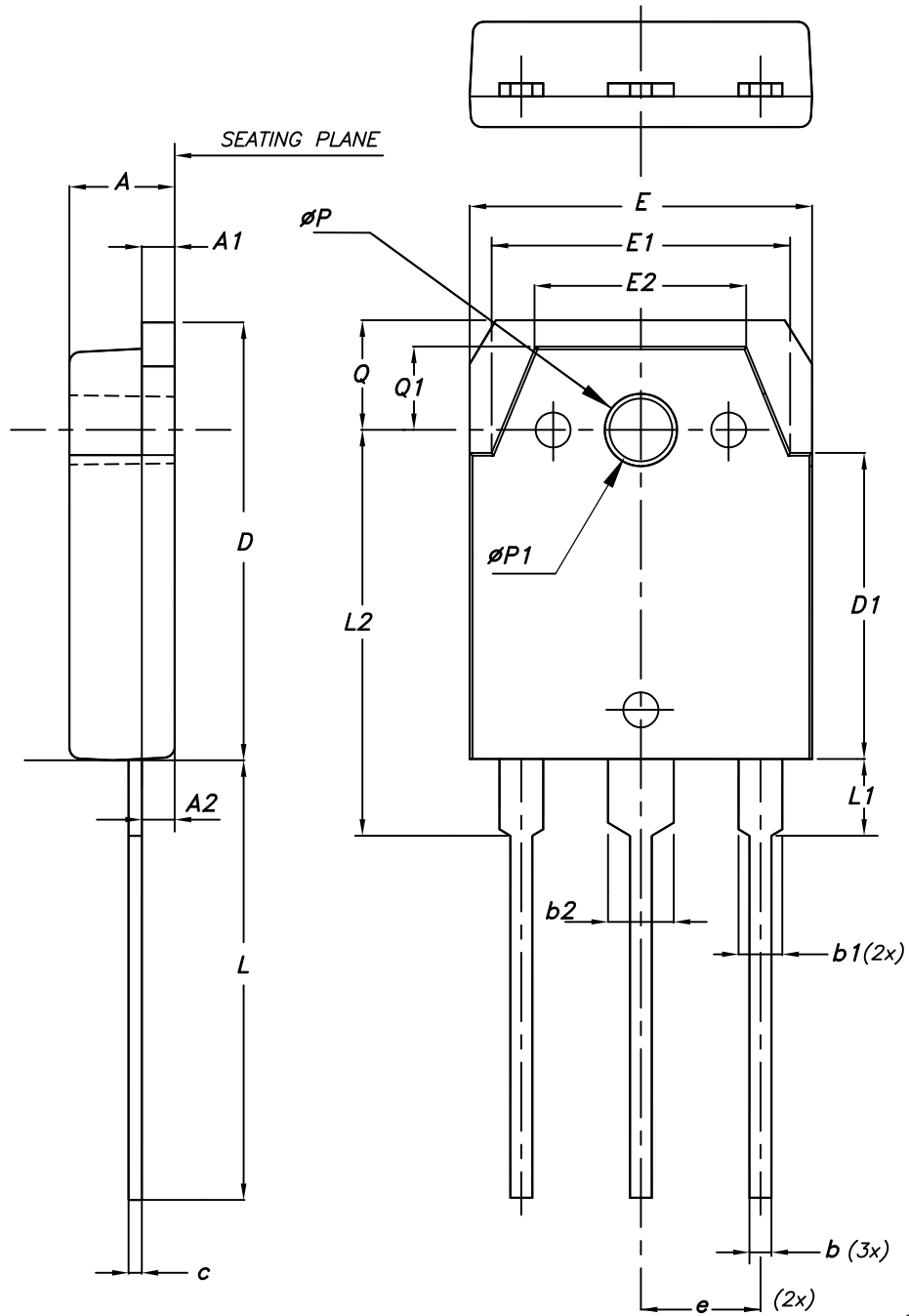

8045950\_3



**Table 9. TO-3P package mechanical data**

Dim.	mm		
	Min.	Typ.	Max.
A	4.60	4.80	5.00
A1	1.45	1.50	1.65
A2	1.20	1.40	1.60
b	0.80	1.00	1.20
b1	1.80	2.00	2.20
b2	2.80	3.00	3.20
c	0.55	0.60	0.75
D	19.70	19.90	20.10
D1	13.70	13.90	14.10
E	15.40	15.60	15.80
E1	13.40	13.60	13.80
E2	9.40	9.60	9.90
e	5.15	5.45	5.75
L	19.80	20.00	20.20
L1	3.30	3.50	3.70
L2	18.20	18.40	18.60
ØP	3.30	3.40	3.50
ØP1	3.10	3.20	3.30
Q	4.80	5.00	5.20
Q1	3.60	3.80	4.00

## 5 Ordering information

Table 10. Order codes

Order code	Marking	Package	Packing
STGW60H65DFB	GW60H65DFB	TO-247	Tube
STGWA60H65DFB	G60H65DFB	TO-247 long leads	Tube
STGWT60H65DFB	GWT60H65DFB	TO-3P	Tube

## Revision history

**Table 11. Document revision history**

Date	Revision	Changes
12-Mar-2013	1	Initial release.
30-Aug-2013	2	Document status promoted from preliminary to production data. Added <i>Section 2.1: Electrical characteristics (curves)</i> .
31-Oct-2013	3	Updated $V_{CE(sat)}$ in <i>Table 4: Static characteristics</i> .
24-Feb-2014	4	Updated title and description in cover page.
09-Jan-2015	5	Updated features in cover page, <i>Table 2: Absolute maximum ratings</i> , and <i>Table 6: IGBT switching characteristics (inductive load)</i> . Updated <i>Figure 5: Collector current vs. case temperature</i> , <i>Figure 6: Power dissipation vs. case temperature</i> , <i>Figure 8: VCE(sat) vs. collector current</i> , <i>Figure 18: Switching times vs collector current</i> , <i>Figure 19: Switching times vs gate resistance</i> and <i>Figure 20: Reverse recovery current vs. diode current slope</i> . Added <i>Figure 25: Collector current vs. switching frequency</i> . Updated <i>Section 4: Package information</i> . Minor text changes.
23-Mar-2015	6	Text edits throughout document. In document, added new order code STGWA60H65DFB in TO-247 long leads package, with accompanying information and data. In <i>Section 2.1: Electrical characteristics (curves)</i> : - updated <i>Figure 2, Figure 3, Figure 4, Figure 7, Figure 9</i>
17-Apr-2015	7	Text edits throughout document. In <i>Section 2: Electrical characteristics</i> : - updated <i>Table 4: Static characteristics</i> - updated <i>Table 6: IGBT switching characteristics (inductive load)</i> In <i>Section 2.1: Electrical characteristics (curves)</i> : - updated <i>Figure 3 and Figure 9</i>
22-Jul-2019	8	Updated <a href="#">Table 1. Absolute maximum ratings</a> . Minor text changes.

## Contents

<b>1</b>	<b>Electrical ratings</b> .....	<b>2</b>
<b>2</b>	<b>Electrical characteristics</b> .....	<b>3</b>
<b>2.1</b>	<b>Electrical characteristics (curves)</b> .....	<b>5</b>
<b>3</b>	<b>Test circuits</b> .....	<b>10</b>
<b>4</b>	<b>Package information</b> .....	<b>11</b>
<b>4.1</b>	<b>TO-247 package information</b> .....	<b>11</b>
<b>4.2</b>	<b>TO-247 long leads package information</b> .....	<b>13</b>
<b>4.3</b>	<b>TO-3P package information</b> .....	<b>15</b>
<b>5</b>	<b>Ordering information</b> .....	<b>18</b>
	<b>Revision history</b> .....	<b>19</b>

**IMPORTANT NOTICE – PLEASE READ CAREFULLY**

STMicroelectronics NV and its subsidiaries (“ST”) reserve the right to make changes, corrections, enhancements, modifications, and improvements to ST products and/or to this document at any time without notice. Purchasers should obtain the latest relevant information on ST products before placing orders. ST products are sold pursuant to ST’s terms and conditions of sale in place at the time of order acknowledgement.

Purchasers are solely responsible for the choice, selection, and use of ST products and ST assumes no liability for application assistance or the design of Purchasers’ products.

No license, express or implied, to any intellectual property right is granted by ST herein.

Resale of ST products with provisions different from the information set forth herein shall void any warranty granted by ST for such product.

ST and the ST logo are trademarks of ST. For additional information about ST trademarks, please refer to [www.st.com/trademarks](http://www.st.com/trademarks). All other product or service names are the property of their respective owners.

Information in this document supersedes and replaces information previously supplied in any prior versions of this document.

© 2019 STMicroelectronics – All rights reserved