

Trench gate field-stop IGBTs, M series 650 V, 30 A low-loss in TO-247 and TO-247 long leads packages

Datasheet - production data

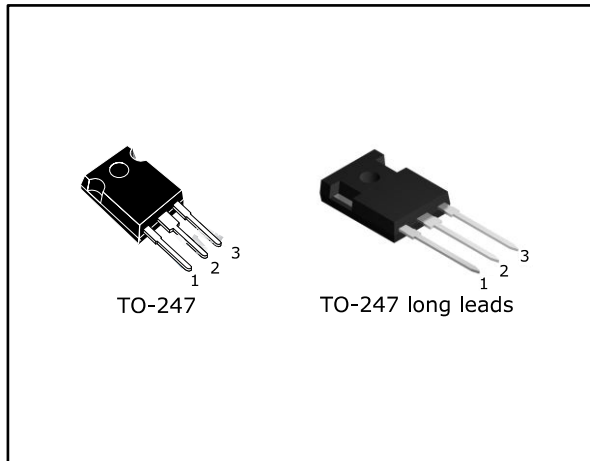
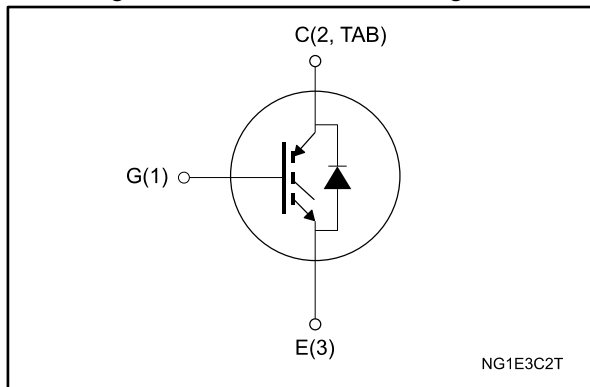

Figure 1: Internal schematic diagram



Features

- 6 μ s of minimum short-circuit withstand time
- $V_{CE(sat)} = 1.55$ V (typ.) @ $I_C = 30$ A
- Tight parameters distribution
- Safer paralleling
- Low thermal resistance
- Soft and very fast recovery antiparallel diode

Applications

- Motor control
- UPS
- PFC

Description

These devices are IGBTs developed using an advanced proprietary trench gate field-stop structure. The devices are part of the M series IGBTs, which represent an optimal balance between inverter system performance and efficiency where low-loss and short-circuit functionality are essential. Furthermore, the positive $V_{CE(sat)}$ temperature coefficient and tight parameter distribution result in safer paralleling operation.

Table 1: Device summary

Order code	Marking	Package	Packaging
STGW30M65DF2	G30M65DF2	TO-247	Tube
STGWA30M65DF2	G30M65DF2	TO-247 long leads	Tube

Contents

1	Electrical ratings	3
2	Electrical characteristics	4
	2.1 Electrical characteristics (curves)	6
3	Test circuits	11
4	Package information	12
	4.1 TO-247 package information	12
	4.2 TO-247 long leads package information	14
5	Revision history	16

1 Electrical ratings

Table 2: Absolute maximum ratings

Symbol	Parameter	Value	Unit
V_{CES}	Collector-emitter voltage ($V_{GE} = 0$ V)	650	V
I_C	Continuous collector current at $T_C = 25$ °C	60	A
I_C	Continuous collector current at $T_C = 100$ °C	30	A
$I_{CP}^{(1)}$	Pulsed collector current	120	A
V_{GE}	Gate-emitter voltage	±20	V
I_F	Continuous forward current at $T_C = 25$ °C	60	A
I_F	Continuous forward current at $T_C = 100$ °C	30	A
$I_{FP}^{(1)}$	Pulsed forward current	120	A
P_{TOT}	Total dissipation at $T_C = 25$ °C	258	W
T_{STG}	Storage temperature range	-55 to 150	°C
T_J	Operating junction temperature range	-55 to 175	°C

Notes:

⁽¹⁾Pulse width limited by maximum junction temperature.

Table 3: Thermal data

Symbol	Parameter	Value	Unit
R_{thJC}	Thermal resistance junction-case IGBT	0.58	°C/W
R_{thJC}	Thermal resistance junction-case diode	1.47	°C/W
R_{thJA}	Thermal resistance junction-ambient	50	°C/W

2 Electrical characteristics

$T_C = 25\text{ °C}$ unless otherwise specified

Table 4: Static characteristics

Symbol	Parameter	Test conditions	Min.	Typ.	Max.	Unit
$V_{(BR)CES}$	Collector-emitter breakdown voltage	$V_{GE} = 0\text{ V}$, $I_C = 250\text{ }\mu\text{A}$	650			V
$V_{CE(sat)}$	Collector-emitter saturation voltage	$V_{GE} = 15\text{ V}$, $I_C = 30\text{ A}$		1.55	2.0	V
		$V_{GE} = 15\text{ V}$, $I_C = 30\text{ A}$, $T_J = 125\text{ °C}$		1.95		
		$V_{GE} = 15\text{ V}$, $I_C = 30\text{ A}$, $T_J = 175\text{ °C}$		2.1		
V_F	Forward on-voltage	$I_F = 30\text{ A}$		1.85	2.65	V
		$I_F = 30\text{ A}$, $T_J = 125\text{ °C}$		1.6		
		$I_F = 30\text{ A}$, $T_J = 175\text{ °C}$		1.5		
$V_{GE(th)}$	Gate threshold voltage	$V_{CE} = V_{GE}$, $I_C = 500\text{ }\mu\text{A}$	5	6	7	V
I_{CES}	Collector cut-off current	$V_{GE} = 0\text{ V}$, $V_{CE} = 650\text{ V}$			25	μA
I_{GES}	Gate-emitter leakage current	$V_{CE} = 0\text{ V}$, $V_{GE} = \pm 20\text{ V}$			± 250	μA

Table 5: Dynamic characteristics

Symbol	Parameter	Test conditions	Min.	Typ.	Max.	Unit
C_{ies}	Input capacitance	$V_{CE} = 25\text{ V}$, $f = 1\text{ MHz}$, $V_{GE} = 0\text{ V}$	-	2490	-	pF
C_{oes}	Output capacitance		-	143	-	
C_{res}	Reverse transfer capacitance		-	46	-	
Q_g	Total gate charge	$V_{CC} = 520\text{ V}$, $I_C = 30\text{ A}$, $V_{GE} = 0\text{ to }15\text{ V}$ (see Figure 30: "Gate charge test circuit")	-	80	-	nC
Q_{ge}	Gate-emitter charge		-	18	-	
Q_{gc}	Gate-collector charge		-	32	-	

Table 6: IGBT switching characteristics (inductive load)

Symbol	Parameter	Test conditions	Min.	Typ.	Max.	Unit
$t_{d(on)}$	Turn-on delay time	$V_{CE} = 400\text{ V}$, $I_C = 30\text{ A}$, $V_{GE} = 15\text{ V}$, $R_G = 10\ \Omega$ (see Figure 29: "Test circuit for inductive load switching")		31.6	-	ns
t_r	Current rise time			13.4	-	ns
$(di/dt)_{on}$	Turn-on current slope			1791	-	A/ μ s
$t_{d(off)}$	Turn-off-delay time			115	-	ns
t_f	Current fall time			110	-	ns
$E_{on}^{(1)}$	Turn-on switching energy			0.3	-	mJ
$E_{off}^{(2)}$	Turn-off switching energy			0.96	-	mJ
E_{ts}	Total switching energy			1.26	-	mJ
$t_{d(on)}$	Turn-on delay time	$V_{CE} = 400\text{ V}$, $I_C = 30\text{ A}$, $V_{GE} = 15\text{ V}$, $R_G = 10\ \Omega$, $T_J = 175\text{ }^\circ\text{C}$ (see Figure 29: "Test circuit for inductive load switching")		30	-	ns
t_r	Current rise time			17	-	ns
$(di/dt)_{on}$	Turn-on current slope			1435	-	A/ μ s
$t_{d(off)}$	Turn-off-delay time			116	-	ns
t_f	Current fall time			194	-	ns
$E_{on}^{(1)}$	Turn-on switching energy			0.67	-	mJ
$E_{off}^{(2)}$	Turn-off switching energy			1.36	-	mJ
E_{ts}	Total switching energy			2.03	-	mJ
t_{sc}	Short-circuit withstand time	$V_{CC} \leq 400\text{ V}$, $V_{GE} = 13\text{ V}$, $T_{Jstart} = 150\text{ }^\circ\text{C}$	10		-	μ s
		$V_{CC} \leq 400\text{ V}$, $V_{GE} = 15\text{ V}$, $T_{Jstart} = 150\text{ }^\circ\text{C}$	6		-	

Notes:

(1)Including the reverse recovery of the diode.

(2)Including the tail of the collector current.

Table 7: Diode switching characteristics (inductive load)

Symbol	Parameter	Test conditions	Min.	Typ.	Max.	Unit
t_{rr}	Reverse recovery time	$I_F = 30\text{ A}$, $V_R = 400\text{ V}$, $V_{GE} = 15\text{ V}$, $di/dt = 1000\text{ A}/\mu\text{s}$ (see Figure 29: "Test circuit for inductive load switching")	-	140	-	ns
Q_{rr}	Reverse recovery charge		-	880	-	nC
I_{rrm}	Reverse recovery current		-	17	-	A
dl_{rr}/dt	Peak rate of fall of reverse recovery current during t_b		-	650	-	A/ μ s
E_{rr}	Reverse recovery energy		-	115	-	μ J
t_{rr}	Reverse recovery time	$I_F = 30\text{ A}$, $V_R = 400\text{ V}$, $V_{GE} = 15\text{ V}$, $di/dt = 1000\text{ A}/\mu\text{s}$, $T_J = 175\text{ }^\circ\text{C}$ (see Figure 29: "Test circuit for inductive load switching")	-	244	-	ns
Q_{rr}	Reverse recovery charge		-	2743	-	nC
I_{rrm}	Reverse recovery current		-	25	-	A
dl_{rr}/dt	Peak rate of fall of reverse recovery current during t_b		-	220	-	A/ μ s
E_{rr}	Reverse recovery energy		-	320	-	μ J

2.1 Electrical characteristics (curves)

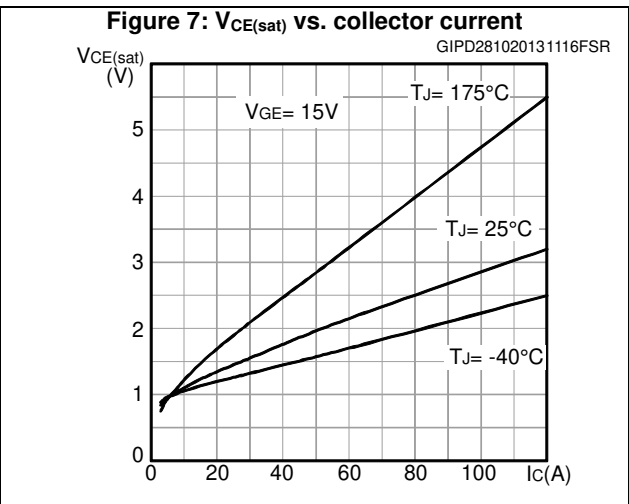
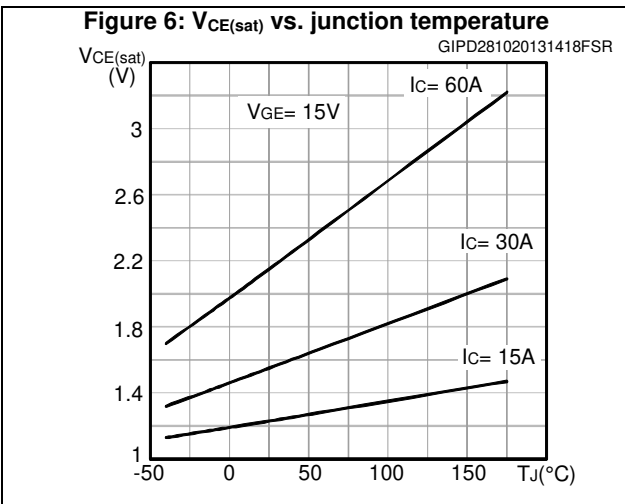
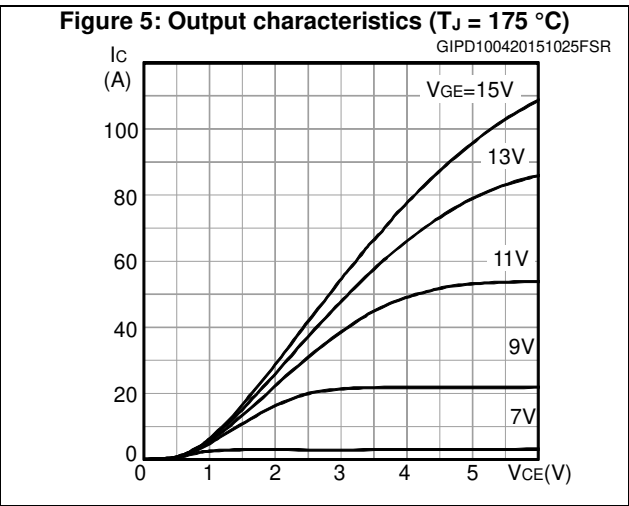
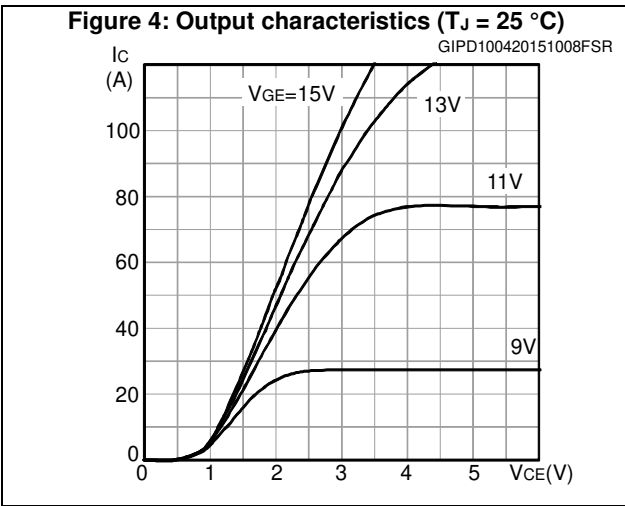
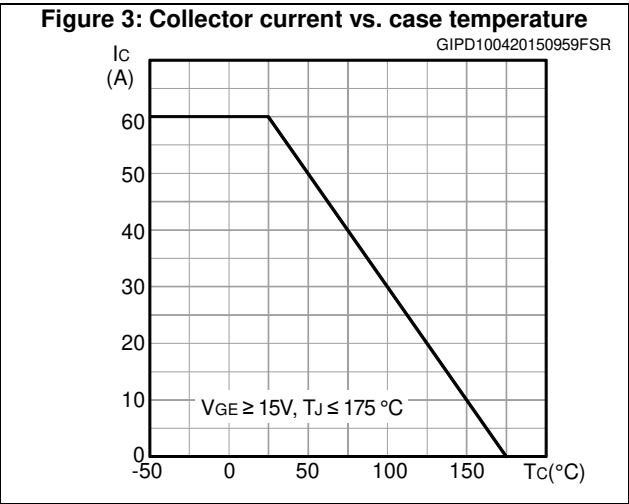
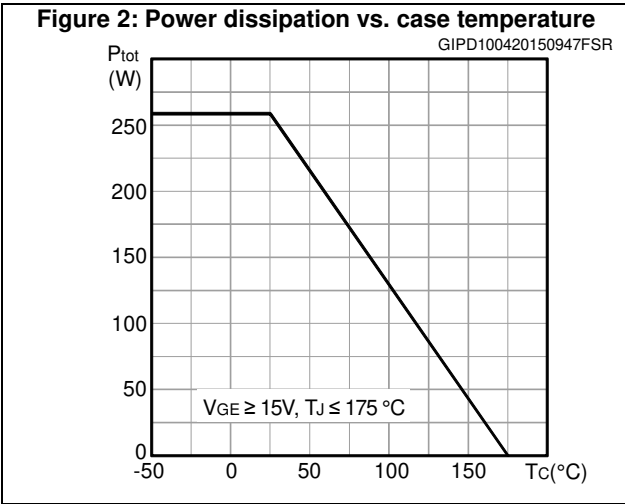

Figure 8: Collector current vs. switching frequency

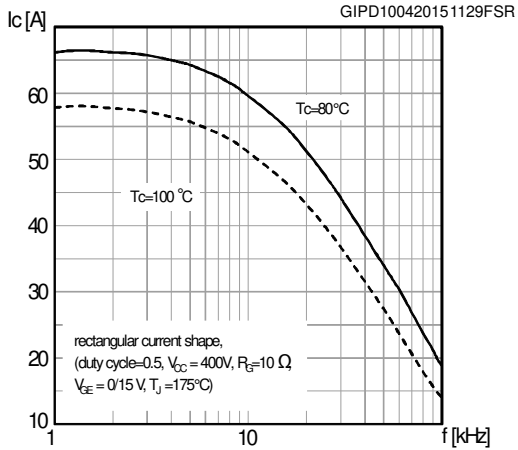

Figure 9: Forward bias safe operating area

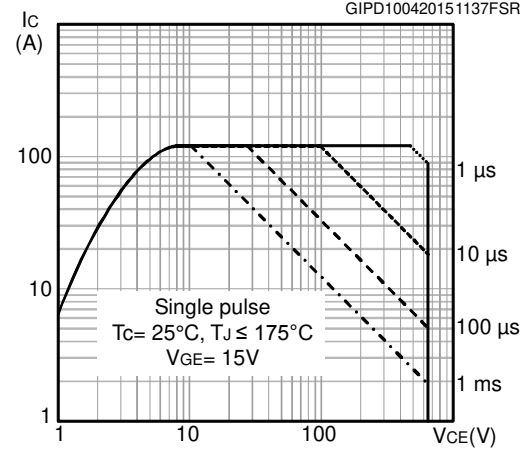

Figure 10: Transfer characteristics

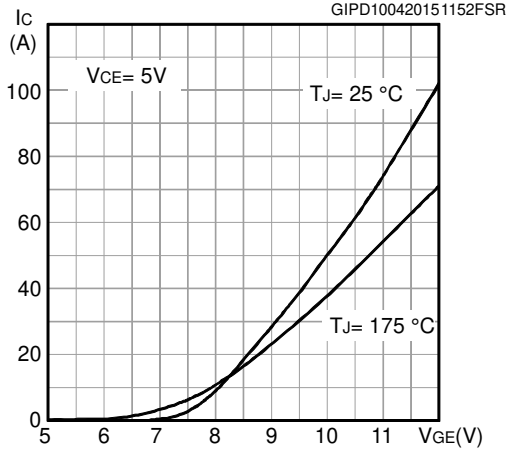

Figure 11: Diode V_F vs. forward current

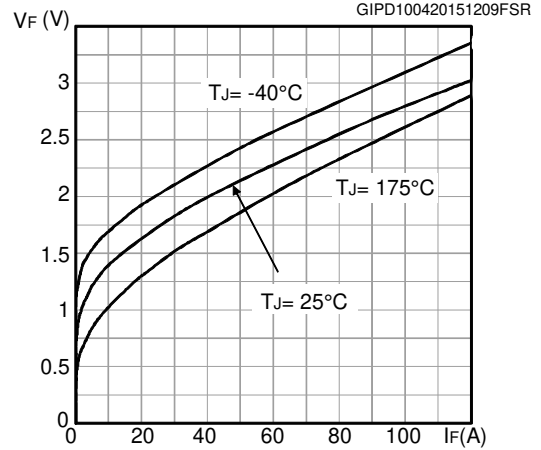

Figure 12: Normalized VGE(th) vs. junction temperature

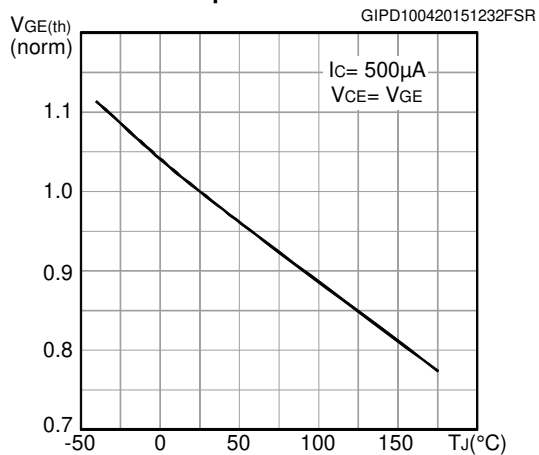
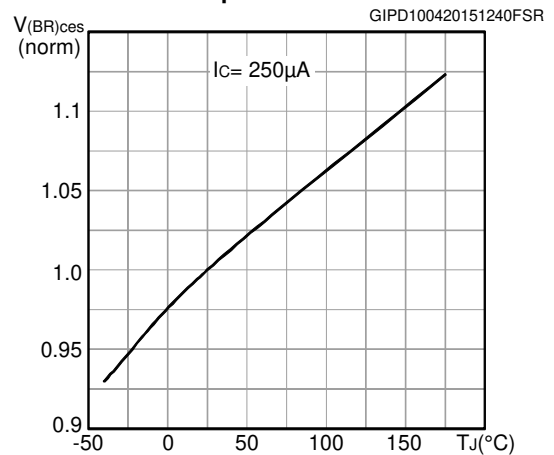
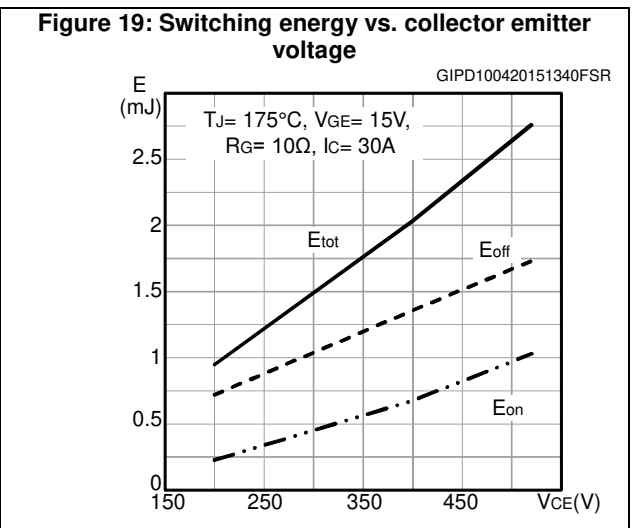
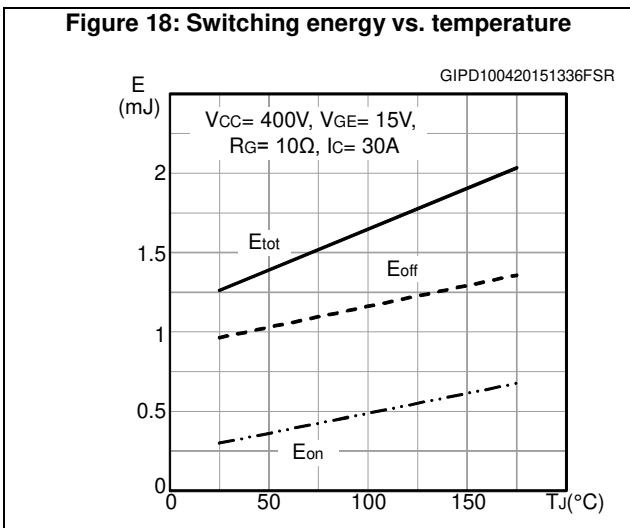
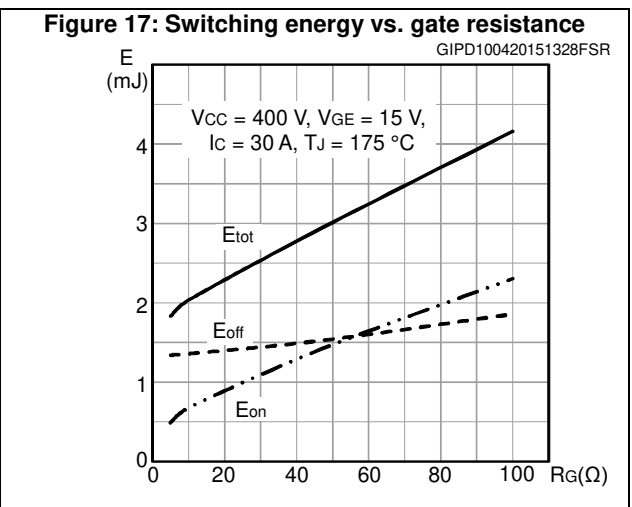
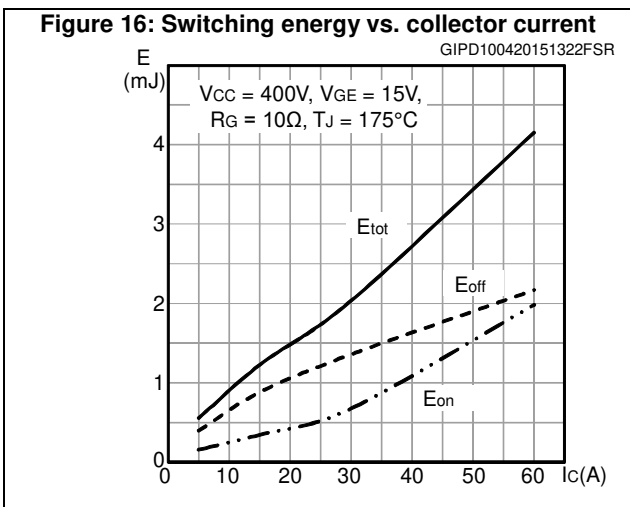
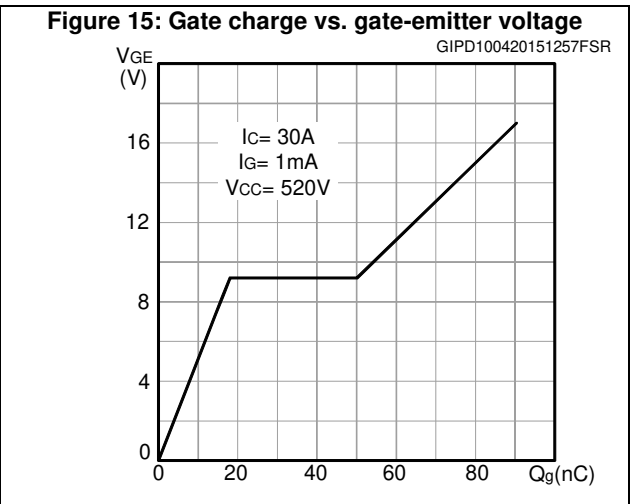
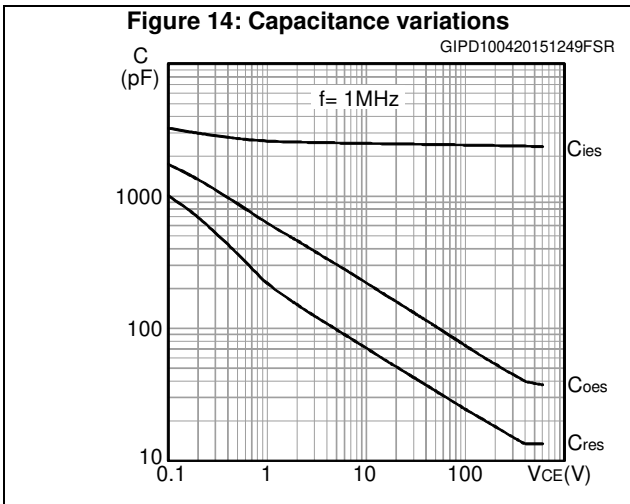

Figure 13: Normalized V(BR)CES vs. junction temperature



Electrical characteristics

STGW30M65DF2, STGWA30M65DF2



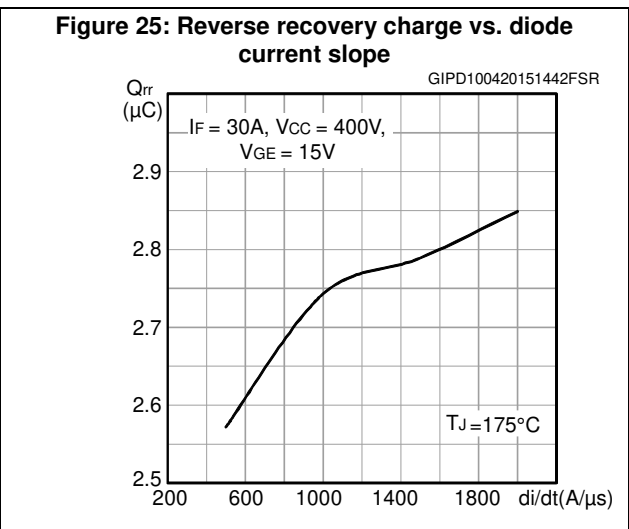
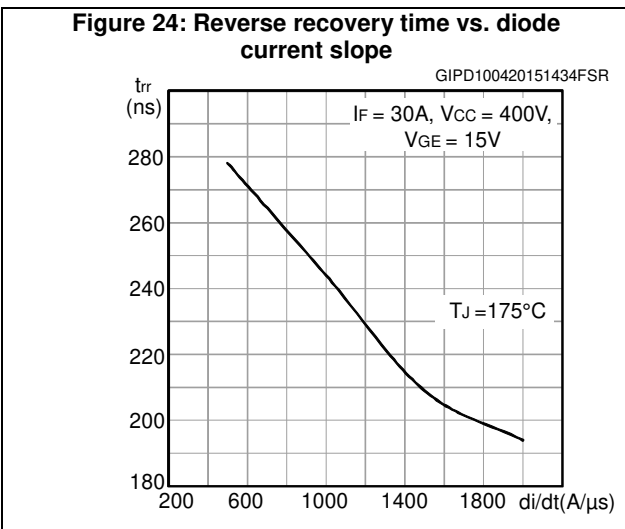
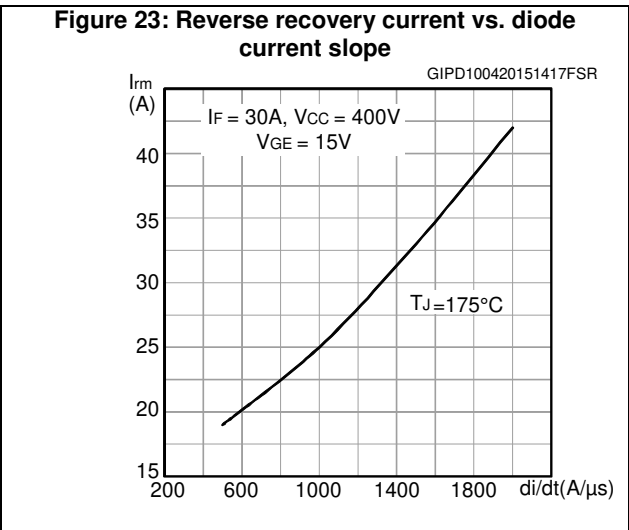
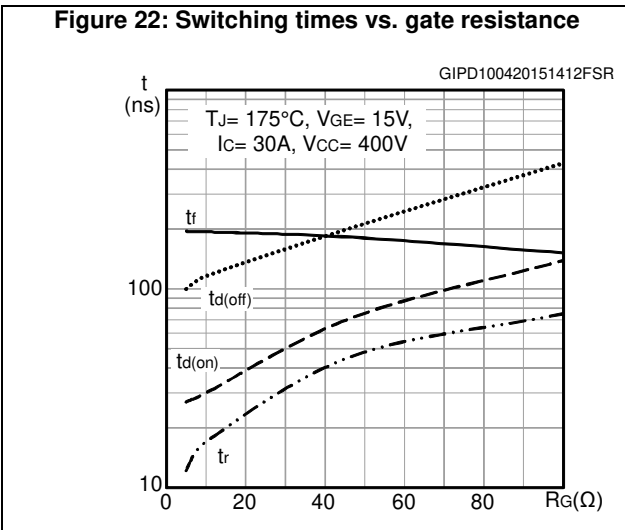
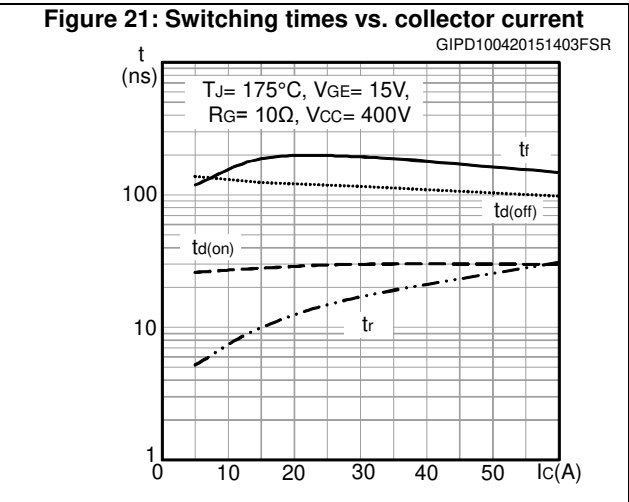
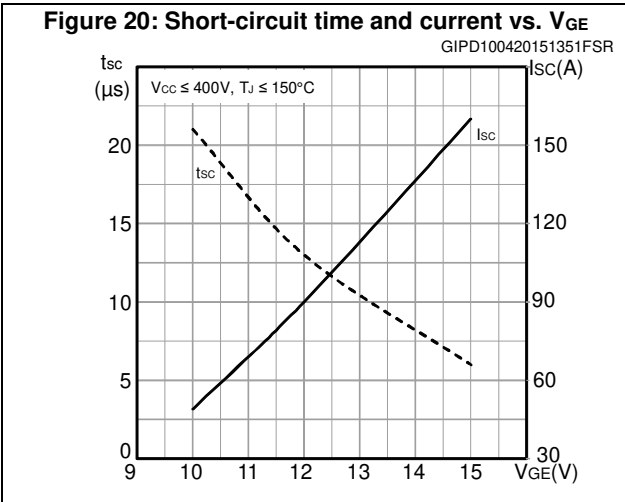

Figure 26: Reverse recovery energy vs. diode current slope

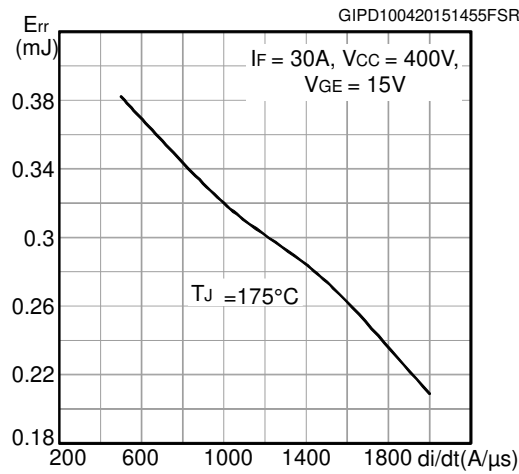

Figure 27: Thermal impedance for IGBT

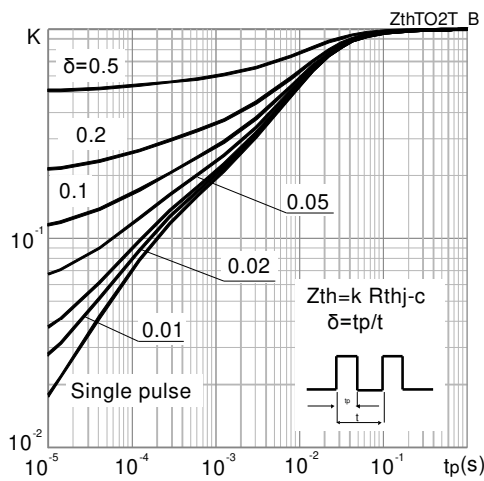
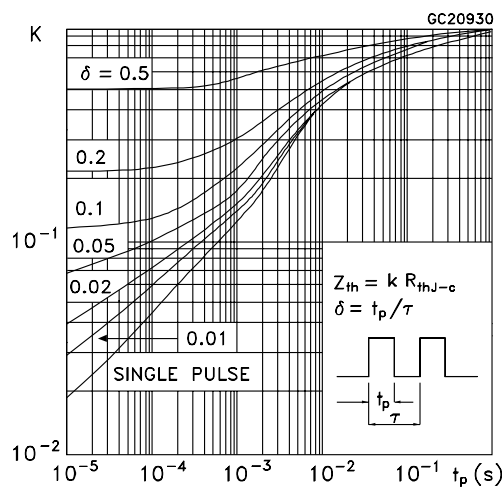

Figure 28: Thermal impedance for diode



4 Package information

In order to meet environmental requirements, ST offers these devices in different grades of ECOPACK® packages, depending on their level of environmental compliance. ECOPACK® specifications, grade definitions and product status are available at: www.st.com. ECOPACK® is an ST trademark.

4.1 TO-247 package information

Figure 33: TO-247 package outline

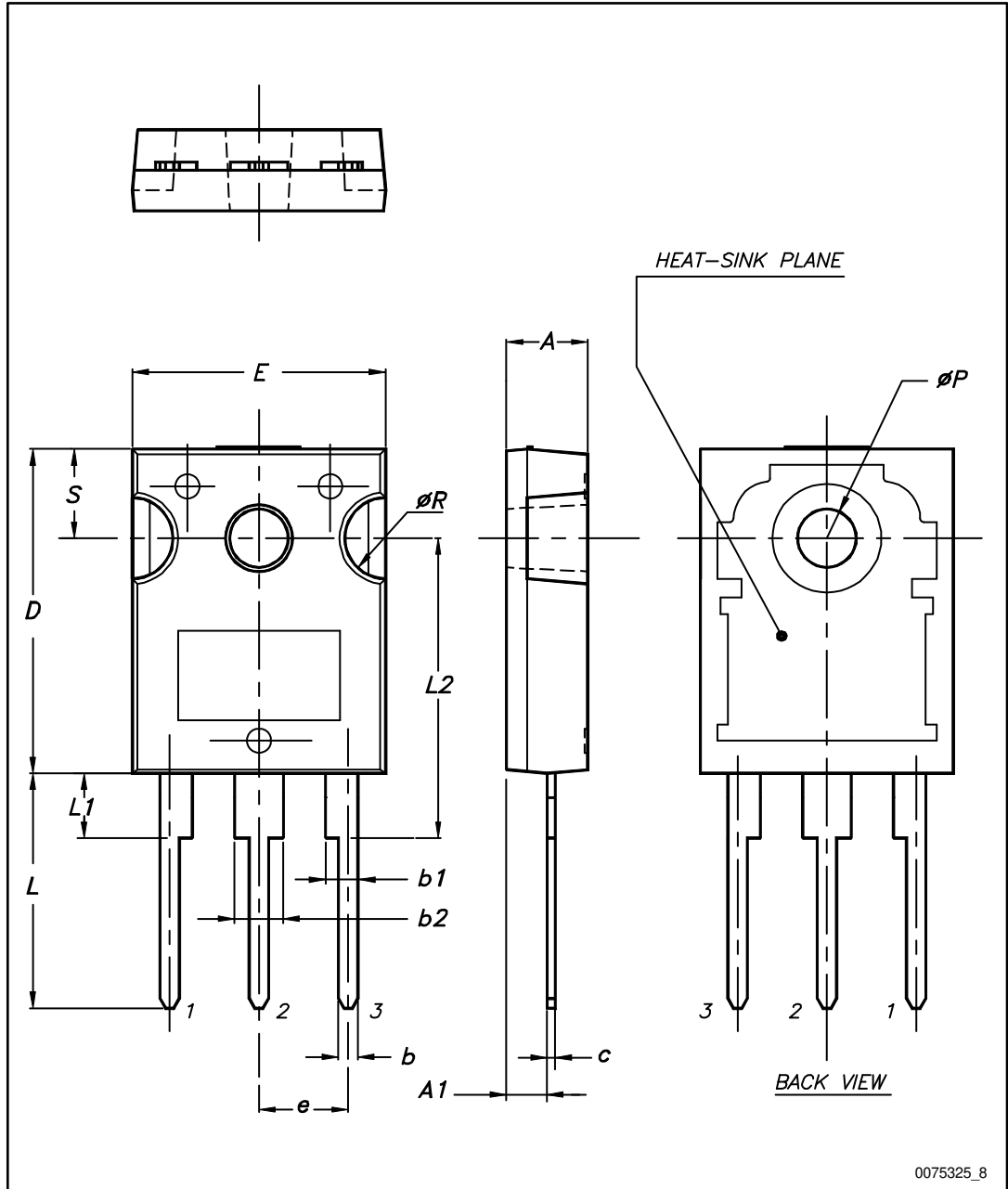

Table 8: TO-247 package mechanical data

Dim.	mm		
	Min.	Typ.	Max.
A	4.85		5.15
A1	2.20		2.60
b	1.0		1.40
b1	2.0		2.40
b2	3.0		3.40
c	0.40		0.80
D	19.85		20.15
E	15.45		15.75
e	5.30	5.45	5.60
L	14.20		14.80
L1	3.70		4.30
L2		18.50	
ØP	3.55		3.65
ØR	4.50		5.50
S	5.30	5.50	5.70

4.2 TO-247 long leads package information

Figure 34: TO-247 long leads package outline

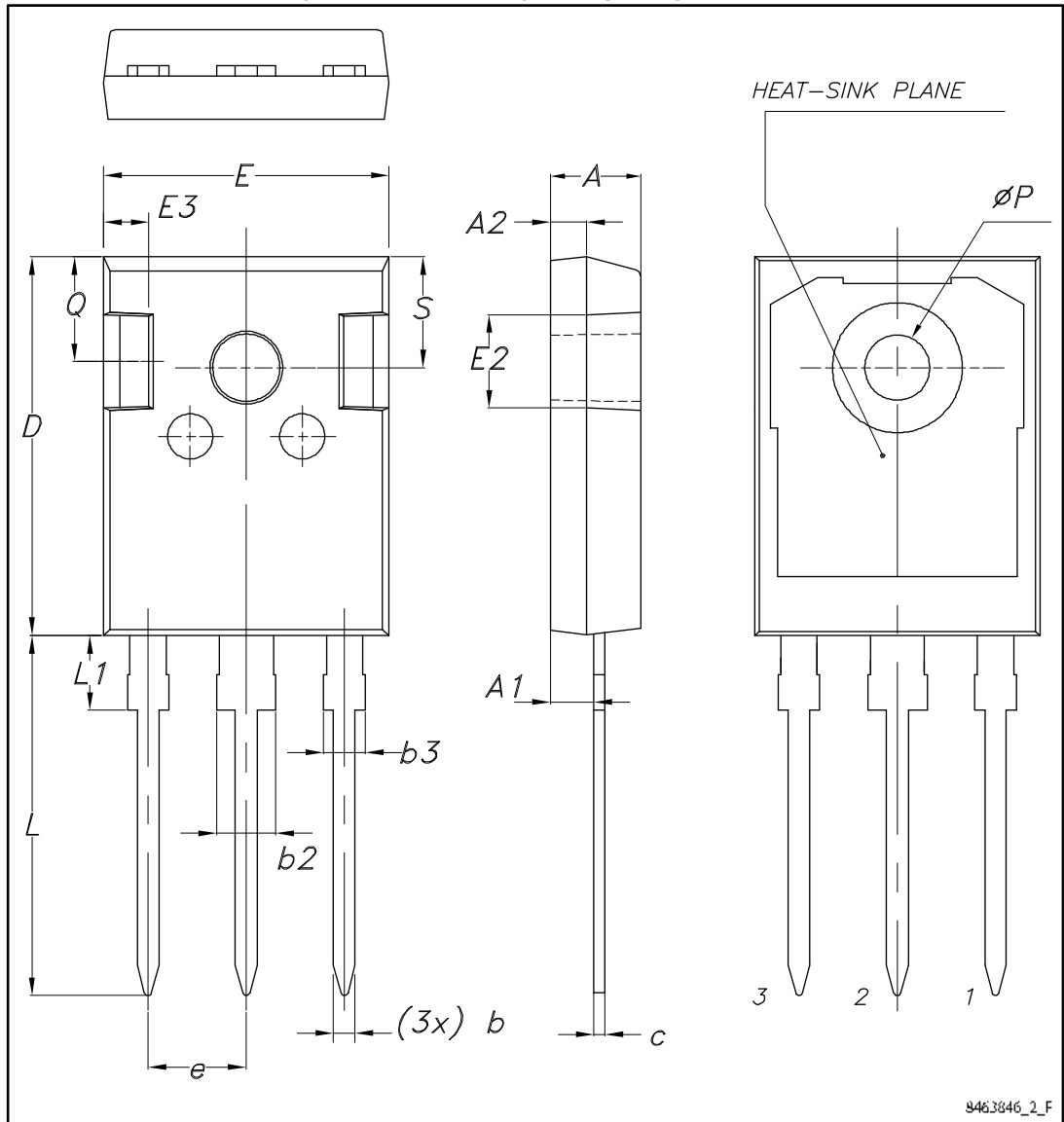

Table 9: TO-247 long leads package mechanical data

Dim.	mm		
	Min.	Typ.	Max.
A	4.90	5.00	5.10
A1	2.31	2.41	2.51
A2	1.90	2.00	2.10
b	1.16		1.26
b2			3.25
b3			2.25
c	0.59		0.66
D	20.90	21.00	21.10
E	15.70	15.80	15.90
E2	4.90	5.00	5.10
E3	2.40	2.50	2.60
e	5.34	5.44	5.54
L	19.80	19.92	20.10
L1			4.30
P	3.50	3.60	3.70
Q	5.60		6.00
S	6.05	6.15	6.25

5 Revision history

Table 10: Document revision history

Date	Revision	Changes
04-May-2015	1	First release.
14-Sep-2015	2	Updated features in cover page and added new t_{SC} condition in in <i>Table 6: "IGBT switching characteristics (inductive load)"</i> .
18-Dec-2015	3	Added part number STGW30M65DF2 Added <i>Section 4.1: "TO-247 package information"</i> Minor text changes.
20-May-2016	4	Updated features in cover page. Minor text changes
11-Apr-2017	5	Updated document title. Updated <i>Table 4: "Static characteristics"</i> , <i>Table 6: "IGBT switching characteristics (inductive load)"</i> and <i>Table 7: "Diode switching characteristics (inductive load)"</i> . Updated <i>Section 4: "Package information"</i> . Minor text changes

IMPORTANT NOTICE – PLEASE READ CAREFULLY

STMicroelectronics NV and its subsidiaries ("ST") reserve the right to make changes, corrections, enhancements, modifications, and improvements to ST products and/or to this document at any time without notice. Purchasers should obtain the latest relevant information on ST products before placing orders. ST products are sold pursuant to ST's terms and conditions of sale in place at the time of order acknowledgement.

Purchasers are solely responsible for the choice, selection, and use of ST products and ST assumes no liability for application assistance or the design of Purchasers' products.

No license, express or implied, to any intellectual property right is granted by ST herein.

Resale of ST products with provisions different from the information set forth herein shall void any warranty granted by ST for such product.

ST and the ST logo are trademarks of ST. All other product or service names are the property of their respective owners.

Information in this document supersedes and replaces information previously supplied in any prior versions of this document.

© 2017 STMicroelectronics – All rights reserved