

Trench gate field-stop IGBT, M series 650 V, 75 A low-loss in TO-247 and TO-247 long leads packages

Datasheet - production data

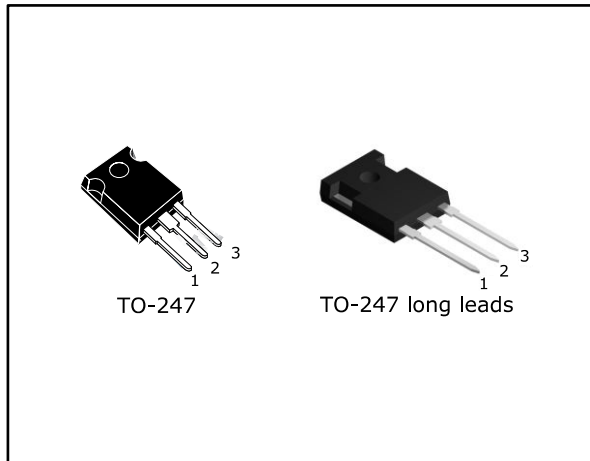
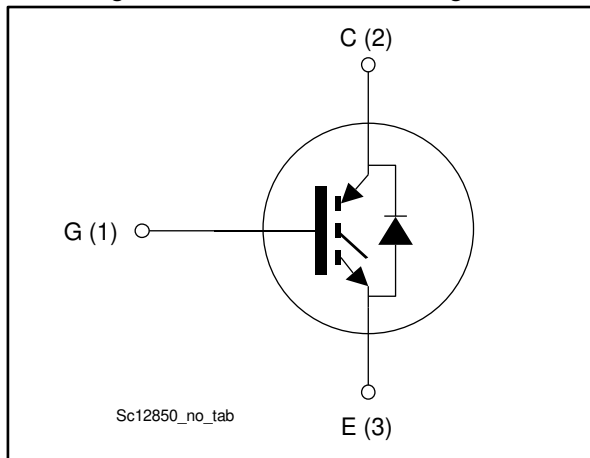

Figure 1: Internal schematic diagram



Features

- 6 μs of short-circuit withstand time
- $V_{CE(sat)} = 1.65 \text{ V (typ.) @ } I_c = 75 \text{ A}$
- Tight parameter distribution
- Safer paralleling
- Positive $V_{CE(sat)}$ temperature coefficient
- Low thermal resistance
- Soft and very fast recovery antiparallel diode
- Maximum junction temperature: $T_J = 175 \text{ }^\circ\text{C}$

Applications

- Motor control
- UPS
- PFC
- General purpose inverter

Description

These devices are IGBTs developed using an advanced proprietary trench gate field-stop structure. The devices are part of the M series IGBTs, which represent an optimal balance between inverter system performance and efficiency where low-loss and short-circuit functionality are essential. Furthermore, the positive $V_{CE(sat)}$ temperature coefficient and tight parameter distribution result in safer paralleling operation.

Table 1: Device summary

| Order code | Marking | Package | Packing |
|---------------|-----------|-------------------|---------|
| STGW75M65DF2 | G75M65DF2 | TO-247 | Tube |
| STGWA75M65DF2 | | TO-247 long leads | |

Contents

| | | |
|----------|---|-----------|
| 1 | Electrical ratings | 3 |
| 2 | Electrical characteristics | 4 |
| | 2.1 Electrical characteristics (curves) | 6 |
| 3 | Test circuits | 12 |
| 4 | Package information | 13 |
| | 4.1 TO-247 package information | 13 |
| | 4.2 TO-247 long leads package information | 15 |
| 5 | Revision history | 17 |

1 Electrical ratings

Table 2: Absolute maximum ratings

| Symbol | Parameter | Value | Unit |
|----------------|--|-------------|------|
| V_{CES} | Collector-emitter voltage ($V_{GE} = 0$ V) | 650 | V |
| $I_C^{(1)}$ | Continuous collector current at $T_C = 25$ °C | 120 | A |
| I_C | Continuous collector current at $T_C = 100$ °C | 75 | A |
| $I_{CP}^{(2)}$ | Pulsed collector current | 225 | A |
| V_{GE} | Gate-emitter voltage | ±20 | V |
| $I_F^{(1)}$ | Continuous forward current at $T_C = 25$ °C | 120 | A |
| I_F | Continuous forward current at $T_C = 100$ °C | 75 | A |
| $I_{FP}^{(2)}$ | Pulsed forward current | 225 | A |
| P_{TOT} | Total dissipation at $T_C = 25$ °C | 468 | W |
| T_{STG} | Storage temperature range | - 55 to 150 | °C |
| T_J | Operating junction temperature range | - 55 to 175 | °C |

Notes:

(1)Current level is limited by bond wires

(2)Pulse width limited by maximum junction temperature.

Table 3: Thermal data

| Symbol | Parameter | Value | Unit |
|------------|--|-------|------|
| R_{thJC} | Thermal resistance junction-case IGBT | 0.32 | °C/W |
| R_{thJC} | Thermal resistance junction-case diode | 0.74 | °C/W |
| R_{thJA} | Thermal resistance junction-ambient | 50 | °C/W |

2 Electrical characteristics

$T_C = 25\text{ °C}$ unless otherwise specified

Table 4: Static characteristics

| Symbol | Parameter | Test conditions | Min. | Typ. | Max. | Unit |
|---------------|--------------------------------------|---|------|------|-----------|---------------|
| $V_{(BR)CES}$ | Collector-emitter breakdown voltage | $V_{GE} = 0\text{ V}$, $I_C = 250\text{ }\mu\text{A}$ | 650 | | | V |
| $V_{CE(sat)}$ | Collector-emitter saturation voltage | $V_{GE} = 15\text{ V}$, $I_C = 75\text{ A}$ | | 1.65 | 2.1 | V |
| | | $V_{GE} = 15\text{ V}$, $I_C = 75\text{ A}$, $T_J = 125\text{ °C}$ | | 1.95 | | |
| | | $V_{GE} = 15\text{ V}$, $I_C = 75\text{ A}$, $T_J = 175\text{ °C}$ | | 2.1 | | |
| V_F | Forward on-voltage | $I_F = 75\text{ A}$ | | 2 | 2.85 | V |
| | | $I_F = 75\text{ A}$, $T_J = 125\text{ °C}$ | | 1.75 | | |
| | | $I_F = 75\text{ A}$, $T_J = 175\text{ °C}$ | | 1.6 | | |
| $V_{GE(th)}$ | Gate threshold voltage | $V_{CE} = V_{GE}$, $I_C = 2\text{ mA}$ | 5 | 6 | 7 | V |
| I_{CES} | Collector cut-off current | $V_{GE} = 0\text{ V}$, $V_{CE} = 650\text{ V}$ | | | 25 | μA |
| I_{GES} | Gate-emitter leakage current | $V_{CE} = 0\text{ V}$, $V_{GE} = \pm 20\text{ V}$ | | | ± 250 | μA |

Table 5: Dynamic characteristics

| Symbol | Parameter | Test conditions | Min. | Typ. | Max. | Unit |
|-----------|------------------------------|---|------|------|------|------|
| C_{ies} | Input capacitance | $V_{CE} = 25\text{ V}$, $f = 1\text{ MHz}$, $V_{GE} = 0\text{ V}$ | - | 6290 | - | pF |
| C_{oes} | Output capacitance | | - | 390 | - | |
| C_{res} | Reverse transfer capacitance | | - | 136 | - | |
| Q_g | Total gate charge | $V_{CC} = 520\text{ V}$, $I_C = 75\text{ A}$, $V_{GE} = 0\text{ to }15\text{ V}$ (see Figure 30: "Gate charge test circuit") | - | 225 | - | nC |
| Q_{ge} | Gate-emitter charge | | - | 53 | - | |
| Q_{gc} | Gate-collector charge | | - | 87 | - | |

Table 6: IGBT switching characteristics (inductive load)

| Symbol | Parameter | Test conditions | Min. | Typ. | Max. | Unit |
|-----------------|------------------------------|---|------|------|------|------------|
| $t_{d(on)}$ | Turn-on delay time | $V_{CE} = 400\text{ V}$, $I_C = 75\text{ A}$, $V_{GE} = 15\text{ V}$, $R_G = 3.3\ \Omega$ (see Figure 29: "Test circuit for inductive load switching") | | 47 | - | ns |
| t_r | Current rise time | | | 22.4 | - | ns |
| $(di/dt)_{on}$ | Turn-on current slope | | | 2680 | - | A/ μ s |
| $t_{d(off)}$ | Turn-off-delay time | | | 125 | - | ns |
| t_f | Current fall time | | | 93 | - | ns |
| $E_{on}^{(1)}$ | Turn-on switching energy | | | 0.69 | - | mJ |
| $E_{off}^{(2)}$ | Turn-off switching energy | | | 2.54 | - | mJ |
| E_{ts} | Total switching energy | | | 3.23 | - | mJ |
| $t_{d(on)}$ | Turn-on delay time | $V_{CE} = 400\text{ V}$, $I_C = 75\text{ A}$, $V_{GE} = 15\text{ V}$, $R_G = 3.3\ \Omega$ $T_J = 175\text{ }^\circ\text{C}$ (see Figure 29: "Test circuit for inductive load switching") | | 48 | - | ns |
| t_r | Current rise time | | | 25 | - | ns |
| $(di/dt)_{on}$ | Turn-on current slope | | | 2420 | - | A/ μ s |
| $t_{d(off)}$ | Turn-off-delay time | | | 125 | - | ns |
| t_f | Current fall time | | | 167 | - | ns |
| $E_{on}^{(1)}$ | Turn-on switching energy | | | 2.17 | - | mJ |
| $E_{off}^{(2)}$ | Turn-off switching energy | | | 3.45 | - | mJ |
| E_{ts} | Total switching energy | | | 5.62 | - | mJ |
| t_{sc} | Short-circuit withstand time | $V_{CC} \leq 400\text{ V}$, $V_{GE} = 13\text{ V}$, $T_{Jstart} \leq 150\text{ }^\circ\text{C}$ | 10 | | - | μ s |
| | | $V_{CC} \leq 400\text{ V}$, $V_{GE} = 15\text{ V}$, $T_{Jstart} \leq 150\text{ }^\circ\text{C}$ | 6 | | | |

Notes:

(1)Including the reverse recovery of the diode.

(2)Including the tail of the collector current.

Table 7: Diode switching characteristics (inductive load)

| Symbol | Parameter | Test conditions | Min. | Typ. | Max. | Unit |
|--------------|--|---|------|------|------|------------|
| t_{rr} | Reverse recovery time | $I_F = 75\text{ A}$, $V_R = 400\text{ V}$, $V_{GE} = 15\text{ V}$, $di/dt = 1000\text{ A}/\mu\text{s}$ (see Figure 29: "Test circuit for inductive load switching") | - | 165 | - | ns |
| Q_{rr} | Reverse recovery charge | | - | 1.72 | - | μ C |
| I_{rrm} | Reverse recovery current | | - | 25 | - | A |
| dl_{rr}/dt | Peak rate of fall of reverse recovery current during t_b | | - | 750 | - | A/ μ s |
| E_{rr} | Reverse recovery energy | | - | 289 | - | μ J |
| t_{rr} | Reverse recovery time | $I_F = 75\text{ A}$, $V_R = 400\text{ V}$, $V_{GE} = 15\text{ V}$, $di/dt = 1000\text{ A}/\mu\text{s}$, $T_J = 175\text{ }^\circ\text{C}$ (see Figure 29: "Test circuit for inductive load switching") | - | 256 | - | ns |
| Q_{rr} | Reverse recovery charge | | - | 6.85 | - | μ C |
| I_{rrm} | Reverse recovery current | | - | 48 | - | A |
| dl_{rr}/dt | Peak rate of fall of reverse recovery current during t_b | | - | 300 | - | A/ μ s |
| E_{rr} | Reverse recovery energy | | - | 1033 | - | μ J |

2.1 Electrical characteristics (curves)

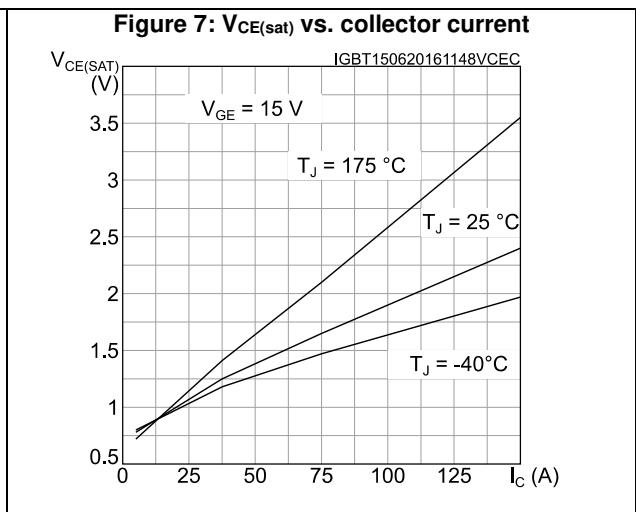
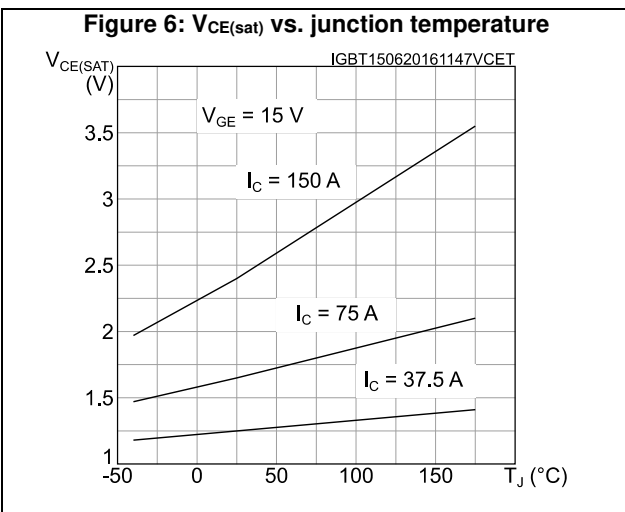
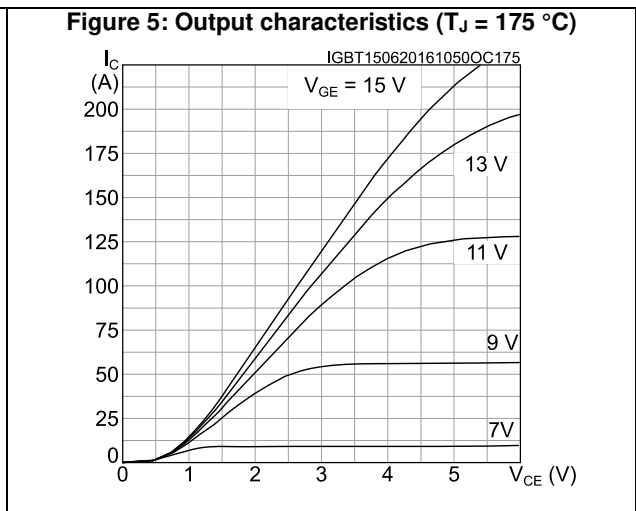
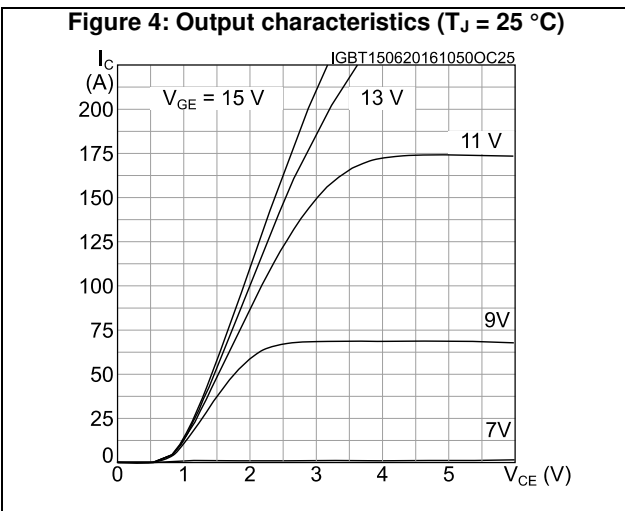
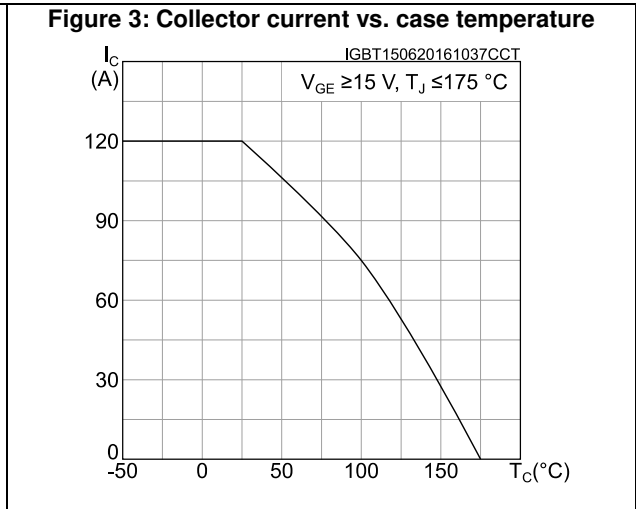
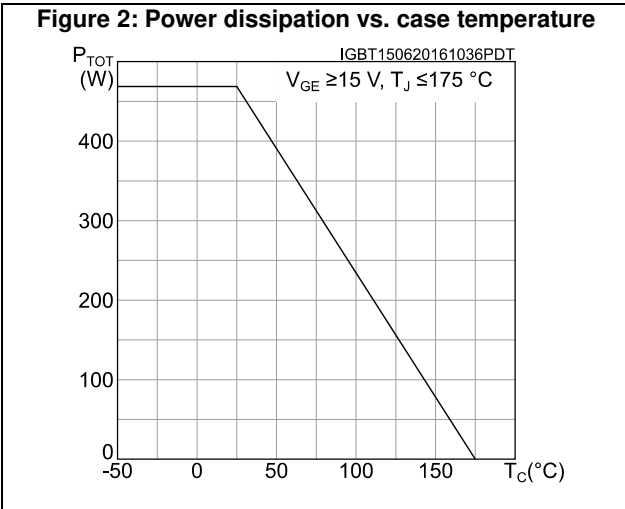

Figure 8: Collector current vs. switching frequency

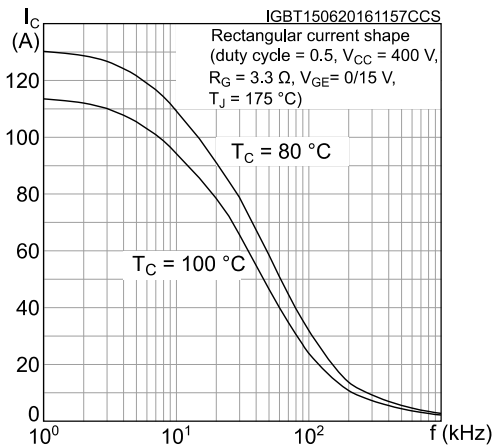

Figure 9: Forward bias safe operating area

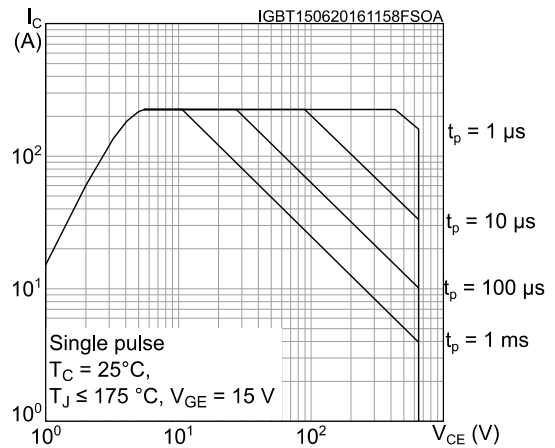

Figure 10: Transfer characteristics

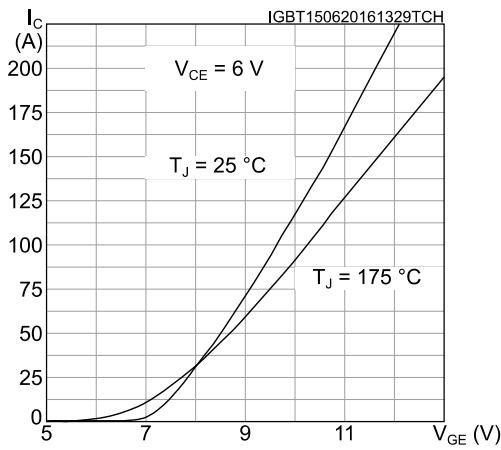

Figure 11: Diode V_F vs. forward current

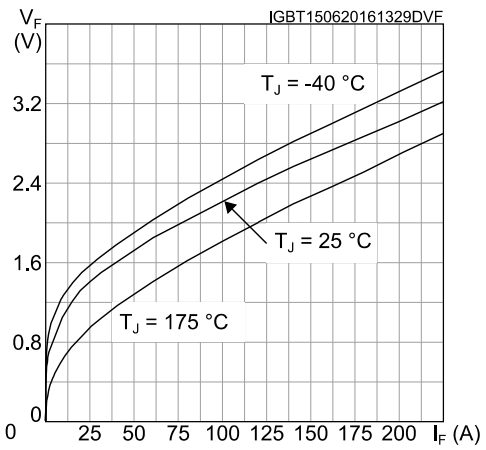

Figure 12: Normalized V_GE(th) vs. junction temperature

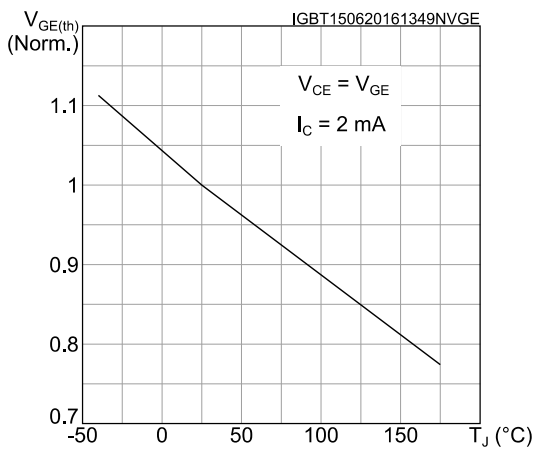
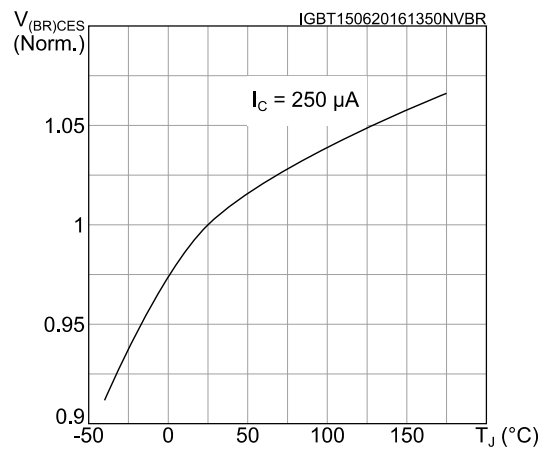
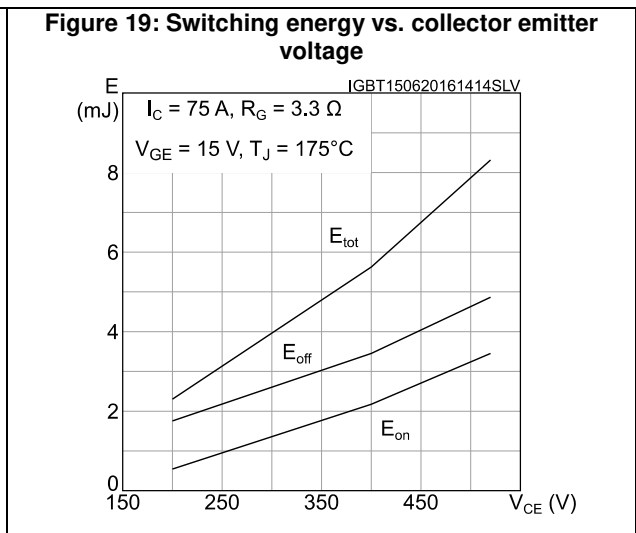
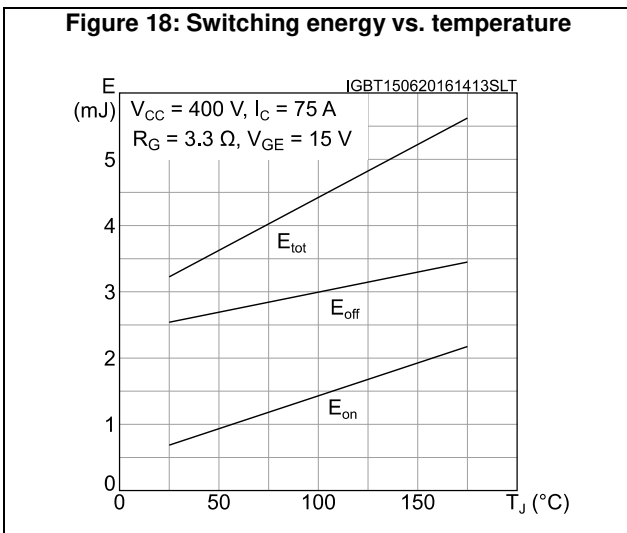
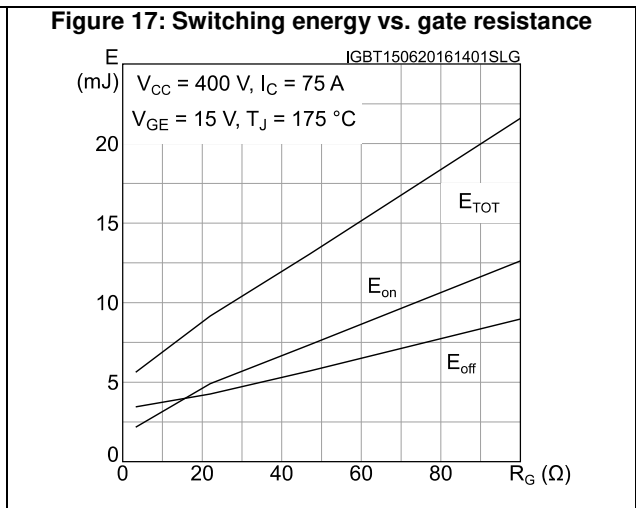
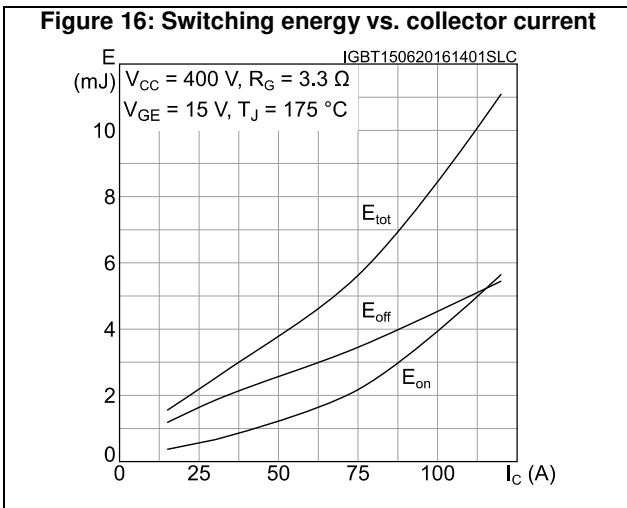
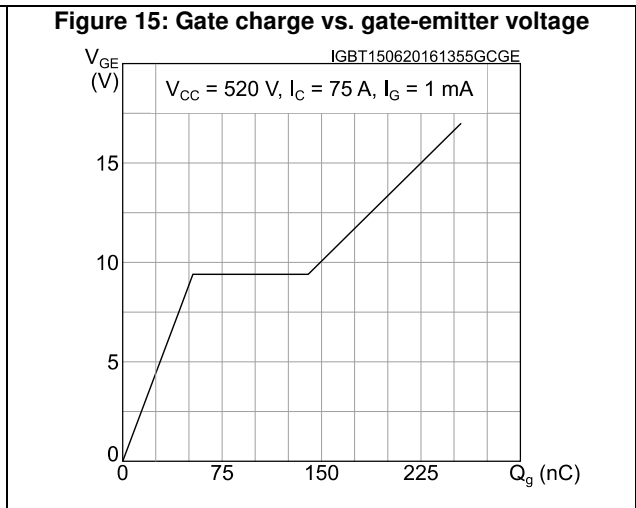
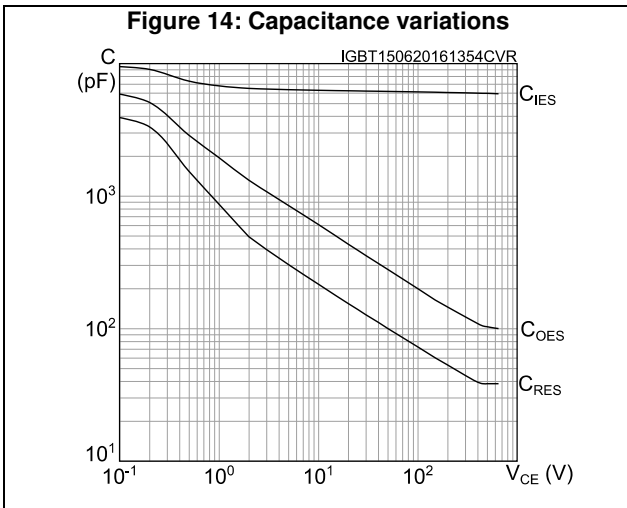

Figure 13: Normalized V_BR(CES) vs. junction temperature



Electrical characteristics

STGW75M65DF2, STGWA75M65DF2



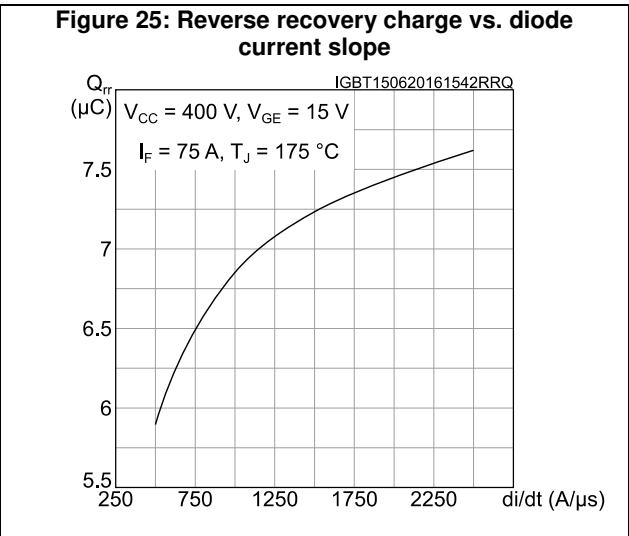
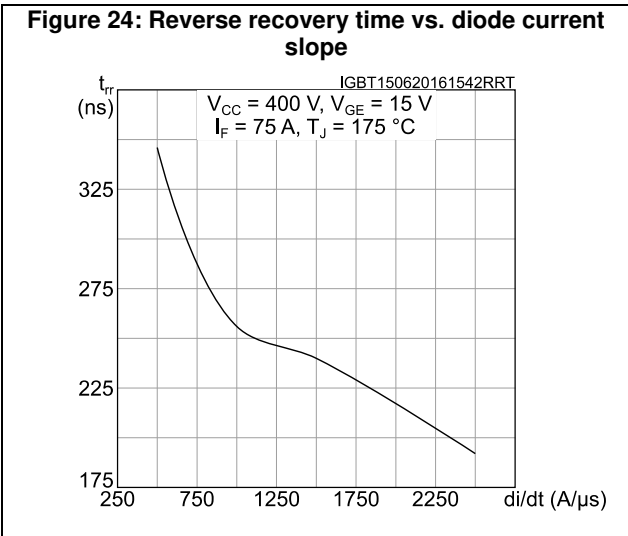
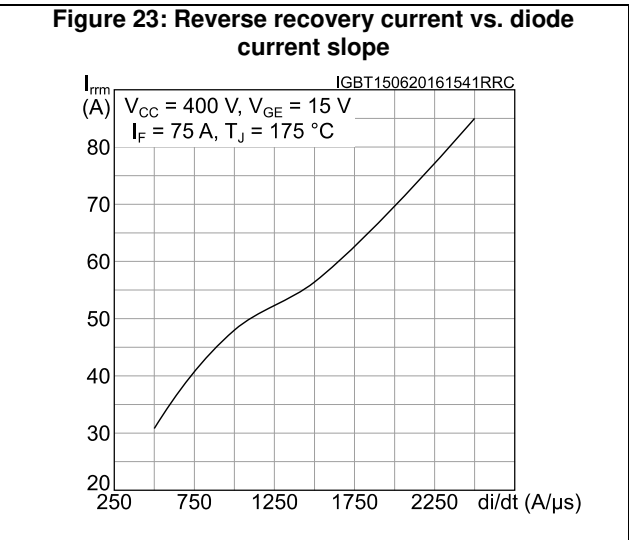
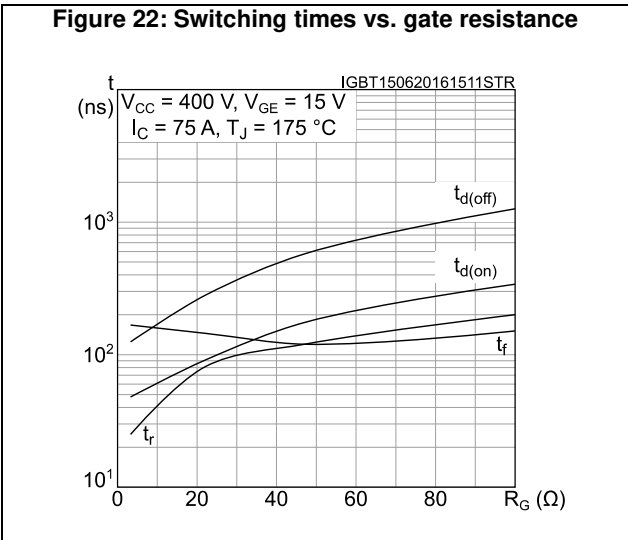
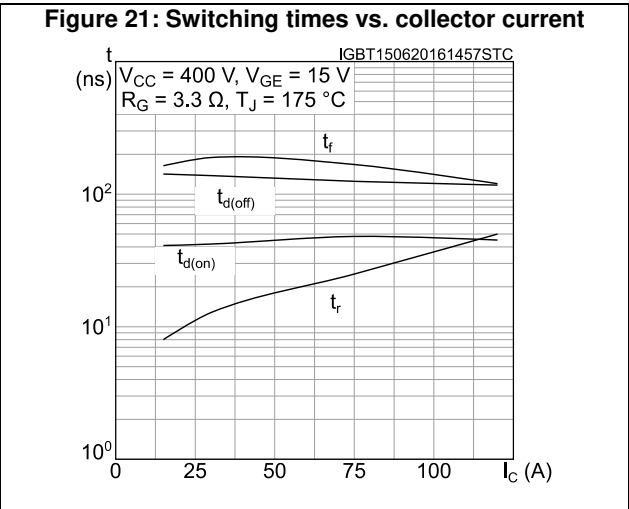
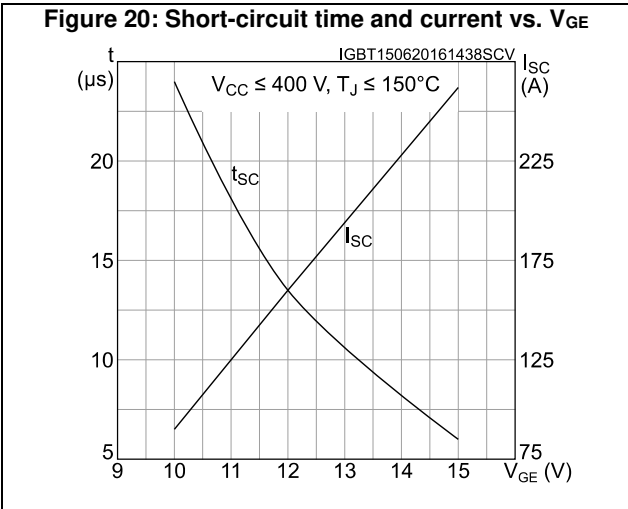

Figure 26: Reverse recovery energy vs. diode current slope

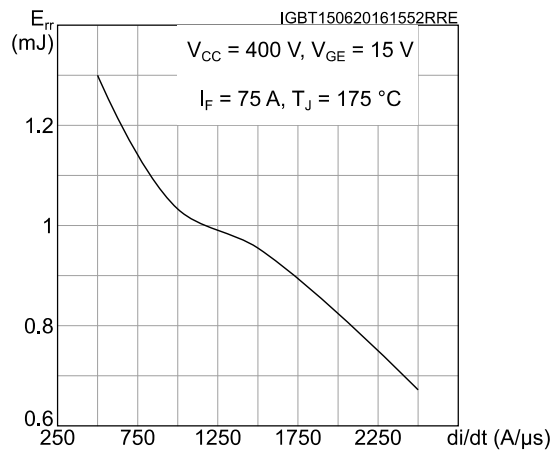

Figure 27: Thermal impedance for IGBT

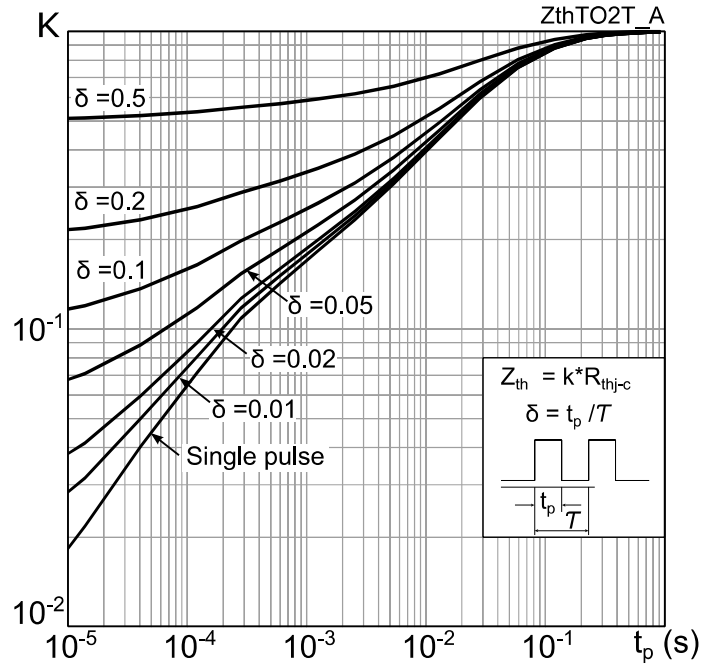
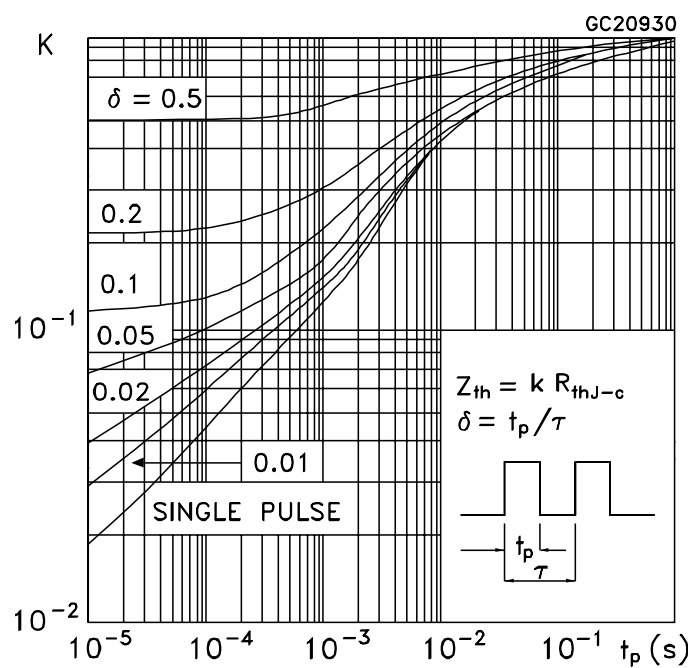
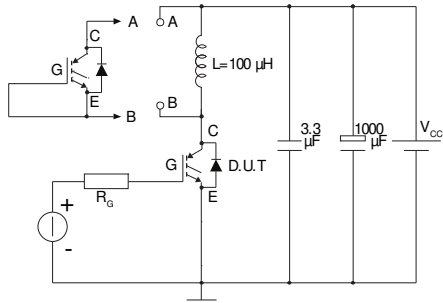

Figure 28: Thermal impedance for diode



3 Test circuits

Figure 29: Test circuit for inductive load switching



AM01504v1

Figure 30: Gate charge test circuit

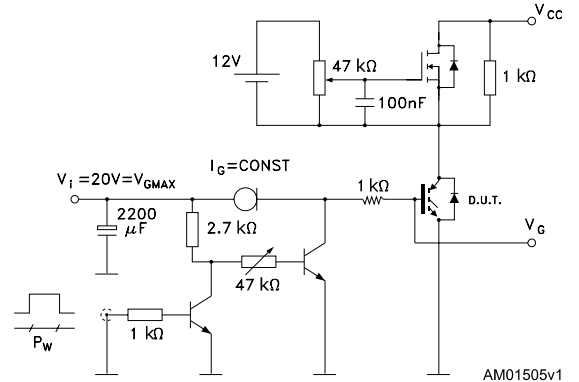

AM01505v1

Figure 31: Switching waveform

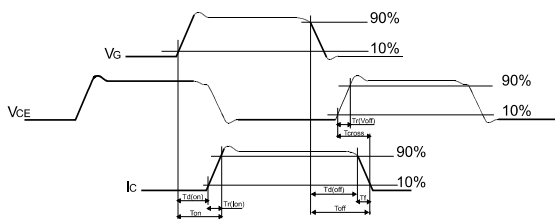

AM01506v1

Figure 32: Diode reverse recovery waveform

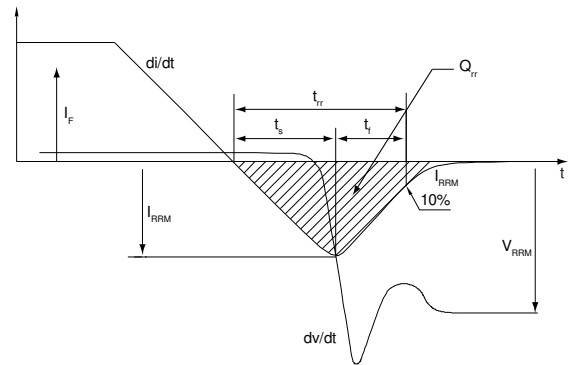

AM01507v1

4 Package information

In order to meet environmental requirements, ST offers these devices in different grades of ECOPACK® packages, depending on their level of environmental compliance. ECOPACK® specifications, grade definitions and product status are available at: www.st.com. ECOPACK® is an ST trademark.

4.1 TO-247 package information

Figure 33: TO-247 package outline

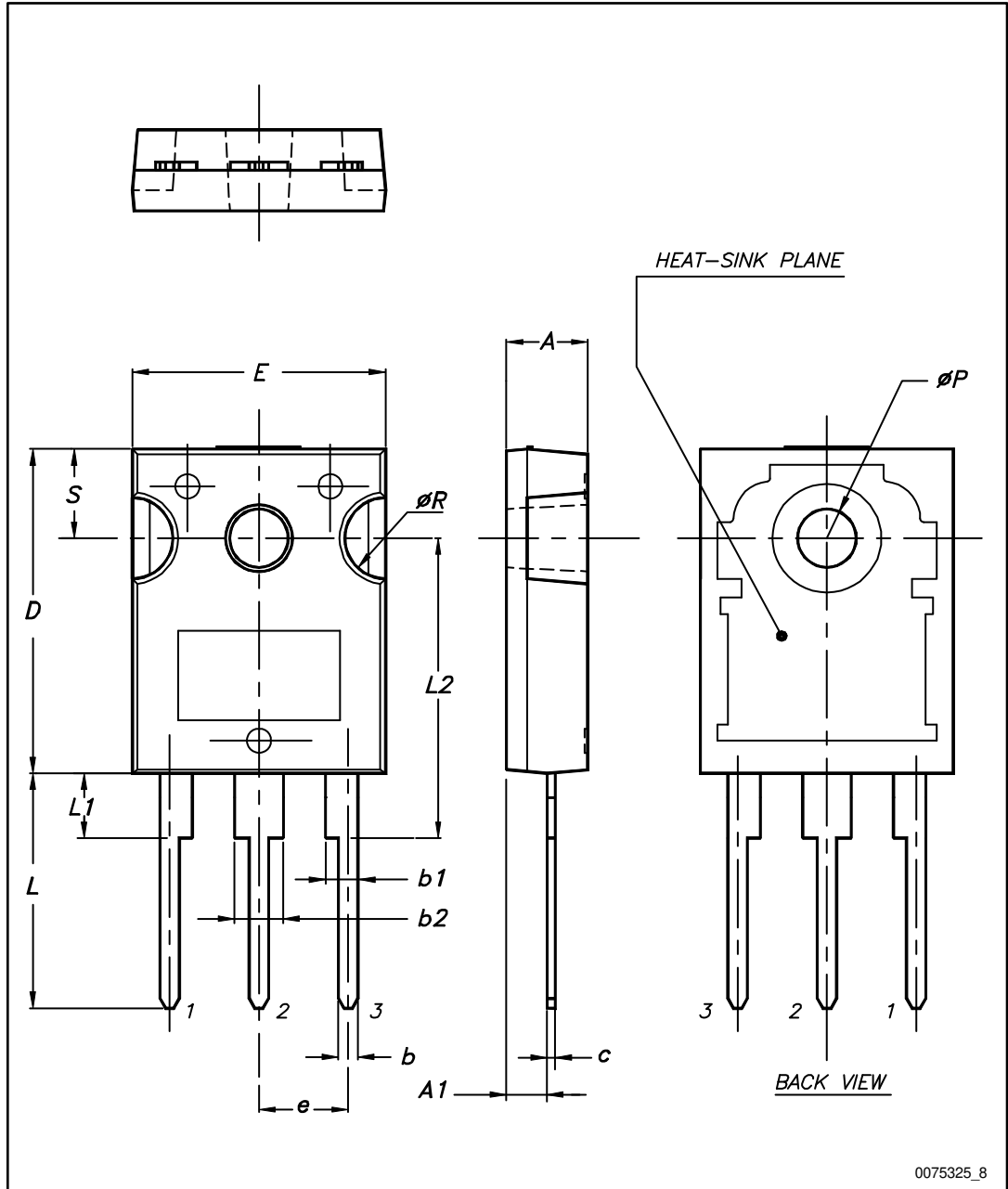

Table 8: TO-247 package mechanical data

| Dim. | mm | | |
|------|-------|-------|-------|
| | Min. | Typ. | Max. |
| A | 4.85 | | 5.15 |
| A1 | 2.20 | | 2.60 |
| b | 1.0 | | 1.40 |
| b1 | 2.0 | | 2.40 |
| b2 | 3.0 | | 3.40 |
| c | 0.40 | | 0.80 |
| D | 19.85 | | 20.15 |
| E | 15.45 | | 15.75 |
| e | 5.30 | 5.45 | 5.60 |
| L | 14.20 | | 14.80 |
| L1 | 3.70 | | 4.30 |
| L2 | | 18.50 | |
| ØP | 3.55 | | 3.65 |
| ØR | 4.50 | | 5.50 |
| S | 5.30 | 5.50 | 5.70 |

4.2 TO-247 long leads package information

Figure 34: TO-247 long leads package outline

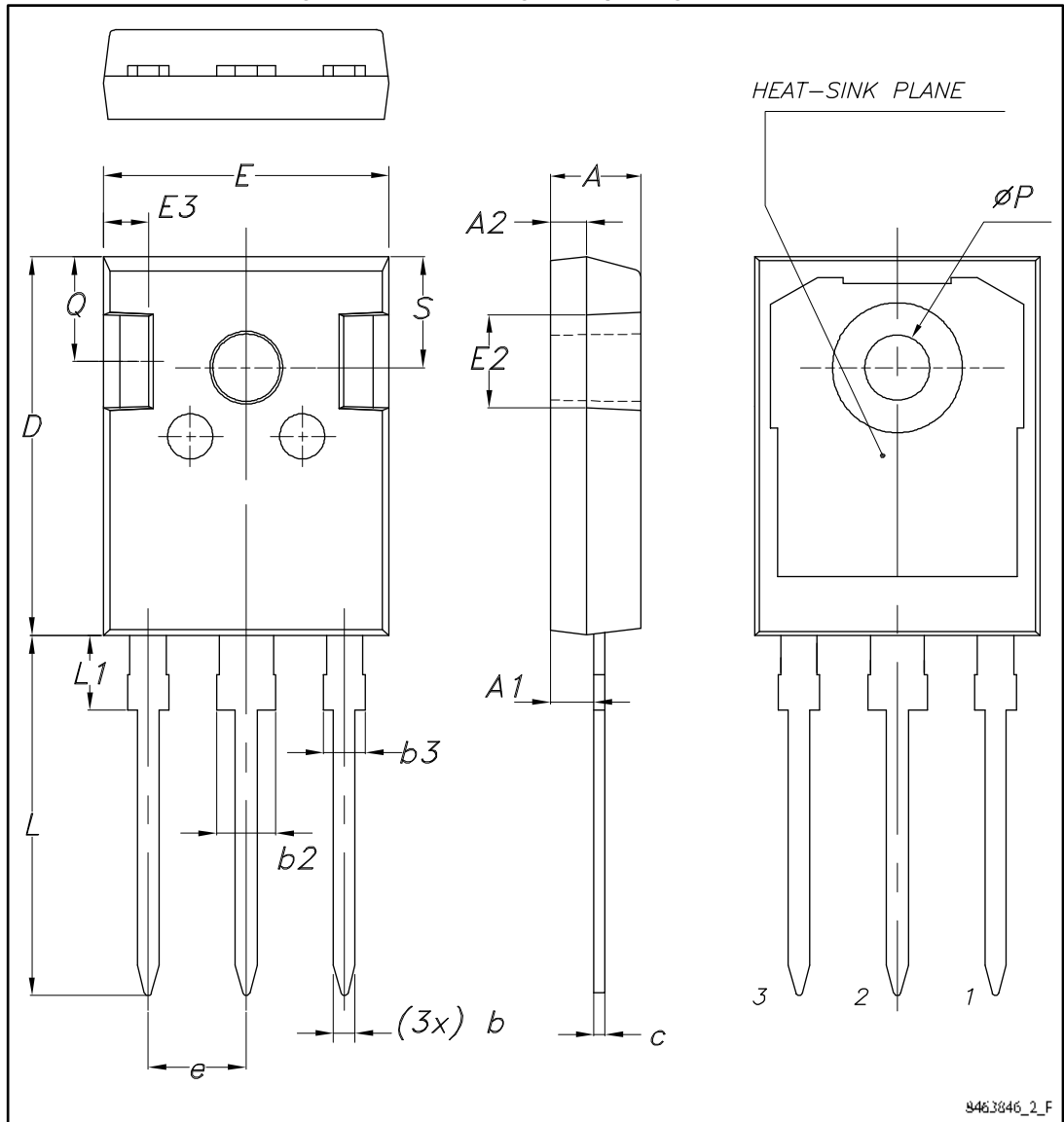

Table 9: TO-247 long leads package mechanical data

| Dim. | mm | | |
|------|-------|-------|-------|
| | Min. | Typ. | Max. |
| A | 4.90 | 5.00 | 5.10 |
| A1 | 2.31 | 2.41 | 2.51 |
| A2 | 1.90 | 2.00 | 2.10 |
| b | 1.16 | | 1.26 |
| b2 | | | 3.25 |
| b3 | | | 2.25 |
| c | 0.59 | | 0.66 |
| D | 20.90 | 21.00 | 21.10 |
| E | 15.70 | 15.80 | 15.90 |
| E2 | 4.90 | 5.00 | 5.10 |
| E3 | 2.40 | 2.50 | 2.60 |
| e | 5.34 | 5.44 | 5.54 |
| L | 19.80 | 19.92 | 20.10 |
| L1 | | | 4.30 |
| P | 3.50 | 3.60 | 3.70 |
| Q | 5.60 | | 6.00 |
| S | 6.05 | 6.15 | 6.25 |

5 Revision history

Table 10: Document revision history

| Date | Revision | Changes |
|-------------|----------|--|
| 02-Dec-2015 | 1 | First release. |
| 15-Jun-2016 | 2 | Inserted device in TO-247 and document updated accordingly. Inserted <i>Section 2.1: "Electrical characteristics (curves)"</i> . Document status promoted from preliminary to production data. Minor text changes. |
| 03-May-2017 | 3 | Modified: title, features and application on cover page. Modified <i>Table 4: "Static characteristics"</i> , <i>Table 7: "Diode switching characteristics (inductive load)"</i> and <i>Figure 13: "Normalized $V_{(BR)CES}$ vs. junction temperature"</i> . Minor text changes. |

IMPORTANT NOTICE – PLEASE READ CAREFULLY

STMicroelectronics NV and its subsidiaries ("ST") reserve the right to make changes, corrections, enhancements, modifications, and improvements to ST products and/or to this document at any time without notice. Purchasers should obtain the latest relevant information on ST products before placing orders. ST products are sold pursuant to ST's terms and conditions of sale in place at the time of order acknowledgement.

Purchasers are solely responsible for the choice, selection, and use of ST products and ST assumes no liability for application assistance or the design of Purchasers' products.

No license, express or implied, to any intellectual property right is granted by ST herein.

Resale of ST products with provisions different from the information set forth herein shall void any warranty granted by ST for such product.

ST and the ST logo are trademarks of ST. All other product or service names are the property of their respective owners.

Information in this document supersedes and replaces information previously supplied in any prior versions of this document.

© 2017 STMicroelectronics – All rights reserved