



# P-Channel JFETs

PRODUCT SUMMARY				
Part Number	V <sub>GS(off)</sub> (V)	r <sub>DS(on)</sub> Max (Ω)	I <sub>D(off)</sub> Typ (pA)	t <sub>ON</sub> Max (ns)
2N5114	5 to 10	75	-10	16
2N5115	3 to 6	100	-10	30
2N5116	1 to 4	150	-10	42

### FEATURES

- Low On-Resistance: 2N5114 <75 Ω
- Fast Switching—t<sub>ON</sub>: 16 ns
- High Off-Isolation—I<sub>D(off)</sub>: -10 pA
- Low Capacitance: 6 pF
- Low Insertion Loss

### BENEFITS

- Low Error Voltage
- High-Speed Analog Circuit Performance
- Negligible “Off-Error,” Excellent Accuracy
- Good Frequency Response
- Eliminates Additional Buffering

### APPLICATIONS

- Analog Switches
- Choppers
- Sample-and-Hold
- Normally “On” Switches
- Current Limiters

### DESCRIPTION

The 2N5114 series consists of p-channel JFET analog switches designed to provide low on-resistance, good off-isolation, and fast switching. These JFETs are optimized for use in complementary switching applications with the Vishay Siliconix 2N4856A series.

The 2N5114 series is available with JAN, JANTX, or JANTXV level processing, (see 2N5114 JAN series data sheet).

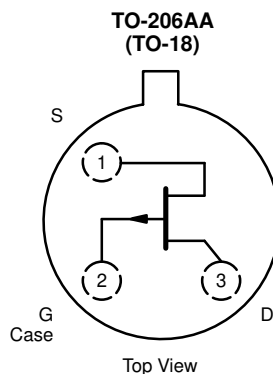

### ABSOLUTE MAXIMUM RATINGS

Gate-Drain Voltage ..... 30 V  
 Gate-Source Voltage ..... 30 V  
 Gate Current ..... -50 mA  
 Storage Temperature ..... -65 to 200°C  
 Operating Junction Temperature ..... -55 to 200°C

Lead Temperature (1/16" from case for 10 sec.) ..... 300°C  
 Power Dissipation<sup>a</sup> ..... 500 mW

Notes  
 a. Derate 3 mW/°C above 25°C

For applications information see AN104.



SPECIFICATIONS (T <sub>A</sub> = 25 °C UNLESS OTHERWISE NOTED)										
Parameter	Symbol	Test Conditions	Typ <sup>a</sup>	Limits						Unit
				2N5114		2N5115		2N5116		
				Min	Max	Min	Max	Min	Max	
<b>Static</b>										
Gate-Source Breakdown Voltage	V <sub>(BR)GSS</sub>	I <sub>G</sub> = 1 μA, V <sub>DS</sub> = 0 V	45	30		30		30		V
Gate-Source Cutoff Voltage	V <sub>GS(off)</sub>	V <sub>DS</sub> = -15 V, I <sub>D</sub> = -1 nA		5	10	3	6	1	4	
Saturation Drain Current <sup>b</sup>	I <sub>DSS</sub>	V <sub>GS</sub> = 0 V	V <sub>DS</sub> = -18 V	-30	-90					mA
			V <sub>DS</sub> = -15 V			-15	-60	-5	-25	
Gate Reverse Current	I <sub>GSS</sub>	V <sub>GS</sub> = 20 V, V <sub>DS</sub> = 0 V	T <sub>A</sub> = 25 °C	5	500		500		500	pA
			T <sub>A</sub> = 150 °C	0.01	1		1		1	μA
Gate Operating Current <sup>c</sup>	I <sub>G</sub>	V <sub>DG</sub> = -15 V, I <sub>D</sub> = -1 mA	-5							
Drain Cutoff Current	I <sub>D(off)</sub>	V <sub>DS</sub> = -15 V	V <sub>GS</sub> = 12 V	-10	-500					pA
			V <sub>GS</sub> = 7 V	-10			-500			
			V <sub>GS</sub> = 5 V	-10				-500		
		V <sub>DS</sub> = -15 V T <sub>A</sub> = 150 °C	V <sub>GS</sub> = 12 V	-0.02	-1					μA
			V <sub>GS</sub> = 7 V	-0.02			-1			
			V <sub>GS</sub> = 5 V	-0.02				-1		
Drain-Source On-Voltage	V <sub>DS(on)</sub>	V <sub>GS</sub> = 0 V	I <sub>D</sub> = -15 mA	-1.0	-1.3					V
			I <sub>D</sub> = -7 mA	-0.7			-0.8			
			I <sub>D</sub> = -3 mA	-0.5				-0.6		
Drain-Source On-Resistance	r <sub>DS(on)</sub>	V <sub>GS</sub> = 0 V, I <sub>D</sub> = -1 mA			75		100		150	Ω
Gate-Source Forward Voltage	V <sub>GS(F)</sub>	I <sub>G</sub> = -1 mA, V <sub>DS</sub> = 0 V	-0.7	-1		-1			-1	V
<b>Dynamic</b>										
Common-Source Forward Transconductance <sup>c</sup>	g <sub>fs</sub>	V <sub>DS</sub> = -15 V, I <sub>D</sub> = -1 mA f = 1 kHz	4.5							mS
Common-Source Output Conductance <sup>c</sup>	g <sub>os</sub>		20							μS
Drain-Source On-Resistance	r <sub>ds(on)</sub>	V <sub>GS</sub> = 0 V, I <sub>D</sub> = 0 mA, f = 1 kHz			75		100		150	Ω
Common-Source Input Capacitance	C <sub>iss</sub>	V <sub>DS</sub> = -15 V, V <sub>GS</sub> = 0 V f = 1 MHz	20		25		25		25	pF
Common-Source Reverse Transfer Capacitance	C <sub>rss</sub>	V <sub>DS</sub> = 0 V f = 1 MHz	V <sub>GS</sub> = 12 V	5	7					
			V <sub>GS</sub> = 7 V	6			7			
			V <sub>GS</sub> = 5 V	6				7		
Equivalent Input Noise Voltage <sup>c</sup>	e <sub>n</sub>	V <sub>DS</sub> = 10 V, I <sub>D</sub> = 10 mA f = 1 kHz	20							nV/ √Hz
<b>Switching</b>										
Turn-On Time	t <sub>d(on)</sub>	See Switching Circuit			6		10		12	ns
	t <sub>r</sub>				10		20		30	
Turn-Off Time	t <sub>d(off)</sub>				6		8		10	
	t <sub>f</sub>				15		30		50	

Notes

- a. Typical values are for DESIGN AID ONLY, not guaranteed nor subject to production testing.
- b. Pulse test: PW ≤ 300 μs duty cycle ≤ 3%.
- c. This parameter not registered with JEDEC.

PSCIA



**TYPICAL CHARACTERISTICS (T<sub>A</sub> = 25°C UNLESS OTHERWISE NOTED)**

**On-Resistance and Drain Current vs. Gate-Source Cutoff Voltage**

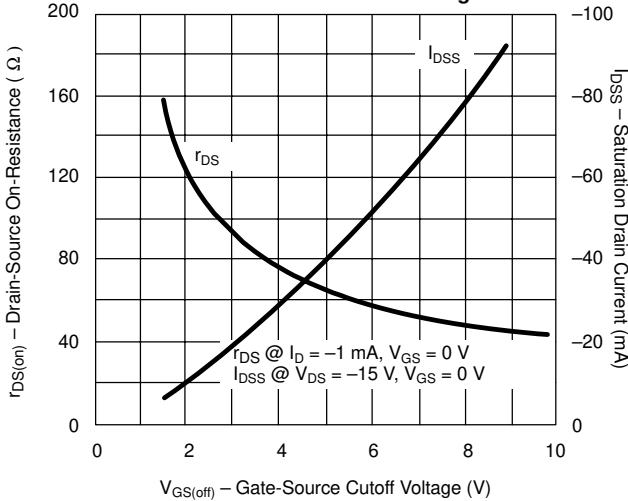

**Forward Transconductance and Output Conductance vs. Gate-Source Cutoff Voltage**

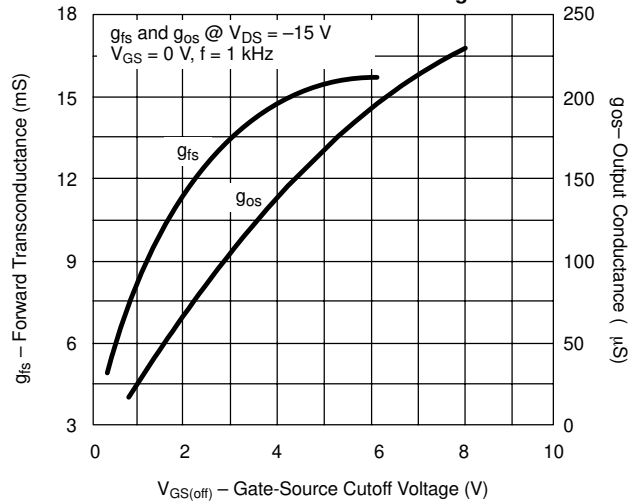

**On-Resistance vs. Drain Current**

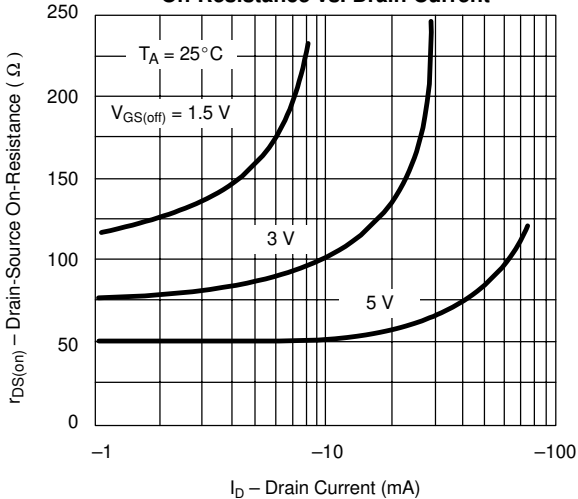

**On-Resistance vs. Temperature**

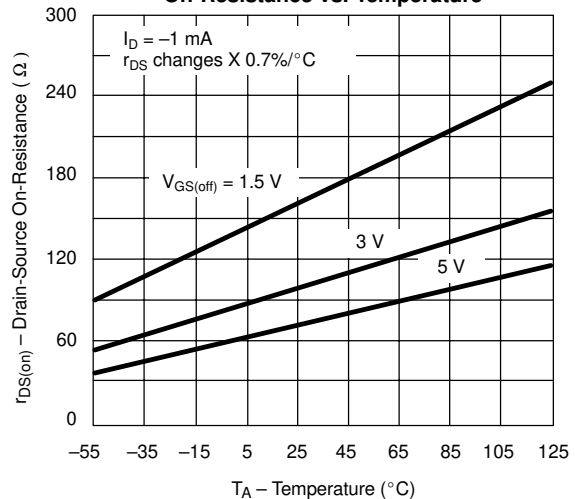

**Turn-On Switching**

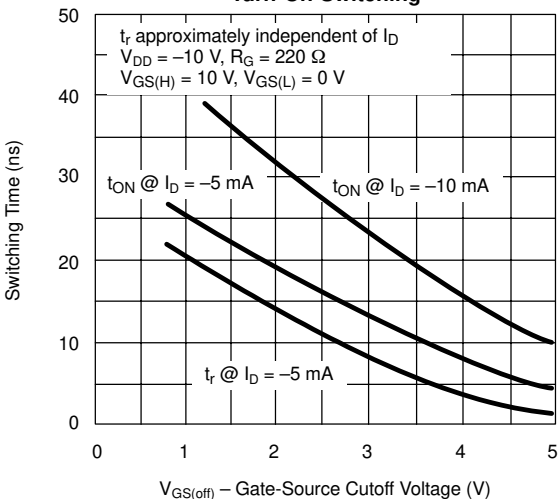

**Turn-Off Switching**

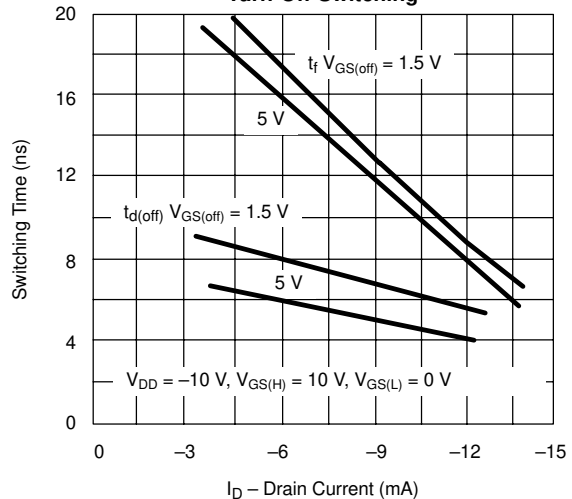

**TYPICAL CHARACTERISTICS ( $T_A = 25^\circ\text{C}$  UNLESS OTHERWISE NOTED)**

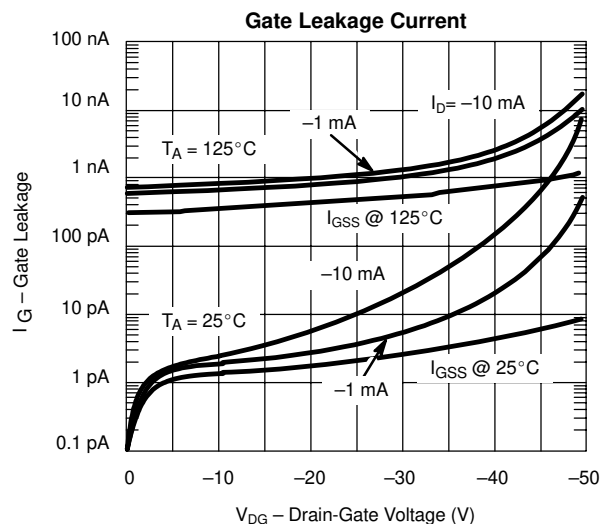
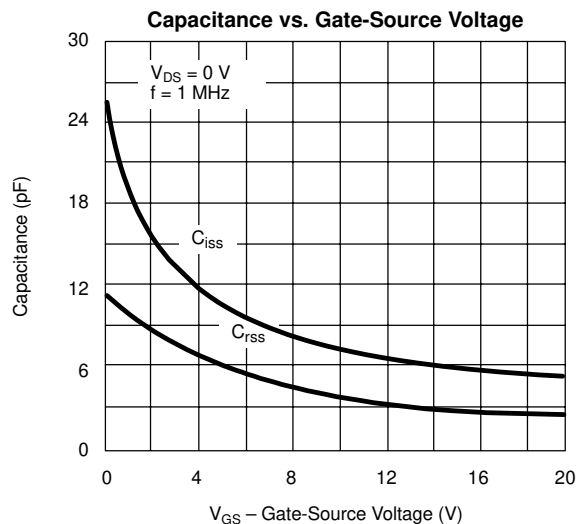
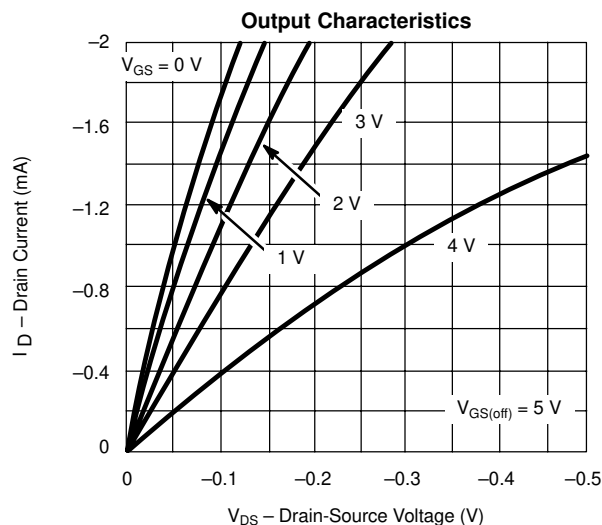
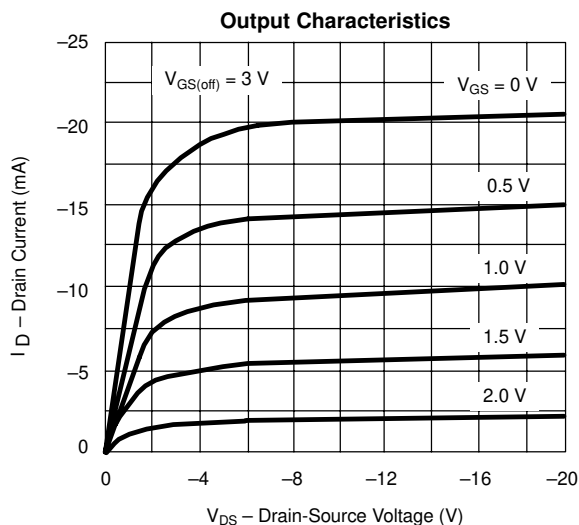
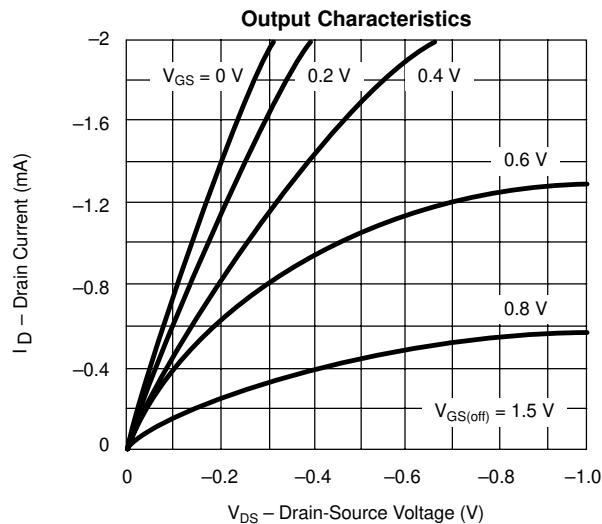
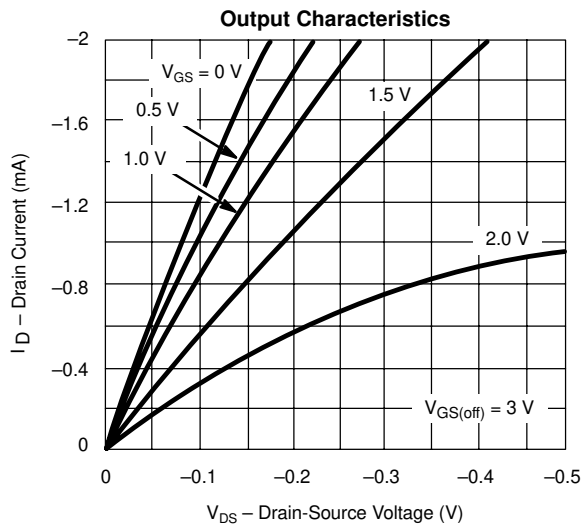



**TYPICAL CHARACTERISTICS (T<sub>A</sub> = 25°C UNLESS OTHERWISE NOTED)**

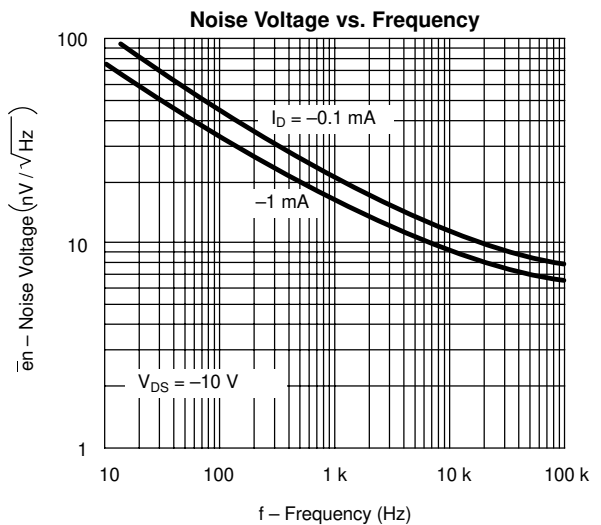
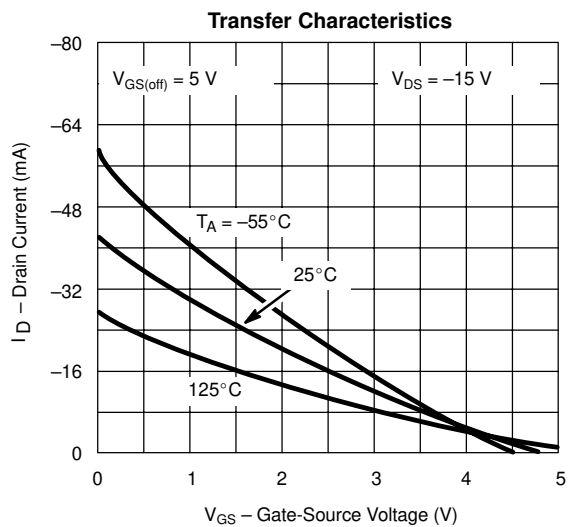
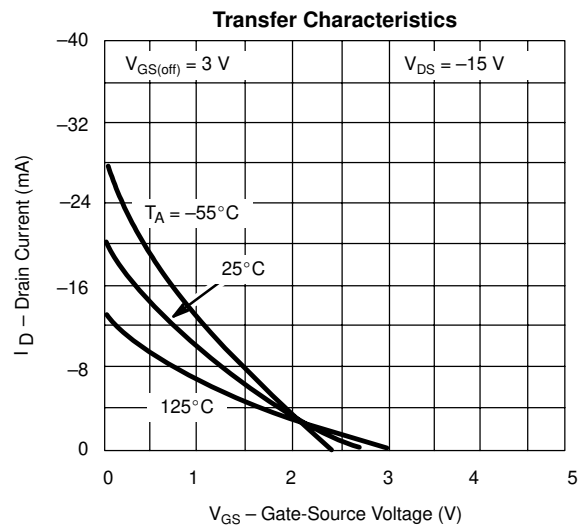
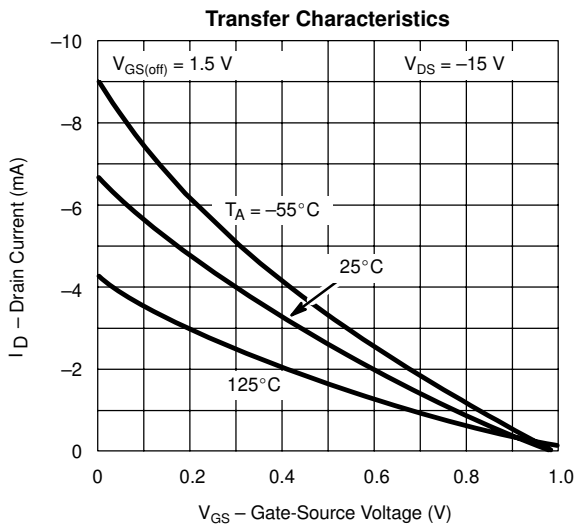

<b>SWITCHING TIME TEST CIRCUIT</b>			
	2N5114	2N5115	2N5116
V <sub>DD</sub>	-10 V	-6 V	-6 V
V <sub>GG</sub>	20 V	12 V	8 V
R <sub>L</sub> *	430 Ω	910 Ω	2 kΩ
R <sub>G</sub> *	100 Ω	220 Ω	390 Ω
I <sub>D(on)</sub>	-15 mA	-7 mA	-3 mA
V <sub>GS(H)</sub>	0 V	0 V	0 V
V <sub>GS(L)</sub>	-11 V	-7 V	-5 V

\*Non-inductive

**INPUT PULSE**

Rise Time < 1 ns  
 Fall Time < 1 ns  
 Pulse Width 100 ns  
 PRF 1 MHz

**SAMPLING SCOPE**

Rise Time 0.4 ns  
 Input Resistance 10 MΩ  
 Input Capacitance 1.5 pF

See Typical Characteristics curves for changes.

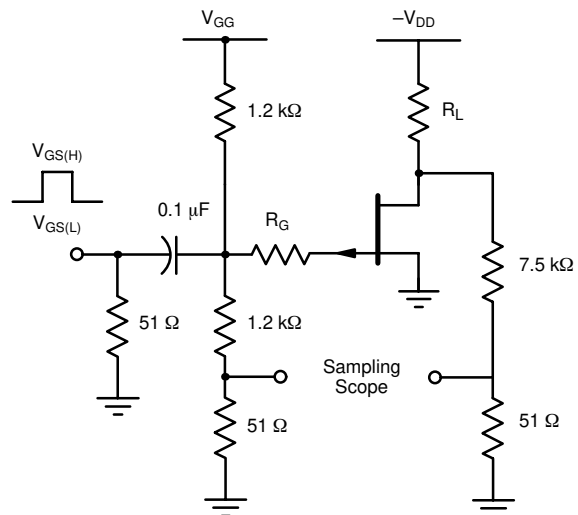



## Notice

Specifications of the products displayed herein are subject to change without notice. Vishay Intertechnology, Inc., or anyone on its behalf, assumes no responsibility or liability for any errors or inaccuracies.

Information contained herein is intended to provide a product description only. No license, express or implied, by estoppel or otherwise, to any intellectual property rights is granted by this document. Except as provided in Vishay's terms and conditions of sale for such products, Vishay assumes no liability whatsoever, and disclaims any express or implied warranty, relating to sale and/or use of Vishay products including liability or warranties relating to fitness for a particular purpose, merchantability, or infringement of any patent, copyright, or other intellectual property right.

The products shown herein are not designed for use in medical, life-saving, or life-sustaining applications. Customers using or selling these products for use in such applications do so at their own risk and agree to fully indemnify Vishay for any damages resulting from such improper use or sale.