

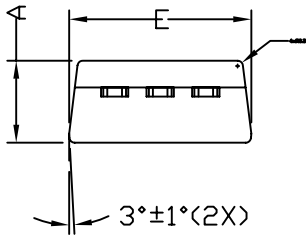

TO262 PACKAGE OUTLINE

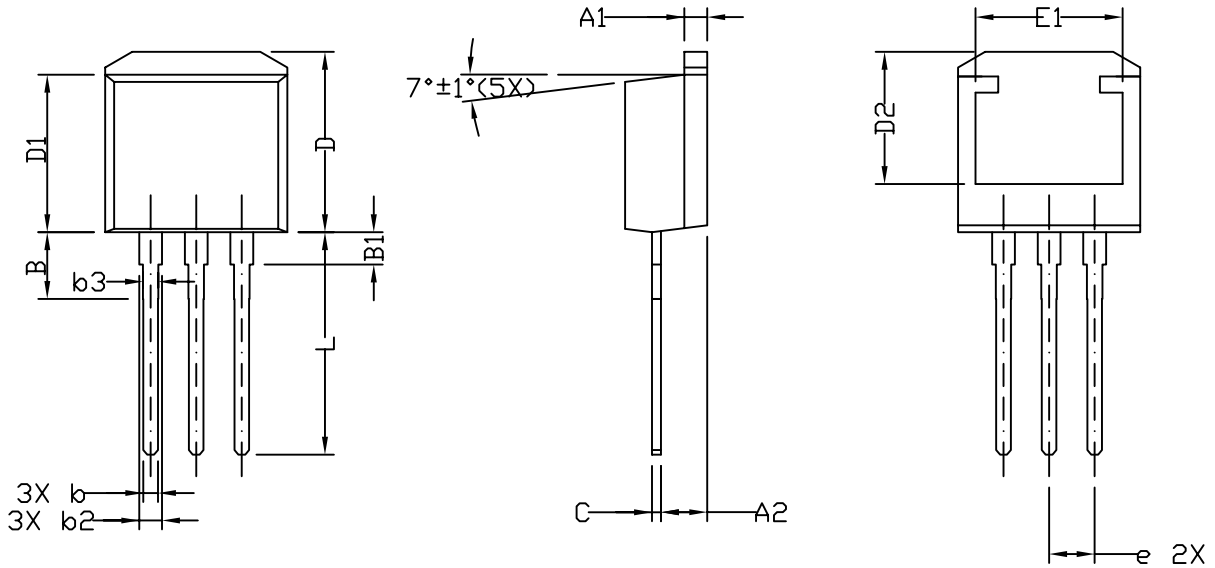

SYMBOL	DIMENSIONAL REQMTS			INCHES REQMTS		
	MIN	NOM	MAX	MIN	NOM	MAX
A	4.30	4.57	4.72	0.169	0.180	0.186
A1	1.17	1.27	1.37	0.046	0.050	0.054
A2	2.47	2.57	2.67	0.097	0.101	0.105
B	3.55	3.72	3.90	0.140	0.146	0.154
B1	1.65	1.80	2.00	0.065	0.071	0.079
b	0.69	0.813	0.94	0.027	0.032	0.037
b2	1.17	1.27	1.45	0.046	0.050	0.057
b3	0.74	0.86	0.91	0.029	0.034	0.036
c	0.48	0.50	0.60	0.019	0.020	0.024
D	9.80	10.05	10.30	0.386	0.396	0.406
D1	8.64	8.78	9.65	0.340	0.346	0.380
D2	7.12	7.37	7.62	0.280	0.290	0.300
e	2.54 BSC			0.100 BSC		
E	9.70	10.15	10.54	0.382	0.400	0.415
E1	8.00	8.20	8.40	0.315	0.323	0.331
L	12.27	12.40	13.48	0.483	0.488	0.531

RECOMMENDED LAND PATTERN

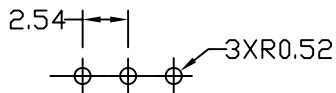

NOTE

1. CONTROLLING DIMENSION IS MILLIMETER.
CONVERTED INCH DIMENSIONS ARE NOT NECESSARILY EXACT.