

**DMN3730UFB**

**30V N-CHANNEL ENHANCEMENT MODE MOSFET**

**Product Summary**

$V_{(BR)DSS}$	$R_{DS(on)}$	$I_D$ $T_A = +25^\circ C$
30V	460m $\Omega$ @ $V_{GS} = 4.5V$	0.9A
	560m $\Omega$ @ $V_{GS} = 2.5V$	0.7A

**Description and Applications**

This MOSFET is designed to minimize the on-state resistance ( $R_{DS(on)}$ ) and yet maintain superior switching performance, making it ideal for high efficiency power management applications.

- Load Switch
- Portable Applications
- Power Management Functions

**Features and Benefits**

- 0.5mm ultra low profile package for thin application
- 0.6mm<sup>2</sup> package footprint, 10 times smaller than SOT23
- Low  $V_{GS(th)}$ , can be driven directly from a battery
- Low  $R_{DS(on)}$
- **Totally Lead-Free & Fully RoHS Compliant (Notes 1 & 2)**
- **Halogen and Antimony Free. "Green" Device (Note 3)**
- **ESD Protected Gate 2kV**
- **Qualified to AEC-Q101 Standards for High Reliability**

**Mechanical Data**

- Case: X1-DFN1006-3
- Case Material: Molded Plastic, "Green" Molding Compound; UL Flammability Classification Rating 94V-0
- Moisture Sensitivity: Level 1 per J-STD-020
- Terminal Connections: See Diagram
- Terminals: Finish – NiPdAu over Copper Leadframe; Solderable per MIL-STD-202, Method 208(e4)
- Weight: 0.001 grams (Approximate)



X1-DFN1006-3

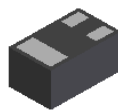

Bottom View

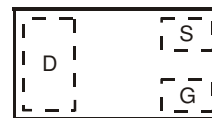

Top View  
Internal Schematic

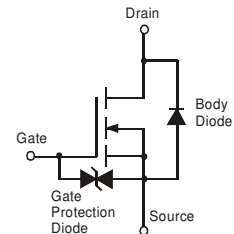



Equivalent Circuit

**Ordering Information** (Note 4)

Part Number	Marking	Reel size (inches)	Tape width (mm)	Quantity per reel
DMN3730UFB-7	NE	7	8	3,000
DMN3730UFB-7B	NE	7	8	10,000

- Notes:
1. No purposely added lead. Fully EU Directive 2002/95/EC (RoHS) & 2011/65/EU (RoHS 2) compliant.
  2. See [http://www.diodes.com/quality/lead\\_free.html](http://www.diodes.com/quality/lead_free.html) for more information about Diodes Incorporated's definitions of Halogen- and Antimony-free, "Green" and Lead-free.
  3. Halogen- and Antimony-free "Green" products are defined as those which contain <900ppm bromine, <900ppm chlorine (<1500ppm total Br + Cl) and <1000ppm antimony compounds.
  4. For packaging details, go to our website at <http://www.diodes.com/products/packages.html>.

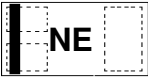
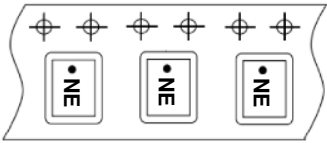
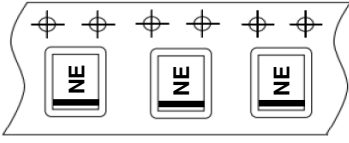
**Marking Information**

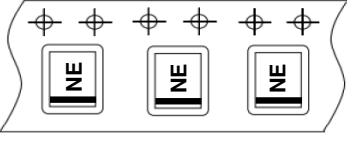
<p><b>DMN3730UFB-7</b></p>	<div style="display: flex; justify-content: space-around;"> <div style="text-align: center;">  <p>Top View Dot Denotes Drain Side</p> </div> <div style="text-align: center;"> <p>From date code 1527 (YYWW), this changes to:</p>  <p>Top View Bar Denotes Gate and Source Side</p> </div> </div> <div style="display: flex; justify-content: space-around; margin-top: 20px;">   </div>
<p><b>DMN3730UFB-7B</b></p>	<div style="text-align: center;">  <p>Top View Bar Denotes Gate and Source Side</p> </div> <div style="text-align: center; margin-top: 20px;">  </div> <div style="text-align: right; margin-top: 20px;"> <p>NE = Part Marking Code</p> </div>

**Maximum Ratings** (@T<sub>A</sub> = +25°C unless otherwise specified.)

Characteristic		Symbol	Value	Unit
Drain-Source Voltage		V <sub>DSS</sub>	30	V
Gate-Source Voltage		V <sub>GSS</sub>	±8	
Continuous Drain Current	V <sub>GS</sub> = 4.5V	(Note 6)	0.91	A
		T <sub>A</sub> = +70°C (Note 6)	0.73	
		(Note 5)	0.75	
Pulsed Drain Current		I <sub>DM</sub>	3	A

**Thermal Characteristics** (@T<sub>A</sub> = +25°C unless otherwise specified.)

Characteristic		Symbol	Value	Unit
Power Dissipation	(Note 6)	P <sub>D</sub>	0.69	W
	(Note 5)		0.47	
Thermal Resistance, Junction to Ambient	(Note 6)	R <sub>θJA</sub>	180	°C/W
	(Note 5)		258	
Operating and Storage Temperature Range		T <sub>J</sub> , T <sub>STG</sub>	-55 to +150	°C

**Electrical Characteristics** (@T<sub>A</sub> = +25°C unless otherwise specified.)

Characteristic	Symbol	Min	Typ	Max	Unit	Test Condition
<b>OFF CHARACTERISTICS</b>						
Drain-Source Breakdown Voltage	BV <sub>DSS</sub>	30	-	-	V	V <sub>GS</sub> = 0V, I <sub>D</sub> = 10μA
Zero Gate Voltage Drain Current T <sub>J</sub> = +25°C	I <sub>DSS</sub>	-	-	1	μA	V <sub>DS</sub> = 30V, V <sub>GS</sub> = 0V
Gate-Source Leakage	I <sub>GSS</sub>	-	-	3	μA	V <sub>GS</sub> = ±8V, V <sub>DS</sub> = 0V
<b>ON CHARACTERISTICS</b>						
Gate Threshold Voltage	V <sub>GS(th)</sub>	0.45	-	0.95	V	V <sub>DS</sub> = V <sub>GS</sub> , I <sub>D</sub> = 250μA
Static Drain-Source On-Resistance (Note 8)	R <sub>DS(on)</sub>	-	-	460	mΩ	V <sub>GS</sub> = 4.5V, I <sub>D</sub> = 200mA
				560		V <sub>GS</sub> = 2.5V, I <sub>D</sub> = 100mA
				730		V <sub>GS</sub> = 1.8V, I <sub>D</sub> = 75mA
Forward Transfer Admittance	Y <sub>fs</sub>	40	-	-	mS	V <sub>DS</sub> = 3V, I <sub>D</sub> = 10mA
Diode Forward Voltage (Note 8)	V <sub>SD</sub>	-	0.7	1.2	V	V <sub>GS</sub> = 0V, I <sub>S</sub> = 300mA
<b>DYNAMIC CHARACTERISTICS (Note 9)</b>						
Input Capacitance	C <sub>iss</sub>	-	64.3	-	pF	V <sub>DS</sub> = 25V, V <sub>GS</sub> = 0V, f = 1.0MHz
Output Capacitance	C <sub>oss</sub>	-	6.1	-	pF	
Reverse Transfer Capacitance	C <sub>rss</sub>	-	4.5	-	pF	
Gate Resistance	R <sub>g</sub>	-	70	-	Ω	V <sub>DS</sub> = 0V, V <sub>GS</sub> = 0V, f = 1MHz
Total Gate Charge	Q <sub>g</sub>	-	1.6	-	nC	V <sub>GS</sub> = 4.5V, V <sub>DS</sub> = 15V, I <sub>D</sub> = 1A
Gate-Source Charge	Q <sub>gs</sub>	-	0.2	-	nC	
Gate-Drain Charge	Q <sub>gd</sub>	-	0.2	-	nC	
Turn-On Delay Time	t <sub>D(on)</sub>	-	3.5	-	ns	V <sub>DS</sub> = 10V, I <sub>D</sub> = 1A V <sub>GS</sub> = 10V, R <sub>G</sub> = 6Ω
Turn-On Rise Time	t <sub>r</sub>	-	2.8	-	ns	
Turn-Off Delay Time	t <sub>D(off)</sub>	-	38	-	ns	
Turn-Off Fall Time	t <sub>f</sub>	-	13	-	ns	

- Notes:
5. For a device surface mounted on a minimum recommended pad layout of an FR4 PCB, in still air conditions; the device is measured when operating in steady-state condition.
  6. Same as Note 5, except the device measured at t ≤ 10 seconds.
  7. Same as Note 5, except the device is pulsed at duty cycle of 1% for a pulse width of 10μs.
  8. Measured under pulsed conditions to minimize self-heating effect. Pulse width ≤ 300μs; duty cycle ≤ 2%.
  9. For design aid only, not subject to production testing.

**DMN3730UFB**

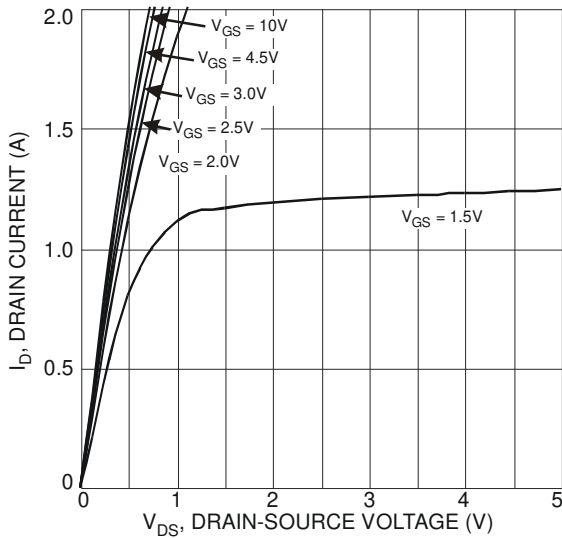

Fig. 1 Typical Output Characteristic

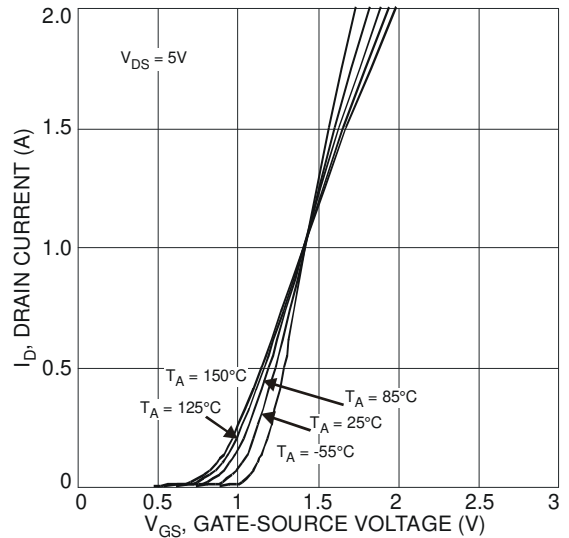

Fig. 2 Typical Transfer Characteristic

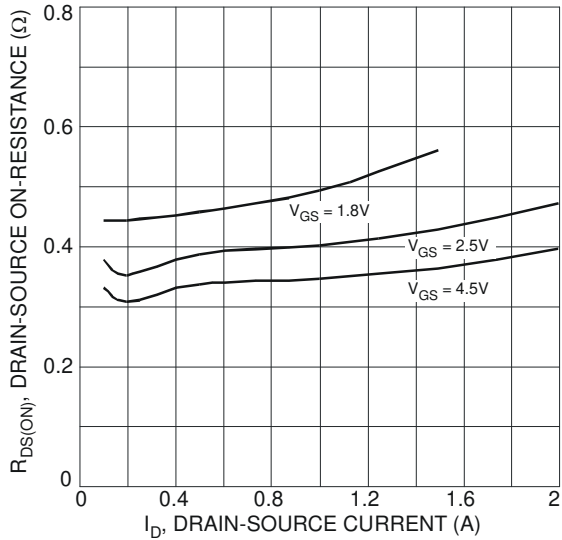

Fig. 3 Typical On-Resistance vs. Drain Current and Gate Voltage

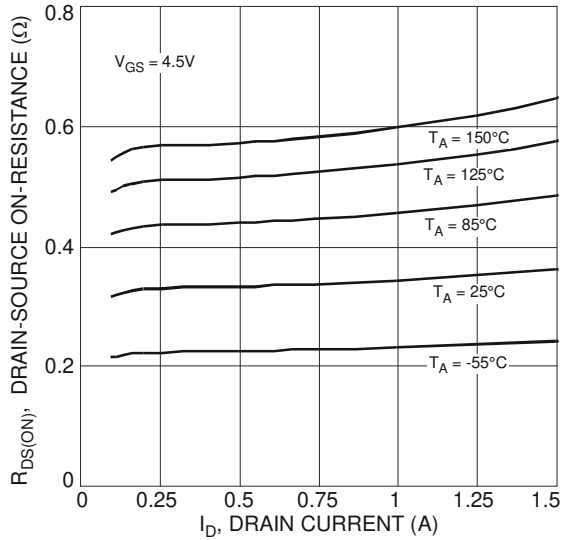

Fig. 4 Typical On-Resistance vs. Drain Current and Temperature

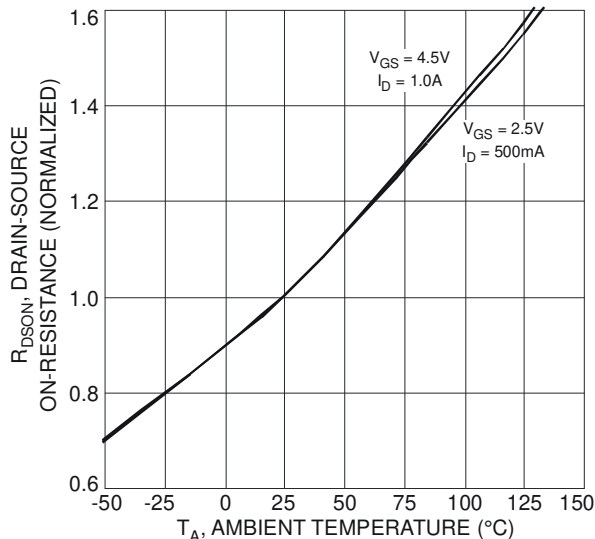

Fig. 5 On-Resistance Variation with Temperature

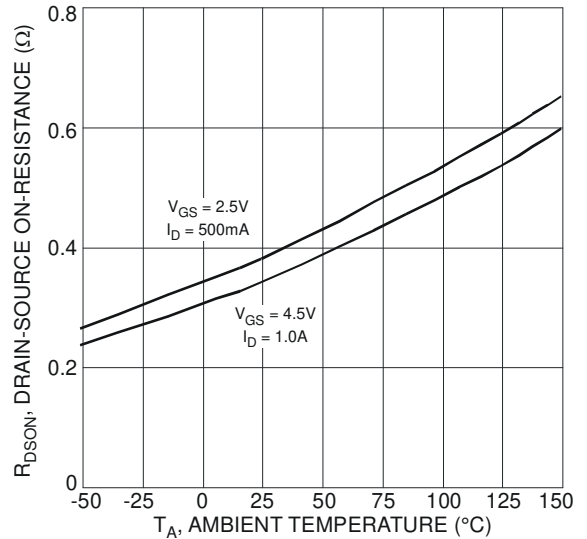

Fig. 6 On-Resistance Variation with Temperature

**DMN3730UFB**

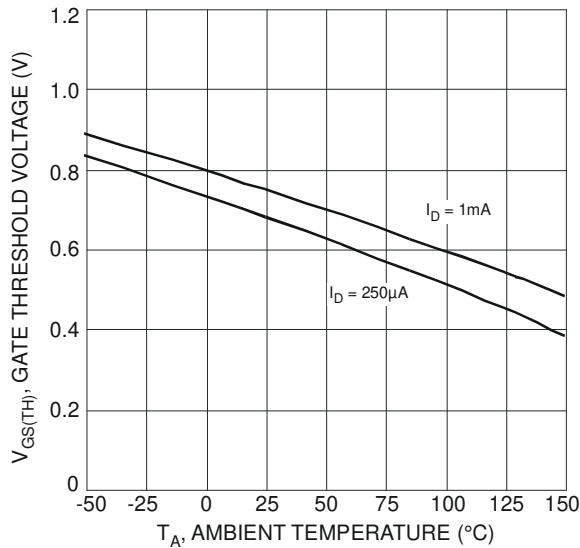

Fig. 7 Gate Threshold Variation vs. Ambient Temperature

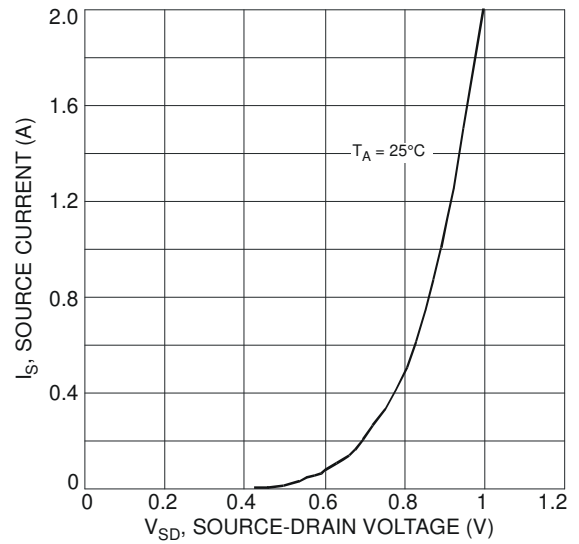

Fig. 8 Diode Forward Voltage vs. Current

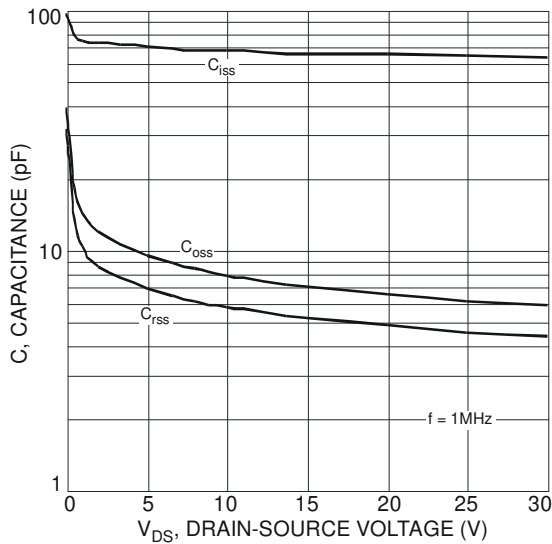

Fig. 9 Typical Total Capacitance

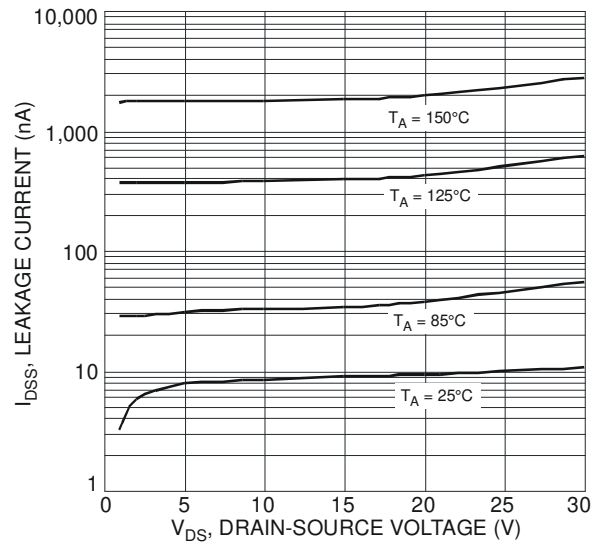

Fig. 10 Typical Leakage Current vs. Drain-Source Voltage

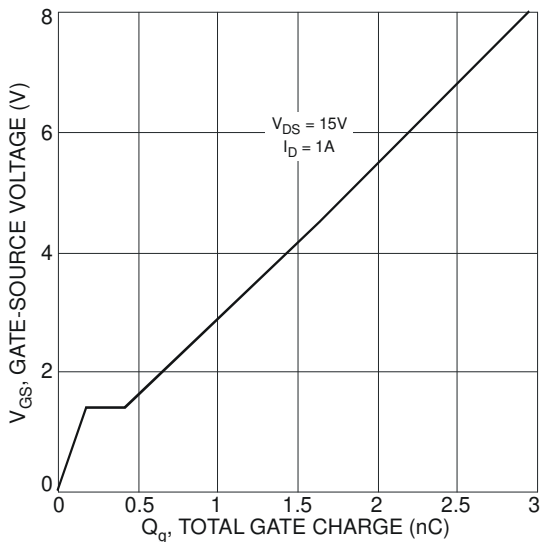

Fig. 11 Gate-Charge Characteristics

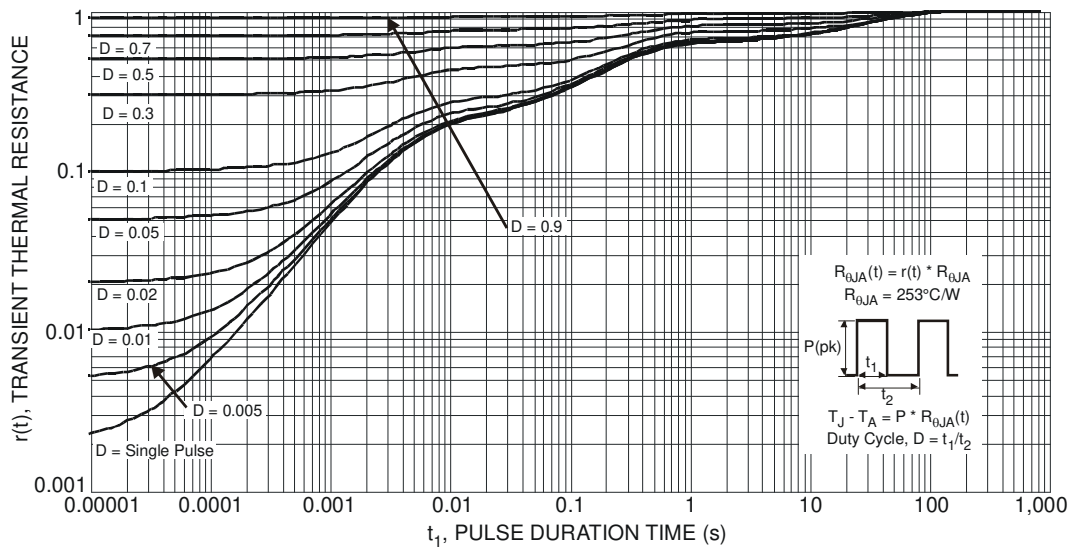
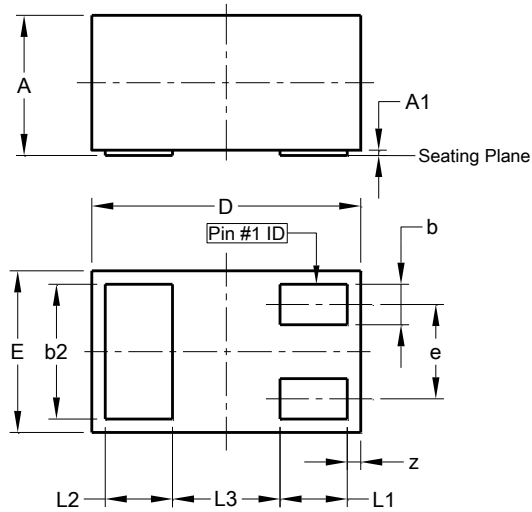

Fig. 12 Transient Thermal Response

## Package Outline Dimensions

Please see AP02002 at <http://www.diodes.com/datasheets/ap02002.pdf> for the latest version.



X1-DFN1006-3			
Dim	Min	Max	Typ
A	0.47	0.53	0.50
A1	0.00	0.05	0.03
b	0.10	0.20	0.15
b2	0.45	0.55	0.50
D	0.95	1.075	1.00
E	0.55	0.675	0.60
e	-	-	0.35
L1	0.20	0.30	0.25
L2	0.20	0.30	0.25
L3	-	-	0.40
z	0.02	0.08	0.05
All Dimensions in mm			

## Suggested Pad Layout

Please see AP02001 at <http://www.diodes.com/datasheets/ap02001.pdf> for the latest version.

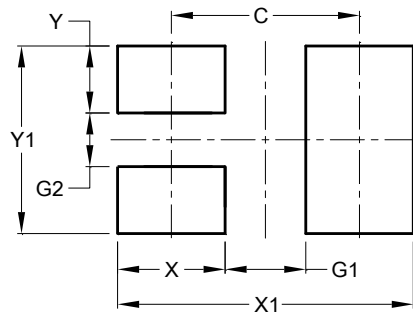

Dimensions	Value (in mm)
C	0.70
G1	0.30
G2	0.20
X	0.40
X1	1.10
Y	0.25
Y1	0.70

**IMPORTANT NOTICE**

DIODES INCORPORATED MAKES NO WARRANTY OF ANY KIND, EXPRESS OR IMPLIED, WITH REGARDS TO THIS DOCUMENT, INCLUDING, BUT NOT LIMITED TO, THE IMPLIED WARRANTIES OF MERCHANTABILITY AND FITNESS FOR A PARTICULAR PURPOSE (AND THEIR EQUIVALENTS UNDER THE LAWS OF ANY JURISDICTION).

Diodes Incorporated and its subsidiaries reserve the right to make modifications, enhancements, improvements, corrections or other changes without further notice to this document and any product described herein. Diodes Incorporated does not assume any liability arising out of the application or use of this document or any product described herein; neither does Diodes Incorporated convey any license under its patent or trademark rights, nor the rights of others. Any Customer or user of this document or products described herein in such applications shall assume all risks of such use and will agree to hold Diodes Incorporated and all the companies whose products are represented on Diodes Incorporated website, harmless against all damages.

Diodes Incorporated does not warrant or accept any liability whatsoever in respect of any products purchased through unauthorized sales channel. Should Customers purchase or use Diodes Incorporated products for any unintended or unauthorized application, Customers shall indemnify and hold Diodes Incorporated and its representatives harmless against all claims, damages, expenses, and attorney fees arising out of, directly or indirectly, any claim of personal injury or death associated with such unintended or unauthorized application.

Products described herein may be covered by one or more United States, international or foreign patents pending. Product names and markings noted herein may also be covered by one or more United States, international or foreign trademarks.

This document is written in English but may be translated into multiple languages for reference. Only the English version of this document is the final and determinative format released by Diodes Incorporated.

**LIFE SUPPORT**

Diodes Incorporated products are specifically not authorized for use as critical components in life support devices or systems without the express written approval of the Chief Executive Officer of Diodes Incorporated. As used herein:

A. Life support devices or systems are devices or systems which:

1. are intended to implant into the body, or
2. support or sustain life and whose failure to perform when properly used in accordance with instructions for use provided in the labeling can be reasonably expected to result in significant injury to the user.

B. A critical component is any component in a life support device or system whose failure to perform can be reasonably expected to cause the failure of the life support device or to affect its safety or effectiveness.

Customers represent that they have all necessary expertise in the safety and regulatory ramifications of their life support devices or systems, and acknowledge and agree that they are solely responsible for all legal, regulatory and safety-related requirements concerning their products and any use of Diodes Incorporated products in such safety-critical, life support devices or systems, notwithstanding any devices- or systems-related information or support that may be provided by Diodes Incorporated. Further, Customers must fully indemnify Diodes Incorporated and its representatives against any damages arising out of the use of Diodes Incorporated products in such safety-critical, life support devices or systems.

Copyright © 2015, Diodes Incorporated

[www.diodes.com](http://www.diodes.com)