

## Product Summary

$V_{(BR)DSS}$	$R_{DS(on) \max}$	$I_D$ $T_A = +25^\circ\text{C}$
70V	0.13Ω @ $V_{GS} = 10\text{V}$	3.8A

## Description

This new generation of trench MOSFETs from Zetex utilizes a unique structure that combines the benefits of low on-resistance with fast switching speed. This makes them ideal for high efficiency, low voltage power management applications.

## Applications

- DC-DC Converters
- Power Management Functions
- Disconnect Switches
- Motor Control
- Class D Audio Output Stages



Top View

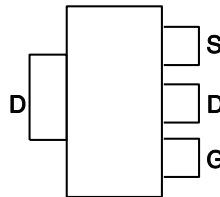

Pin Out - Top View

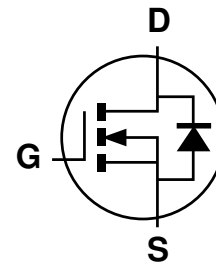

Equivalent Circuit

## Features and Benefits

- Low On-Resistance
- Fast Switching Speed
- Low Threshold
- Low Gate Drive
- **Lead-Free Finish; RoHS Compliant (Notes 1 & 2)**
- **Halogen and Antimony Free. "Green" Device (Note 3)**
- **Qualified to AEC-Q101 Standards for High Reliability**

## Mechanical Data

- Case: SOT223
- Case Material: Molded Plastic, "Green" Molding Compound; UL Flammability Classification Rating 94V-0
- Moisture Sensitivity: Level 1 per J-STD-020
- Terminals Connections: See Diagram Below
- Terminals: Finish - Matte Tin Annealed over Copper Leadframe; Solderable per MIL-STD-202, Method 208 (Ⓔ3)
- Weight: 0.112 grams (Approximate)

## Ordering Information (Note 4)

Part Number	Qualification	Case	Packaging
ZXMN7A11GTA	Standard	SOT223	1,000 / Tape & Reel
ZXMN7A11GTC	Standard	SOT223	4,000 / Tape & Reel

- Notes:
1. EU Directive 2002/95/EC (RoHS) & 2011/65/EU (RoHS 2) compliant. All applicable RoHS exemptions applied.
  2. See [http://www.diodes.com/quality/lead\\_free.html](http://www.diodes.com/quality/lead_free.html) for more information about Diodes Incorporated's definitions of Halogen- and Antimony-free, "Green" and Lead-free.
  3. Halogen- and Antimony-free "Green" products are defined as those which contain <900ppm bromine, <900ppm chlorine (<1500ppm total Br + Cl) and <1000ppm antimony compounds.
  4. For packaging details, go to our website at <http://www.diodes.com/products/packages.html>.

## Marking Information

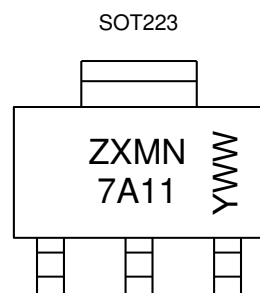

ZXMN 7A11 = Product Type Marking Code  
 YWW = Date Code Marking  
 Y or  $\bar{Y}$  = Last Digit of Year (ex: 5= 2015)  
 WW or  $\bar{W}W$  = Week Code (01~53)

**Maximum Ratings** (@ $T_A = +25^\circ\text{C}$ , unless otherwise specified.)

Characteristic	Symbol	Value	Units
Drain-Source Voltage	$V_{DSS}$	70	V
Gate-Source Voltage	$V_G$	$\pm 20$	V
Continuous Drain Current, $V_{GS} = 10\text{V}$ ,	$I_D$	$T_A = +25^\circ\text{C}$ (Note 6)	3.8
		$T_A = +70^\circ\text{C}$ (Note 6)	3.0
		$T_A = +25^\circ\text{C}$ (Note 5)	2.7
Maximum Continuous Body Diode Forward Current (Note 6)	$I_S$	5	A
Pulsed Drain Current	$I_{DM}$	10	A
Pulsed Source Current (Body Diode)	$I_{SM}$	10	A

**Thermal Resistance** (@ $T_A = +25^\circ\text{C}$ , unless otherwise specified.)

Characteristic	Symbol	Value	Units
Total Power Dissipation at $T_A = +25^\circ\text{C}$ (Note 5)	$P_D$	2.0	W
Linear Derating Factor (Note 5)		16	mW/ $^\circ\text{C}$
Total Power Dissipation at $T_A = +25^\circ\text{C}$ (Note 6)	$P_D$	3.9	W
Linear Derating Factor (Note 6)		31	mW/ $^\circ\text{C}$
Thermal Resistance, Junction to Ambient (Note 5)	$R_{\theta JA}$	62.5	$^\circ\text{C}/\text{W}$
Thermal Resistance, Junction to Ambient (Note 6)	$R_{\theta JA}$	32	$^\circ\text{C}/\text{W}$
Operating and Storage Temperature Range	$T_J, T_{STG}$	-55 to +150	$^\circ\text{C}$

- Notes:
5. For a device surface mounted on 25mm x 25mm FR4 PCB with high coverage of single sided 1oz copper, in still air conditions.
  6. For a device surface mounted on FR4 PCB measured at  $t \leq 5$  sec.
  7. Repetitive rating 25mm x 25mm FR4 PCB,  $D=0.05$  pulse width= $10\mu\text{s}$  - pulse width limited by maximum junction temperature.

**Thermal Characteristics** (@ $T_A = +25^\circ\text{C}$ , unless otherwise specified.)

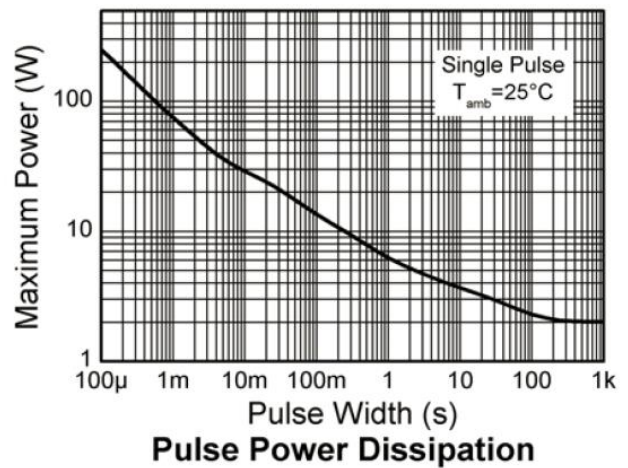
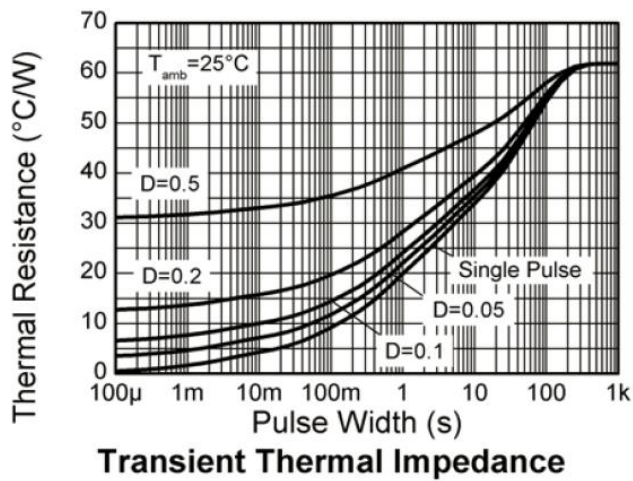
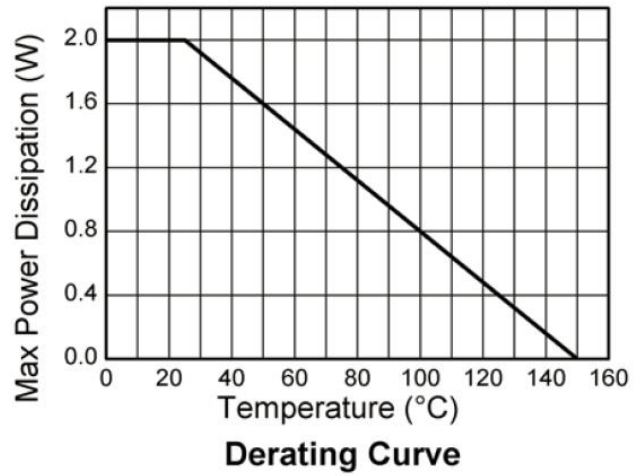
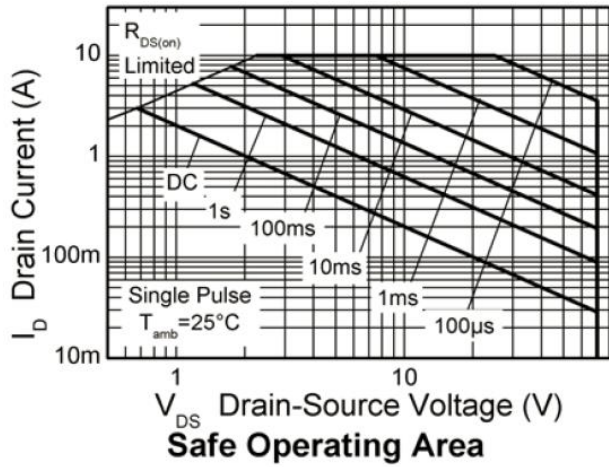

**Electrical Characteristics** (@T<sub>A</sub> = +25°C, unless otherwise specified.)

Characteristic	Symbol	Min	Typ	Max	Unit	Test Condition
<b>OFF CHARACTERISTICS</b>						
Drain-Source Breakdown Voltage	BV <sub>DSS</sub>	70	—	—	V	V <sub>GS</sub> = 0V, I <sub>D</sub> = 250μA
Zero Gate Voltage Drain Current	I <sub>DSS</sub>	—	—	1	μA	V <sub>DS</sub> = 70V, V <sub>GS</sub> = 0V
Gate-Source Leakage	I <sub>GSS</sub>	—	—	±100	nA	V <sub>GS</sub> = ±20V, V <sub>DS</sub> = 0V
<b>ON CHARACTERISTICS</b>						
Gate Threshold Voltage	V <sub>GS(th)</sub>	1.0	—	—	V	V <sub>DS</sub> = V <sub>GS</sub> , I <sub>D</sub> = 250μA
Static Drain-Source On-Resistance (Note 8)	R <sub>DS(on)</sub>	—	—	0.13	Ω	V <sub>GS</sub> = 10V, I <sub>D</sub> = 4.4A
		—	—	0.19		V <sub>GS</sub> = 4.5V, I <sub>D</sub> = 3.8A
Forward Transfer Admittance	g <sub>fs</sub>	—	4.66	—	S	V <sub>DS</sub> = 15V, I <sub>D</sub> = 4.4A
Diode Forward Voltage (Note 8)	V <sub>SD</sub>	—	0.85	0.95	V	T <sub>J</sub> = +25°C, V <sub>GS</sub> = 0V, I <sub>S</sub> = 2.5A
<b>DYNAMIC CHARACTERISTICS (Notes 9 &amp; 10)</b>						
Input Capacitance	C <sub>iss</sub>	—	298	—	pF	V <sub>DS</sub> = 50V, V <sub>GS</sub> = 0V f = 1.0MHz
Output Capacitance	C <sub>oss</sub>	—	35	—		
Reverse Transfer Capacitance	C <sub>rss</sub>	—	21	—		
Total Gate Charge	Q <sub>g</sub>	—	4.35	—	nC	V <sub>DS</sub> = 35V, V <sub>GS</sub> = 5.0V, I <sub>D</sub> = 4.4A
Total Gate Charge	Q <sub>g</sub>	—	7.4	—	nC	V <sub>DS</sub> = 35V, V <sub>GS</sub> = 10V, I <sub>D</sub> = 4.4A
Gate-Source Charge	Q <sub>gs</sub>	—	1.06	—		
Gate-Drain Charge	Q <sub>gd</sub>	—	1.8	—		
Turn-On Delay Time	t <sub>D(on)</sub>	—	1.9	—	ns	V <sub>DS</sub> = 35V, V <sub>GS</sub> = 10V, I <sub>D</sub> = 1 A, R <sub>G</sub> ≅ 6.0Ω
Turn-On Rise Time	t <sub>r</sub>	—	2	—		
Turn-Off Delay Time	t <sub>D(off)</sub>	—	11.5	—		
Turn-Off Fall Time	t <sub>f</sub>	—	5.8	—		
Body Diode Reverse Recovery Time	t <sub>rr</sub>	—	19.8	—	ns	T <sub>J</sub> = +25°C, I <sub>S</sub> = 2.5A,
Body Diode Reverse Recovery Charge	Q <sub>rr</sub>	—	14	—	nC	di/dt = 100A/μs

Notes: 8. Measured under pulsed conditions. Pulse width ≤ 300μs; duty cycle ≤ 2%.  
9. Switching characteristics are independent of operating junction temperature.  
10. For design aid only, not subject to production testing.

**Typical Characteristics**

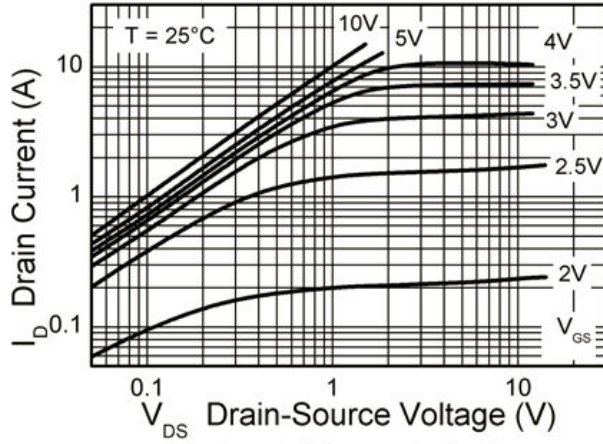

**Output Characteristics**

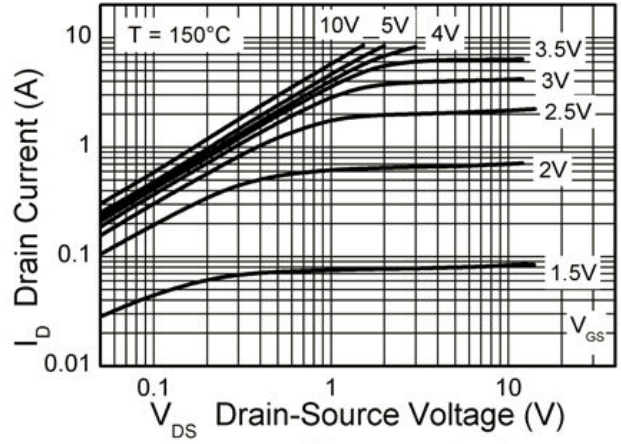

**Output Characteristics**

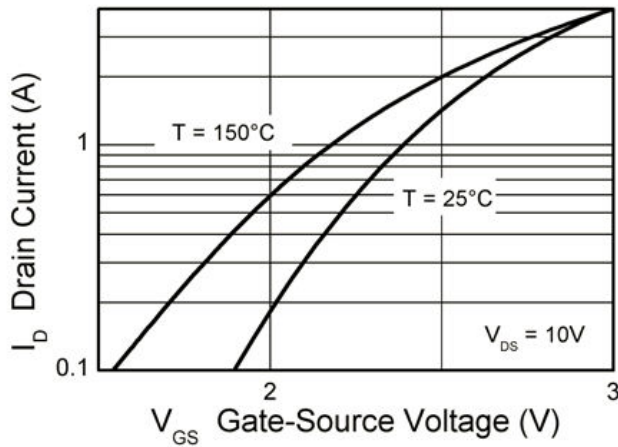

**Typical Transfer Characteristics**

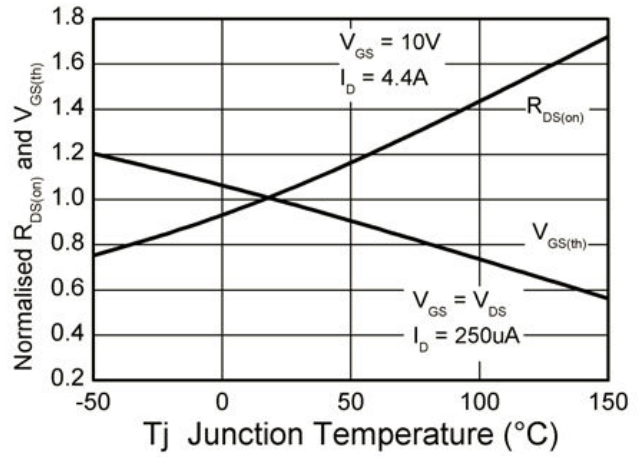

**Normalised Curves v Temperature**

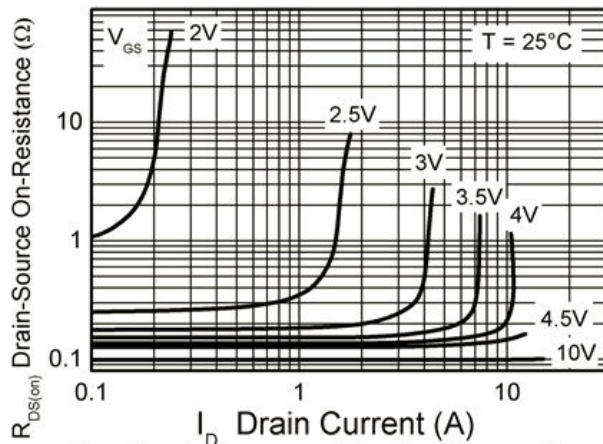

**On-Resistance v Drain Current**

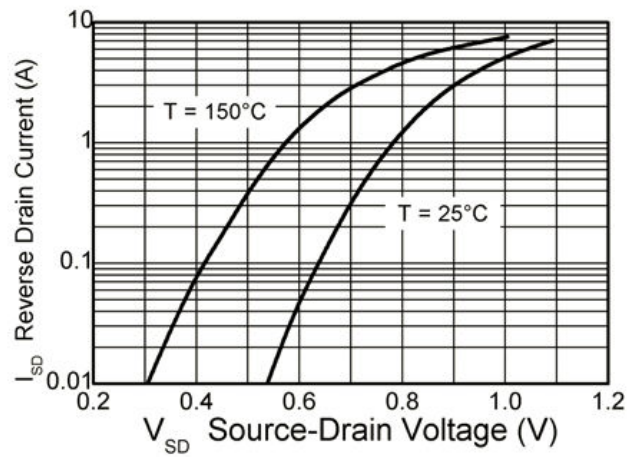

**Source-Drain Diode Forward Voltage**

**Typical Characteristics**

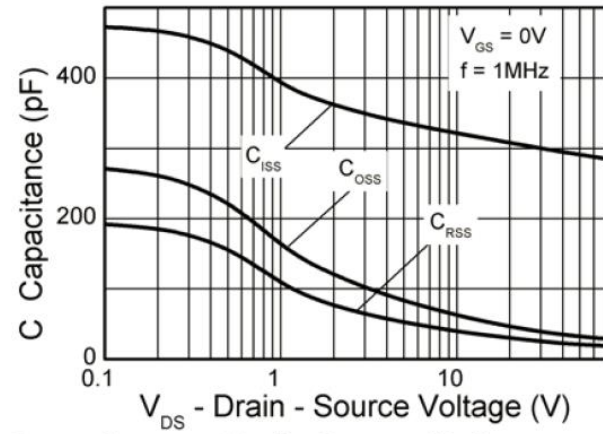

**Capacitance v Drain-Source Voltage**

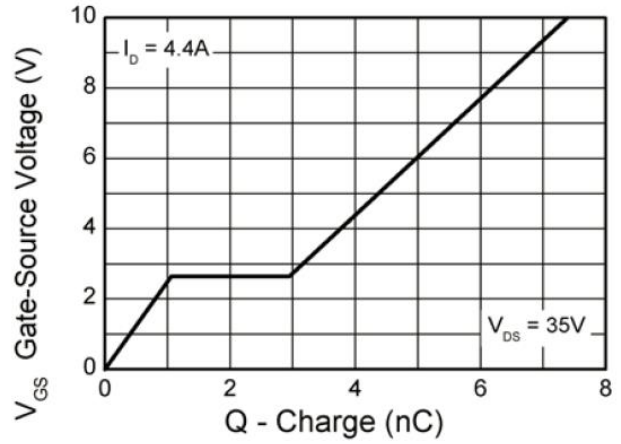

**Gate-Source Voltage v Gate Charge**



**Package Outline Dimensions**

Please see AP02002 at <http://www.diodes.com/datasheets/ap02002.pdf> for the latest version.

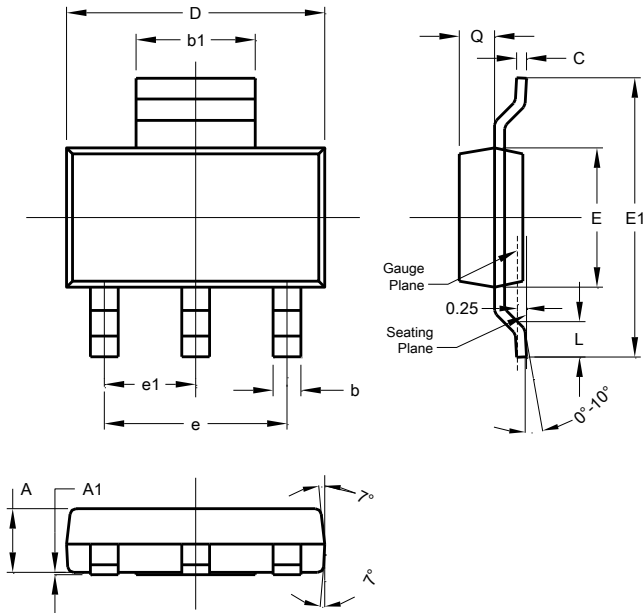

SOT223			
Dim	Min	Max	Typ
A	1.55	1.65	1.60
A1	0.010	0.15	0.05
b	0.60	0.80	0.70
b1	2.90	3.10	3.00
C	0.20	0.30	0.25
D	6.45	6.55	6.50
E	3.45	3.55	3.50
E1	6.90	7.10	7.00
e	-	-	4.60
e1	-	-	2.30
L	0.85	1.05	0.95
Q	0.84	0.94	0.89
All Dimensions in mm			

**Suggested Pad Layout**

Please see AP02001 at <http://www.diodes.com/datasheets/ap02001.pdf> for the latest version.

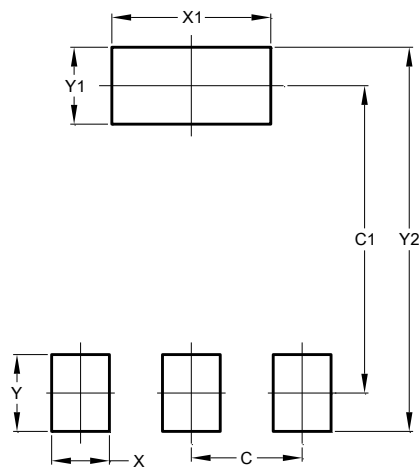

Dimensions	Value (in mm)
C	2.30
C1	6.40
X	1.20
X1	3.30
Y	1.60
Y1	1.60
Y2	8.00

**IMPORTANT NOTICE**

DIODES INCORPORATED MAKES NO WARRANTY OF ANY KIND, EXPRESS OR IMPLIED, WITH REGARDS TO THIS DOCUMENT, INCLUDING, BUT NOT LIMITED TO, THE IMPLIED WARRANTIES OF MERCHANTABILITY AND FITNESS FOR A PARTICULAR PURPOSE (AND THEIR EQUIVALENTS UNDER THE LAWS OF ANY JURISDICTION).

Diodes Incorporated and its subsidiaries reserve the right to make modifications, enhancements, improvements, corrections or other changes without further notice to this document and any product described herein. Diodes Incorporated does not assume any liability arising out of the application or use of this document or any product described herein; neither does Diodes Incorporated convey any license under its patent or trademark rights, nor the rights of others. Any Customer or user of this document or products described herein in such applications shall assume all risks of such use and will agree to hold Diodes Incorporated and all the companies whose products are represented on Diodes Incorporated website, harmless against all damages.

Diodes Incorporated does not warrant or accept any liability whatsoever in respect of any products purchased through unauthorized sales channel. Should Customers purchase or use Diodes Incorporated products for any unintended or unauthorized application, Customers shall indemnify and hold Diodes Incorporated and its representatives harmless against all claims, damages, expenses, and attorney fees arising out of, directly or indirectly, any claim of personal injury or death associated with such unintended or unauthorized application.

Products described herein may be covered by one or more United States, international or foreign patents pending. Product names and markings noted herein may also be covered by one or more United States, international or foreign trademarks.

This document is written in English but may be translated into multiple languages for reference. Only the English version of this document is the final and determinative format released by Diodes Incorporated.

**LIFE SUPPORT**

Diodes Incorporated products are specifically not authorized for use as critical components in life support devices or systems without the express written approval of the Chief Executive Officer of Diodes Incorporated. As used herein:

A. Life support devices or systems are devices or systems which:

1. are intended to implant into the body, or
2. support or sustain life and whose failure to perform when properly used in accordance with instructions for use provided in the labeling can be reasonably expected to result in significant injury to the user.

B. A critical component is any component in a life support device or system whose failure to perform can be reasonably expected to cause the failure of the life support device or to affect its safety or effectiveness.

Customers represent that they have all necessary expertise in the safety and regulatory ramifications of their life support devices or systems, and acknowledge and agree that they are solely responsible for all legal, regulatory and safety-related requirements concerning their products and any use of Diodes Incorporated products in such safety-critical, life support devices or systems, notwithstanding any devices- or systems-related information or support that may be provided by Diodes Incorporated. Further, Customers must fully indemnify Diodes Incorporated and its representatives against any damages arising out of the use of Diodes Incorporated products in such safety-critical, life support devices or systems.

Copyright © 2015, Diodes Incorporated

[www.diodes.com](http://www.diodes.com)