

## MOSFET

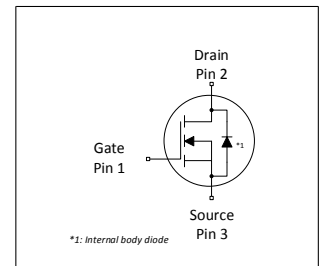
### 650V CoolMOS™ C7 Power Device

CoolMOS™ is a revolutionary technology for high voltage power MOSFETs, designed according to the superjunction (SJ) principle and pioneered by Infineon Technologies.

CoolMOS™ C7 series combines the experience of the leading SJ MOSFET supplier with high class innovation. The product portfolio provides all benefits of fast switching superjunction MOSFETs offering better efficiency, reduced gate charge, easy implementation and outstanding reliability.



PG-TO 220 FP



### Features

- Increased MOSFET dv/dt ruggedness
- Better efficiency due to best in class FOM  $R_{DS(on)} * E_{oss}$  and  $R_{DS(on)} * Q_g$
- Best in class  $R_{DS(on)}$  /package
- Easy to use/drive
- Pb-free plating, halogen free mold compound

### Benefits

- Enabling higher system efficiency
- Enabling higher frequency / increased power density solutions
- System cost / size savings due to reduced cooling requirements
- Higher system reliability due to lower operating temperatures

### Potential applications

PFC stages and hard switching PWM stages for e.g. Computing, Server, Telecom, UPS and Solar.

### Product validation

Fully qualified according to JEDEC for Industrial Applications

*Please note: For MOSFET paralleling the use of ferrite beads on the gate or separate totem poles is generally recommended.*

**Table 1 Key Performance Parameters**

Parameter	Value	Unit
$V_{DS} @ T_{j,max}$	700	V
$R_{DS(on),max}$	190	mΩ
$Q_{g,typ}$	23	nC
$I_{D,pulse}$	49	A
$E_{oss@400V}$	2.7	μJ
Body diode di/dt	55	A/μs

Type / Ordering Code	Package	Marking	Related Links
IPA65R190C7	PG-TO220 FullIPAK	65C7190	see Appendix A

## Table of Contents

Description .....	1
Maximum ratings .....	3
Thermal characteristics .....	4
Electrical characteristics .....	5
Electrical characteristics diagrams .....	7
Test Circuits .....	11
Package Outlines .....	12
Appendix A .....	13
Revision History .....	14
Trademarks .....	14
Disclaimer .....	14

## 1 Maximum ratings

at  $T_j = 25^\circ\text{C}$ , unless otherwise specified

**Table 2 Maximum ratings**

Parameter	Symbol	Values			Unit	Note / Test Condition
		Min.	Typ.	Max.		
Continuous drain current <sup>1)</sup>	$I_D$	-	-	8 5	A	$T_C=25^\circ\text{C}$ $T_C=100^\circ\text{C}$
Pulsed drain current <sup>2)</sup>	$I_{D,pulse}$	-	-	49	A	$T_C=25^\circ\text{C}$
Avalanche energy, single pulse	$E_{AS}$	-	-	57	mJ	$I_D=5.4\text{A}$ ; $V_{DD}=50\text{V}$ ; see table 10
Avalanche energy, repetitive	$E_{AR}$	-	-	0.29	mJ	$I_D=5.4\text{A}$ ; $V_{DD}=50\text{V}$ ; see table 10
Avalanche current, single pulse	$I_{AS}$	-	-	5.4	A	-
MOSFET dv/dt ruggedness	dv/dt	-	-	100	V/ns	$V_{DS}=0\dots400\text{V}$
Gate source voltage (static)	$V_{GS}$	-20	-	20	V	static;
Gate source voltage (dynamic)	$V_{GS}$	-30	-	30	V	AC ( $f>1\text{ Hz}$ )
Power dissipation	$P_{tot}$	-	-	30	W	$T_C=25^\circ\text{C}$
Storage temperature	$T_{stg}$	-55	-	150	$^\circ\text{C}$	-
Operating junction temperature	$T_j$	-55	-	150	$^\circ\text{C}$	-
Mounting torque	-	-	-	50	Ncm	M2.5 screws
Continuous diode forward current	$I_S$	-	-	8	A	$T_C=25^\circ\text{C}$
Diode pulse current <sup>2)</sup>	$I_{S,pulse}$	-	-	49	A	$T_C=25^\circ\text{C}$
Reverse diode dv/dt <sup>3)</sup>	dv/dt	-	-	1	V/ns	$V_{DS}=0\dots400\text{V}$ , $I_{SD}\leq I_S$ , $T_j=25^\circ\text{C}$ see table 8
Maximum diode commutation speed	di/dt	-	-	55	A/ $\mu\text{s}$	$V_{DS}=0\dots400\text{V}$ , $I_{SD}\leq I_S$ , $T_j=25^\circ\text{C}$ see table 8
Insulation withstand voltage	$V_{ISO}$	-	-	2500	V	$V_{rms}$ , $T_C=25^\circ\text{C}$ , $t=1\text{ min}$

<sup>1)</sup> Limited by  $T_{j,max}$ .

<sup>2)</sup> Pulse width  $t_p$  limited by  $T_{j,max}$

<sup>3)</sup> Identical low side and high side switch with identical  $R_\theta$

## 2 Thermal characteristics

**Table 3 Thermal characteristics**

Parameter	Symbol	Values			Unit	Note / Test Condition
		Min.	Typ.	Max.		
Thermal resistance, junction - case	$R_{thJC}$	-	-	4.21	°C/W	-
Thermal resistance, junction - ambient	$R_{thJA}$	-	-	80	°C/W	leaded
Thermal resistance, junction - ambient for SMD version	$R_{thJA}$	-	-	-	°C/W	n.a.
Reflow soldering temperature	$T_{sold}$	-	-	260	°C	1.6mm (0.063 in.) from case for 10s

### 3 Electrical characteristics

at  $T_j=25^\circ\text{C}$ , unless otherwise specified

**Table 4 Static characteristics**

Parameter	Symbol	Values			Unit	Note / Test Condition
		Min.	Typ.	Max.		
Drain-source breakdown voltage	$V_{(BR)DSS}$	650	-	-	V	$V_{GS}=0V, I_D=1mA$
Gate threshold voltage	$V_{(GS)th}$	3	3.5	4	V	$V_{DS}=V_{GS}, I_D=0.29mA$
Zero gate voltage drain current	$I_{DSS}$	-	-	1	$\mu\text{A}$	$V_{DS}=650, V_{GS}=0V, T_j=25^\circ\text{C}$ $V_{DS}=650, V_{GS}=0V, T_j=150^\circ\text{C}$
Gate-source leakage current	$I_{GSS}$	-	-	100	nA	$V_{GS}=20V, V_{DS}=0V$
Drain-source on-state resistance	$R_{DS(on)}$	-	0.168 0.404	0.190 -	$\Omega$	$V_{GS}=10V, I_D=5.7A, T_j=25^\circ\text{C}$ $V_{GS}=10V, I_D=5.7A, T_j=150^\circ\text{C}$
Gate resistance	$R_G$	-	1.1	-	$\Omega$	$f=1\text{MHz}$ , open drain

**Table 5 Dynamic characteristics**

Parameter	Symbol	Values			Unit	Note / Test Condition
		Min.	Typ.	Max.		
Input capacitance	$C_{iss}$	-	1150	-	pF	$V_{GS}=0V, V_{DS}=400V, f=250\text{kHz}$
Output capacitance	$C_{oss}$	-	17	-	pF	$V_{GS}=0V, V_{DS}=400V, f=250\text{kHz}$
Effective output capacitance, energy related <sup>1)</sup>	$C_{o(er)}$	-	34	-	pF	$V_{GS}=0V, V_{DS}=0\dots400V$
Effective output capacitance, time related <sup>2)</sup>	$C_{o(tr)}$	-	374	-	pF	$I_D=\text{constant}, V_{GS}=0V, V_{DS}=0\dots400V$
Turn-on delay time	$t_{d(on)}$	-	11	-	ns	$V_{DD}=400V, V_{GS}=13V, I_D=5.7A,$ $R_G=10\Omega$ ; see table 9
Rise time	$t_r$	-	11	-	ns	$V_{DD}=400V, V_{GS}=13V, I_D=5.7A,$ $R_G=10\Omega$ ; see table 9
Turn-off delay time	$t_{d(off)}$	-	54	-	ns	$V_{DD}=400V, V_{GS}=13V, I_D=5.7A,$ $R_G=10\Omega$ ; see table 9
Fall time	$t_f$	-	9	-	ns	$V_{DD}=400V, V_{GS}=13V, I_D=5.7A,$ $R_G=10\Omega$ ; see table 9

**Table 6 Gate charge characteristics**

Parameter	Symbol	Values			Unit	Note / Test Condition
		Min.	Typ.	Max.		
Gate to source charge	$Q_{GS}$	-	6	-	nC	$V_{DD}=400V, I_D=5.7A, V_{GS}=0$ to 10V
Gate to drain charge	$Q_{gd}$	-	7	-	nC	$V_{DD}=400V, I_D=5.7A, V_{GS}=0$ to 10V
Gate charge total	$Q_g$	-	23	-	nC	$V_{DD}=400V, I_D=5.7A, V_{GS}=0$ to 10V
Gate plateau voltage	$V_{plateau}$	-	5.4	-	V	$V_{DD}=400V, I_D=5.7A, V_{GS}=0$ to 10V

<sup>1)</sup>  $C_{o(er)}$  is a fixed capacitance that gives the same stored energy as  $C_{oss}$  while  $V_{DS}$  is rising from 0 to 400V

<sup>2)</sup>  $C_{o(tr)}$  is a fixed capacitance that gives the same charging time as  $C_{oss}$  while  $V_{DS}$  is rising from 0 to 400V

**Table 7 Reverse diode characteristics**

Parameter	Symbol	Values			Unit	Note / Test Condition
		Min.	Typ.	Max.		
Diode forward voltage	$V_{SD}$	-	0.9	-	V	$V_{GS}=0V, I_F=5.7A, T_j=25^{\circ}C$
Reverse recovery time	$t_{rr}$	-	830	-	ns	$V_R=400V, I_F=8A, di_F/dt=55A/\mu s$ ; see table 8
Reverse recovery charge	$Q_{rr}$	-	6.5	-	$\mu C$	$V_R=400V, I_F=8A, di_F/dt=55A/\mu s$ ; see table 8
Peak reverse recovery current	$I_{rrm}$	-	18	-	A	$V_R=400V, I_F=8A, di_F/dt=55A/\mu s$ ; see table 8

### 4 Electrical characteristics diagrams

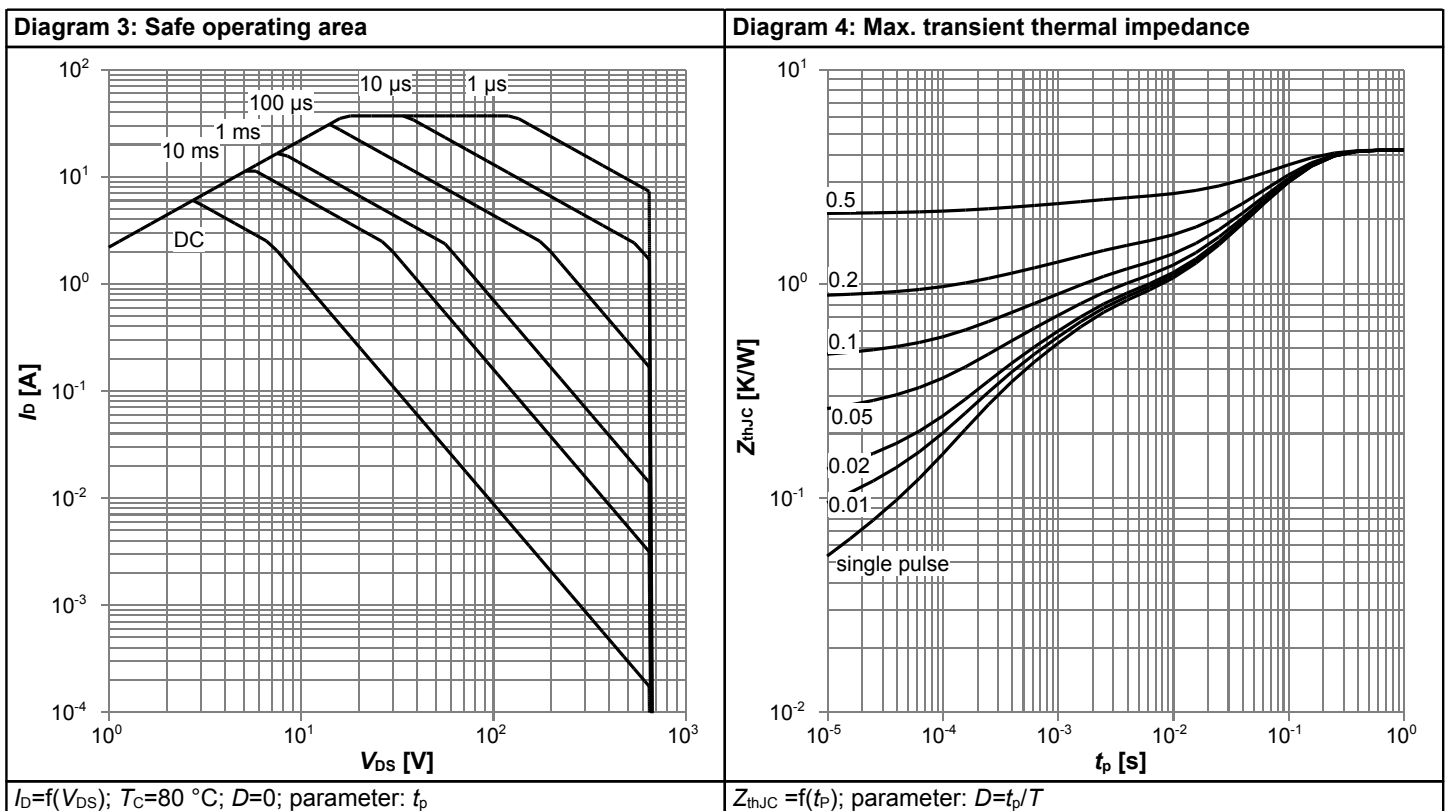
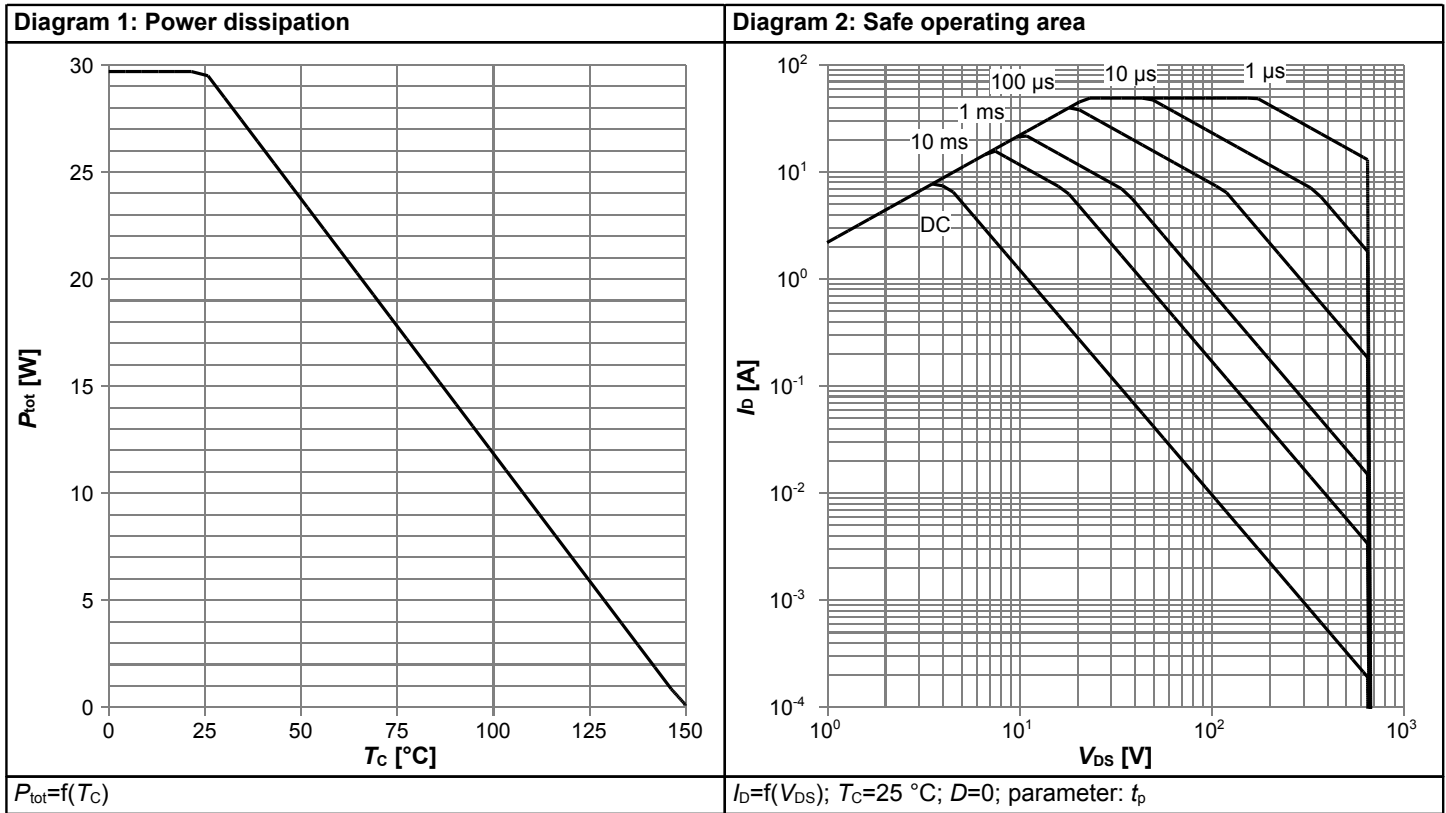
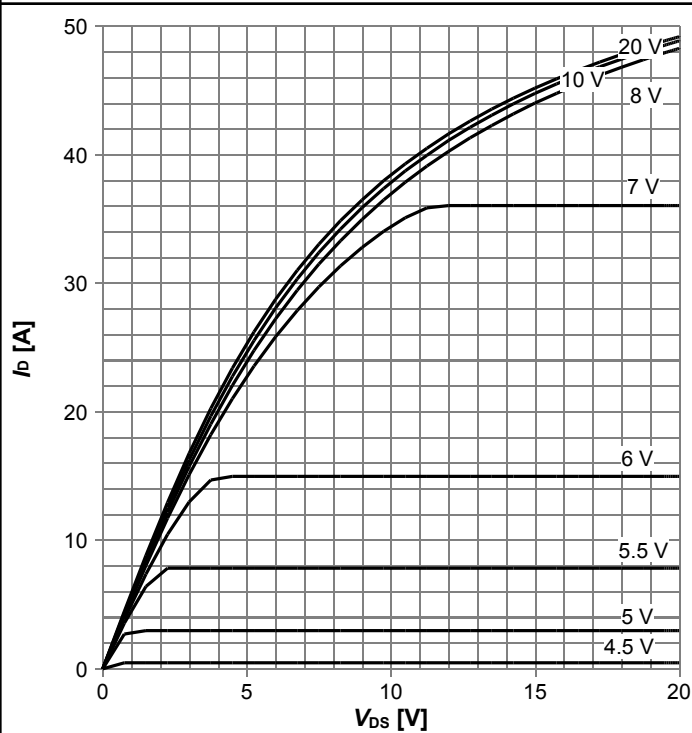
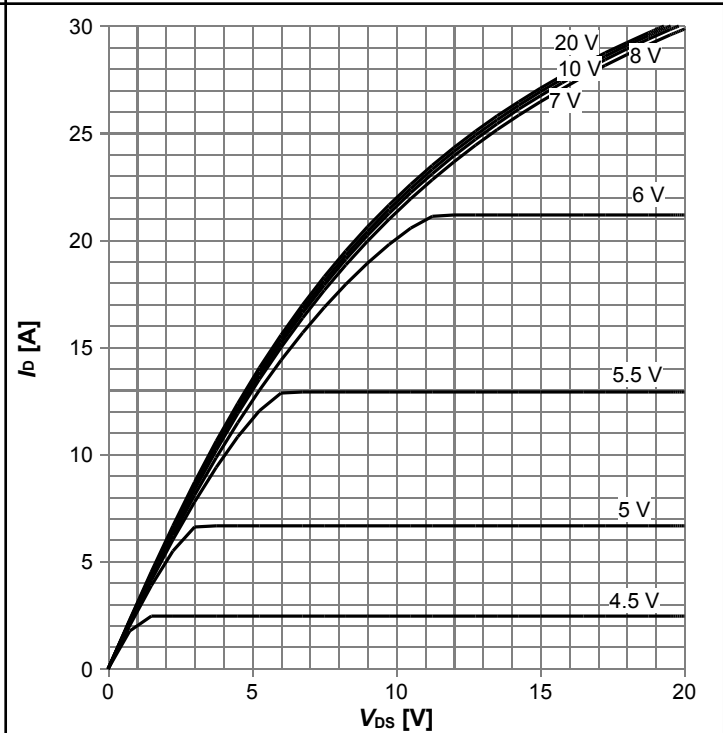


Diagram 5: Typ. output characteristics



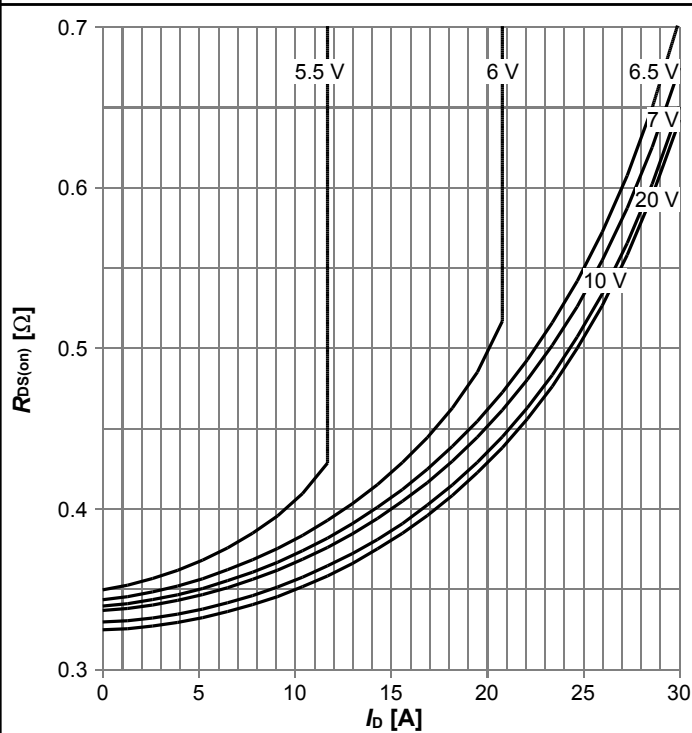
$I_D=f(V_{DS})$ ;  $T_j=25\text{ °C}$ ; parameter:  $V_{GS}$

Diagram 6: Typ. output characteristics



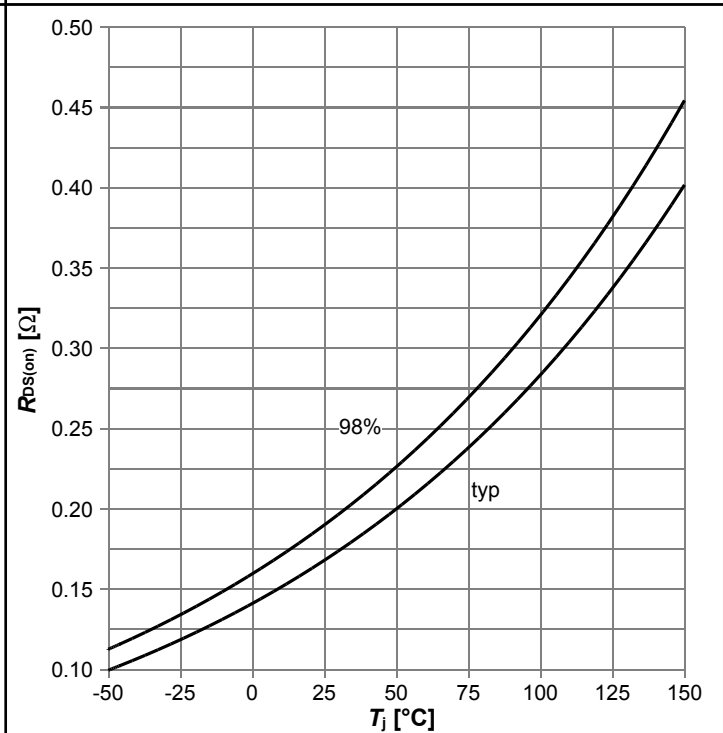
$I_D=f(V_{DS})$ ;  $T_j=125\text{ °C}$ ; parameter:  $V_{GS}$

Diagram 7: Typ. drain-source on-state resistance



$R_{DS(on)}=f(I_D)$ ;  $T_j=125\text{ °C}$ ; parameter:  $V_{GS}$

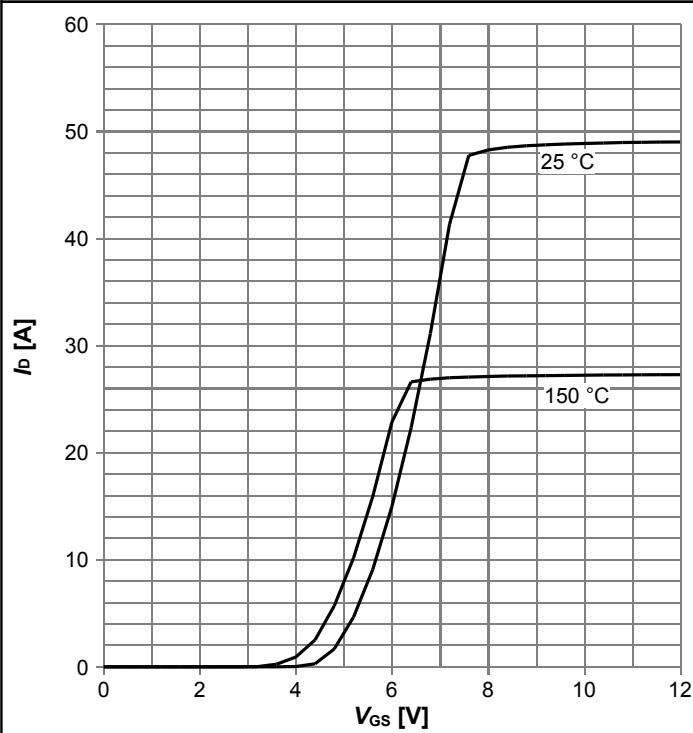
Diagram 8: Drain-source on-state resistance



$R_{DS(on)}=f(T_j)$ ;  $I_D=5.7\text{ A}$ ;  $V_{GS}=10\text{ V}$

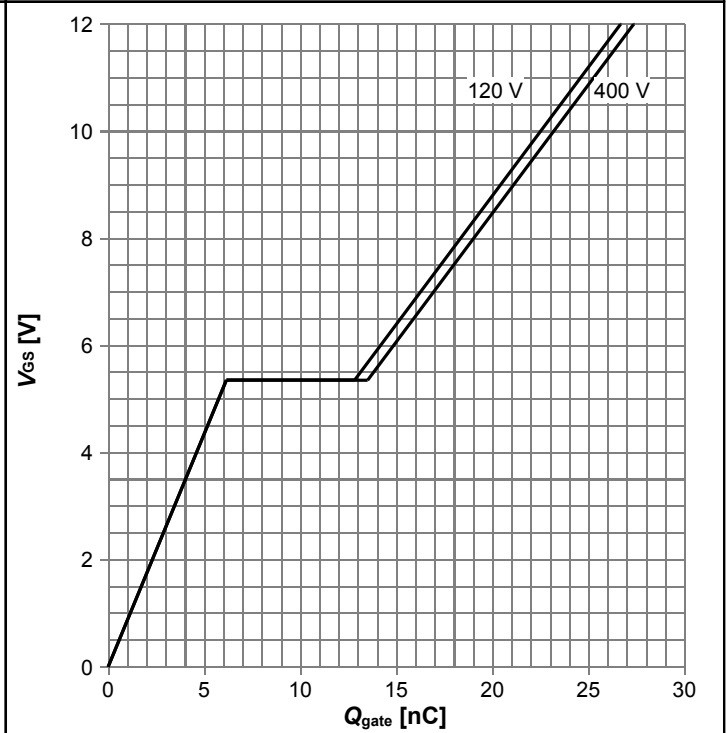


Diagram 9: Typ. transfer characteristics



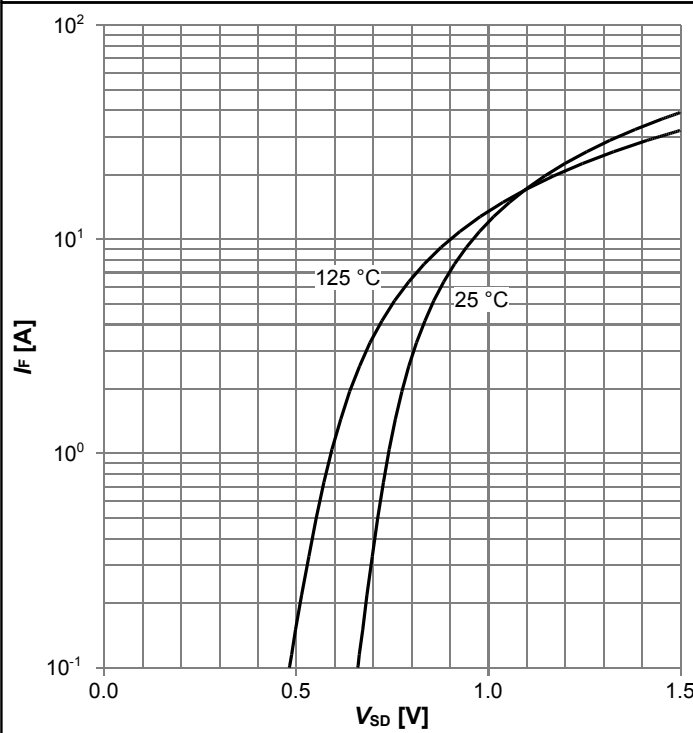
$I_D = f(V_{GS})$ ;  $V_{DS} = 20V$ ; parameter:  $T_j$

Diagram 10: Typ. gate charge



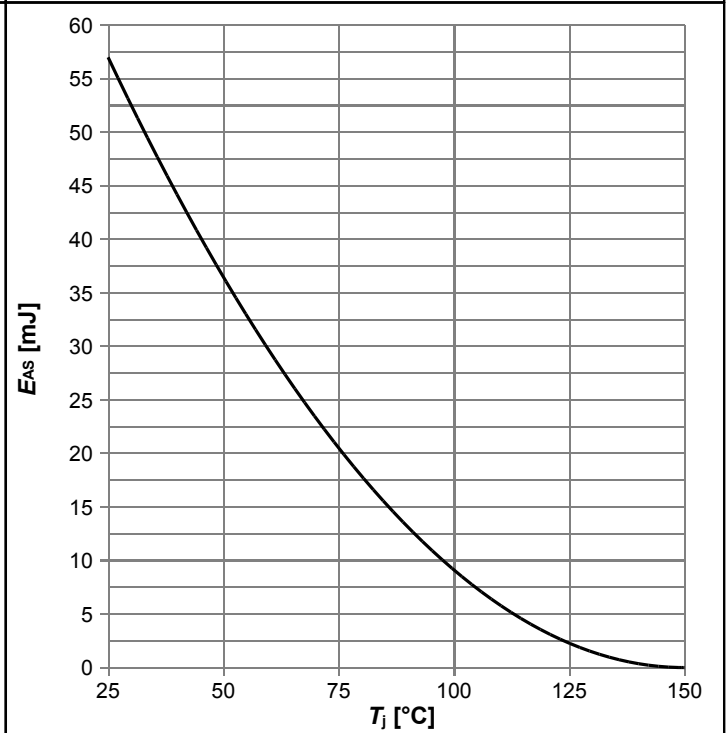
$V_{GS} = f(Q_{gate})$ ;  $I_D = 5.7A$  pulsed; parameter:  $V_{DD}$

Diagram 11: Forward characteristics of reverse diode



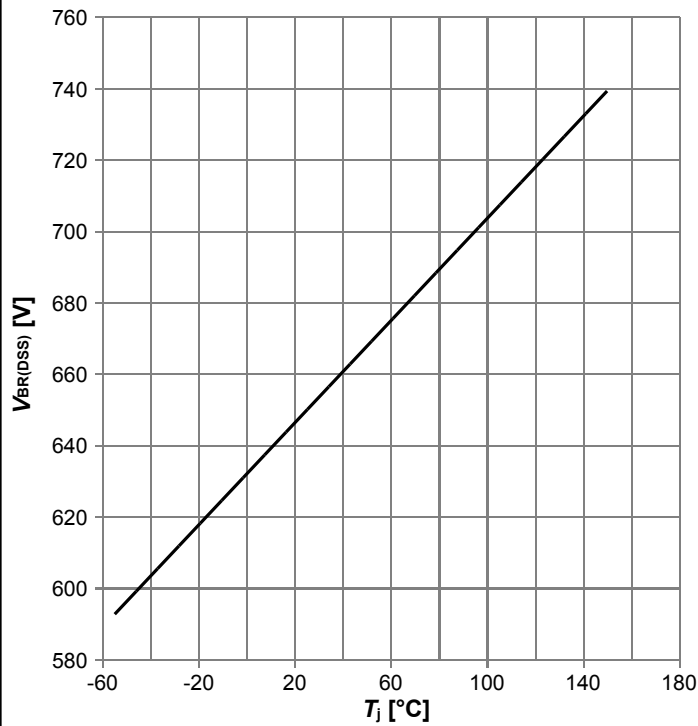
$I_F = f(V_{SD})$ ; parameter:  $T_j$

Diagram 12: Avalanche energy



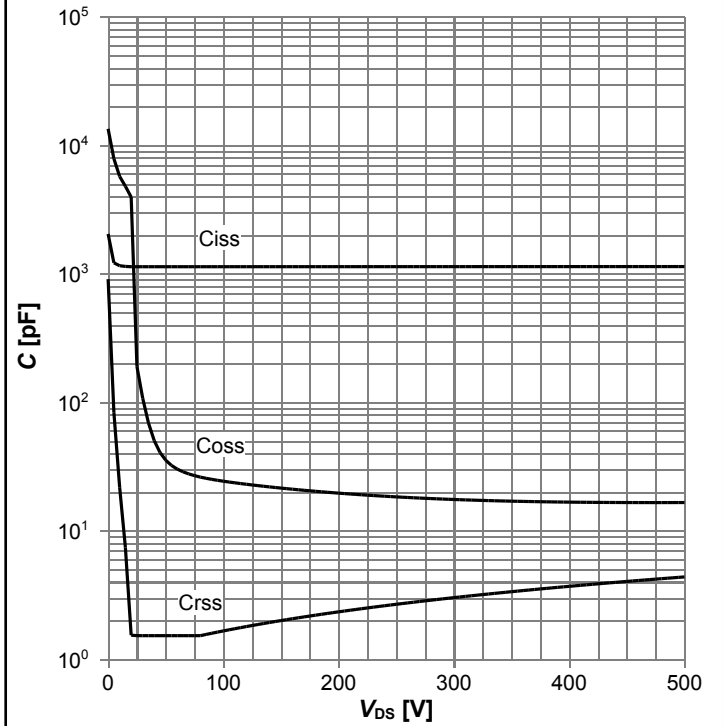
$E_{AS} = f(T_j)$ ;  $I_D = 5.4 A$ ;  $V_{DD} = 50 V$

**Diagram 13: Drain-source breakdown voltage**



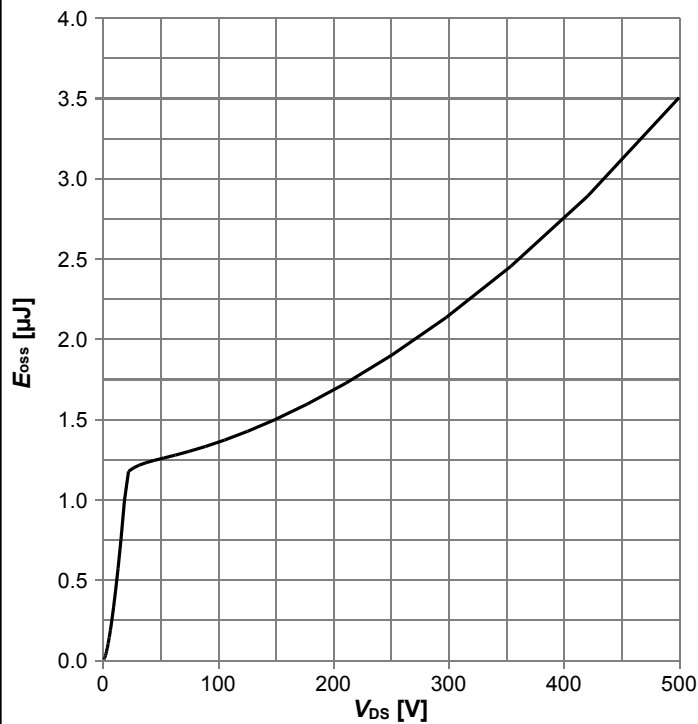
$V_{BR(DSS)}=f(T_j); I_D=1\text{ mA}$

**Diagram 14: Typ. capacitances**



$C=f(V_{DS}); V_{GS}=0\text{ V}; f=250\text{ kHz}$

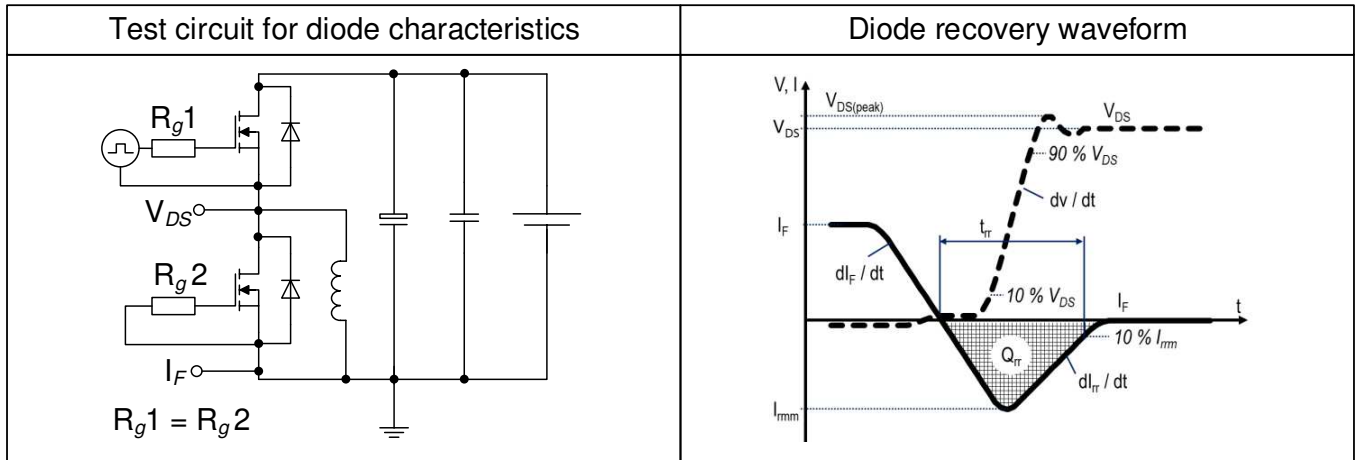
**Diagram 15: Typ. Coss stored energy**



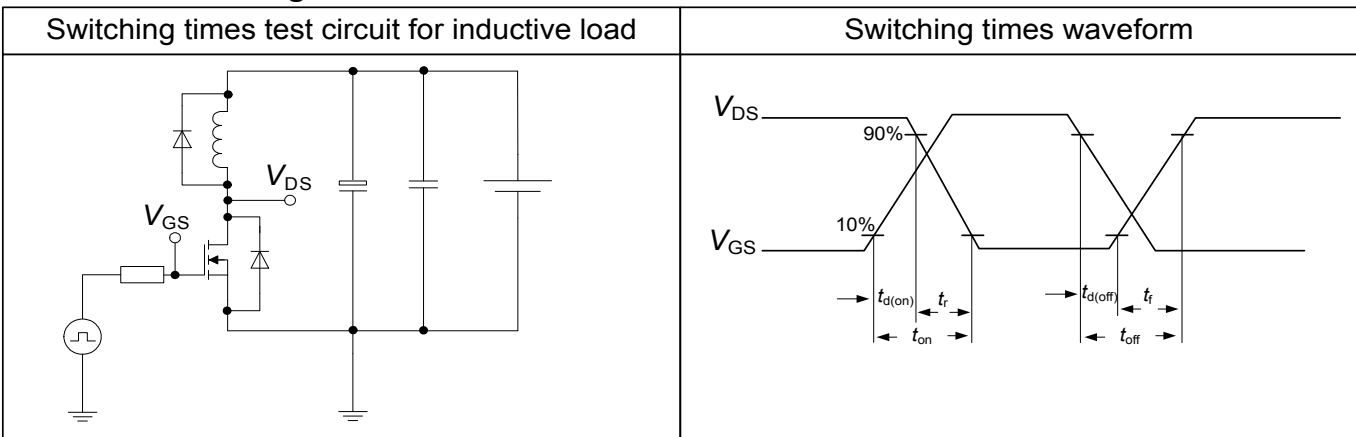
$E_{oss}=f(V_{DS})$

## 5 Test Circuits

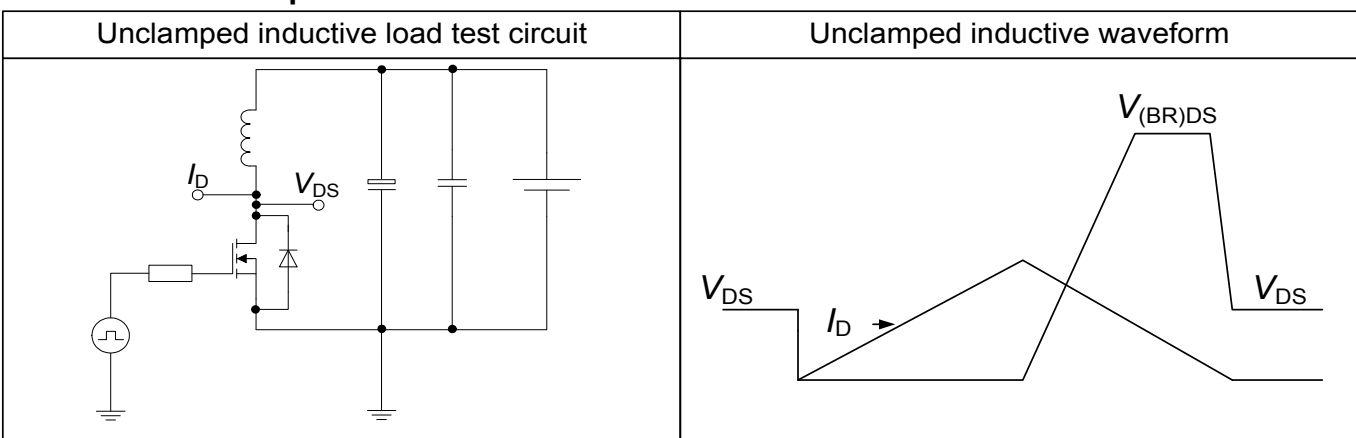
**Table 8 Diode characteristics**



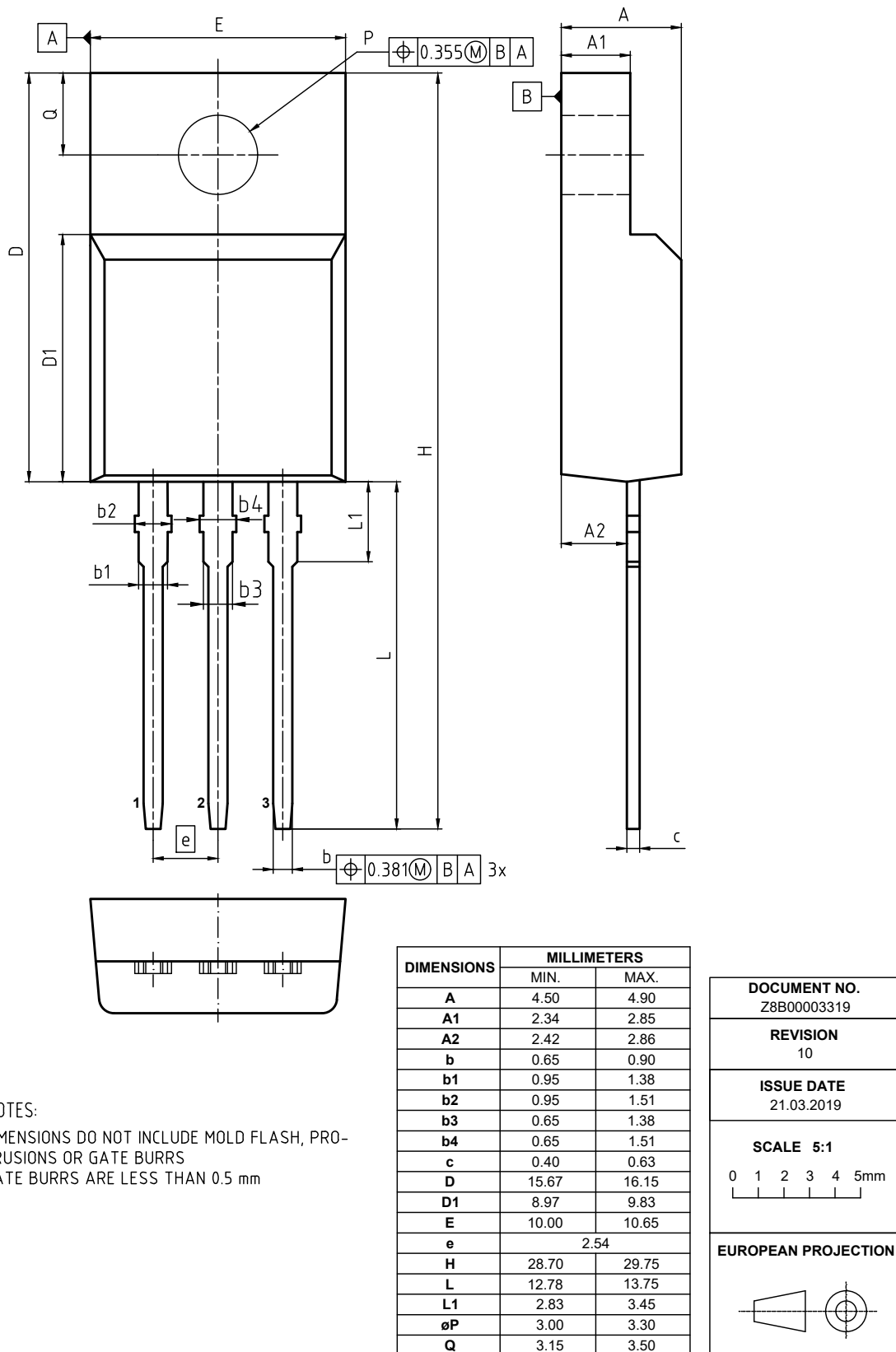
**Table 9 Switching times**



**Table 10 Unclamped inductive load**



## 6 Package Outlines



**Figure 1 Outline PG-TO220 FullPAK, dimensions in mm**

## **7 Appendix A**

### **Table 11 Related Links**

- IFX CoolMOS™ C7 Webpage: [www.infineon.com](http://www.infineon.com)
- IFX CoolMOS™ C7 application note: [www.infineon.com](http://www.infineon.com)
- IFX CoolMOS™ C7 simulation model: [www.infineon.com](http://www.infineon.com)
- IFX Design tools: [www.infineon.com](http://www.infineon.com)

## Revision History

IPA65R190C7

**Revision: 2020-02-17, Rev. 2.1**

Previous Revision

Revision	Date	Subjects (major changes since last revision)
2.0	2013-10-18	Release of final version
2.1	2020-02-17	Updated package drawing, symbol ID and product validation

### Trademarks

All referenced product or service names and trademarks are the property of their respective owners.

### We Listen to Your Comments

Any information within this document that you feel is wrong, unclear or missing at all? Your feedback will help us to continuously improve the quality of this document. Please send your proposal (including a reference to this document) to:

**erratum@infineon.com**

### Published by

**Infineon Technologies AG**

**81726 München, Germany**

**© 2020 Infineon Technologies AG**

**All Rights Reserved.**

### Legal Disclaimer

The information given in this document shall in no event be regarded as a guarantee of conditions or characteristics ("Beschaffenheitsgarantie").

With respect to any examples, hints or any typical values stated herein and/or any information regarding the application of the product, Infineon Technologies hereby disclaims any and all warranties and liabilities of any kind, including without limitation warranties of non-infringement of intellectual property rights of any third party.

In addition, any information given in this document is subject to customer's compliance with its obligations stated in this document and any applicable legal requirements, norms and standards concerning customer's products and any use of the product of Infineon Technologies in customer's applications.

The data contained in this document is exclusively intended for technically trained staff. It is the responsibility of customer's technical departments to evaluate the suitability of the product for the intended application and the completeness of the product information given in this document with respect to such application.

### Information

For further information on technology, delivery terms and conditions and prices please contact your nearest Infineon Technologies Office ([www.infineon.com](http://www.infineon.com)).

### Warnings

Due to technical requirements, components may contain dangerous substances. For information on the types in question, please contact the nearest Infineon Technologies Office.

The Infineon Technologies component described in this Data Sheet may be used in life-support devices or systems and/or automotive, aviation and aerospace applications or systems only with the express written approval of Infineon Technologies, if a failure of such components can reasonably be expected to cause the failure of that life-support, automotive, aviation and aerospace device or system or to affect the safety or effectiveness of that device or system. Life support devices or systems are intended to be implanted in the human body or to support and/or maintain and sustain and/or protect human life. If they fail, it is reasonable to assume that the health of the user or other persons may be endangered.