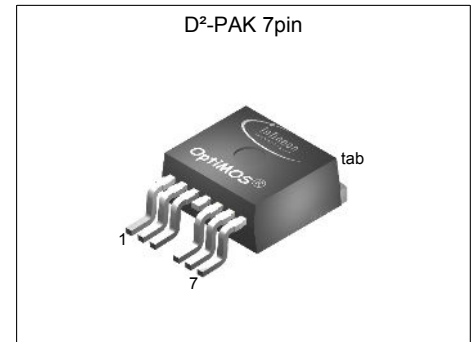


# MOSFET

## OptiMOS™ 3 Power-Transistor, 30 V

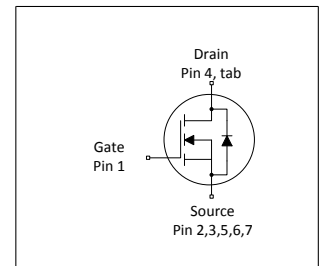
### Features

- MOSFET for ORing and Uninterruptible Power Supply
- Qualified according to JEDEC<sup>1)</sup> for target applications
- N-channel
- Logic level
- Ultra-low on-resistance  $R_{DS(on)}$
- 100% Avalanche tested
- Pb-free plating; RoHS compliant



**Table 1 Key Performance Parameters**

| Parameter        | Value | Unit       |
|------------------|-------|------------|
| $V_{DS}$         | 30    | V          |
| $R_{DS(on),max}$ | 0.95  | m $\Omega$ |
| $I_D$            | 180   | A          |



| Type / Ordering Code | Package    | Marking | Related Links |
|----------------------|------------|---------|---------------|
| IPB009N03L G         | PG-TO263-7 | 009N03L | -             |

<sup>1)</sup> J-STD20 and JESD22

## Table of Contents

|   |    |
|---|----|
| Description .....                         | 1  |
| Maximum ratings .....                     | 3  |
| Thermal characteristics .....             | 3  |
| Electrical characteristics .....          | 4  |
| Electrical characteristics diagrams ..... | 6  |
| Package Outlines .....                    | 10 |
| Revision History .....                    | 11 |
| Trademarks .....                          | 11 |
| Disclaimer .....                          | 11 |

## 1 Maximum ratings

at  $T_A=25\text{ °C}$ , unless otherwise specified

**Table 2 Maximum ratings**

| Parameter                                     | Symbol            | Values |      |      | Unit               | Note / Test Condition  |
|---|-------------------|--------|------|------|--------------------|--|
|   |                   | Min.   | Typ. | Max. |                    |  |
| Continuous drain current                      | $I_D$             | -      | -    | 180  | A                  | $V_{GS}=10\text{ V}$ , $T_C=25\text{ °C}$<br>$V_{GS}=10\text{ V}$ , $T_C=100\text{ °C}$<br>$V_{GS}=4.5\text{ V}$ , $T_C=25\text{ °C}$<br>$V_{GS}=4.5\text{ V}$ , $T_C=100\text{ °C}$ |
|   |                   | -      | -    | 180  |                    |  |
|   |                   | -      | -    | 180  |                    |  |
|   |                   | -      | -    | 180  |                    |  |
| Pulsed drain current <sup>1)</sup>            | $I_{D,pulse}$     | -      | -    | 1260 | A                  | $T_C=25\text{ °C}$   |
| Avalanche current, single pulse <sup>2)</sup> | $I_{AS}$          | -      | -    | 100  | A                  | $T_C=25\text{ °C}$   |
| Avalanche energy, single pulse                | $E_{AS}$          | -      | -    | 610  | mJ                 | $I_D=100\text{ A}$ , $R_{GS}=25\text{ }\Omega$   |
| Reverse diode $dv/dt$                         | $dv/dt$           | -      | -    | 6    | kV/ $\mu$ s        | $I_D=180\text{ A}$ , $V_{DS}=24\text{ V}$ , $di/dt=200\text{ A}/\mu$ s,<br>$T_{j,max}=175\text{ °C}$   |
| Gate source voltage                           | $V_{GS}$          | -20    | -    | 20   | V                  | -  |
| Power dissipation                             | $P_{tot}$         | -      | -    | 250  | W                  | $T_C=25\text{ °C}$   |
| Operating and storage temperature             | $T_j$ , $T_{stg}$ | -55    | -    | 175  | $^{\circ}\text{C}$ | IEC climatic category;<br>DIN IEC 68-1: 55/175/56  |

## 2 Thermal characteristics

**Table 3 Thermal characteristics**

| Parameter   | Symbol     | Values |      |      | Unit | Note / Test Condition |
|---|------------|--------|------|------|------|-----------------------|
|   |            | Min.   | Typ. | Max. |      |                       |
| Thermal resistance, junction - case   | $R_{thJC}$ | -      | -    | 0.6  | K/W  | -                     |
| SMD version, device on PCB,<br>minimal footprint                            | $R_{thJA}$ | -      | -    | 62   | K/W  | -                     |
| SMD version, device on PCB,<br>6 cm <sup>2</sup> cooling area <sup>3)</sup> | $R_{thJA}$ | -      | -    | 40   | K/W  | -                     |

<sup>1)</sup> See Diagram 3 for more detailed information

<sup>2)</sup> See Diagram 13 for more detailed information

<sup>3)</sup> Device on 40 mm x 40 mm x 1.5 mm epoxy PCB FR4 with 6 cm<sup>2</sup> (one layer, 70  $\mu$ m thick) copper area for drain connection. PCB is vertical in still air.

### 3 Electrical characteristics

**Table 4 Static characteristics**

| Parameter                        | Symbol        | Values |             |             | Unit             | Note / Test Condition   |
|----------------------------------|---------------|--------|-------------|-------------|------------------|---|
|                                  |               | Min.   | Typ.        | Max.        |                  |   |
| Drain-source breakdown voltage   | $V_{(BR)DSS}$ | 30     | -           | -           | V                | $V_{GS}=0\text{ V}$ , $I_D=1\text{ mA}$   |
| Gate threshold voltage           | $V_{GS(th)}$  | 1      | -           | 2.2         | V                | $V_{DS}=V_{GS}$ , $I_D=250\text{ }\mu\text{A}$  |
| Zero gate voltage drain current  | $I_{DSS}$     | -      | 0.1<br>20   | 2<br>200    | $\mu\text{A}$    | $V_{DS}=30\text{ V}$ , $V_{GS}=0\text{ V}$ , $T_j=25\text{ }^\circ\text{C}$<br>$V_{DS}=30\text{ V}$ , $V_{GS}=0\text{ V}$ , $T_j=125\text{ }^\circ\text{C}$ |
| Gate-source leakage current      | $I_{GSS}$     | -      | 10          | 100         | nA               | $V_{GS}=20\text{ V}$ , $V_{DS}=0\text{ V}$  |
| Drain-source on-state resistance | $R_{DS(on)}$  | -      | 0.95<br>0.7 | 1.3<br>0.95 | $\text{m}\Omega$ | $V_{GS}=4.5\text{ V}$ , $I_D=100\text{ A}$<br>$V_{GS}=10\text{ V}$ , $I_D=100\text{ A}$   |
| Gate resistance                  | $R_G$         | -      | 1.5         | -           | $\Omega$         | -   |
| Transconductance                 | $g_{fs}$      | 180    | 370         | -           | S                | $ V_{DS} >2 I_D R_{DS(on)max}$ , $I_D=100\text{ A}$   |

**Table 5 Dynamic characteristics**

| Parameter                    | Symbol       | Values |       |       | Unit | Note / Test Condition   |
|------------------------------|--------------|--------|-------|-------|------|---|
|                              |              | Min.   | Typ.  | Max.  |      |   |
| Input capacitance            | $C_{iss}$    | -      | 19000 | 25000 | pF   | $V_{GS}=0\text{ V}$ , $V_{DS}=15\text{ V}$ , $f=1\text{ MHz}$                                       |
| Output capacitance           | $C_{oss}$    | -      | 5700  | 7600  | pF   | $V_{GS}=0\text{ V}$ , $V_{DS}=15\text{ V}$ , $f=1\text{ MHz}$                                       |
| Reverse transfer capacitance | $C_{rss}$    | -      | 360   | -     | pF   | $V_{GS}=0\text{ V}$ , $V_{DS}=15\text{ V}$ , $f=1\text{ MHz}$                                       |
| Turn-on delay time           | $t_{d(on)}$  | -      | 26    | -     | ns   | $V_{DD}=15\text{ V}$ , $V_{GS}=10\text{ V}$ , $I_D=100\text{ A}$ ,<br>$R_{G,ext}=1.6\text{ }\Omega$ |
| Rise time                    | $t_r$        | -      | 14    | -     | ns   | $V_{DD}=15\text{ V}$ , $V_{GS}=10\text{ V}$ , $I_D=100\text{ A}$ ,<br>$R_{G,ext}=1.6\text{ }\Omega$ |
| Turn-off delay time          | $t_{d(off)}$ | -      | 103   | -     | ns   | $V_{DD}=15\text{ V}$ , $V_{GS}=10\text{ V}$ , $I_D=100\text{ A}$ ,<br>$R_{G,ext}=1.6\text{ }\Omega$ |
| Fall time                    | $t_f$        | -      | 22    | -     | ns   | $V_{DD}=15\text{ V}$ , $V_{GS}=10\text{ V}$ , $I_D=100\text{ A}$ ,<br>$R_{G,ext}=1.6\text{ }\Omega$ |

**Table 6 Gate charge characteristics<sup>1)</sup>**

| Parameter                    | Symbol        | Values |      |      | Unit | Note / Test Condition   |
|------------------------------|---------------|--------|------|------|------|---|
|                              |               | Min.   | Typ. | Max. |      |   |
| Gate to source charge        | $Q_{gs}$      | -      | 50   | -    | nC   | $V_{DD}=15\text{ V}$ , $I_D=100\text{ A}$ , $V_{GS}=0\text{ to }4.5\text{ V}$ |
| Gate charge at threshold     | $Q_{g(th)}$   | -      | 28   | -    | nC   | $V_{DD}=15\text{ V}$ , $I_D=100\text{ A}$ , $V_{GS}=0\text{ to }4.5\text{ V}$ |
| Gate to drain charge         | $Q_{gd}$      | -      | 24   | -    | nC   | $V_{DD}=15\text{ V}$ , $I_D=100\text{ A}$ , $V_{GS}=0\text{ to }4.5\text{ V}$ |
| Switching charge             | $Q_{sw}$      | -      | 46   | -    | nC   | $V_{DD}=15\text{ V}$ , $I_D=100\text{ A}$ , $V_{GS}=0\text{ to }4.5\text{ V}$ |
| Gate charge total            | $Q_g$         | -      | 110  | 146  | nC   | $V_{DD}=15\text{ V}$ , $I_D=100\text{ A}$ , $V_{GS}=0\text{ to }4.5\text{ V}$ |
| Gate plateau voltage         | $V_{plateau}$ | -      | 2.9  | -    | V    | $V_{DD}=15\text{ V}$ , $I_D=100\text{ A}$ , $V_{GS}=0\text{ to }4.5\text{ V}$ |
| Gate charge total            | $Q_g$         | -      | 227  | -    | nC   | $V_{DD}=15\text{ V}$ , $I_D=100\text{ A}$ , $V_{GS}=0\text{ to }10\text{ V}$  |
| Gate charge total, sync. FET | $Q_{g(sync)}$ | -      | 95   | -    | nC   | $V_{DS}=0.1\text{ V}$ , $V_{GS}=0\text{ to }4.5\text{ V}$                     |
| Output charge                | $Q_{oss}$     | -      | 148  | -    | nC   | $V_{DD}=15\text{ V}$ , $V_{GS}=0\text{ V}$                                    |

<sup>1)</sup> See "Gate charge waveforms" for parameter definition

**Table 7 Reverse diode**

| Parameter                        | Symbol        | Values |      |      | Unit | Note / Test Condition  |
|----------------------------------|---------------|--------|------|------|------|--|
|                                  |               | Min.   | Typ. | Max. |      |  |
| Diode continuous forward current | $I_S$         | -      | -    | 180  | A    | $T_C=25\text{ °C}$   |
| Diode pulse current              | $I_{S,pulse}$ | -      | -    | 1260 | A    | $T_C=25\text{ °C}$   |
| Diode forward voltage            | $V_{SD}$      | -      | 0.82 | 1    | V    | $V_{GS}=0\text{ V}, I_F=100\text{ A}, T_j=25\text{ °C}$      |
| Reverse recovery charge          | $Q_{rr}$      | -      | 135  | -    | nC   | $V_R=15\text{ V}, I_F=I_S, di_F/dt=400\text{ A}/\mu\text{s}$ |

### 4 Electrical characteristics diagrams

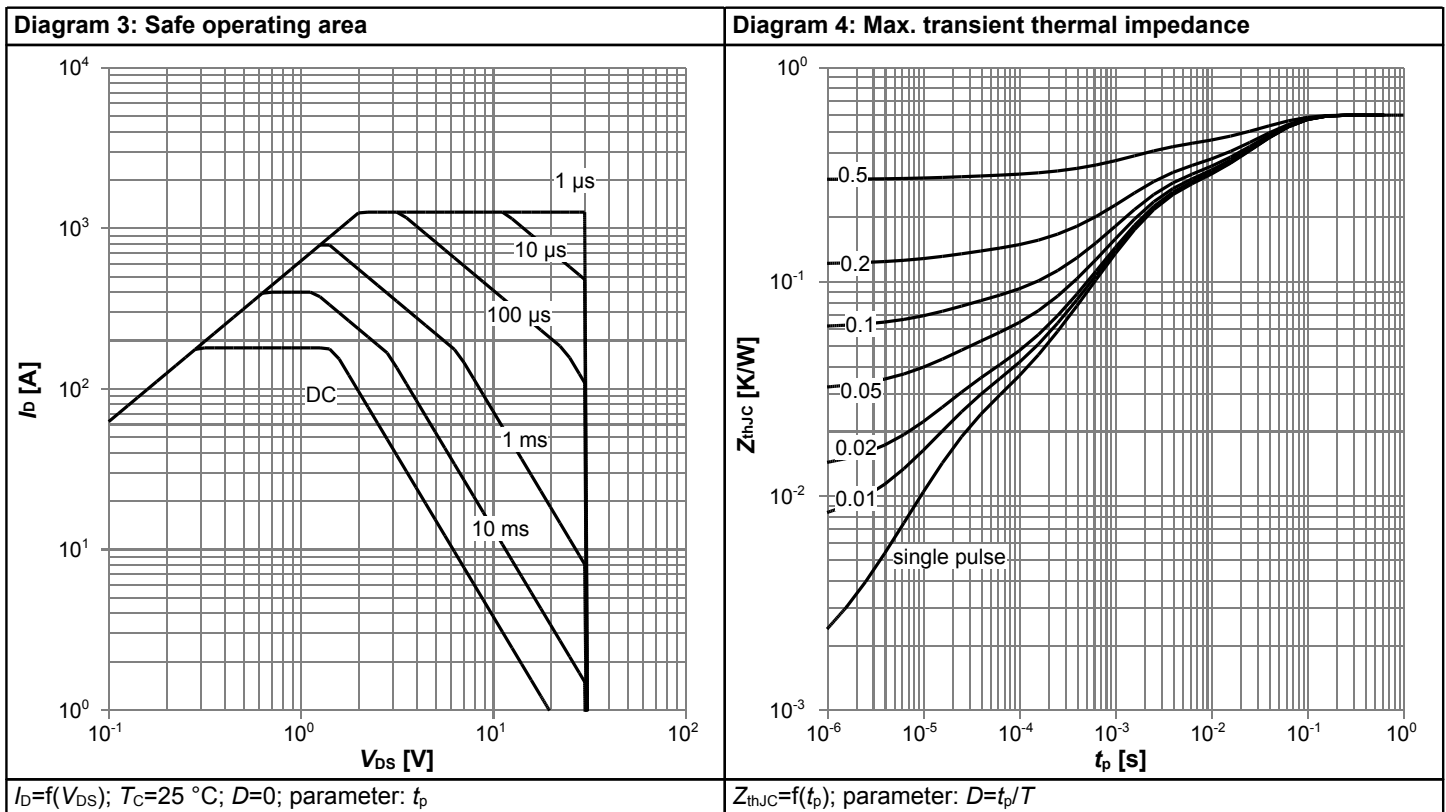
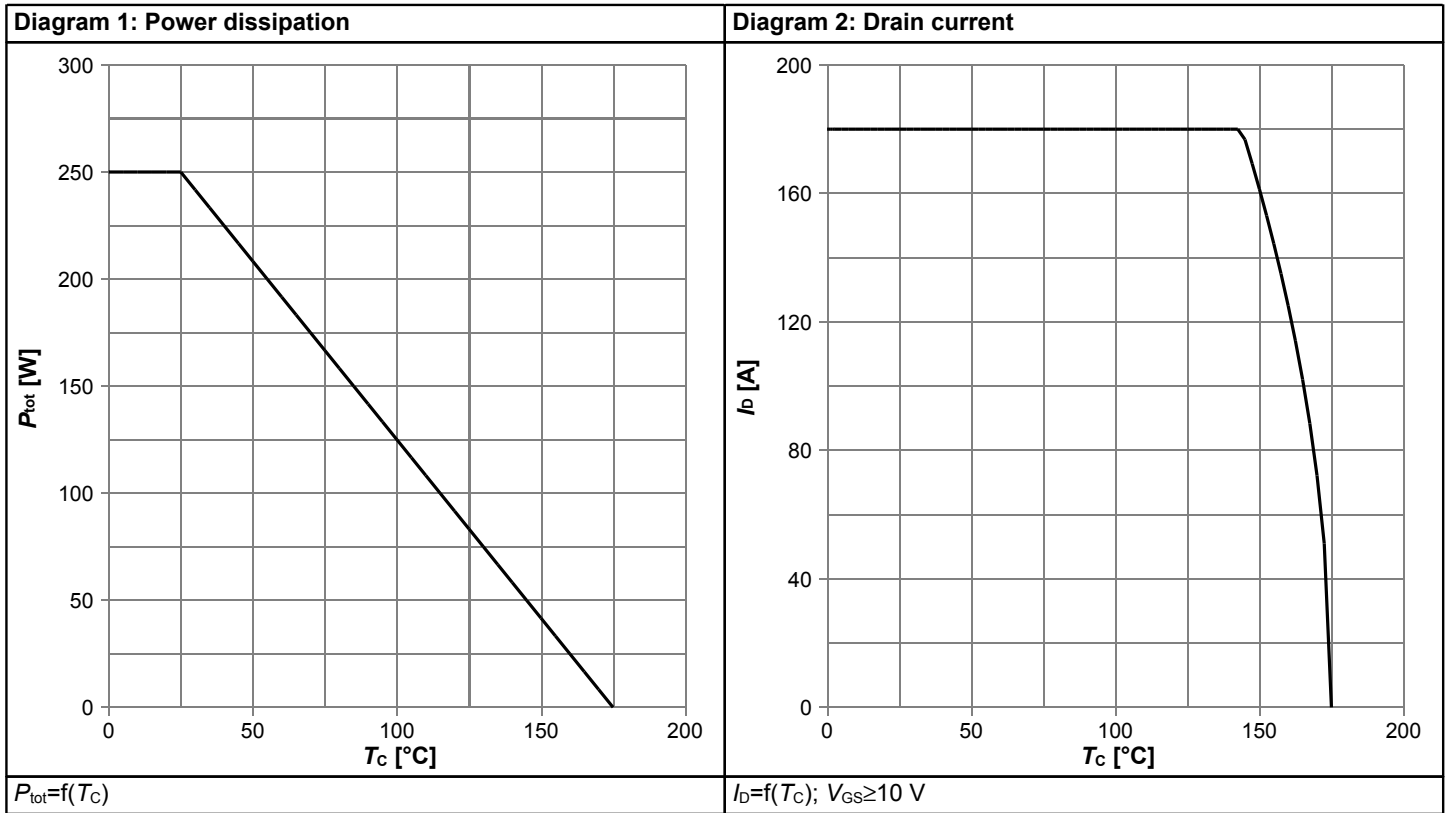
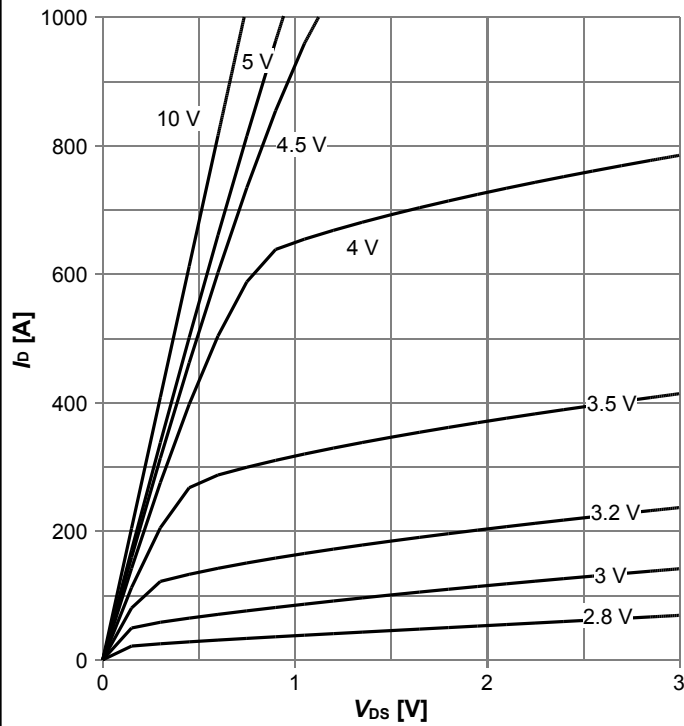
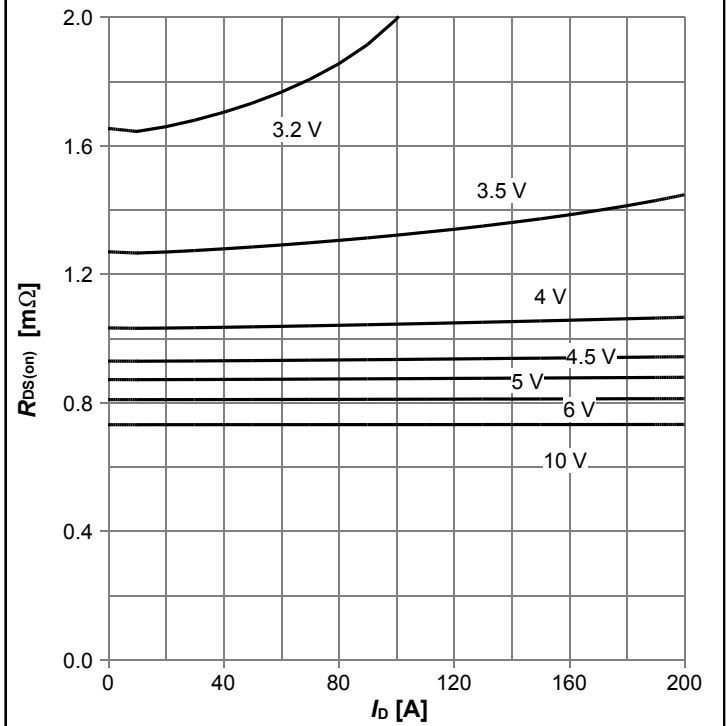


Diagram 5: Typ. output characteristics



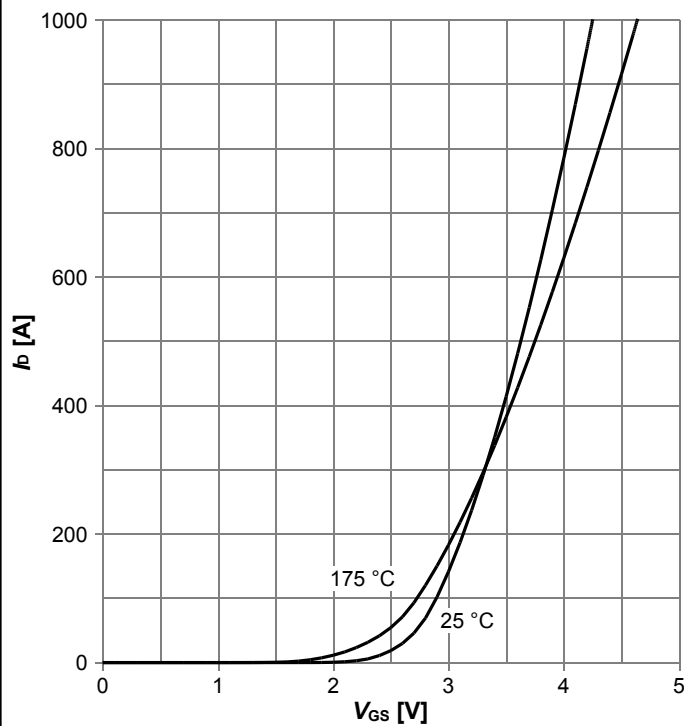
$I_D = f(V_{DS}); T_j = 25\text{ °C};$  parameter:  $V_{GS}$

Diagram 6: Typ. drain-source on resistance



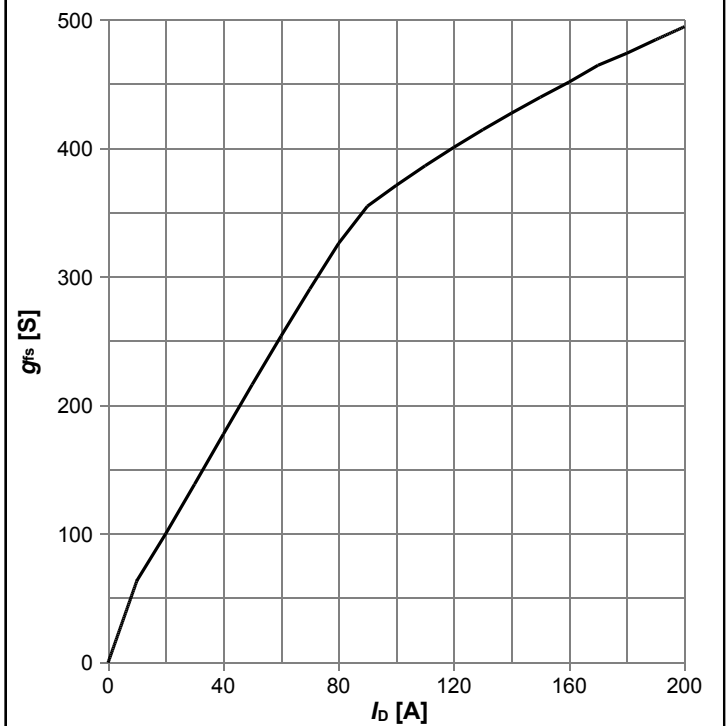
$R_{DS(on)} = f(I_D); T_j = 25\text{ °C};$  parameter:  $V_{GS}$

Diagram 7: Typ. transfer characteristics



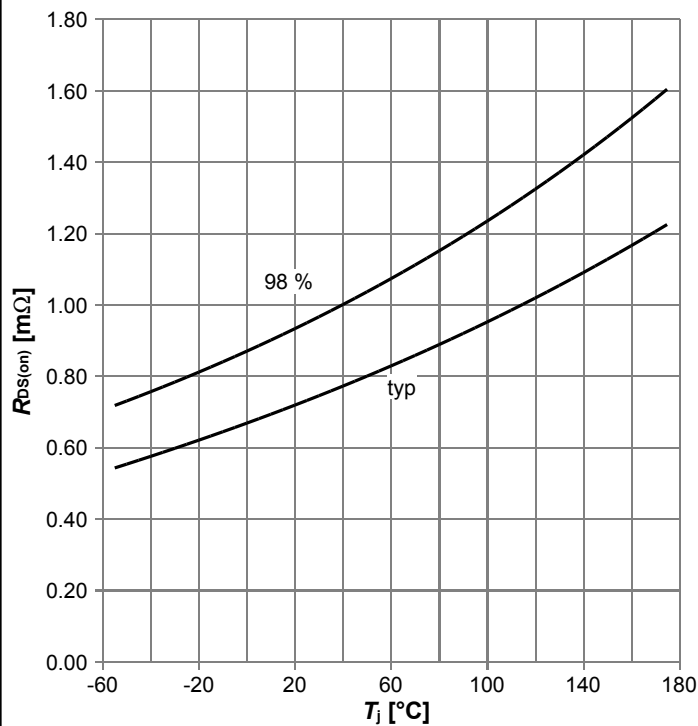
$I_D = f(V_{GS}); |V_{DS}| > 2|I_D|R_{DS(on)max};$  parameter:  $T_j$

Diagram 8: Typ. forward transconductance



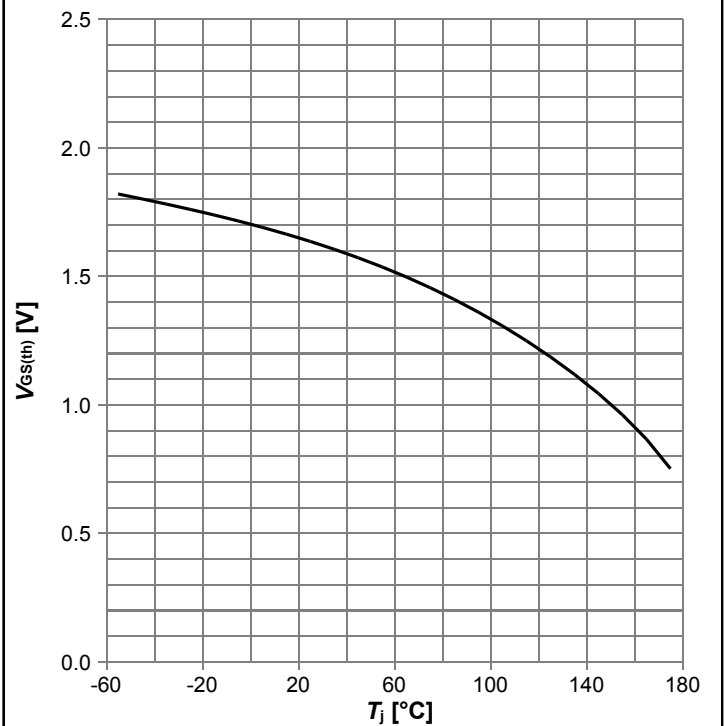
$g_{fs} = f(I_D); T_j = 25\text{ °C}$

Diagram 9: Drain-source on-state resistance



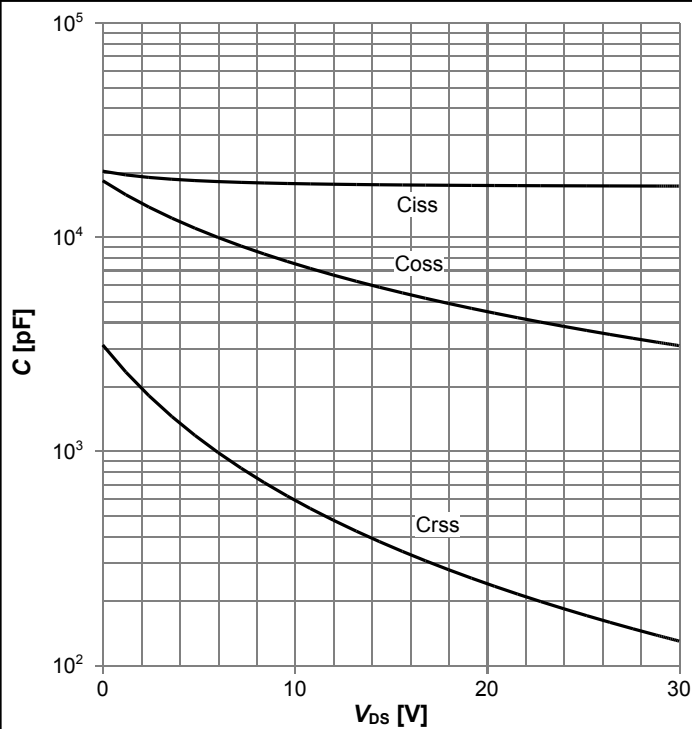
$R_{DS(on)}=f(T_j)$ ;  $I_D=100\text{ A}$ ;  $V_{GS}=10\text{ V}$

Diagram 10: Typ. gate threshold voltage



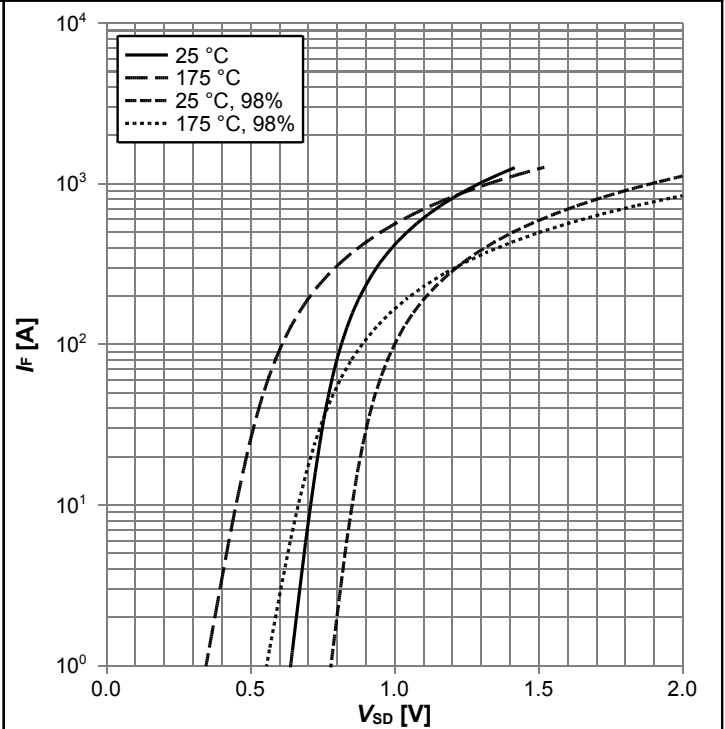
$V_{GS(th)}=f(T_j)$ ;  $V_{GS}=V_{DS}$ ;  $I_D=1\text{ mA}$

Diagram 11: Typ. capacitances



$C=f(V_{DS})$ ;  $V_{GS}=0\text{ V}$ ;  $f=1\text{ MHz}$

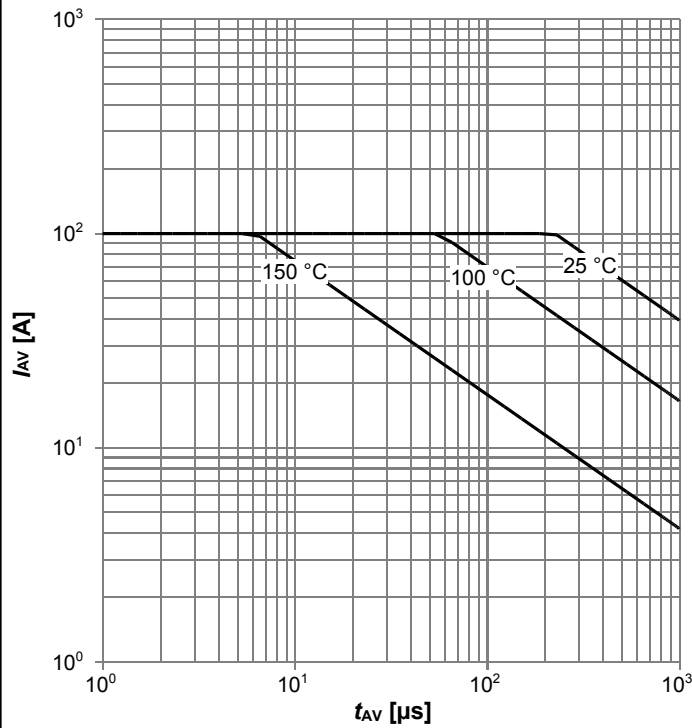
Diagram 12: Forward characteristics of reverse diode



$I_F=f(V_{SD})$ ; parameter:  $T_j$

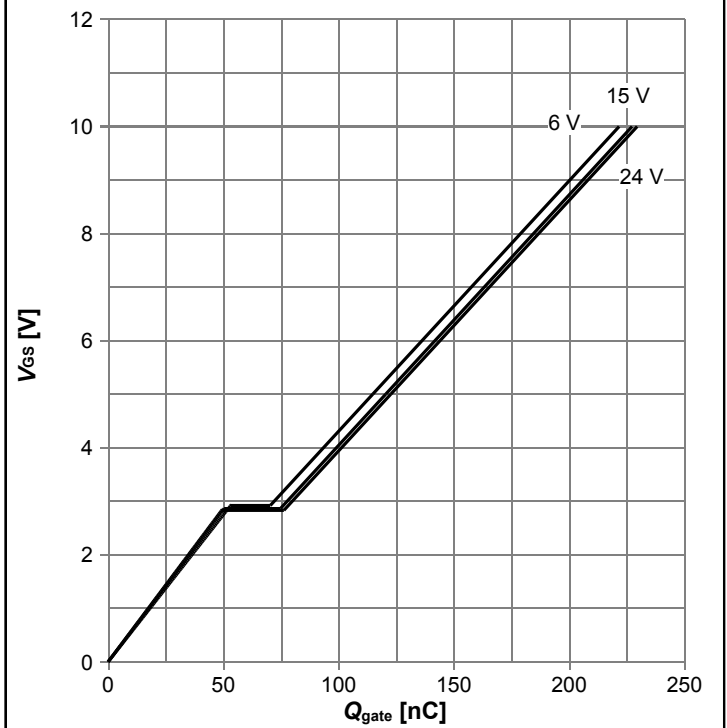


**Diagram 13: Avalanche characteristics**



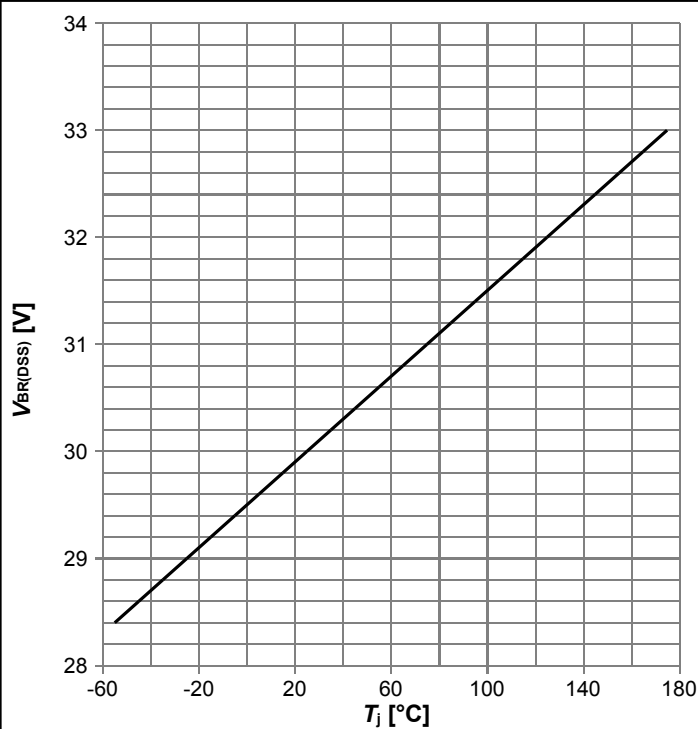
$I_{AS}=f(t_{AV}); R_{GS}=25 \Omega$ ; parameter:  $T_{j(start)}$

**Diagram 14: Typ. gate charge**



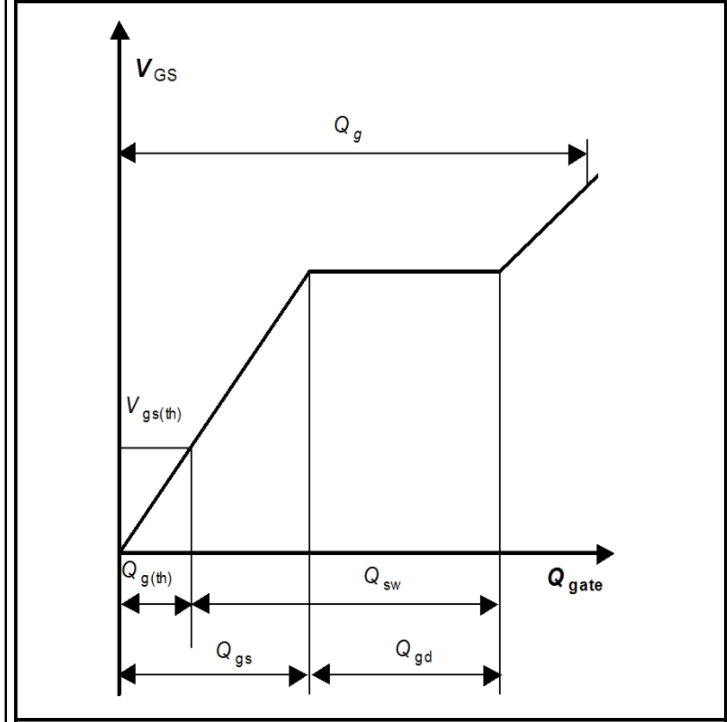
$V_{GS}=f(Q_{gate}); I_D=100 \text{ A pulsed}$ ; parameter:  $V_{DD}$

**Diagram 15: Drain-source breakdown voltage**

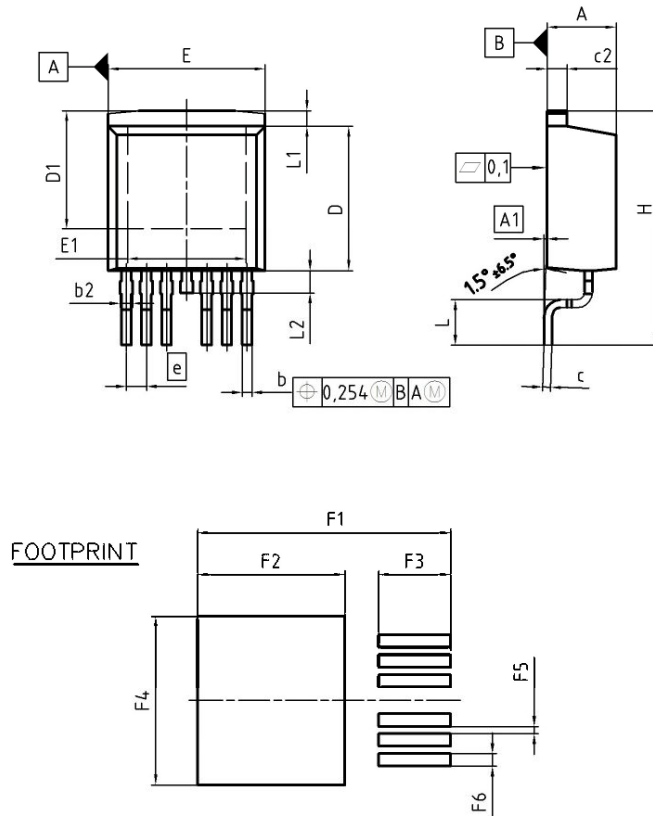


$V_{BR(DSS)}=f(T_j); I_D=1 \text{ mA}$

**Gate charge waveforms**



## 5 Package Outlines



| DIM | MILLIMETERS |       | INCHES |       |
|-----|-------------|-------|--------|-------|
|     | MIN         | MAX   | MIN    | MAX   |
| A   | 4.30        | 4.57  | 0.169  | 0.180 |
| A1  | 0.00        | 0.25  | 0.000  | 0.010 |
| b   | 0.50        | 0.70  | 0.020  | 0.028 |
| b2  | 0.50        | 1.00  | 0.020  | 0.039 |
| c   | 0.33        | 0.65  | 0.013  | 0.026 |
| c2  | 1.17        | 1.40  | 0.046  | 0.055 |
| D   | 8.51        | 9.45  | 0.335  | 0.372 |
| D1  | 6.90        | 7.90  | 0.272  | 0.311 |
| E   | 9.80        | 10.31 | 0.386  | 0.406 |
| E1  | 6.50        | 8.60  | 0.256  | 0.339 |
| e   | 1.27        |       | 0.050  |       |
| N   | 6           |       | 6      |       |
| H   | 14.61       | 15.88 | 0.575  | 0.625 |
| L   | 2.29        | 3.00  | 0.090  | 0.118 |
| L1  | 0.70        | 1.60  | 0.028  | 0.063 |
| L2  | 1.00        | 1.78  | 0.039  | 0.070 |
| F1  | 16.05       | 16.25 | 0.632  | 0.640 |
| F2  | 9.30        | 9.50  | 0.366  | 0.374 |
| F3  | 4.50        | 4.70  | 0.177  | 0.185 |
| F4  | 10.70       | 10.90 | 0.421  | 0.429 |
| F5  | 0.37        | 0.57  | 0.015  | 0.022 |
| F6  | 0.70        | 0.90  | 0.028  | 0.035 |

DOCUMENT NO.  
Z8B00134765

SCALE

EUROPEAN PROJECTION

ISSUE DATE  
05-11-2007

REVISION  
01

Figure 1 Outline PG-TO263-7, dimensions in mm/inches

## Revision History

IPB009N03L G

**Revision: 2016-04-21, Rev. 2.0**

Previous Revision

| Revision | Date       | Subjects (major changes since last revision) |
|----------|------------|--|
| 2.0      | 2016-04-21 | Release of final version                     |

### Trademarks of Infineon Technologies AG

AURIX™, C166™, CanPAK™, CIPOS™, CoolGaN™, CoolMOS™, CoolSET™, CoolSiC™, CORECONTROL™, CROSSAVE™, DAVE™, DI-POL™, DrBlade™, EasyPIM™, EconoBRIDGE™, EconoDUAL™, EconoPACK™, EconoPIM™, EiceDRIVER™, eupec™, FCOS™, HITFET™, HybridPACK™, Infineon™, ISOFACE™, IsoPACK™, i-Wafer™, MIPAQ™, ModSTACK™, my-d™, NovalithIC™, OmniTune™, OPTIGA™, OptiMOS™, ORIGA™, POWERCODE™, PRIMARION™, PrimePACK™, PrimeSTACK™, PROFET™, PRO-SIL™, RASIC™, REAL3™, ReverSave™, SatRIC™, SIEGET™, SIPMOS™, SmartLEWIS™, SOLID FLASH™, SPOC™, TEMPFET™, thinQ!™, TRENCHSTOP™, TriCore™.

Trademarks updated August 2015

### Other Trademarks

All referenced product or service names and trademarks are the property of their respective owners.

### We Listen to Your Comments

Any information within this document that you feel is wrong, unclear or missing at all? Your feedback will help us to continuously improve the quality of this document. Please send your proposal (including a reference to this document) to:

[erratum@infineon.com](mailto:erratum@infineon.com)

### Published by

**Infineon Technologies AG**

**81726 München, Germany**

**© 2016 Infineon Technologies AG**

**All Rights Reserved.**

### Legal Disclaimer

The information given in this document shall in no event be regarded as a guarantee of conditions or characteristics. With respect to any examples or hints given herein, any typical values stated herein and/or any information regarding the application of the device, Infineon Technologies hereby disclaims any and all warranties and liabilities of any kind, including without limitation, warranties of non-infringement of intellectual property rights of any third party.

### Information

For further information on technology, delivery terms and conditions and prices please contact your nearest Infineon Technologies Office ([www.infineon.com](http://www.infineon.com)).

### Warnings

Due to technical requirements, components may contain dangerous substances. For information on the types in question, please contact the nearest Infineon Technologies Office.

The Infineon Technologies component described in this Data Sheet may be used in life-support devices or systems and/or automotive, aviation and aerospace applications or systems only with the express written approval of Infineon Technologies, if a failure of such components can reasonably be expected to cause the failure of that life-support, automotive, aviation and aerospace device or system or to affect the safety or effectiveness of that device or system. Life support devices or systems are intended to be implanted in the human body or to support and/or maintain and sustain and/or protect human life. If they fail, it is reasonable to assume that the health of the user or other persons may be endangered.