

MOSFET

500V CoolMOS™ CE Power Transistor

CoolMOS™ is a revolutionary technology for high voltage power MOSFETs, designed according to the superjunction (SJ) principle and pioneered by Infineon Technologies. CoolMOS™ CE series combines the experience of the leading SJ MOSFET supplier with high class innovation while representing a cost appealing alternative compared to standard MOSFETs in target applications. The resulting devices provide all benefits of a fast switching SJ MOSFET while not sacrificing ease of use. Extremely low switching and conduction losses make switching applications even more efficient, more compact, lighter and cooler.

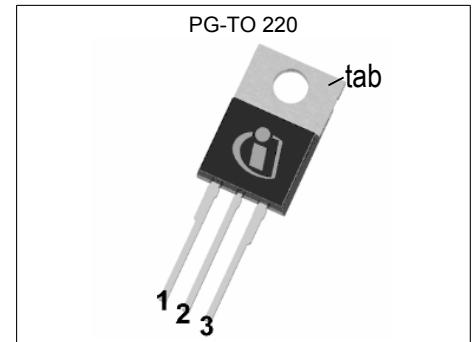

Features

- Extremely low losses due to very low FOM $R_{DS(on)} \cdot Q_g$ and E_{oss}
- Very high commutation ruggedness
- Easy to use/drive
- Pb-free plating, Halogen free mold compound
- Qualified for industrial grade applications according to JEDEC (J-STD20 and JESD22)

Applications

PFC stages, hard switching PWM stages and resonant switching PWM stages for e.g. PC Silverbox, LCD & PDP TV and Lighting.

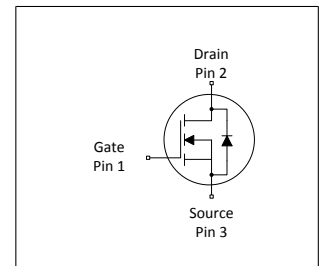

Table 1 Key Performance Parameters

Parameter	Value	Unit
$V_{DS} @ T_{j,max}$	550	V
$R_{DS(on),max}$	0.38	Ω
I_D	14.1	A
$Q_{g,typ}$	24.8	nC
$I_{D,pulse}$	32.4	A
$E_{oss} @ 400V$	2.54	μJ

Type / Ordering Code	Package	Marking	Related Links
IPP50R380CE	PG-TO 220	5R380CE	see Appendix A

Table of Contents

Description	1
Maximum ratings	3
Thermal characteristics	3
Electrical characteristics	4
Electrical characteristics diagrams	6
Test Circuits	10
Package Outlines	11
Appendix A	12
Revision History	13
Trademarks	13
Disclaimer	13

1 Maximum ratings

at $T_j = 25^\circ\text{C}$, unless otherwise specified

Table 2 Maximum ratings

Parameter	Symbol	Values			Unit	Note / Test Condition
		Min.	Typ.	Max.		
Continuous drain current ¹⁾	I_D	-	-	14.1 8.9	A	$T_C = 25^\circ\text{C}$ $T_C = 100^\circ\text{C}$
Pulsed drain current ²⁾	$I_{D,pulse}$	-	-	32.4	A	$T_C=25^\circ\text{C}$
Avalanche energy, single pulse	E_{AS}	-	-	173	mJ	$I_D=4\text{A}; V_{DD} = 50\text{V}$
Avalanche energy, repetitive	E_{AR}	-	-	0.26	mJ	$I_D=4\text{A}; V_{DD} = 50\text{V}$
Avalanche current, repetitive	I_{AR}	-	-	4.0	A	-
MOSFET dv/dt ruggedness	dv/dt	-	-	50	V/ns	$V_{DS} = 0\dots 400\text{V}$
Gate source voltage	V_{GS}	-20 -30	-	20 30	V	static; AC ($f > 1\text{ Hz}$)
Power dissipation (non FullPAK) TO-220	P_{tot}	-	-	98	W	$T_C=25^\circ\text{C}$
Operating and storage temperature	T_j, T_{stg}	-55	-	150	$^\circ\text{C}$	-
Mounting torque (non FullPAK) TO-220	-	-	-	60	Ncm	M3 and M3.5 screws
Continuous diode forward current	I_S	-	-	10	A	$T_C=25^\circ\text{C}$
Diode pulse current ²⁾	$I_{S,pulse}$	-	-	32.4	A	$T_C = 25^\circ\text{C}$
Reverse diode dv/dt ³⁾	dv/dt	-	-	15	V/ns	$V_{DS} = 0\dots 400\text{V}, I_{SD} \leq I_S, T_j=25^\circ\text{C}, t_{cond} < 2\mu\text{s}$
Maximum diode commutation speed ³⁾	di_f/dt	-	-	500	A/ μs	$V_{DS} = 0\dots 400\text{V}, I_{SD} \leq I_S, T_j=25^\circ\text{C}, t_{cond} < 2\mu\text{s}$

2 Thermal characteristics

Table 3 Thermal characteristics (non FullPAK) TO-220

Parameter	Symbol	Values			Unit	Note / Test Condition
		Min.	Typ.	Max.		
Thermal resistance, junction - case	R_{thJC}	-	-	1.27	$^\circ\text{C/W}$	-
Thermal resistance, junction - ambient	R_{thJA}	-	-	62	$^\circ\text{C/W}$	loaded
Soldering temperature, wavesoldering only allowed at leads	T_{sold}	-	-	260	$^\circ\text{C}$	1.6mm (0.063 in.) from case for 10s

¹⁾ Limited by $T_{j,max} < 150^\circ\text{C}$, Maximum Duty Cycle $D = 0.5$

²⁾ Pulse width t_p limited by $T_{j,max}$

³⁾ $V_{DClink}=400\text{V}; V_{DS,peak} < V_{(BR)DSS}$; identical low side and high side switch with identical R_G

3 Electrical characteristics

Table 4 Static characteristics

Parameter	Symbol	Values			Unit	Note / Test Condition
		Min.	Typ.	Max.		
Drain-source breakdown voltage	$V_{(BR)DSS}$	500	-	-	V	$V_{GS}=0V, I_D=1mA$
Gate threshold voltage	$V_{(GS)th}$	2.50	3	3.50	V	$V_{DS}=V_{GS}, I_D=0.26mA$
Zero gate voltage drain current	I_{DSS}	-	-	1	μA	$V_{DS}=500V, V_{GS}=0V, T_j=25^\circ C$ $V_{DS}=500V, V_{GS}=0V, T_j=150^\circ C$
Gate-source leakage current	I_{GSS}	-	-	100	nA	$V_{GS}=20V, V_{DS}=0V$
Drain-source on-state resistance	$R_{DS(on)}$	-	0.35	0.38	Ω	$V_{GS}=13V, I_D=3.2A, T_j=25^\circ C$ $V_{GS}=13V, I_D=3.2A, T_j=150^\circ C$
Gate resistance	R_G	-	3	-	Ω	$f=1\text{ MHz}, \text{open drain}$

Table 5 Dynamic characteristics

Parameter	Symbol	Values			Unit	Note / Test Condition
		Min.	Typ.	Max.		
Input capacitance	C_{iss}	-	584	-	pF	$V_{GS}=0V, V_{DS}=100V, f=1MHz$
Output capacitance	C_{oss}	-	40	-	pF	$V_{GS}=0V, V_{DS}=100V, f=1MHz$
Effective output capacitance, energy related ¹⁾	$C_{o(er)}$	-	32	-	pF	$V_{GS}=0V, V_{DS}=0...400V$
Effective output capacitance, time related ²⁾	$C_{o(tr)}$	-	133	-	pF	$I_D=\text{constant}, V_{GS}=0V, V_{DS}=0...400V$
Turn-on delay time	$t_{d(on)}$	-	7.2	-	ns	$V_{DD}=400V, V_{GS}=13V, I_D=3.9A,$ $R_G=3.4\Omega$
Rise time	t_r	-	5.6	-	ns	$V_{DD}=400V, V_{GS}=13V, I_D=3.9A,$ $R_G=3.4\Omega$
Turn-off delay time	$t_{d(off)}$	-	35	-	ns	$V_{DD}=400V, V_{GS}=13V, I_D=3.9A,$ $R_G=3.4\Omega$
Fall time	t_f	-	8.6	-	ns	$V_{DD}=400V, V_{GS}=13V, I_D=3.9A,$ $R_G=3.4\Omega$

Table 6 Gate charge characteristics

Parameter	Symbol	Values			Unit	Note / Test Condition
		Min.	Typ.	Max.		
Gate to source charge	Q_{gs}	-	3.1	-	nC	$V_{DD}=400V, I_D=3.9A, V_{GS}=0\text{ to }10V$
Gate to drain charge	Q_{gd}	-	13.1	-	nC	$V_{DD}=400V, I_D=3.9A, V_{GS}=0\text{ to }10V$
Gate charge total	Q_g	-	24.8	-	nC	$V_{DD}=400V, I_D=3.9A, V_{GS}=0\text{ to }10V$
Gate plateau voltage	$V_{plateau}$	-	5.3	-	V	$V_{DD}=400V, I_D=3.9A, V_{GS}=0\text{ to }10V$

¹⁾ $C_{o(er)}$ is a fixed capacitance that gives the same stored energy as C_{oss} while V_{DS} is rising from 0 to 80% $V_{(BR)DSS}$

²⁾ $C_{o(tr)}$ is a fixed capacitance that gives the same charging time as C_{oss} while V_{DS} is rising from 0 to 80% $V_{(BR)DSS}$

Table 7 Reverse diode characteristics

Parameter	Symbol	Values			Unit	Note / Test Condition
		Min.	Typ.	Max.		
Diode forward voltage	V_{SD}	-	0.85	-	V	$V_{GS}=0V, I_F=3.9A, T_i=25^{\circ}C$
Reverse recovery time	t_{rr}	-	207	-	ns	$V_R=400V, I_F=3.9A, di_F/dt=100A/\mu s$
Reverse recovery charge	Q_{rr}	-	1.7	-	μC	$V_R=400V, I_F=3.9A, di_F/dt=100A/\mu s$
Peak reverse recovery current	I_{rrm}	-	15.5	-	A	$V_R=400V, I_F=3.9A, di_F/dt=100A/\mu s$

4 Electrical characteristics diagrams

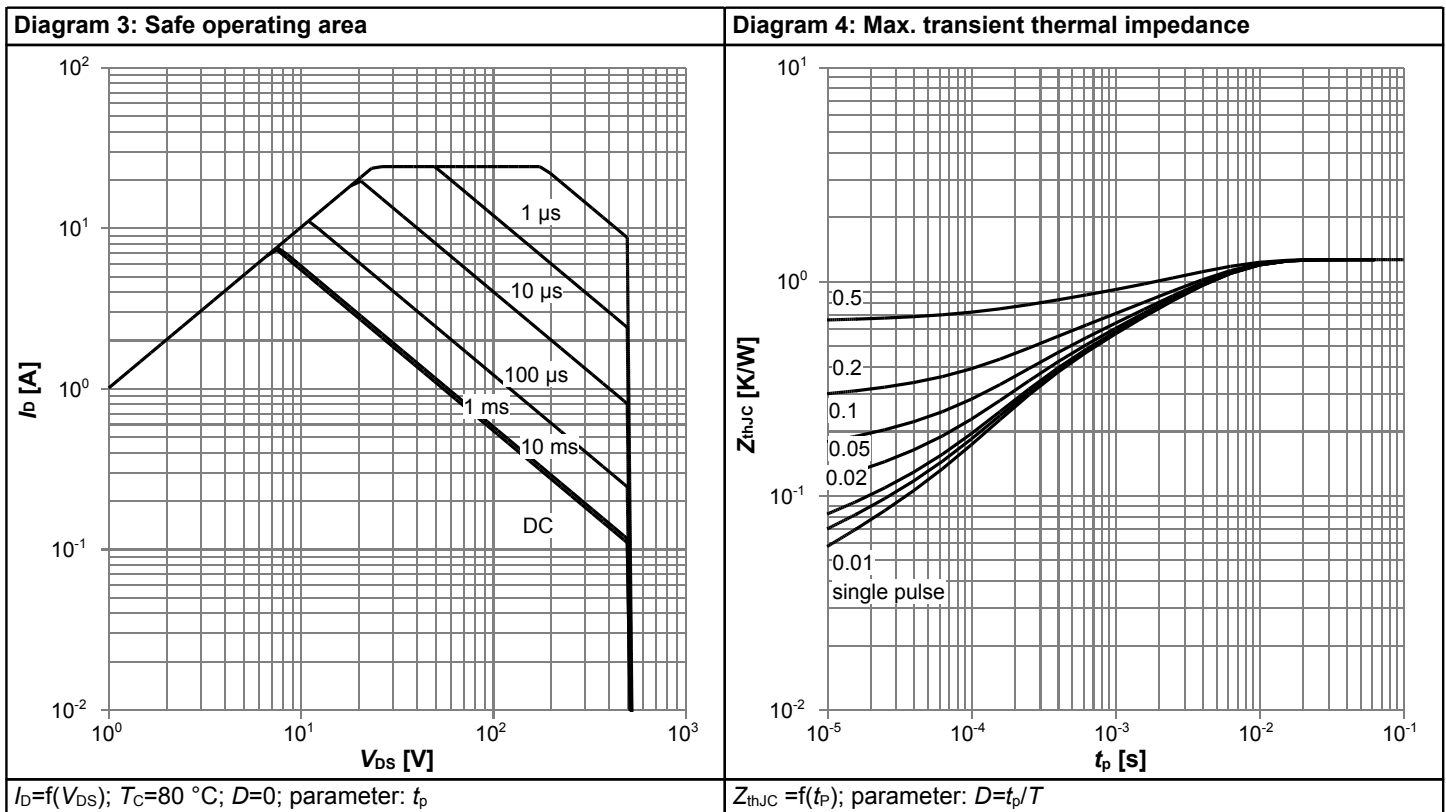
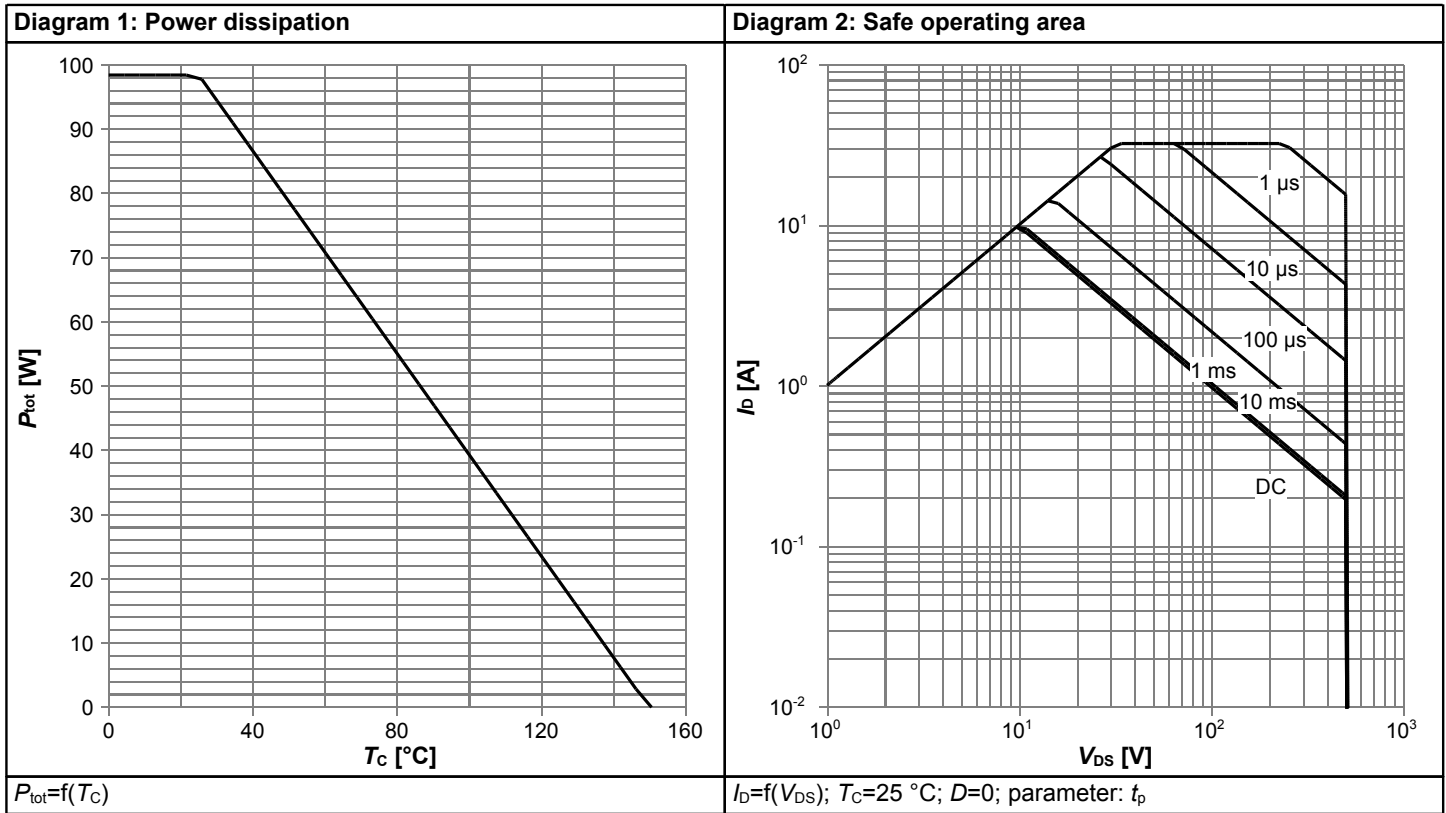

500V CoolMOS™ CE Power Transistor

IPP50R380CE

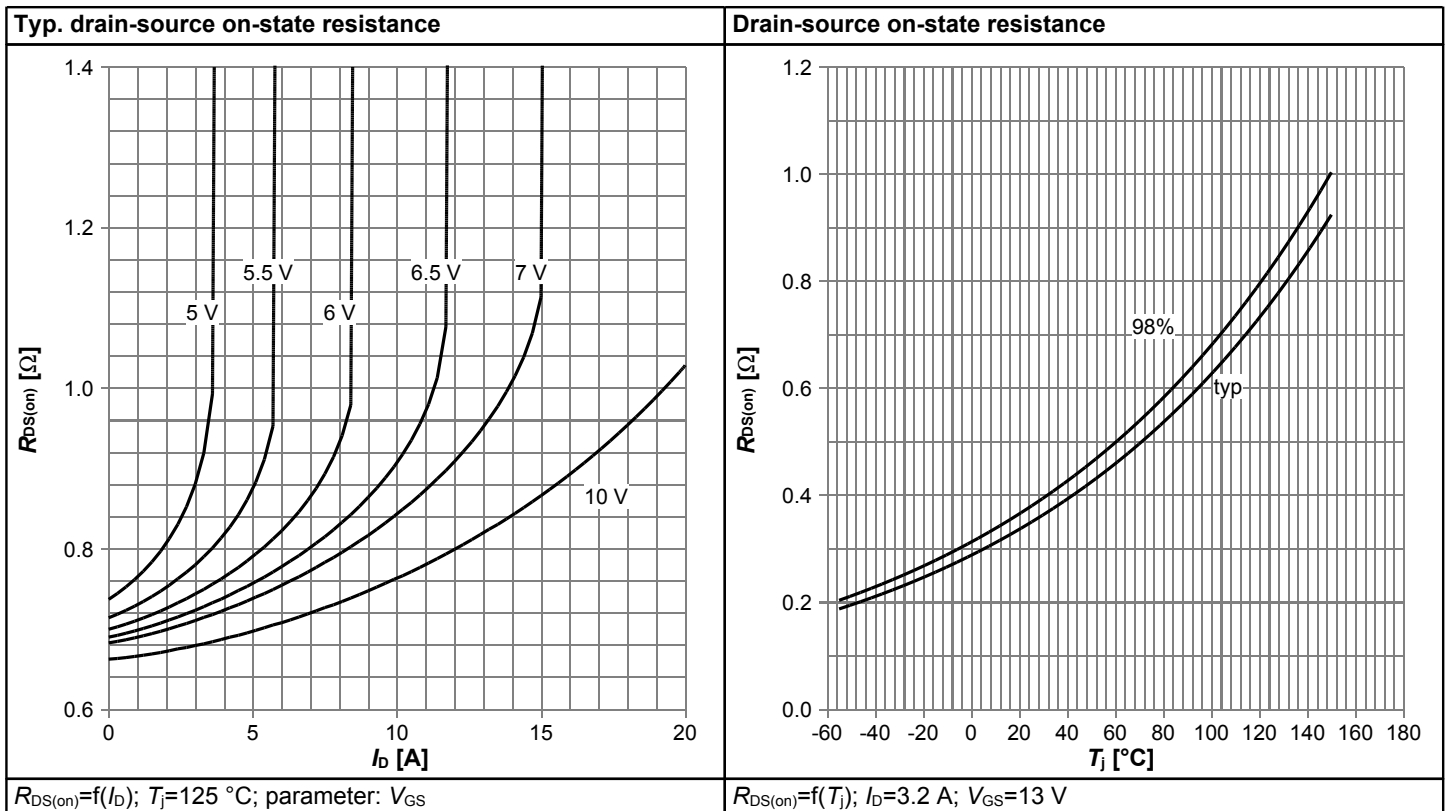
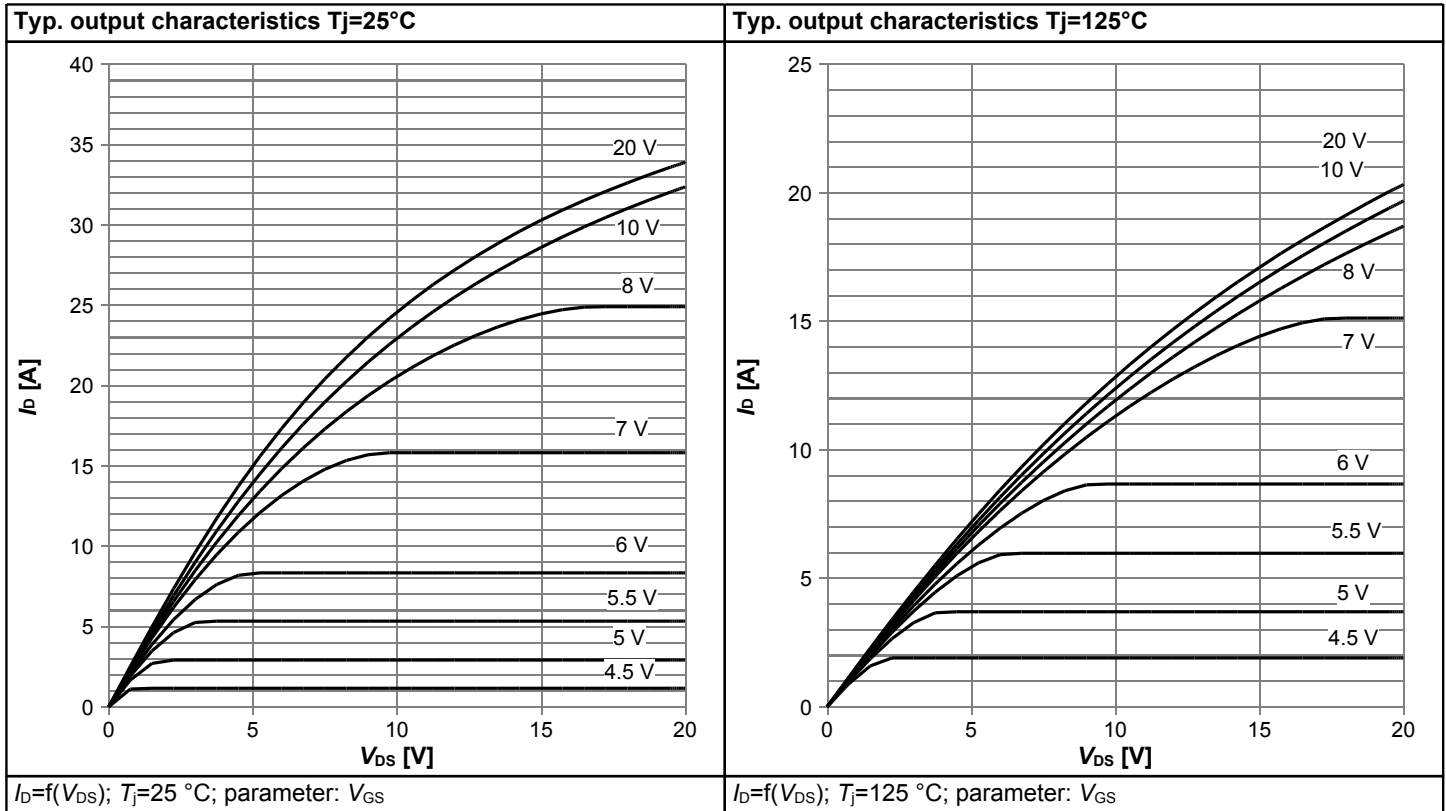

Typ. transfer characteristics

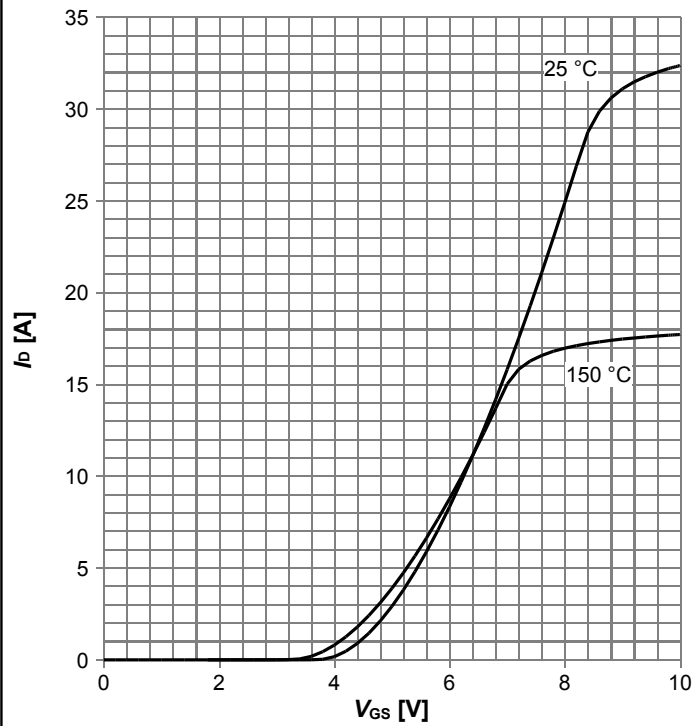

$I_D=f(V_{GS}); V_{DS}=20V$; parameter: T_j

Typ. gate charge

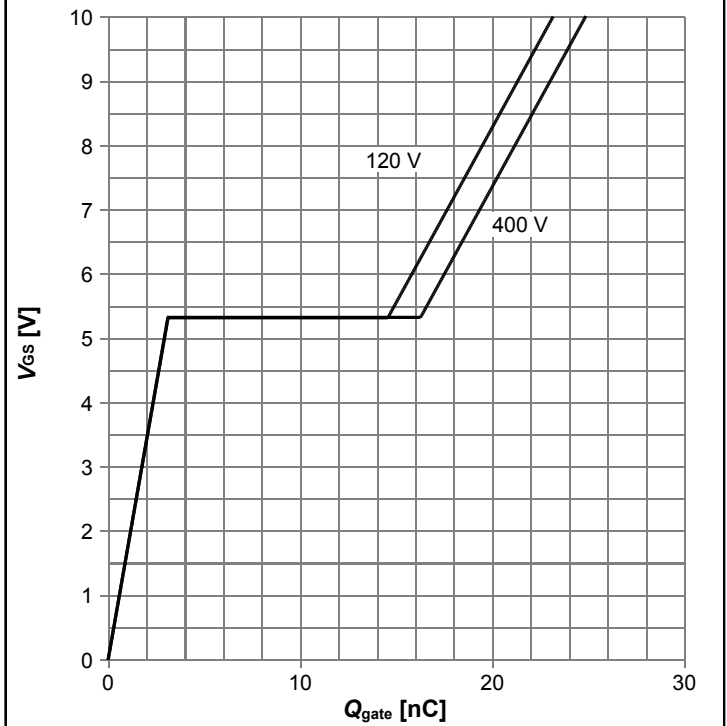

$V_{GS}=f(Q_{gate}); I_D=3.9$ A pulsed; parameter: V_{DD}

Avalanche energy

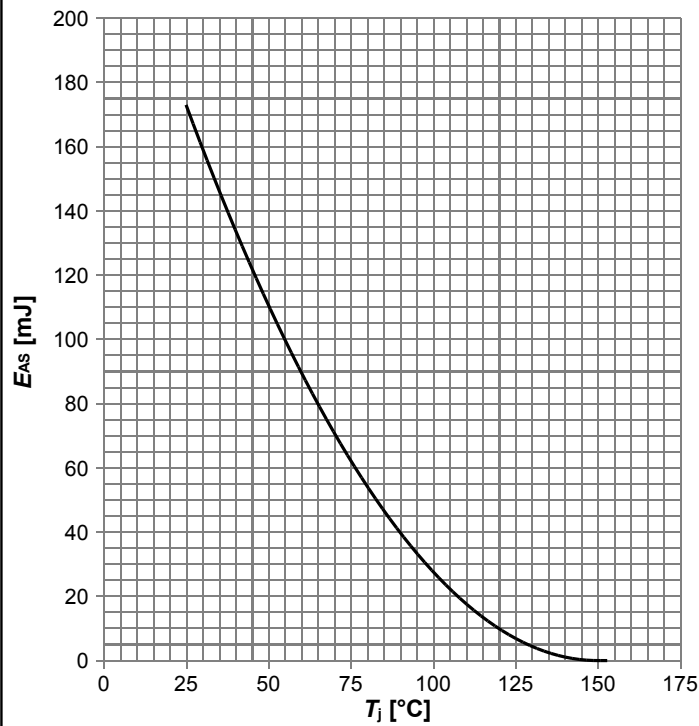

$E_{AS}=f(T_j); I_D=4$ A; $V_{DD}=50$ V

Drain-source breakdown voltage

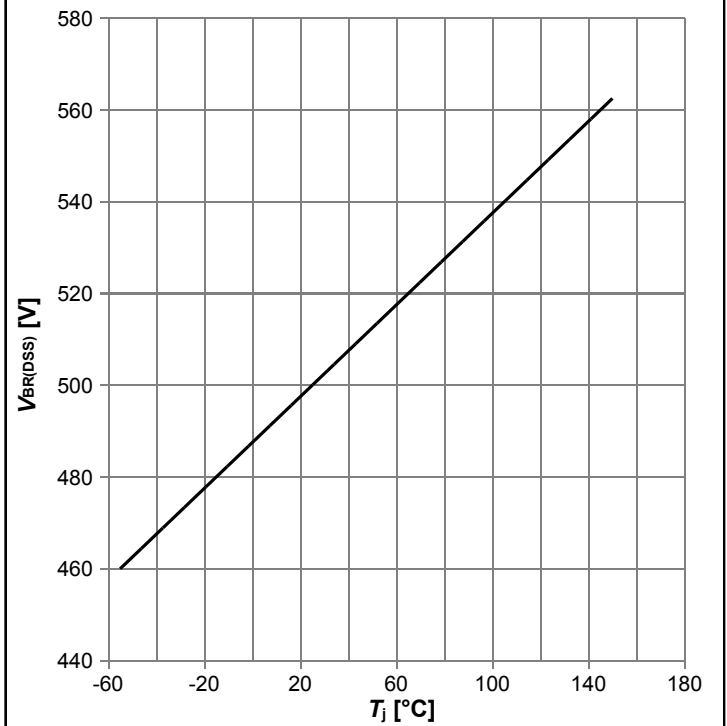

$V_{BR(DSS)}=f(T_j); I_D=1$ mA

500V CoolMOS™ CE Power Transistor
IPP50R380CE

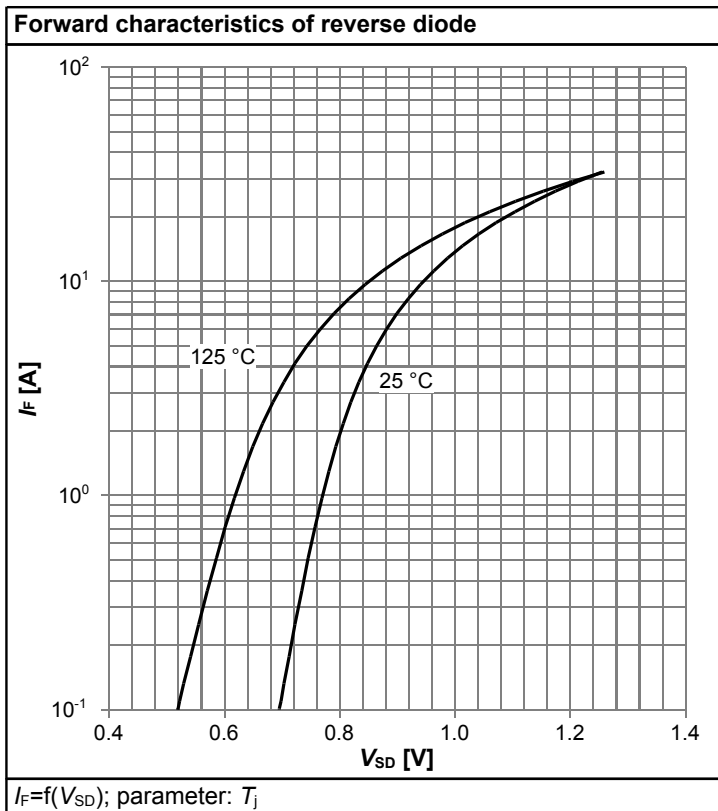
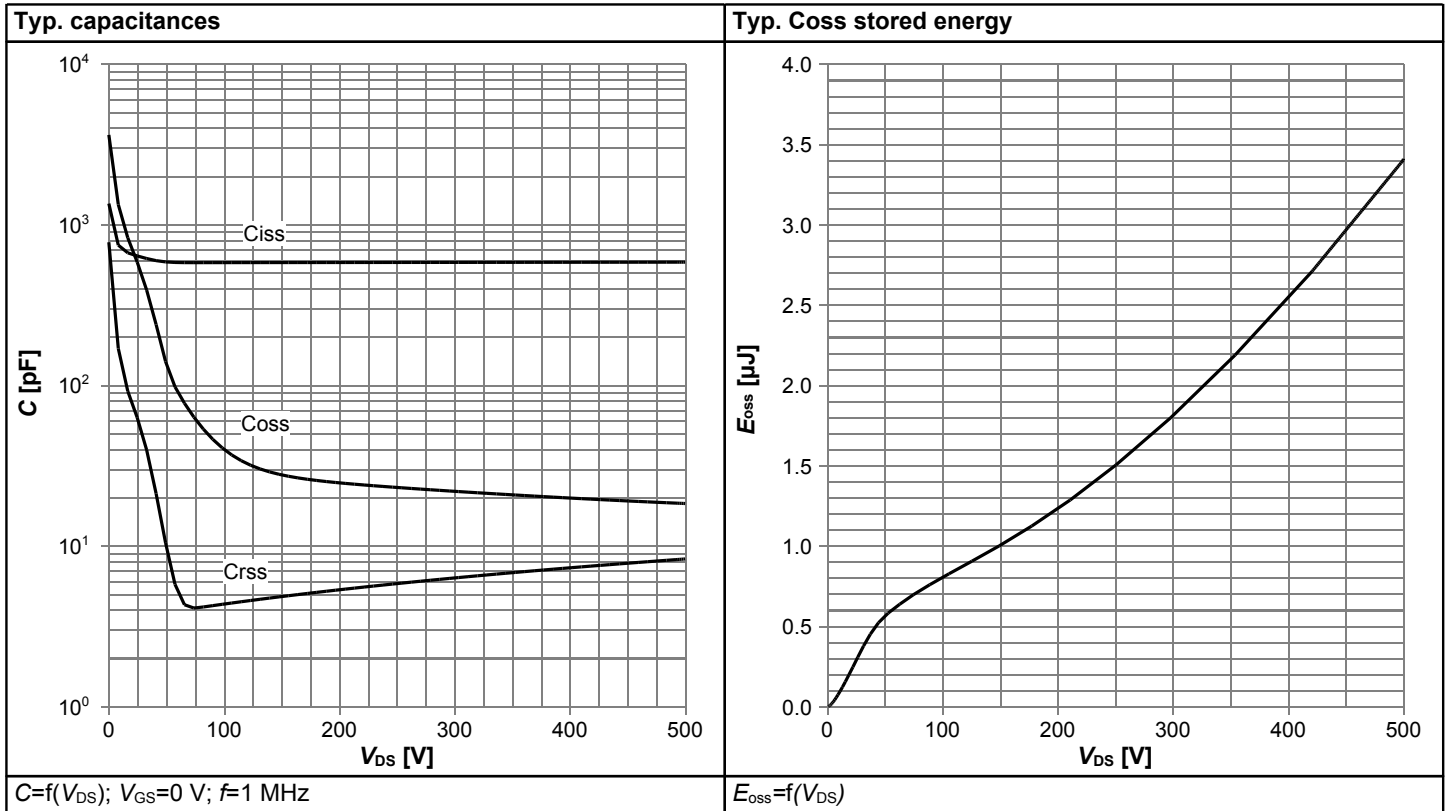

5 Test Circuits

Table 8 Diode characteristics

Test circuit for diode characteristics	Diode recovery waveform
<p>$R_{g1} = R_{g2}$</p>	<p>$t_{tr} = t_F + t_S$ $Q_{tr} = Q_F + Q_S$</p>

Table 9 Switching times

Switching times test circuit for inductive load	Switching times waveform

Table 10 Unclamped inductive load

Unclamped inductive load test circuit	Unclamped inductive waveform

6 Package Outlines

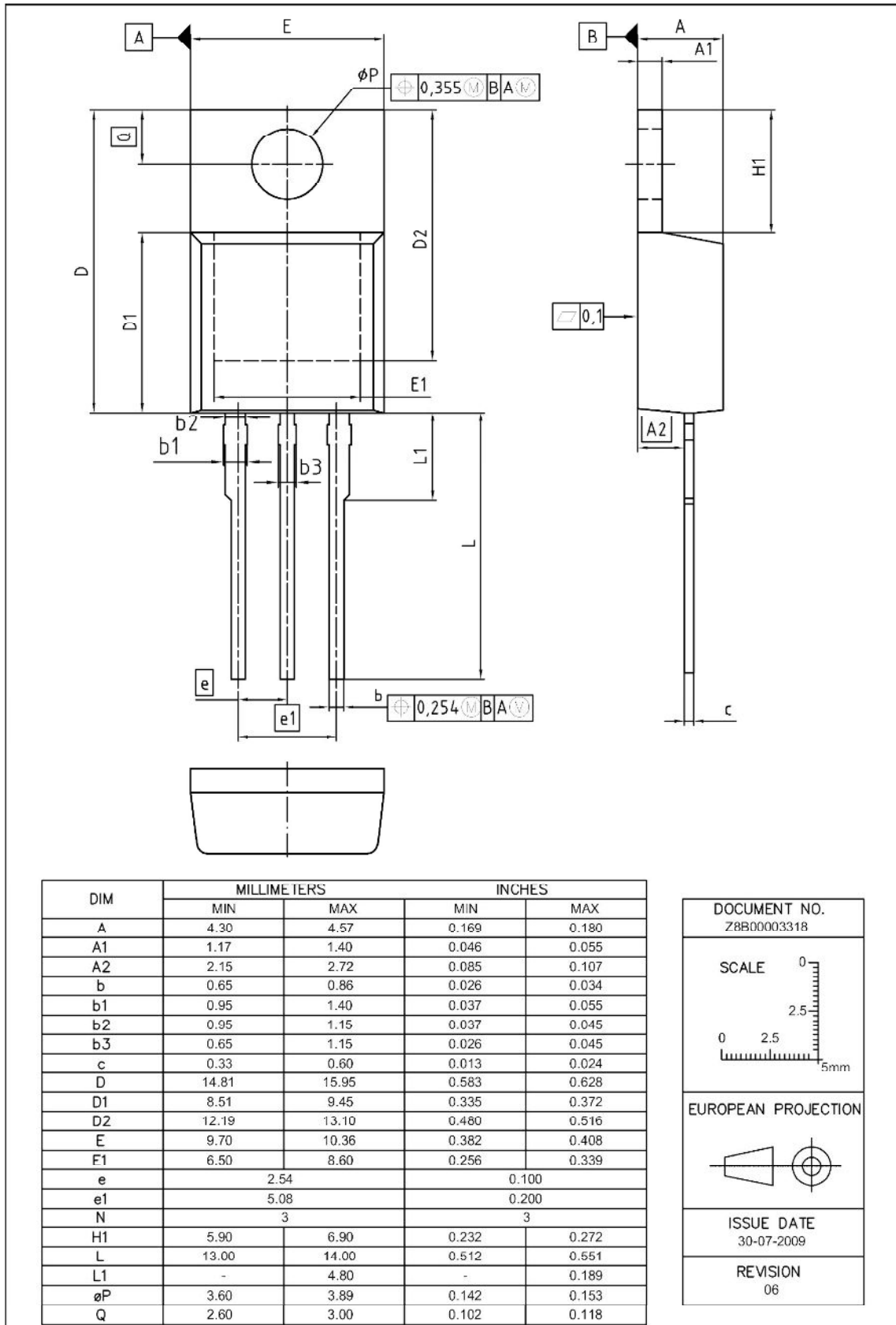

Figure 1 Outline PG-TO 220, dimensions in mm/inches

7 Appendix A

Table 11 Related Links

- **IFX CoolMOS Webpage:** www.infineon.com
- **IFX Design tools:** www.infineon.com

Revision History

IPP50R380CE

Revision: 2016-06-13, Rev. 2.2

Previous Revision

Revision	Date	Subjects (major changes since last revision)
2.0	2012-08-24	Release of final version
2.1	2014-06-06	Removal of TO-220FP
2.2	2016-06-13	Updated ID rating, Zth, SOA and Pd curves

Trademarks of Infineon Technologies AG

AURIX™, C166™, CanPAK™, CIPOS™, CoolGaN™, CoolMOS™, CoolSET™, CoolSiC™, CORECONTROL™, CROSSAVE™, DAVE™, DI-POL™, DrBlade™, EasyPIM™, EconoBRIDGE™, EconoDUAL™, EconoPACK™, EconoPIM™, EiceDRIVER™, eupec™, FCOS™, HITFET™, HybridPACK™, Infineon™, ISOFACE™, IsoPACK™, i-Wafer™, MIPAQ™, ModSTACK™, my-d™, NovalithIC™, OmniTune™, OPTIGA™, OptiMOS™, ORIGA™, POWERCODE™, PRIMARION™, PrimePACK™, PrimeSTACK™, PROFET™, PRO-SIL™, RASIC™, REAL3™, ReverSave™, SatRIC™, SIEGET™, SiPMOS™, SmartLEWIS™, SOLID FLASH™, SPOC™, TEMPFET™, thinQ!™, TRENCHSTOP™, TriCore™.

Trademarks updated August 2015

Other Trademarks

All referenced product or service names and trademarks are the property of their respective owners.

We Listen to Your Comments

Any information within this document that you feel is wrong, unclear or missing at all? Your feedback will help us to continuously improve the quality of this document. Please send your proposal (including a reference to this document) to: erratum@infineon.com

Published by
Infineon Technologies AG
81726 München, Germany
© 2016 Infineon Technologies AG
All Rights Reserved.

Legal Disclaimer

The information given in this document shall in no event be regarded as a guarantee of conditions or characteristics. With respect to any examples or hints given herein, any typical values stated herein and/or any information regarding the application of the device, Infineon Technologies hereby disclaims any and all warranties and liabilities of any kind, including without limitation, warranties of non-infringement of intellectual property rights of any third party.

Information

For further information on technology, delivery terms and conditions and prices please contact your nearest Infineon Technologies Office (www.infineon.com).

Warnings

Due to technical requirements, components may contain dangerous substances. For information on the types in question, please contact the nearest Infineon Technologies Office.

The Infineon Technologies component described in this Data Sheet may be used in life-support devices or systems and/or automotive, aviation and aerospace applications or systems only with the express written approval of Infineon Technologies, if a failure of such components can reasonably be expected to cause the failure of that life-support, automotive, aviation and aerospace device or system or to affect the safety or effectiveness of that device or system. Life support devices or systems are intended to be implanted in the human body or to support and/or maintain and sustain and/or protect human life. If they fail, it is reasonable to assume that the health of the user or other persons may be endangered.