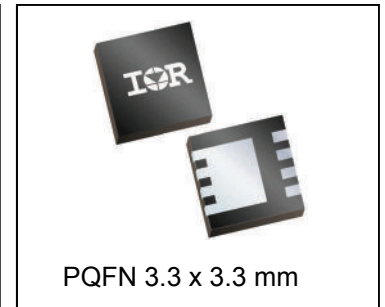
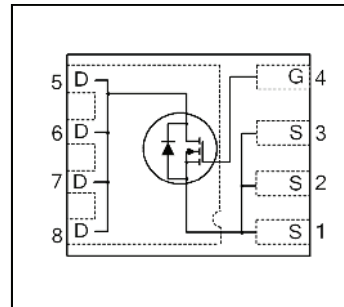


HEXFET® Power MOSFET

$V_{DSS}$	25	V
$R_{DS(on) \max}$ (@ $V_{GS} = 10V$ )	3.4	mΩ
(@ $V_{GS} = 4.5V$ )	4.6	
$Qg$ (typical)	9.7	nC
$I_D$ (@ $T_C$ (Bottom) = 25°C)	40⑦	A



### Applications

- Control MOSFET for synchronous buck converter

### Features

Low Charge (typical 9.7nC)
Low $R_{DS(on)}$ (<3.4mΩ)
Low Thermal Resistance to PCB (<4.3°C/W)
Low Profile (<0.9mm)
Industry-Standard Pinout
Compatible with Existing Surface Mount Techniques
RoHS Compliant, Halogen-Free
MSL1, Industrial Qualification

results in



### Benefits

Low Switching Losses
Lower Conduction Losses
Enable better Thermal Dissipation
Increased Power Density
Multi-Vendor Compatibility
Easier Manufacturing
Environmentally Friendlier
Increased Reliability

Base part number	Package Type	Standard Pack		Orderable Part Number
		Form	Quantity	
IRFHM4231PbF	PQFN 3.3mm x 3.3mm	Tape and Reel	4000	IRFHM4231TRPbF

### Absolute Maximum Ratings

	Parameter	Max.	Units
$V_{GS}$	Gate-to-Source Voltage	± 20	V
$I_D$ @ $T_A = 25^\circ C$	Continuous Drain Current, $V_{GS}$ @ 10V	22	A
$I_D$ @ $T_{C(Bottom)} = 25^\circ C$	Continuous Drain Current, $V_{GS}$ @ 10V	72⑥⑦	
$I_D$ @ $T_{C(Bottom)} = 100^\circ C$	Continuous Drain Current, $V_{GS}$ @ 10V	46⑥	
$I_D$ @ $T_C = 25^\circ C$	Continuous Drain Current, $V_{GS}$ @ 10V (Source Bonding Technology Limited)	40⑦	
$I_{DM}$	Pulsed Drain Current ①	288	
$P_D$ @ $T_A = 25^\circ C$	Power Dissipation ⑤	2.7	W
$P_D$ @ $T_{C(Bottom)} = 25^\circ C$	Power Dissipation	29	
	Linear Derating Factor	0.021	W/°C
$T_J$ $T_{STG}$	Operating Junction and Storage Temperature Range	-55 to + 150	°C

Notes ① through ⑦ are on page 9

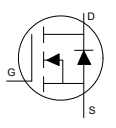
**Static @ T<sub>J</sub> = 25°C (unless otherwise specified)**

	Parameter	Min.	Typ.	Max.	Units	Conditions
BV <sub>DSS</sub>	Drain-to-Source Breakdown Voltage	25	—	—	V	V <sub>GS</sub> = 0V, I <sub>D</sub> = 250μA
ΔBV <sub>DSS</sub> /ΔT <sub>J</sub>	Breakdown Voltage Temp. Coefficient	—	22	—	mV/°C	Reference to 25°C, I <sub>D</sub> = 1mA
R <sub>DS(on)</sub>	Static Drain-to-Source On-Resistance	—	2.7	3.4	mΩ	V <sub>GS</sub> = 10V, I <sub>D</sub> = 30A ③
		—	3.7	4.6		V <sub>GS</sub> = 4.5V, I <sub>D</sub> = 30A ③
V <sub>GS(th)</sub>	Gate Threshold Voltage	1.1	1.6	2.1	V	V <sub>DS</sub> = V <sub>GS</sub> , I <sub>D</sub> = 35μA
ΔV <sub>GS(th)</sub>	Gate Threshold Voltage Coefficient	—	-5.4	—	mV/°C	
I <sub>DSS</sub>	Drain-to-Source Leakage Current	—	—	1.0	μA	V <sub>DS</sub> = 20V, V <sub>GS</sub> = 0V
I <sub>GSS</sub>	Gate-to-Source Forward Leakage	—	—	100	nA	V <sub>GS</sub> = 20V
	Gate-to-Source Reverse Leakage	—	—	-100		V <sub>GS</sub> = -20V
g <sub>fs</sub>	Forward Transconductance	120	—	—	S	V <sub>DS</sub> = 10V, I <sub>D</sub> = 30A
Q <sub>g</sub>	Total Gate Charge	—	20	—	nC	V <sub>GS</sub> = 10V, V <sub>DS</sub> = 13V, I <sub>D</sub> = 30A
Q <sub>g</sub>	Total Gate Charge	—	9.7	15	nC	V <sub>DS</sub> = 13V V <sub>GS</sub> = 4.5V I <sub>D</sub> = 30A
Q <sub>gs1</sub>	Pre-V <sub>th</sub> Gate-to-Source Charge	—	1.9	—		
Q <sub>gs2</sub>	Post-V <sub>th</sub> Gate-to-Source Charge	—	1.2	—		
Q <sub>gd</sub>	Gate-to-Drain Charge	—	3.6	—		
Q <sub>godr</sub>	Gate Charge Overdrive	—	3.0	—		
Q <sub>sw</sub>	Switch Charge (Q <sub>gs2</sub> + Q <sub>gd</sub> )	—	4.8	—		
Q <sub>oss</sub>	Output Charge	—	9.6	—	nC	V <sub>DS</sub> = 16V, V <sub>GS</sub> = 0V
R <sub>G</sub>	Gate Resistance	—	1.4	—	Ω	
t <sub>d(on)</sub>	Turn-On Delay Time	—	8.7	—	ns	V <sub>DD</sub> = 13V, V <sub>GS</sub> = 4.5V I <sub>D</sub> = 30A R <sub>G</sub> = 1.8Ω
t <sub>r</sub>	Rise Time	—	28	—		
t <sub>d(off)</sub>	Turn-Off Delay Time	—	12	—		
t <sub>f</sub>	Fall Time	—	5.9	—		
C <sub>iss</sub>	Input Capacitance	—	1270	—	pF	V <sub>GS</sub> = 0V V <sub>DS</sub> = 13V f = 1.0MHz
C <sub>oss</sub>	Output Capacitance	—	360	—		
C <sub>rss</sub>	Reverse Transfer Capacitance	—	97	—		

**Avalanche Characteristics**

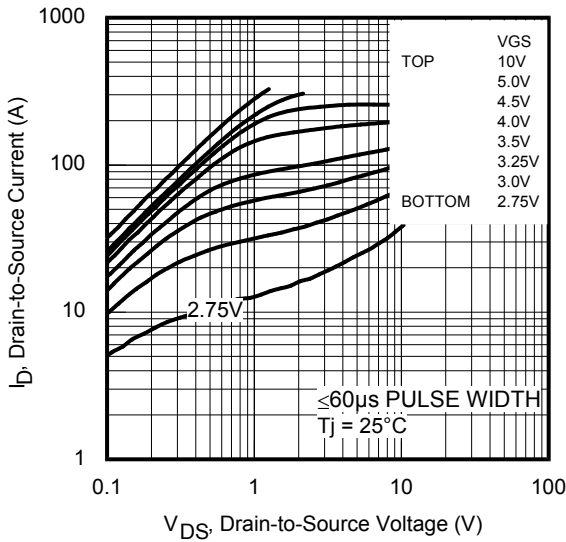
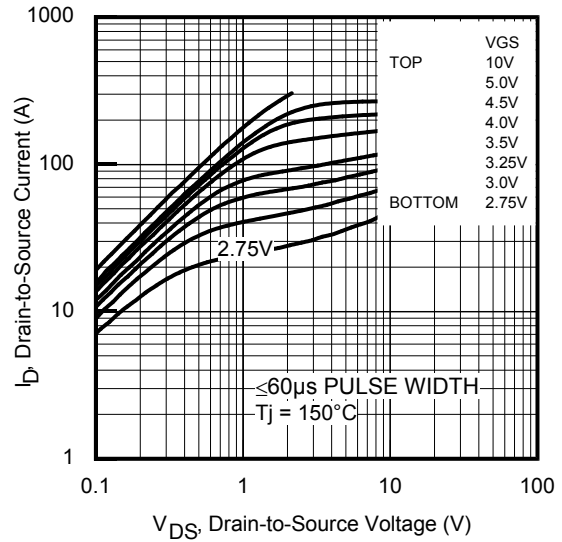
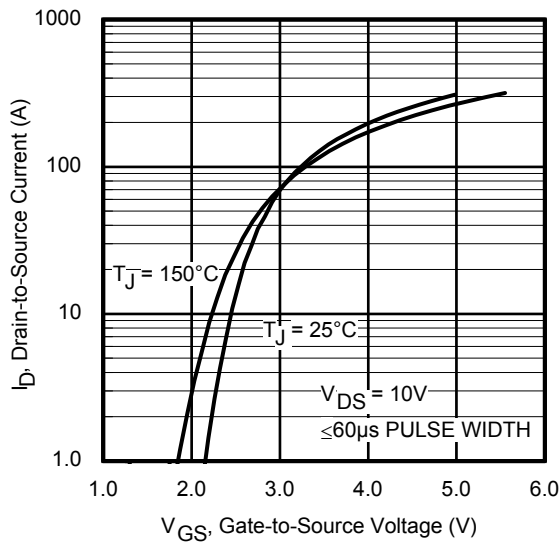
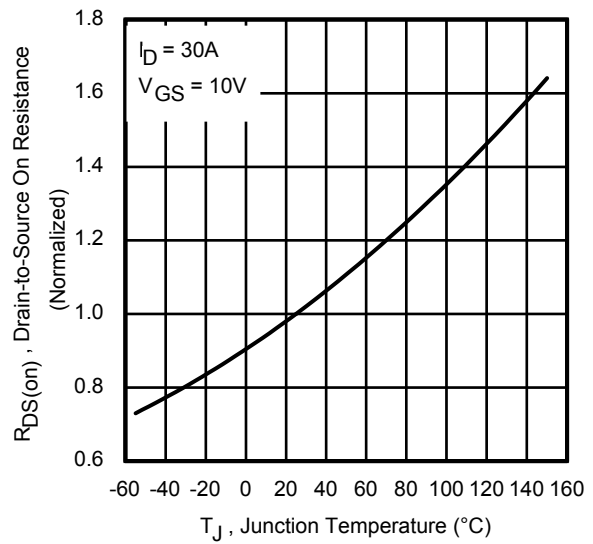
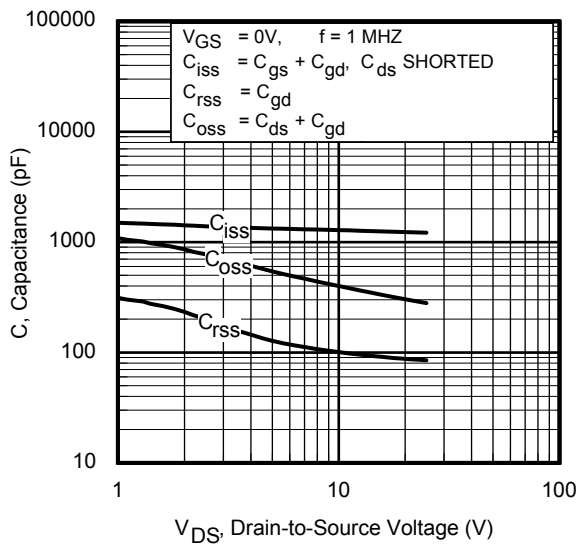
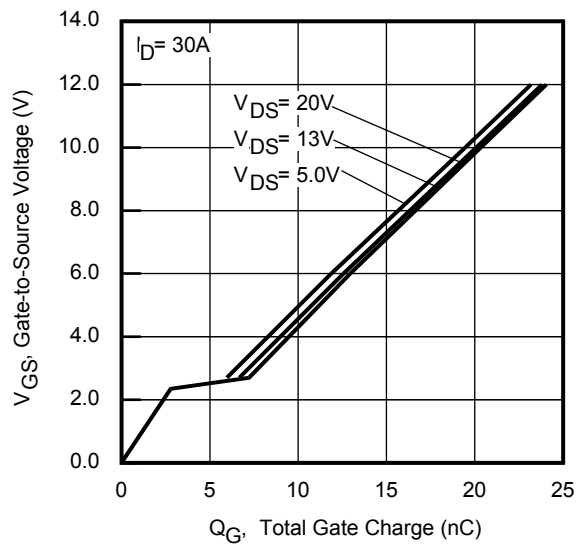
	Parameter	Typ.	Max.	Units
E <sub>AS</sub>	Single Pulse Avalanche Energy ②	—	42	mJ
I <sub>AR</sub>	Avalanche Current ①	—	30	A

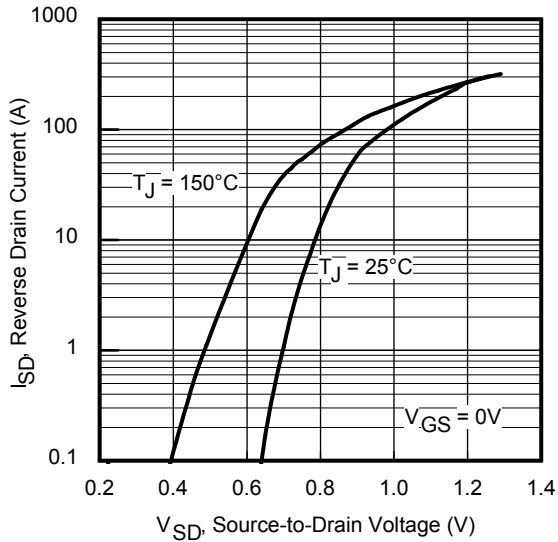
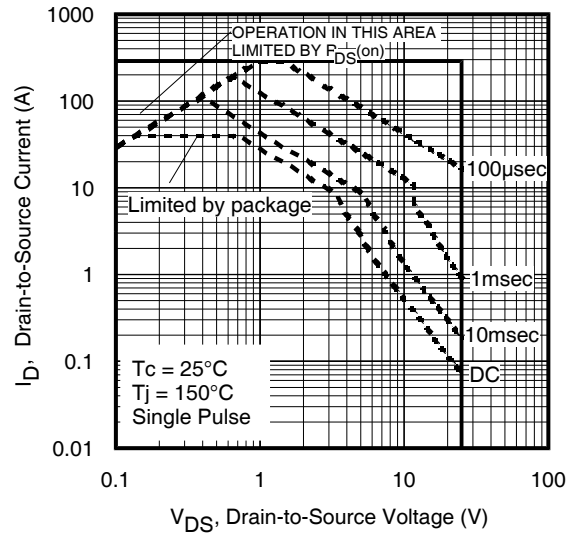
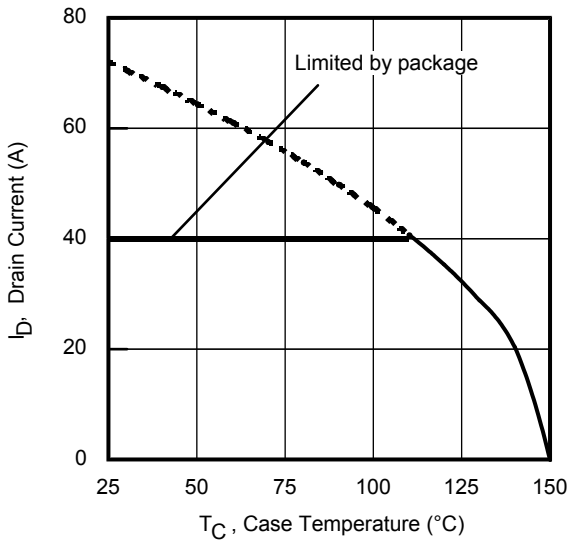
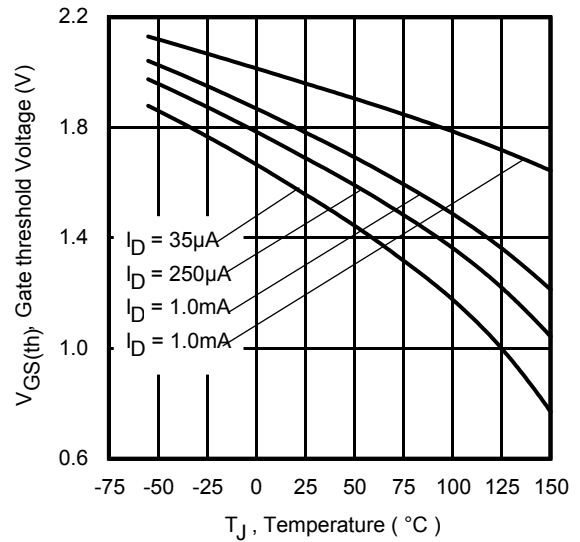
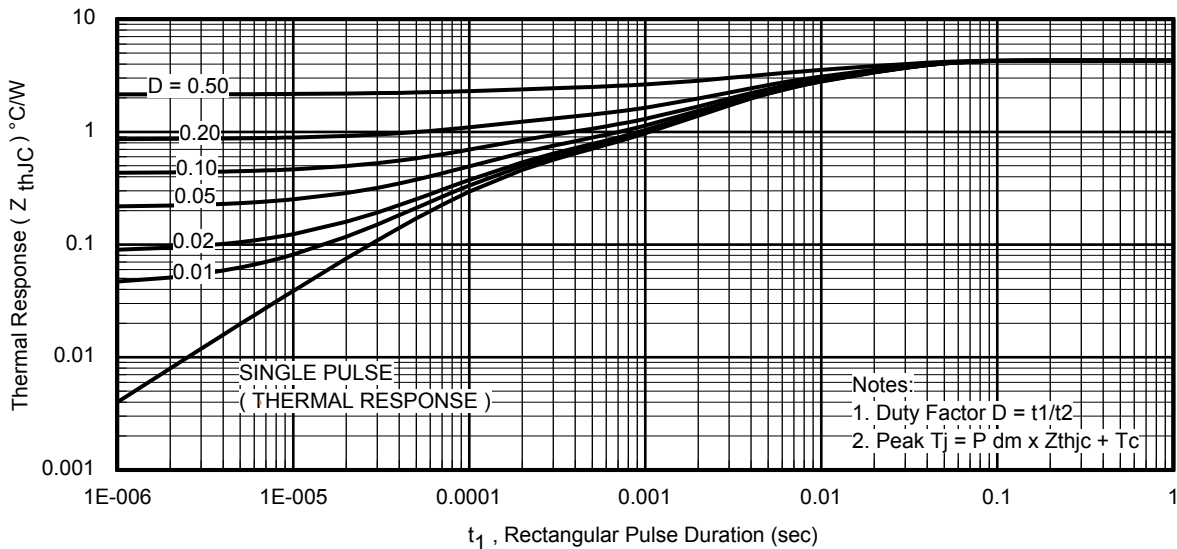
**Diode Characteristics**

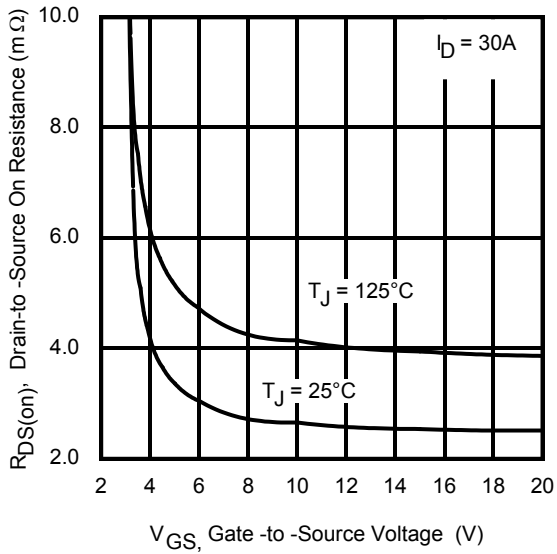
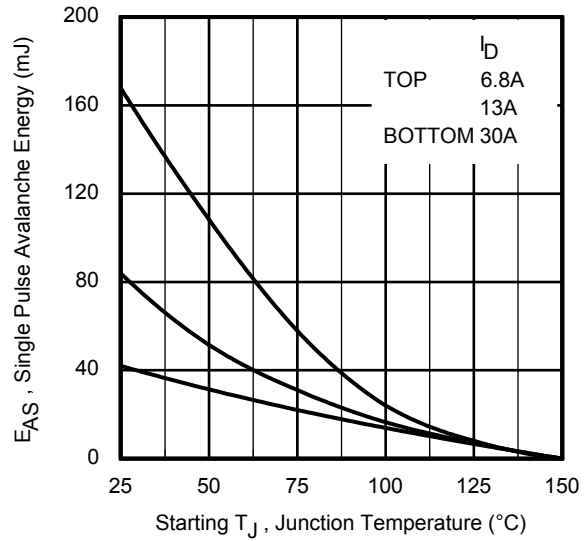
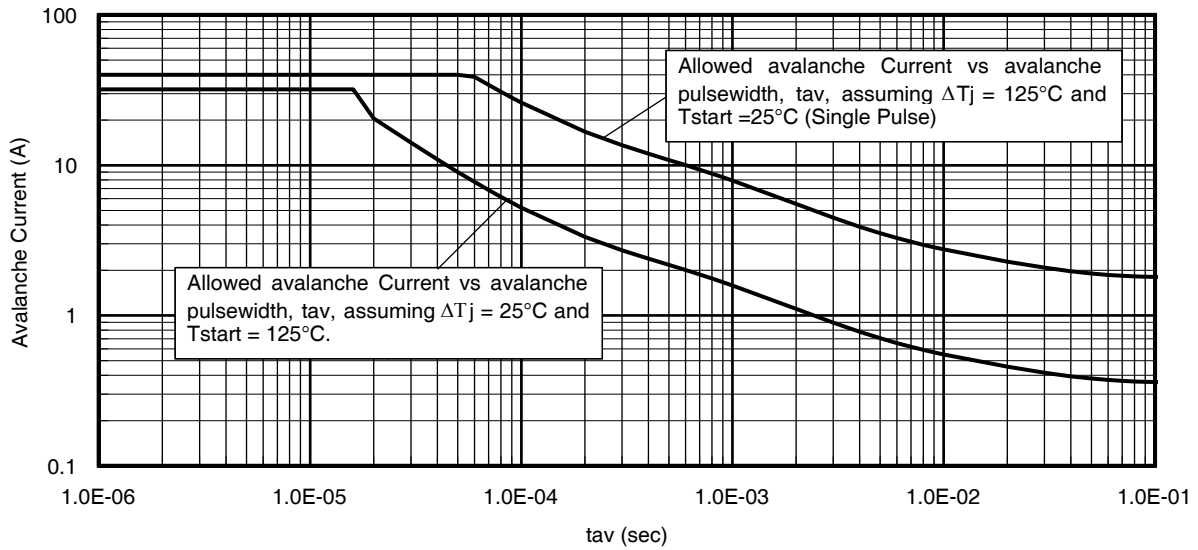
	Parameter	Min.	Typ.	Max.	Units	Conditions
I <sub>S</sub>	Continuous Source Current (Body Diode)	—	—	40⑦	A	MOSFET symbol showing the integral reverse p-n junction diode. 
I <sub>SM</sub>	Pulsed Source Current (Body Diode) ①	—	—	288		
V <sub>SD</sub>	Diode Forward Voltage	—	—	1.0	V	T <sub>J</sub> = 25°C, I <sub>S</sub> = 30A, V <sub>GS</sub> = 0V ③
t <sub>rr</sub>	Reverse Recovery Time	—	16	24	ns	T <sub>J</sub> = 25°C, I <sub>F</sub> = 30A, V <sub>DD</sub> = 13V
Q <sub>rr</sub>	Reverse Recovery Charge	—	13	20	nC	di/dt = 280A/μs ③

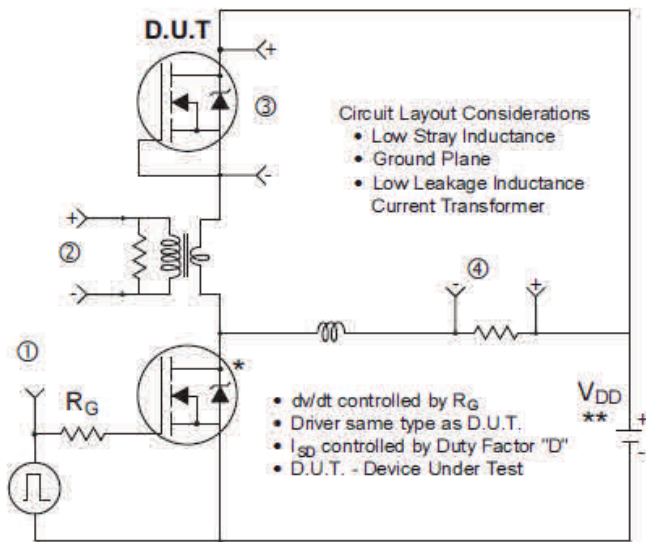
**Thermal Resistance**

	Parameter	Typ.	Max.	Units
R <sub>θJC</sub> (Bottom)	Junction-to-Case ④	—	4.3	°C/W
R <sub>θJC</sub> (Top)	Junction-to-Case ④	—	37	
R <sub>θJA</sub>	Junction-to-Ambient ⑤	—	47	
R <sub>θJA</sub> (<10s)	Junction-to-Ambient ⑤	—	31	


**Fig 1.** Typical Output Characteristics

**Fig 2.** Typical Output Characteristics

**Fig 3.** Typical Transfer Characteristics

**Fig 4.** Normalized On-Resistance vs. Temperature

**Fig 5.** Typical Capacitance vs. Drain-to-Source Voltage

**Fig 6.** Typical Gate Charge vs. Gate-to-Source Voltage

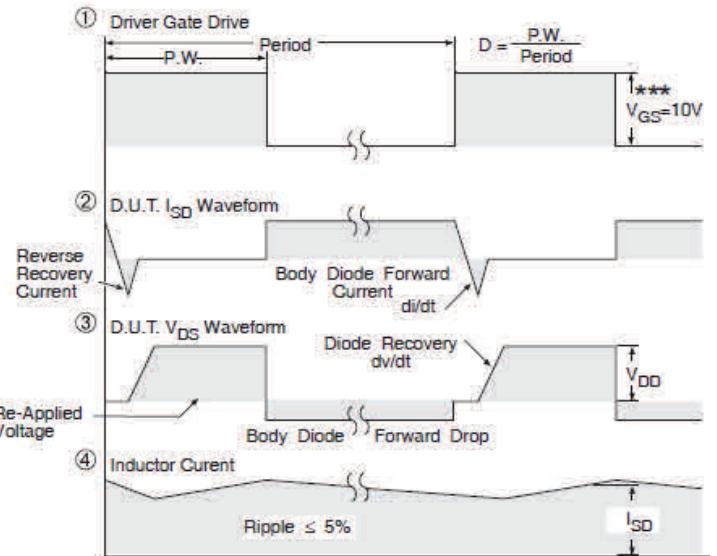

**Fig 7. Typical Source-Drain Diode Forward Voltage**

**Fig 8. Maximum Safe Operating Area**

**Fig 9. Maximum Drain Current vs. Case Temperature**

**Fig 10. Drain-to-Source Breakdown Voltage**

**Fig 11. Maximum Effective Transient Thermal Impedance, Junction-to-Case**


**Fig 12.** On-Resistance vs. Gate Voltage

**Fig 13.** Maximum Avalanche Energy vs. Drain Current

**Fig 14.** Typical Avalanche Current vs. Pulse Width

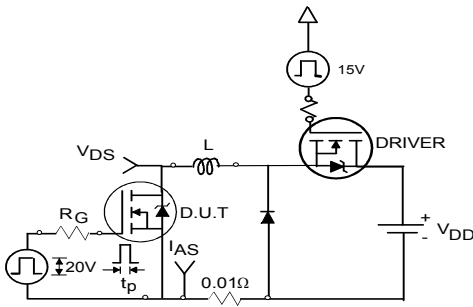


\* Use P-Channel Driver for P-Channel Measurements  
 \*\* Reverse Polarity for P-Channel

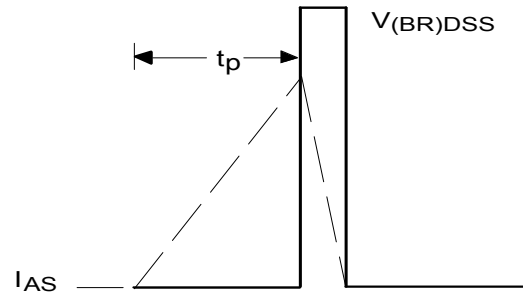
**Fig 15. Peak Diode Recovery dv/dt Test Circuit for N-Channel HEXFET® Power MOSFETs**



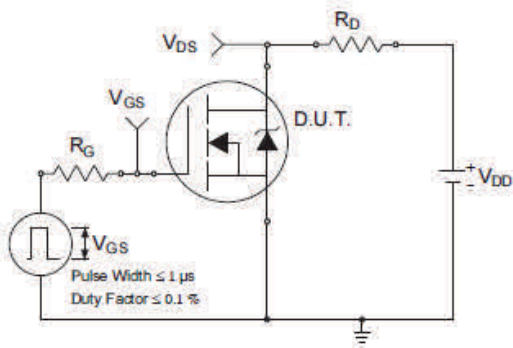
\*\*\*  $V_{GS} = 5V$  for Logic Level Devices



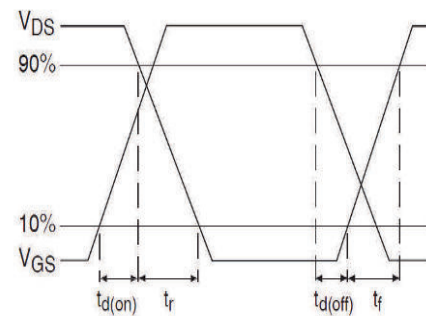
**Fig 16a. Unclamped Inductive Test Circuit**



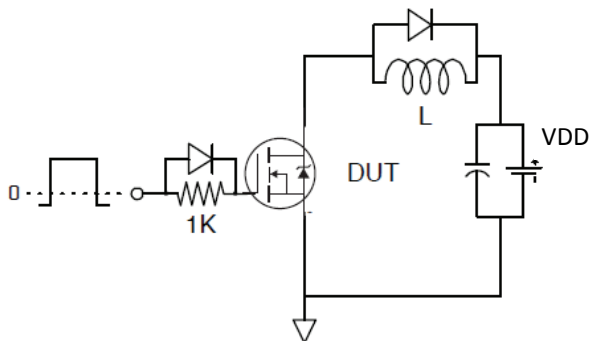
**Fig 16b. Unclamped Inductive Waveforms**



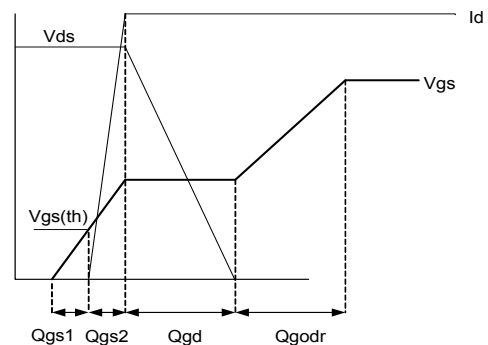
**Fig 17a. Switching Time Test Circuit**



**Fig 17b. Switching Time Waveforms**

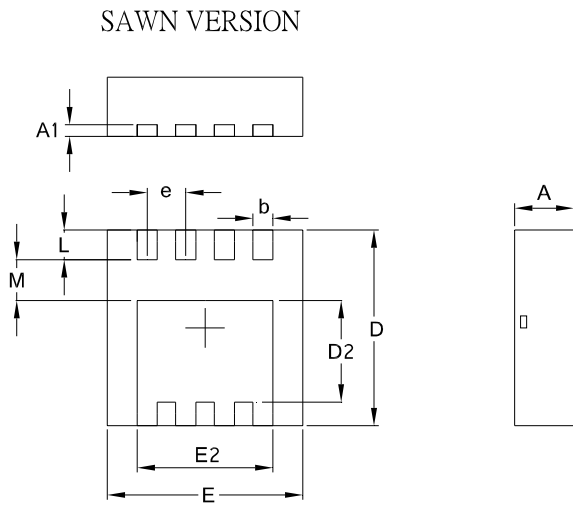


**Fig 18. Gate Charge Test Circuit**



**Fig 19. Gate Charge Waveform**

## PQFN 3.3 x 3.3 Outline “B” Package Details

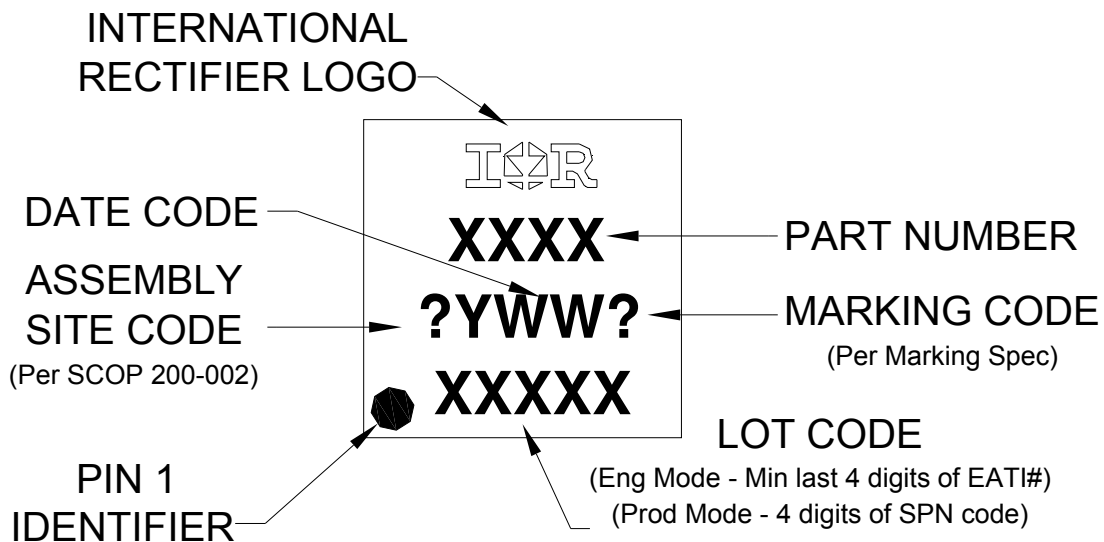


SYMBOL	COMMON			
	MM		INCH	
	MIN.	MAX.	MIN.	MAX.
A	0.70	1.05	0.0276	0.0413
A1	0.12	0.39	0.0047	0.0154
b	0.25	0.39	0.0098	0.0154
D	3.20	3.45	0.1260	0.1358
D1	3.00	3.20	0.1181	0.1417
D2	1.69	2.20	0.0665	0.0866
E	3.20	3.40	0.1260	0.1339
E1	3.00	3.20	0.1181	0.1417
E2	2.15	2.59	0.0846	0.1020
e	0.65 BSC		0.0256 BSC	
L	0.15	0.55	0.0059	0.0217
M	0.59	—	0.0232	—
O	9Deg	12Deg	9Deg	12Deg

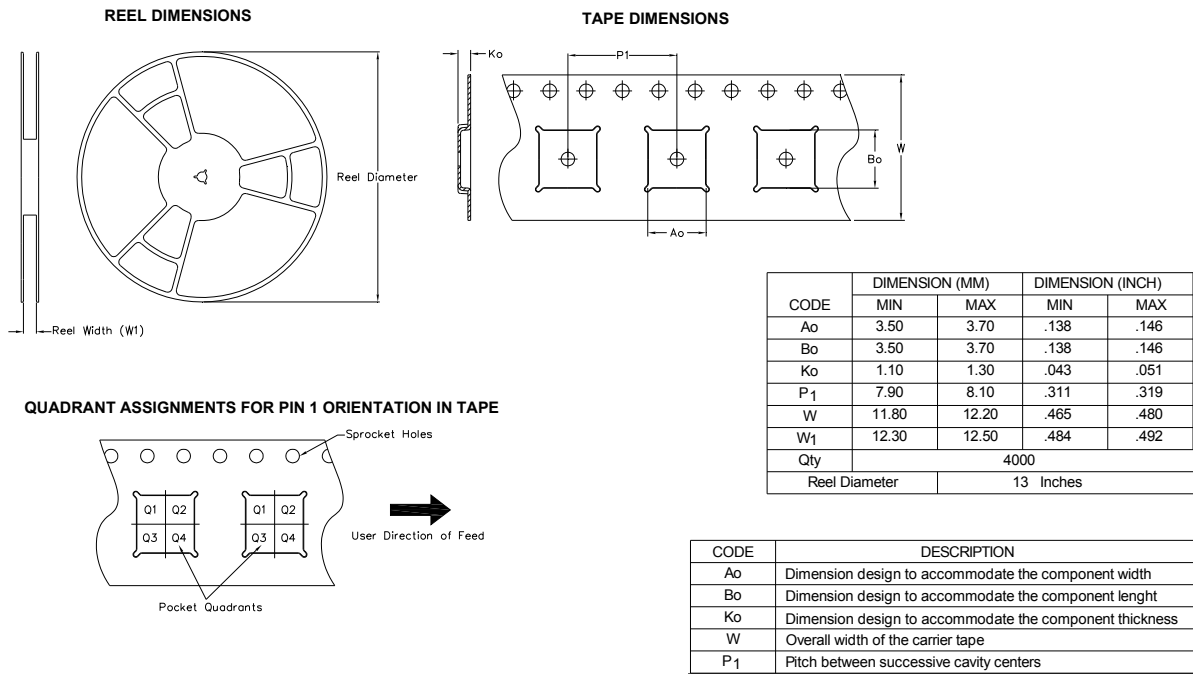
For more information on board mounting, including footprint and stencil recommendation, please refer to application note AN-1136: <http://www.irf.com/technical-info/appnotes/an-1136.pdf>

For more information on package inspection techniques, please refer to application note AN-1154: <http://www.irf.com/technical-info/appnotes/an-1154.pdf>

### PQFN 3.3 x 3.3 Part Marking



Note: For the most current drawing please refer to IR website at <http://www.irf.com/package/>

**PQFN 3.3 x 3.3 Tape and Reel**


Note: For the most current drawing please refer to IR website at <http://www.irf.com/package/>



**Qualification Information†**

<b>Qualification Level</b>	Industrial (per JEDEC JESD47F <sup>††</sup> guidelines)	
<b>Moisture Sensitivity Level</b>	PQFN 3.3mm x 3.3mm	MSL1 (per JEDEC J-STD-020D <sup>††</sup> )
<b>RoHS Compliant</b>	Yes	

† Qualification standards can be found at International Rectifier's web site: <http://www.irf.com/product-info/reliability>

†† Applicable version of JEDEC standard at the time of product release.

**Notes:**

- ① Repetitive rating; pulse width limited by max. junction temperature.
- ② Starting  $T_J = 25^\circ\text{C}$ ,  $L = 0.093\text{mH}$ ,  $R_G = 50\Omega$ ,  $I_{AS} = 30\text{A}$ .
- ③ Pulse width  $\leq 400\mu\text{s}$ ; duty cycle  $\leq 2\%$ .
- ④  $R_\theta$  is measured at  $T_J$  of approximately  $90^\circ\text{C}$ .
- ⑤ When mounted on 1 inch square PCB (FR-4). Please refer to AN-994 for more details:  
<http://www.irf.com/technical-info/appnotes/an-994.pdf>
- ⑥ Calculated continuous current based on maximum allowable junction temperature.
- ⑦ Current is limited to 40A by source bonding technology.

**Revision History**

Date	Comments
6/5/2014	<ul style="list-style-type: none"> <li>• Updated schematic on page 1</li> <li>• Updated tape and reel on page 9</li> </ul>
2/26/2016	<ul style="list-style-type: none"> <li>• Updated datasheet with corporate template</li> <li>• Corrected typo fig10 label from “25uA” to “35uA” on page 4.</li> <li>• Removed package outline “Punched Version” on page 7.</li> </ul>

**Published by**  
**Infineon Technologies AG**  
**81726 München, Germany**  
**© Infineon Technologies AG 2015**  
**All Rights Reserved.**

**IMPORTANT NOTICE**

The information given in this document shall in no event be regarded as a guarantee of conditions or characteristics (“Beschaffheitsgarantie”). With respect to any examples, hints or any typical values stated herein and/or any information regarding the application of the product, Infineon Technologies hereby disclaims any and all warranties and liabilities of any kind, including without limitation warranties of non-infringement of intellectual property rights of any third party.

In addition, any information given in this document is subject to customer’s compliance with its obligations stated in this document and any applicable legal requirements, norms and standards concerning customer’s products and any use of the product of Infineon Technologies in customer’s applications.

The data contained in this document is exclusively intended for technically trained staff. It is the responsibility of customer’s technical departments to evaluate the suitability of the product for the intended application and the completeness of the product information given in this document with respect to such application.

For further information on the product, technology, delivery terms and conditions and prices please contact your nearest Infineon Technologies office ([www.infineon.com](http://www.infineon.com)).

**WARNINGS**

Due to technical requirements products may contain dangerous substances. For information on the types in question please contact your nearest Infineon Technologies office.

Except as otherwise explicitly approved by Infineon Technologies in a written document signed by authorized representatives of Infineon Technologies, Infineon Technologies’ products may not be used in any applications where a failure of the product or any consequences of the use thereof can reasonably be expected to result in personal injury.