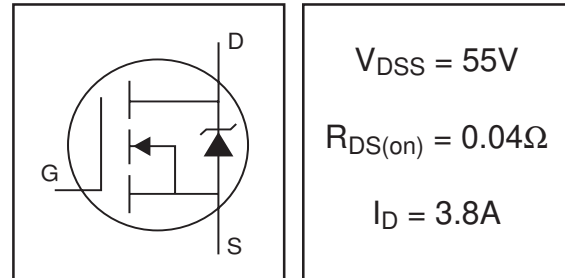


# IRLL2705

HEXFET® Power MOSFET

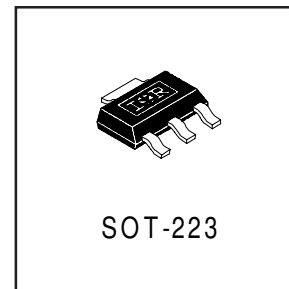
- Surface Mount
- Dynamic dv/dt Rating
- Logic-Level Gate Drive
- Fast Switching
- Ease of Paralleling
- Advanced Process Technology
- Ultra Low On-Resistance



## Description

Fifth Generation HEXFETs from International Rectifier utilize advanced processing techniques to achieve extremely low on-resistance per silicon area. This benefit, combined with the fast switching speed and ruggedized device design that HEXFET Power MOSFETs are well known for, provides the designer with an extremely efficient and reliable device for use in a wide variety of applications.

The SOT-223 package is designed for surface-mount using vapor phase, infra red, or wave soldering techniques. Its unique package design allows for easy automatic pick-and-place as with other SOT or SOIC packages but has the added advantage of improved thermal performance due to an enlarged tab for heatsinking. Power dissipation of 1.0W is possible in a typical surface mount application



## Absolute Maximum Ratings

	Parameter	Max.	Units
$I_D @ T_A = 25^\circ C$	Continuous Drain Current, $V_{GS} @ 10V^{**}$	5.2	A
$I_D @ T_A = 25^\circ C$	Continuous Drain Current, $V_{GS} @ 10V^*$	3.8	
$I_D @ T_A = 70^\circ C$	Continuous Drain Current, $V_{GS} @ 10V^*$	3.0	
$I_{DM}$	Pulsed Drain Current ①	30	
$P_D @ T_A = 25^\circ C$	Power Dissipation (PCB Mount)**	2.1	W
$P_D @ T_A = 25^\circ C$	Power Dissipation (PCB Mount)*	1.0	W
	Linear Derating Factor (PCB Mount)*	8.3	mW/°C
$V_{GS}$	Gate-to-Source Voltage	$\pm 16$	V
$E_{AS}$	Single Pulse Avalanche Energy②	110	mJ
$I_{AR}$	Avalanche Current①	3.8	A
$E_{AR}$	Repetitive Avalanche Energy①	0.10	mJ
dv/dt	Peak Diode Recovery dv/dt ③	7.5	V/ns
$T_J, T_{STG}$	Junction and Storage Temperature Range	-55 to + 150	°C

## Thermal Resistance

	Parameter	Typ.	Max.	Units
$R_{\theta JA}$	Junction-to-Amb. (PCB Mount, steady state)*	93	120	°C/W
$R_{\theta JA}$	Junction-to-Amb. (PCB Mount, steady state)**	48	60	

\* When mounted on FR-4 board using minimum recommended footprint.

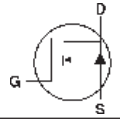
\*\* When mounted on 1 inch square copper board, for comparison with other SMD devices.

www.irf.com

## Electrical Characteristics @ T<sub>J</sub> = 25°C (unless otherwise specified)

	Parameter	Min.	Typ.	Max.	Units	Conditions
V <sub>(BR)DSS</sub>	Drain-to-Source Breakdown Voltage	55	—	—	V	V <sub>GS</sub> = 0V, I <sub>D</sub> = 250μA
ΔV <sub>(BR)DSS</sub> /ΔT <sub>J</sub>	Breakdown Voltage Temp. Coefficient	—	0.061	—	V/°C	Reference to 25°C, I <sub>D</sub> = 1mA
R <sub>DS(on)</sub>	Static Drain-to-Source On-Resistance	—	—	0.040	Ω	V <sub>GS</sub> = 10V, I <sub>D</sub> = 3.8A ④
		—	—	0.051		V <sub>GS</sub> = 5.0V, I <sub>D</sub> = 3.8A ④
		—	—	0.065		V <sub>GS</sub> = 4.0V, I <sub>D</sub> = 1.9A ④
V <sub>GS(th)</sub>	Gate Threshold Voltage	1.0	—	2.0	V	V <sub>DS</sub> = V <sub>GS</sub> , I <sub>D</sub> = 250μA
g <sub>fs</sub>	Forward Transconductance	5.1	—	—	S	V <sub>DS</sub> = 25V, I <sub>D</sub> = 1.9A
I <sub>DSS</sub>	Drain-to-Source Leakage Current	—	—	25	μA	V <sub>DS</sub> = 55V, V <sub>GS</sub> = 0V
		—	—	250		V <sub>DS</sub> = 44V, V <sub>GS</sub> = 0V, T <sub>J</sub> = 150°C
I <sub>GSS</sub>	Gate-to-Source Forward Leakage	—	—	100	nA	V <sub>GS</sub> = 16V
	Gate-to-Source Reverse Leakage	—	—	-100		V <sub>GS</sub> = -16V
Q <sub>g</sub>	Total Gate Charge	—	32	48	nC	I <sub>D</sub> = 3.8A
Q <sub>gs</sub>	Gate-to-Source Charge	—	3.5	5.3		V <sub>DS</sub> = 44V
Q <sub>gd</sub>	Gate-to-Drain ("Miller") Charge	—	9.7	14		V <sub>GS</sub> = 10V, See Fig. 6 and 9 ④
t <sub>d(on)</sub>	Turn-On Delay Time	—	6.2	—	ns	V <sub>DD</sub> = 28V
t <sub>r</sub>	Rise Time	—	12	—		I <sub>D</sub> = 3.8A
t <sub>d(off)</sub>	Turn-Off Delay Time	—	35	—		R <sub>G</sub> = 6.2Ω
t <sub>f</sub>	Fall Time	—	22	—		R <sub>D</sub> = 7.1Ω, See Fig. 10 ④
C <sub>iss</sub>	Input Capacitance	—	870	—	pF	V <sub>GS</sub> = 0V
C <sub>oss</sub>	Output Capacitance	—	220	—		V <sub>DS</sub> = 25V
C <sub>rss</sub>	Reverse Transfer Capacitance	—	92	—		f = 1.0MHz, See Fig. 5

## Source-Drain Ratings and Characteristics

	Parameter	Min.	Typ.	Max.	Units	Conditions
I <sub>S</sub>	Continuous Source Current (Body Diode)	—	—	0.91	A	MOSFET symbol showing the integral reverse p-n junction diode. 
I <sub>SM</sub>	Pulsed Source Current (Body Diode) ①	—	—	30		
V <sub>SD</sub>	Diode Forward Voltage	—	—	1.3	V	T <sub>J</sub> = 25°C, I <sub>S</sub> = 3.8A, V <sub>GS</sub> = 0V ④
t <sub>rr</sub>	Reverse Recovery Time	—	58	88	ns	T <sub>J</sub> = 25°C, I <sub>F</sub> = 3.8A
Q <sub>rr</sub>	Reverse Recovery Charge	—	140	210	nC	di/dt = 100A/μs ④
t <sub>on</sub>	Forward Turn-On Time	Intrinsic turn-on time is negligible (turn-on is dominated by L <sub>S</sub> +L <sub>D</sub> )				

### Notes:

- ① Repetitive rating; pulse width limited by max. junction temperature. ( See fig. 11 )
- ② V<sub>DD</sub> = 25V, starting T<sub>J</sub> = 25°C, L = 15mH  
R<sub>G</sub> = 25Ω, I<sub>AS</sub> = 3.8A. (See Figure 12)
- ③ I<sub>SD</sub> ≤ 3.8A, di/dt ≤ 220A/μs, V<sub>DD</sub> ≤ V<sub>(BR)DSS</sub>,  
T<sub>J</sub> ≤ 150°C
- ④ Pulse width ≤ 300μs; duty cycle ≤ 2%.

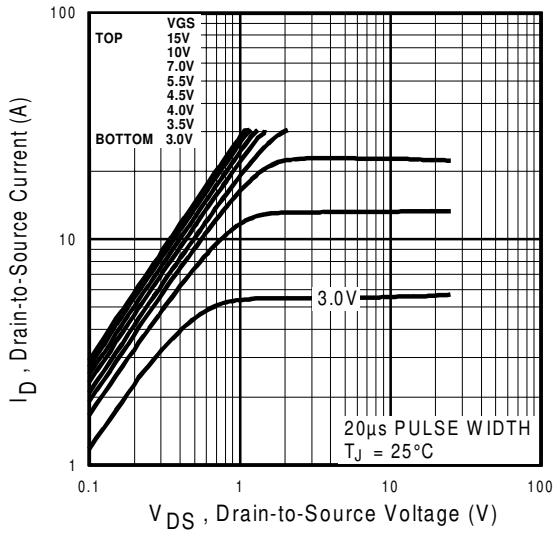


Fig 1. Typical Output Characteristics

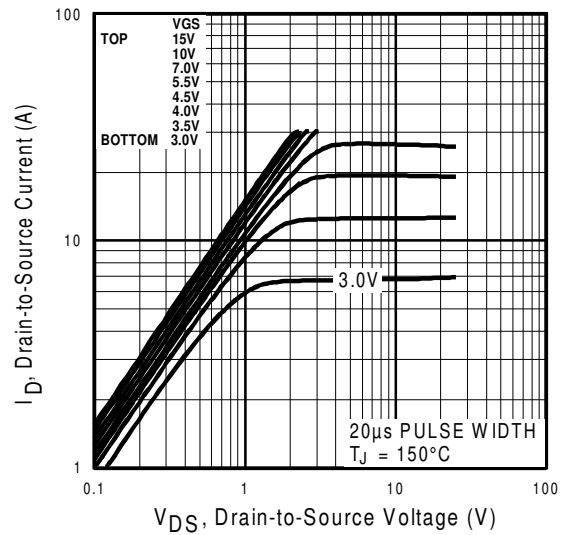


Fig 2. Typical Output Characteristics

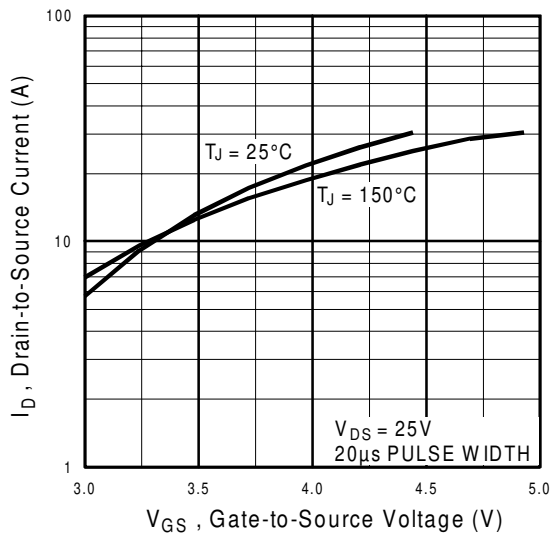


Fig 3. Typical Transfer Characteristics

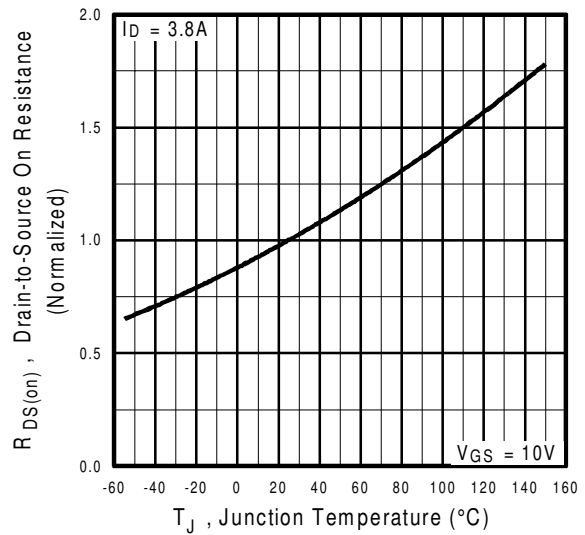
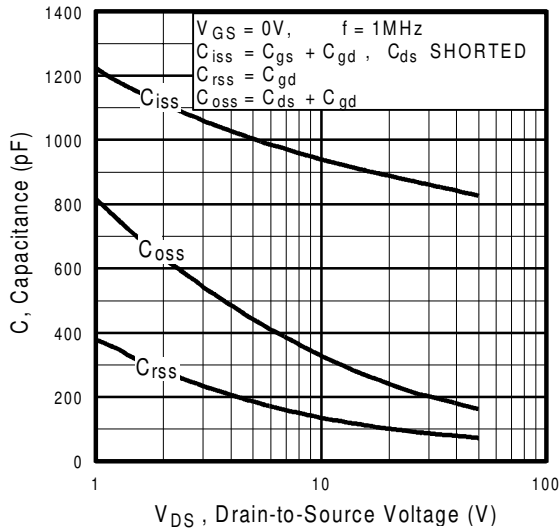
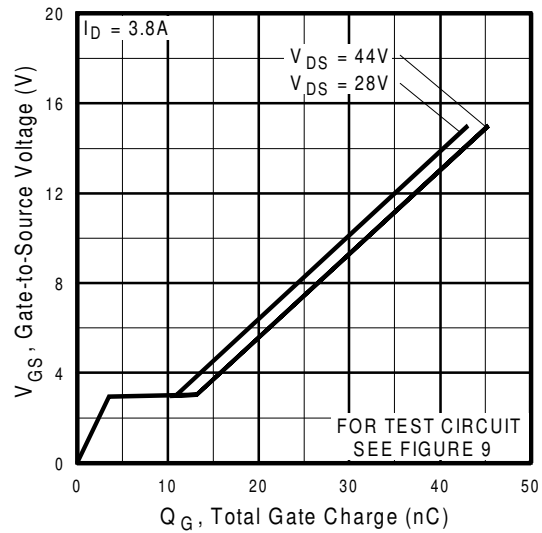


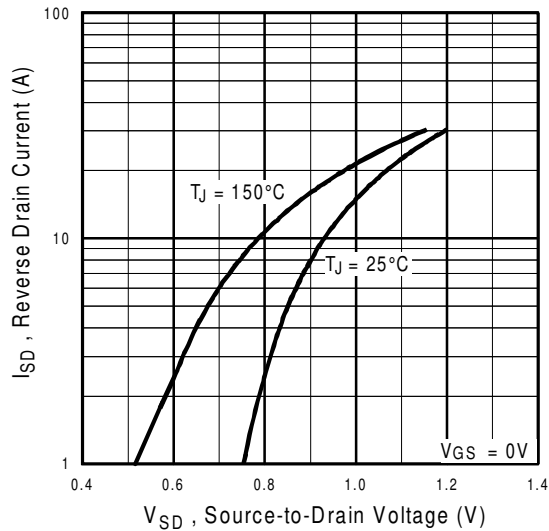
Fig 4. Normalized On-Resistance Vs. Temperature



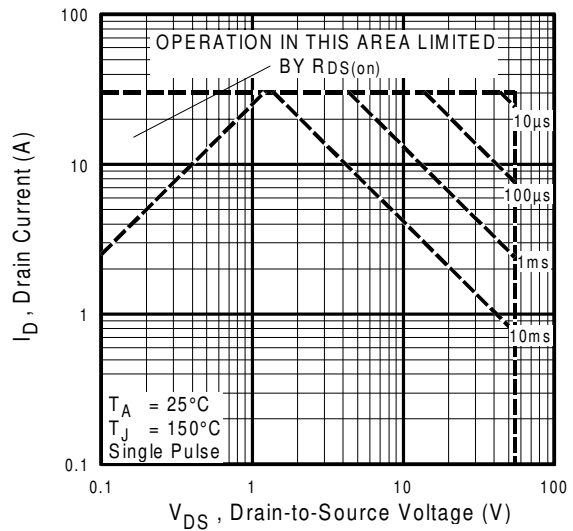
**Fig 5.** Typical Capacitance Vs. Drain-to-Source Voltage



**Fig 6.** Typical Gate Charge Vs. Gate-to-Source Voltage



**Fig 7.** Typical Source-Drain Diode Forward Voltage



**Fig 8.** Maximum Safe Operating Area

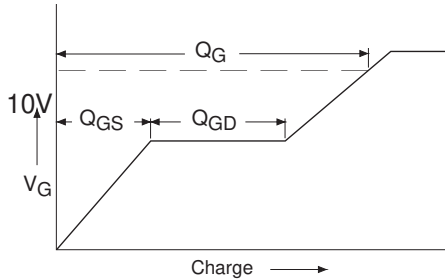


Fig 9a. Basic Gate Charge Waveform

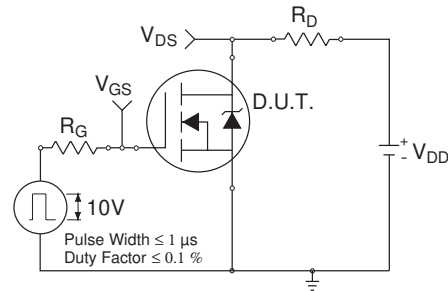


Fig 10a. Switching Time Test Circuit

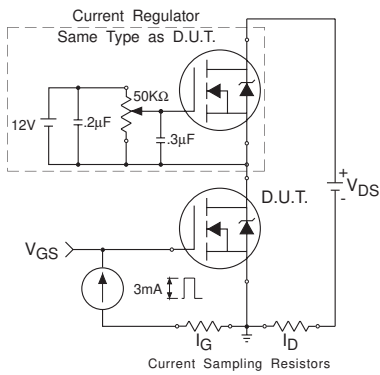


Fig 9b. Gate Charge Test Circuit

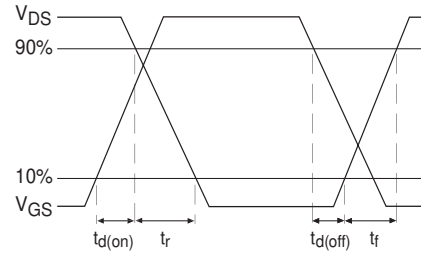


Fig 10b. Switching Time Waveforms

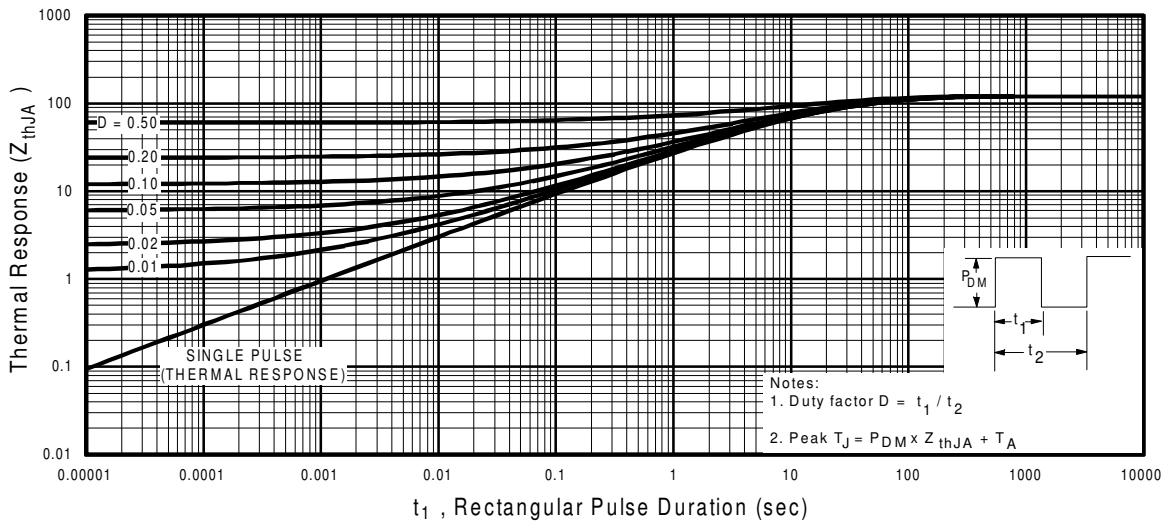
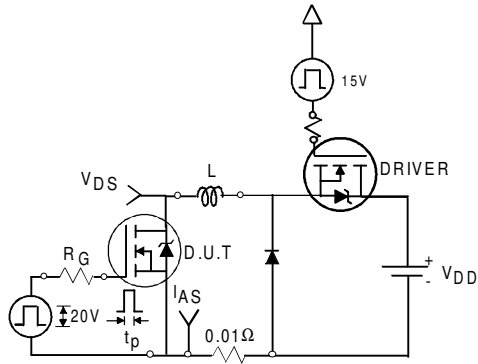
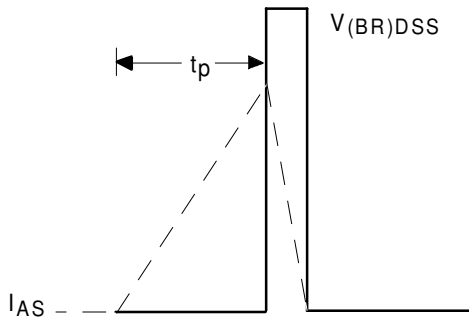


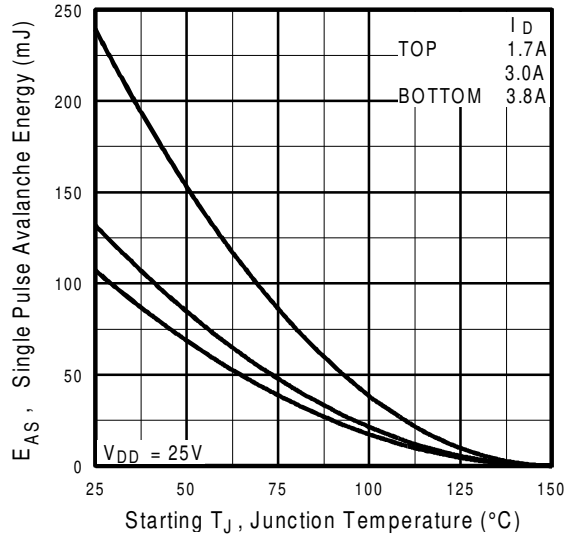
Fig 11. Maximum Effective Transient Thermal Impedance, Junction-to-Ambient



**Fig 12a.** Unclamped Inductive Test Circuit

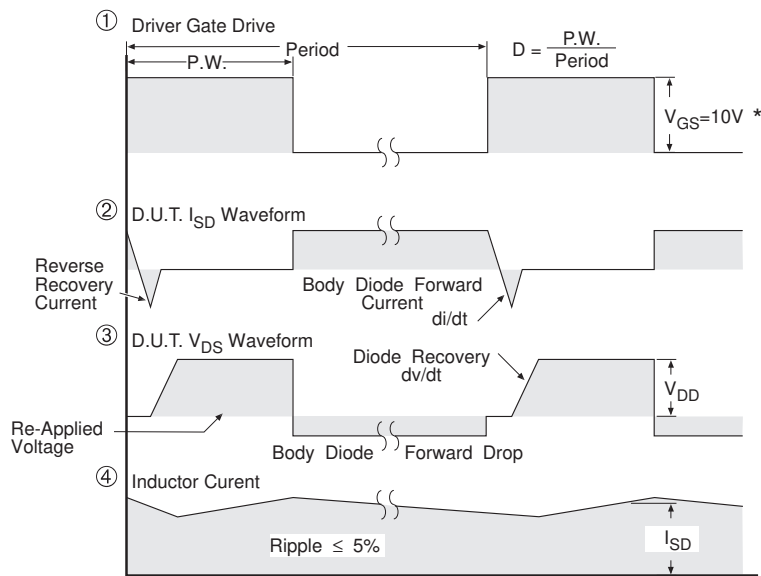
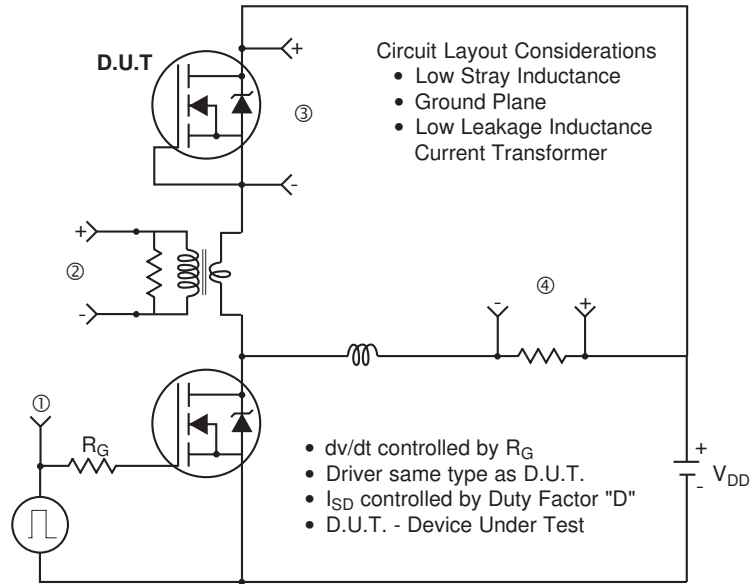


**Fig 12b.** Unclamped Inductive Waveforms



**Fig 12c.** Maximum Avalanche Energy Vs. Drain Current

**Peak Diode Recovery dv/dt Test Circuit**



\*  $V_{GS} = 5V$  for Logic Level Devices

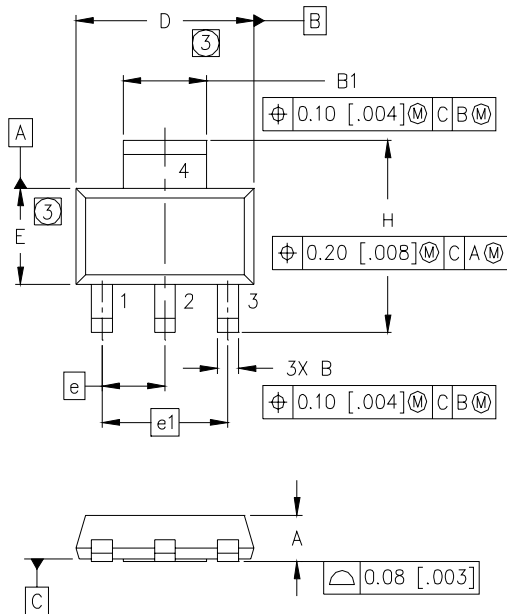
**Fig 13. For N-Channel HEXFETS**

# IRLL2705

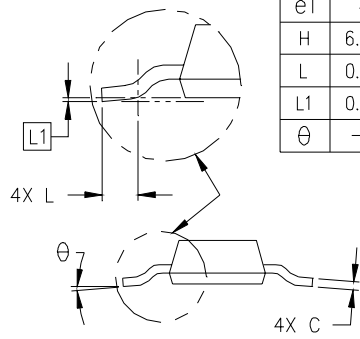
## Package Outline

SOT-223 (TO-261AA) Outline

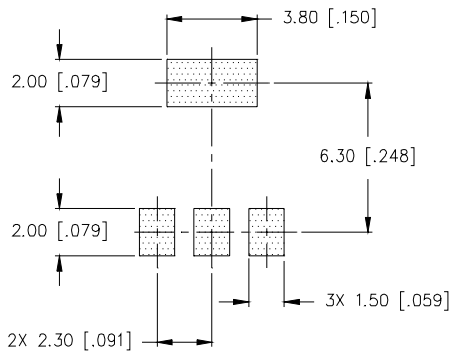
International  
**IR** Rectifier



DIM	MILLIMETERS		INCHES	
	MIN	MAX	MIN	MAX
A	1.55	1.80	.061	.071
B	0.65	0.85	.026	.033
B1	2.95	3.15	.116	.124
C	0.25	0.35	.010	.014
D	6.30	6.70	.248	.264
E	3.30	3.70	.130	.146
e	2.30	BSC	.0905	BSC
e1	4.60	BSC	.181	BSC
H	6.71	7.29	.264	.287
L	0.91	—	.036	—
L1	0.061	BSC	.0024	BSC
θ	—	10°	—	10°



MINIMUM RECOMMENDED FOOTPRINT



LEAD ASSIGNMENTS

- 1 = GATE
- 2 = DRAIN
- 3 = SOURCE
- 4 = DRAIN

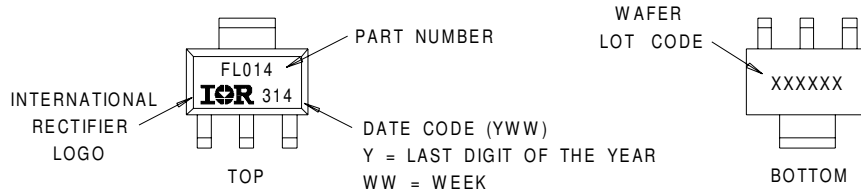
NOTES:

1. DIMENSIONING & TOLERANCING PER ASME Y14.5M-1994.
2. CONTROLLING DIMENSION: INCH.
3. DIMENSIONS DO NOT INCLUDE MOLD FLASH.
4. OUTLINE CONFORMS TO JEDEC OUTLINE TO-261AA.
5. DIMENSIONS ARE SHOWN IN MILLIMETERS [INCHES].

## Part Marking Information

SOT-223

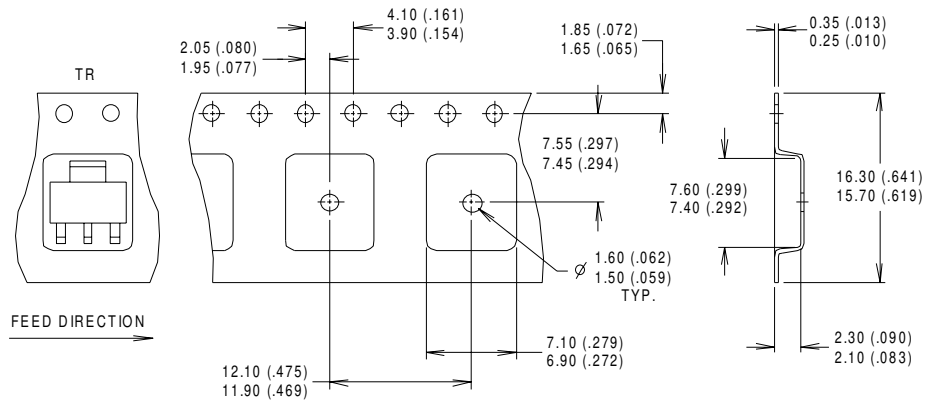
EXAMPLE: THIS IS AN IRFL014



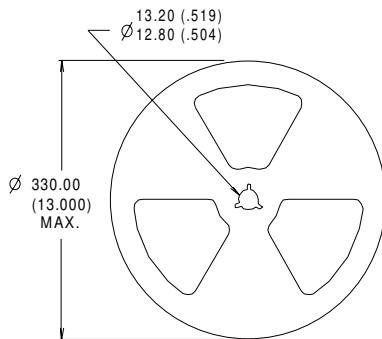


**Tape & Reel Information**

**SOT-223 Outline**



- NOTES :
1. CONTROLLING DIMENSION: MILLIMETER.
  2. OUTLINE CONFORMS TO EIA-481 & EIA-541.
  3. EACH  $\varnothing 330.00$  (13.00) REEL CONTAINS 2,500 DEVICES.



- NOTES :
1. OUTLINE COMFORMS TO EIA-418-1.
  2. CONTROLLING DIMENSION: MILLIMETER..
  - ③ DIMENSION MEASURED @ HUB.
  - ④ INCLUDES FLANGE DISTORTION @ OUTER EDGE.

