

CoolMOS™ Power Transistor

Features

- New revolutionary high voltage technology
- Extreme dv/dt rated
- High peak current capability
- Qualified according to JEDEC¹⁾ for target applications
- Pb-free lead plating; RoHS compliant
- Ultra low gate charge
- Ultra low effective capacitances

Product Summary

V_{DS}	800	V
$R_{DS(on)max} @ T_j = 25^\circ\text{C}$	2.7	Ω
$Q_{g,typ}$	12	nC

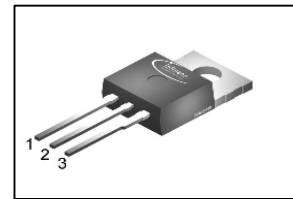
PG-TO220-3

CoolMOS™ 800V designed for:

- Industrial application with high DC bulk voltage
- Switching Application (i.e. active clamp forward)

Type	Package	Marking
SPP02N80C3	PG-TO220-3	02N80C3

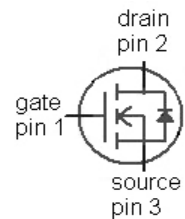

Maximum ratings, at $T_j=25^\circ\text{C}$, unless otherwise specified

Parameter	Symbol	Conditions	Value	Unit
Continuous drain current	I_D	$T_C=25^\circ\text{C}$	2	A
		$T_C=100^\circ\text{C}$	1.2	
Pulsed drain current ²⁾	$I_{D,pulse}$	$T_C=25^\circ\text{C}$	6	
Avalanche energy, single pulse	E_{AS}	$I_D=1\text{ A}, V_{DD}=50\text{ V}$	90	mJ
Avalanche energy, repetitive $t_{AR}^{2),3)}$	E_{AR}	$I_D=2\text{ A}, V_{DD}=50\text{ V}$	0.05	
Avalanche current, repetitive $t_{AR}^{2),3)}$	I_{AR}		2	A
MOSFET dv/dt ruggedness	dv/dt	$V_{DS}=0\dots640\text{ V}$	50	V/ns
Gate source voltage	V_{GS}	static	± 20	V
		AC ($f>1\text{ Hz}$)	± 30	
Power dissipation	P_{tot}	$T_C=25^\circ\text{C}$	42	W
Operating and storage temperature	T_j, T_{stg}		-55 ... 150	$^\circ\text{C}$
Mounting torque		M3 and M3.5 screws	60	Ncm

Maximum ratings, at $T_j=25\text{ °C}$, unless otherwise specified

Parameter	Symbol	Conditions	Value	Unit
Continuous diode forward current	I_S	$T_C=25\text{ °C}$	2	A
Diode pulse current ²⁾	$I_{S,pulse}$		6	
Reverse diode dv/dt ⁴⁾	dv/dt		4	V/ns

Parameter	Symbol	Conditions	Values			Unit
			min.	typ.	max.	

Thermal characteristics

Thermal resistance, junction - case	R_{thJC}		-	-	3	K/W
Thermal resistance, junction - ambient	R_{thJA}	leaded	-	-	62	
Soldering temperature, wave soldering only allowed at leads	T_{sold}	1.6 mm (0.063 in.) from case for 10s	-	-	260	°C

Electrical characteristics, at $T_j=25\text{ °C}$, unless otherwise specified

Static characteristics

Drain-source breakdown voltage	$V_{(BR)DSS}$	$V_{GS}=0\text{ V}$, $I_D=250\text{ }\mu\text{A}$	800	-	-	V
Avalanche breakdown voltage	$V_{(BR)DS}$	$V_{GS}=0\text{ V}$, $I_D=2\text{ A}$	-	870	-	
Gate threshold voltage	$V_{GS(th)}$	$V_{DS}=V_{GS}$, $I_D=0.12\text{ mA}$	2.1	3	3.9	
Zero gate voltage drain current	I_{DSS}	$V_{DS}=800\text{ V}$, $V_{GS}=0\text{ V}$, $T_j=25\text{ °C}$	-	-	5	μA
		$V_{DS}=800\text{ V}$, $V_{GS}=0\text{ V}$, $T_j=150\text{ °C}$	-	25	-	
Gate-source leakage current	I_{GSS}	$V_{GS}=20\text{ V}$, $V_{DS}=0\text{ V}$	-	-	100	nA
Drain-source on-state resistance	$R_{DS(on)}$	$V_{GS}=10\text{ V}$, $I_D=1.2\text{ A}$, $T_j=25\text{ °C}$	-	2.4	2.7	Ω
		$V_{GS}=10\text{ V}$, $I_D=1.2\text{ A}$, $T_j=150\text{ °C}$	-	6.5	-	
Gate resistance	R_G	$f=1\text{ MHz}$, open drain	-	1.2	-	Ω

Parameter	Symbol	Conditions	Values			Unit
			min.	typ.	max.	

Dynamic characteristics

Input capacitance	C_{iss}	$V_{GS}=0\text{ V}, V_{DS}=100\text{ V},$	-	290	-	pF
Output capacitance	C_{oss}	$f=1\text{ MHz}$	-	13	-	
Effective output capacitance, energy related ⁵⁾	$C_{o(er)}$	$V_{GS}=0\text{ V}, V_{DS}=0\text{ V}$ to 480 V	-	11	-	
Effective output capacitance, time related ⁶⁾	$C_{o(tr)}$		-	26	-	
Turn-on delay time	$t_{d(on)}$	$V_{DD}=400\text{ V},$ $V_{GS}=0/10\text{ V}, I_D=2\text{ A},$ $R_G=47\text{ }\Omega, T_j=25\text{ }^\circ\text{C}$	-	25	-	ns
Rise time	t_r		-	15	-	
Turn-off delay time	$t_{d(off)}$		-	72	-	
Fall time	t_f		-	18	-	

Gate Charge Characteristics

Gate to source charge	Q_{gs}	$V_{DD}=640\text{ V}, I_D=2\text{ A},$ $V_{GS}=0\text{ to }10\text{ V}$	-	1.5	-	nC
Gate to drain charge	Q_{gd}		-	6	-	
Gate charge total	Q_g		-	12	16	
Gate plateau voltage	$V_{plateau}$		-	5.5	-	V

Reverse Diode

Diode forward voltage	V_{SD}	$V_{GS}=0\text{ V}, I_F=I_S=2\text{ A},$ $T_j=25\text{ }^\circ\text{C}$	-	1	1.2	V
Reverse recovery time	t_{rr}	$V_R=400\text{ V}, I_F=I_S=2\text{ A},$ $di_F/dt=100\text{ A}/\mu\text{s}$	-	520	-	ns
Reverse recovery charge	Q_{rr}		-	2	-	μC
Peak reverse recovery current	I_{rrm}		-	6	-	A

¹⁾ J-STD20 and JESD22

²⁾ Pulse width t_p limited by $T_{j,max}$

³⁾ Repetitive avalanche causes additional power losses that can be calculated as $P_{AV}=E_{AR} \cdot f$.

⁴⁾ $I_{SD}=I_D, di/dt=400\text{ A}/\mu\text{s}, V_{DClink} = 400\text{ V}, V_{peak}<V_{(BR)DSS}, T_j<T_{j,max}$, identical low side and high side switch

⁵⁾ $C_{o(er)}$ is a fixed capacitance that gives the same stored energy as C_{oss} while V_{DS} is rising from 0 to 80% V_{DSS} .

⁶⁾ $C_{o(tr)}$ is a fixed capacitance that gives the same charging time as C_{oss} while V_{DS} is rising from 0 to 80% V_{DSS} .

1 Power dissipation

$$P_{tot}=f(T_C)$$

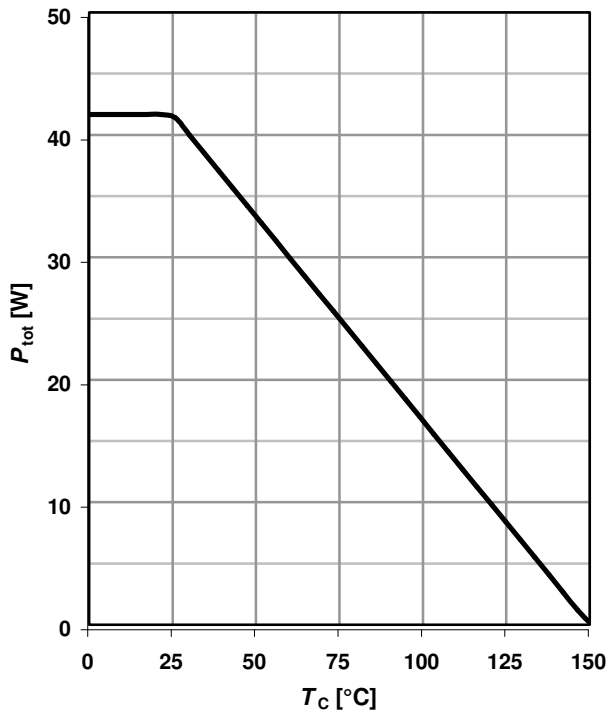

2 Safe operating area

$$I_D=f(V_{DS}); T_C=25\text{ °C}; D=0$$

parameter: t_p

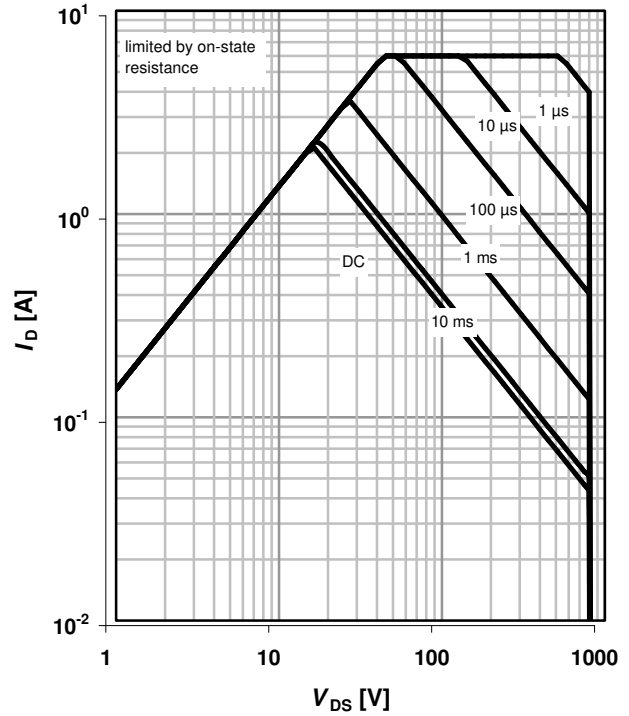

3 Max. transient thermal impedance

$$Z_{thJC}=f(t_p)$$

parameter: $D=t_p/T$

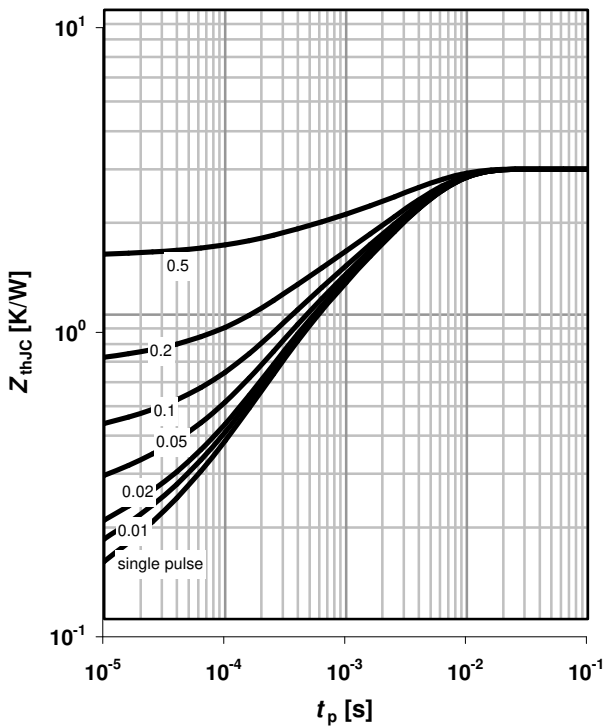

4 Typ. output characteristics

$$I_D=f(V_{DS}); T_j=25\text{ °C}; t_p=10\text{ }\mu\text{s}$$

parameter: V_{GS}

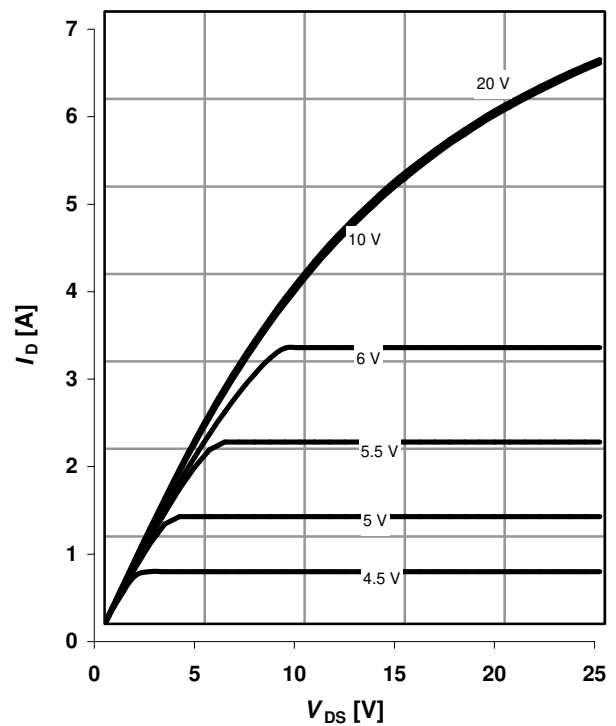

5 Typ. output characteristics

$I_D=f(V_{DS}); T_j=150\text{ °C}; t_p=10\text{ }\mu\text{s}$

parameter: V_{GS}

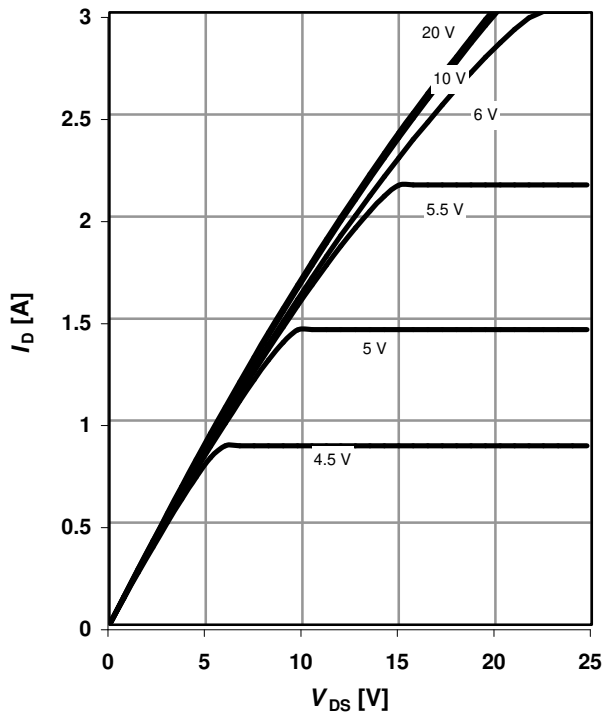

6 Typ. drain-source on-state resistance

$R_{DS(on)}=f(I_D); T_j=150\text{ °C}$

parameter: V_{GS}

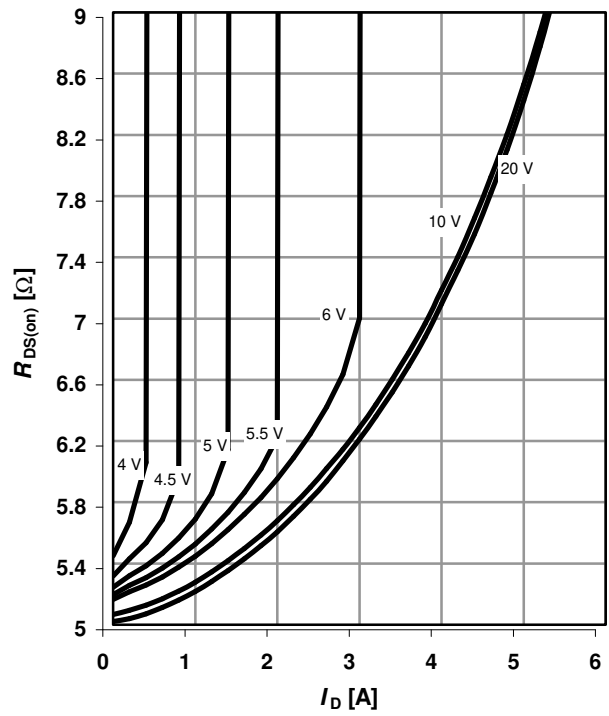

7 Drain-source on-state resistance

$R_{DS(on)}=f(T_j); I_D=1.2\text{ A}; V_{GS}=10\text{ V}$

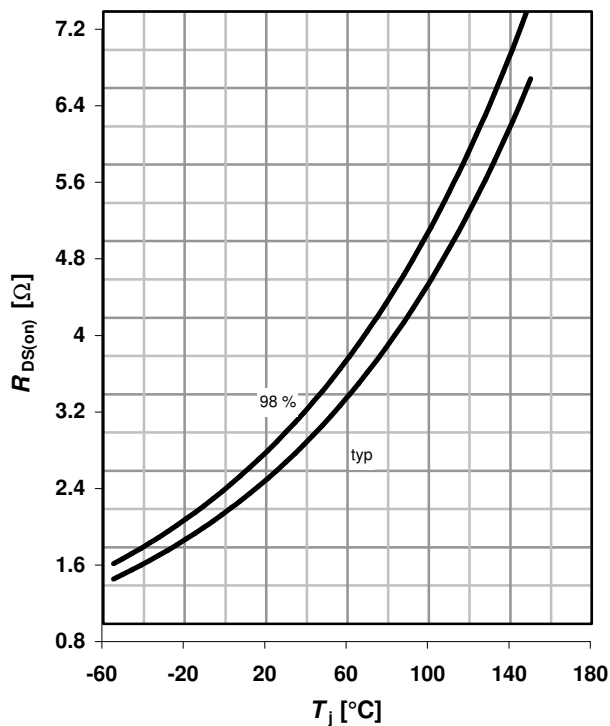

8 Typ. transfer characteristics

$I_D=f(V_{GS}); |V_{DS}|>2|I_D|R_{DS(on)max}; t_p=10\text{ }\mu\text{s}$

parameter: T_j

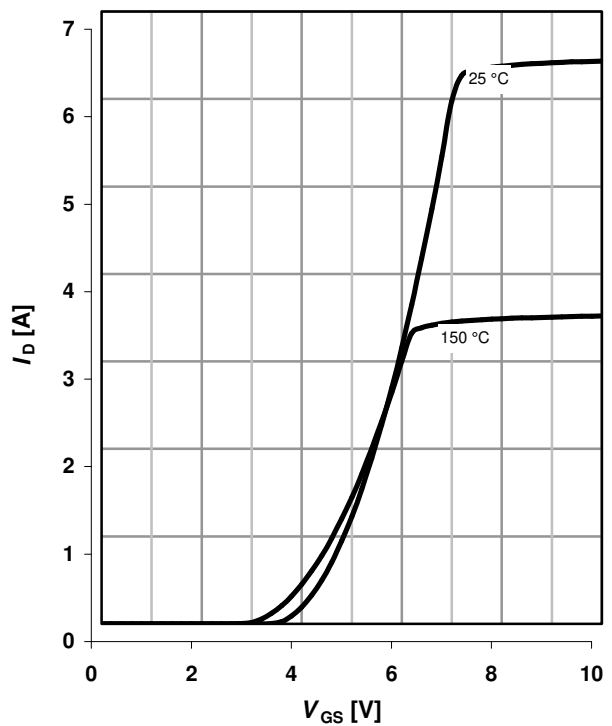

9 Typ. gate charge

$V_{GS}=f(Q_{gate}); I_D=2\text{ A}$ pulsed

parameter: V_{DD}

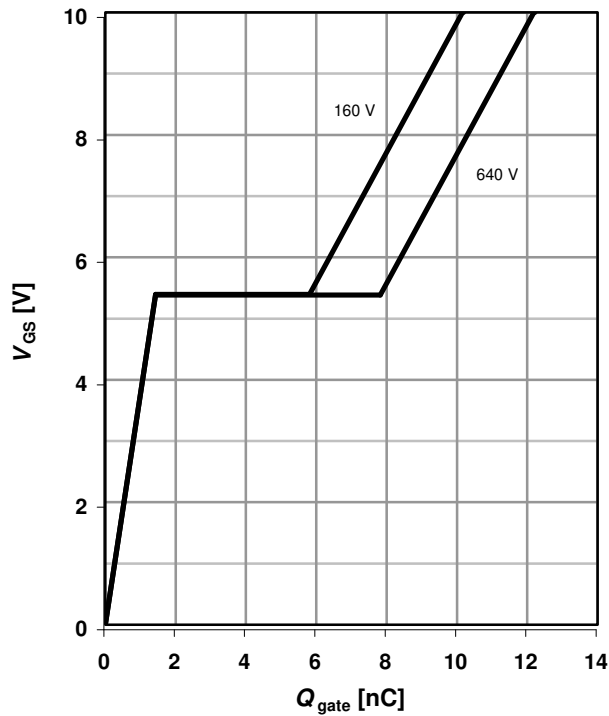

10 Forward characteristics of reverse diode

$I_F=f(V_{SD}); t_p=10\ \mu s$

parameter: T_j

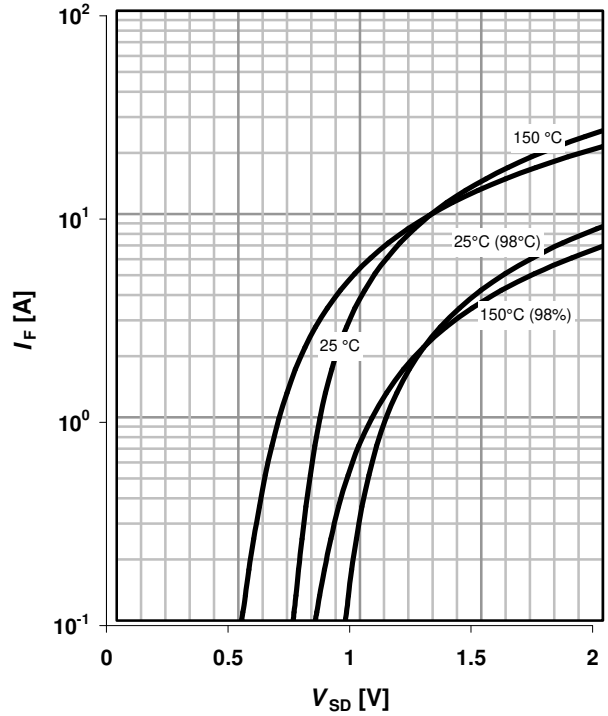

11 Avalanche energy

$E_{AS}=f(T_j); I_D=1\text{ A}; V_{DD}=50\text{ V}$

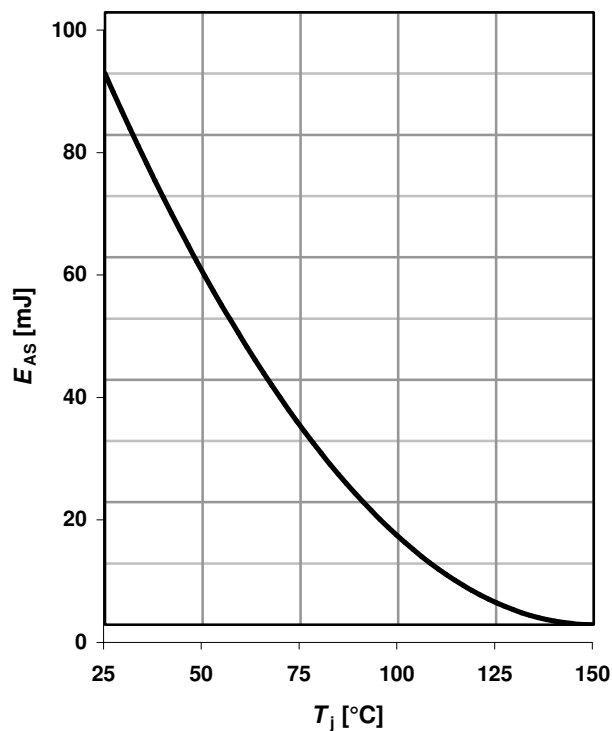

12 Drain-source breakdown voltage

$V_{BR(DSS)}=f(T_j); I_D=0.25\text{ mA}$

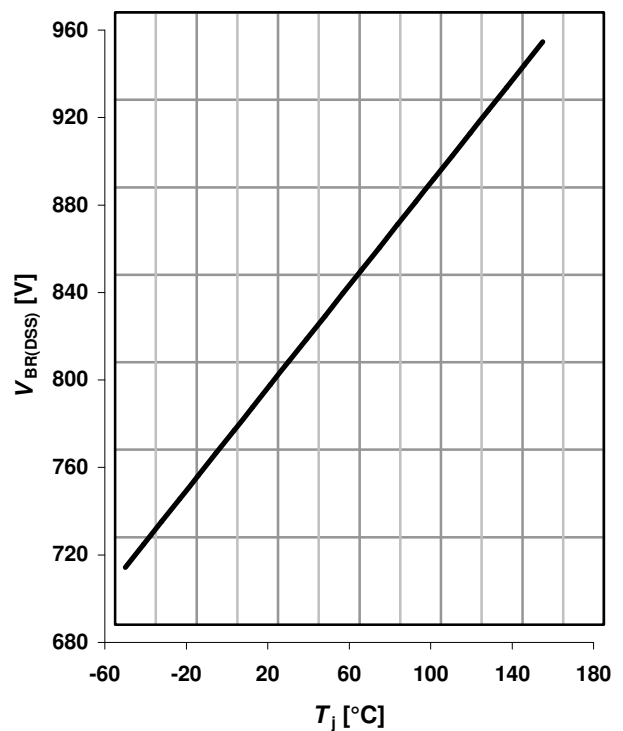

13 Typ. capacitances

$C=f(V_{DS}); V_{GS}=0\text{ V}; f=1\text{ MHz}$

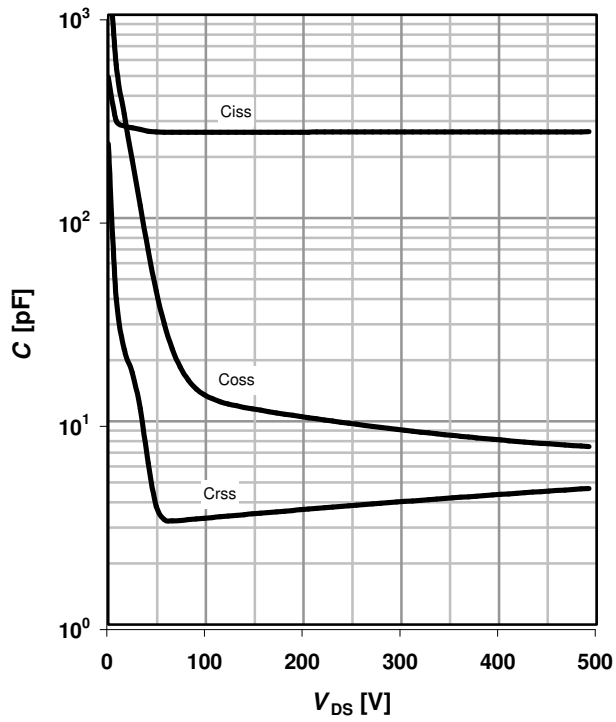

14 Typ. Coss stored energy

$E_{oss}=f(V_{DS})$

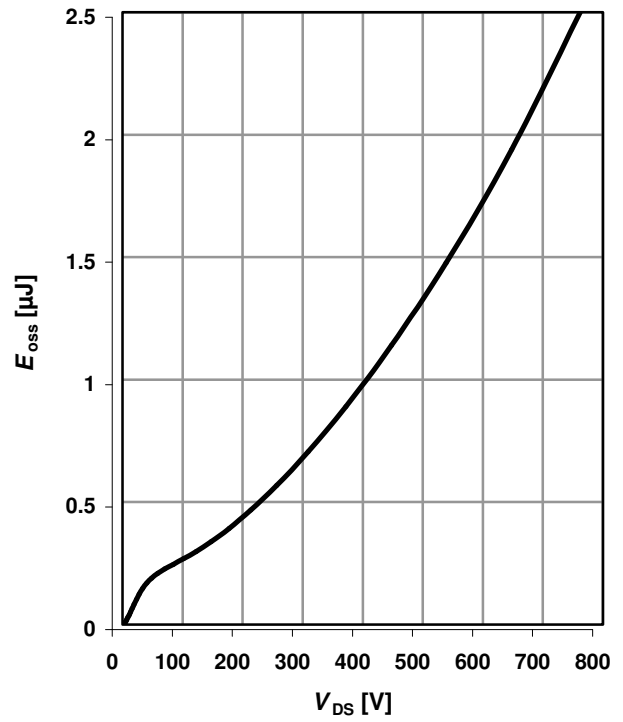

Definition of diode switching characteristics



PG-TO220-3: Outline

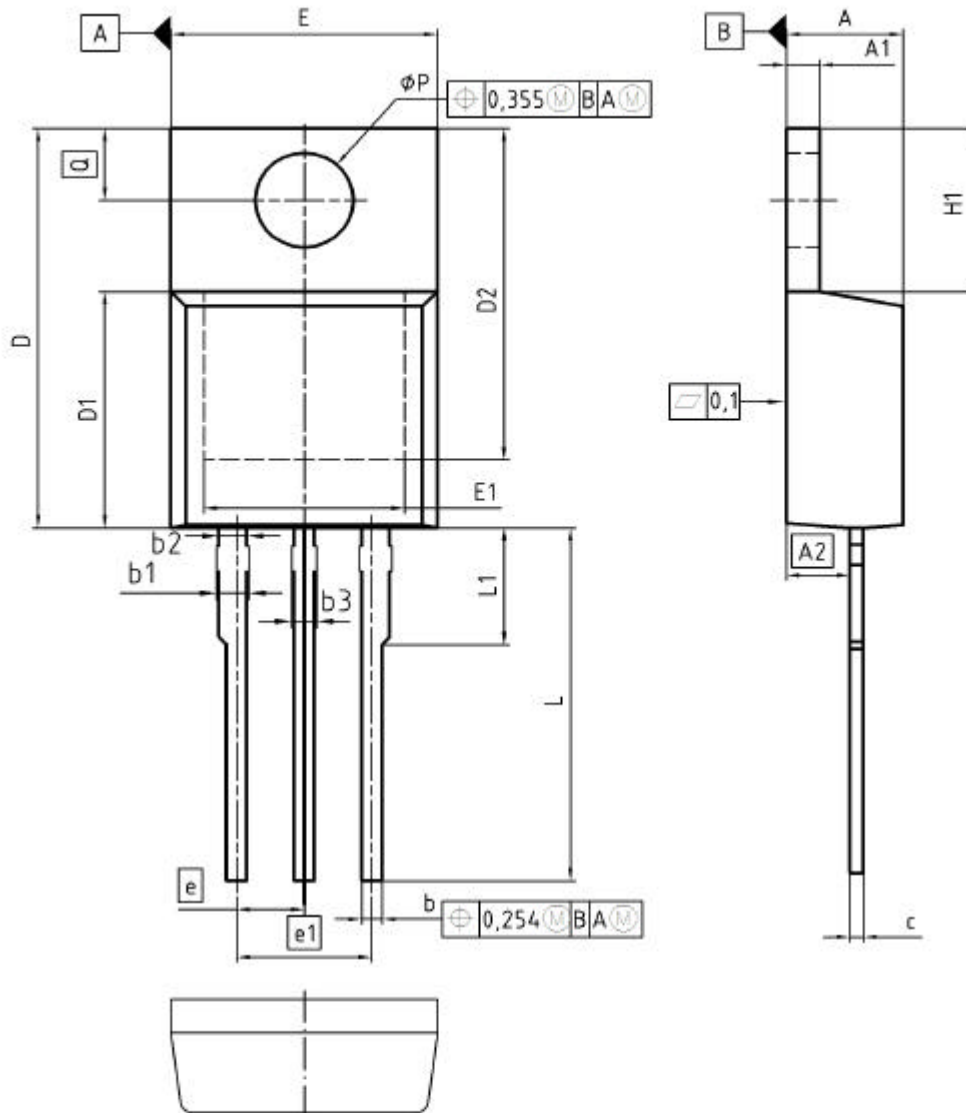

DIM	MILLIMETERS		INCHES	
	MIN	MAX	MIN	MAX
A	4.30	4.57	0.169	0.180
A1	1.17	1.40	0.046	0.055
A2	2.15	2.72	0.085	0.107
b	0.65	0.86	0.026	0.034
b1	0.95	1.40	0.037	0.055
b2	0.95	1.15	0.037	0.045
b3	0.65	1.15	0.026	0.045
c	0.33	0.60	0.013	0.024
D	14.81	15.95	0.583	0.628
D1	8.51	9.45	0.335	0.372
D2	12.19	13.10	0.480	0.516
E	9.70	10.36	0.382	0.408
E1	6.50	8.60	0.256	0.339
e	2.54		0.100	
e1	5.08		0.200	
N	3		3	
H1	5.90	6.90	0.232	0.272
L	13.00	14.00	0.512	0.551
L1	-	4.80	-	0.189
ϕP	3.60	3.89	0.142	0.153
Q	2.60	3.00	0.102	0.118

DOCUMENT NO.
Z8B00003318

SCALE

EUROPEAN PROJECTION

ISSUE DATE
23-08-2007

REVISION
05

Published by**Infineon Technologies AG****81726 Munich, Germany****© 2008 Infineon Technologies AG****All Rights Reserved.****Legal Disclaimer**

The information given in this document shall in no event be regarded as a guarantee of conditions or characteristics. With respect to any examples or hints given herein, any typical values stated herein and/or any information regarding the application of the device, Infineon Technologies hereby disclaims any and all warranties and liabilities of any kind, including without limitation, warranties of non-infringement of intellectual property rights of any third party.

Information

For further information on technology, delivery terms and conditions and prices, please [contact the nearest Infineon Technologies Office \(www.infineon.com\)](http://www.infineon.com).

Warnings

Due to technical requirements, components may contain dangerous substances. For information on the types in question, please contact the nearest Infineon Technologies Office.

Infineon Technologies components may be used in life-support devices or systems only with the express written approval of Infineon Technologies, if a failure of such components can reasonably be expected to cause the failure of that life-support device or system or to affect the safety or effectiveness of that device or system. Life support devices or systems are intended to be implanted in the human body or to support and/or maintain and sustain and/or protect human life. If they fail, it is reasonable to assume that the health of the user or other persons may be endangered.