

# TrenchMV™ Power MOSFET

## IXTV 280N055T IXTV 280N055TS

$$V_{DSS} = 55 \text{ V}$$

$$I_{D25} = 280 \text{ A}$$

$$R_{DS(on)} \leq 3.2 \text{ m}\Omega$$

N-Channel Enhancement Mode  
Avalanche Rated



Symbol	Test Conditions	Maximum Ratings	
$V_{DSS}$	$T_J = 25^\circ\text{C to } 175^\circ\text{C}$	55	V
$V_{DGR}$	$T_J = 25^\circ\text{C to } 175^\circ\text{C}; R_{GS} = 1 \text{ M}\Omega$	55	V
$V_{GSM}$	Transient	$\pm 20$	V
$I_{D25}$	$T_C = 25^\circ\text{C}$	280	A
$I_{LRMS}$	Lead Current Limit, RMS	75	A
$I_{DM}$	$T_C = 25^\circ\text{C}$ , pulse width limited by $T_{JM}$	600	A
$I_{AR}$	$T_C = 25^\circ\text{C}$	40	A
$E_{AS}$	$T_C = 25^\circ\text{C}$	1.5	J
$dv/dt$	$I_S \leq I_{DM}$ , $di/dt \leq 100 \text{ A}/\mu\text{s}$ , $V_{DD} \leq V_{DSS}$ $T_J \leq 175^\circ\text{C}$ , $R_G = 3.3 \Omega$	3	V/ns
$P_D$	$T_C = 25^\circ\text{C}$	550	W
$T_J$		-55 ... +175	$^\circ\text{C}$
$T_{JM}$		175	$^\circ\text{C}$
$T_{stg}$		-55 ... +175	$^\circ\text{C}$
$T_L$	1.6 mm (0.062 in.) from case for 10 s	300	$^\circ\text{C}$
$T_{SOLD}$	Plastic body for 10 seconds	260	$^\circ\text{C}$
$F_C$	Mounting force (PLUS220)	11...65 / 2.5...15	N/lb.
<b>Weight</b>		3	g

### PLUS220 (IXTV)

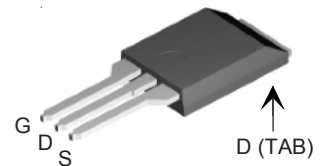

### PLUS220SMD (IXTV\_S)

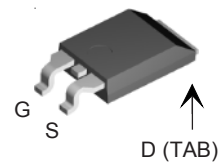

G = Gate      D = Drain  
S = Source      TAB = Drain

### Features

- Ultra-low On Resistance
- Unclamped Inductive Switching (UIS) rated
- Low package inductance
  - easy to drive and to protect
- 175 °C Operating Temperature

### Advantages

- Easy to mount
- Space savings
- High power density

### Applications

- Automotive
  - Motor Drives
  - High Side Switch
  - 12V Battery
  - ABS Systems
- DC/DC Converters and Off-line UPS
- Primary- Side Switch
- High Current Switching Applications

Symbol	Test Conditions ( $T_J = 25^\circ\text{C}$ unless otherwise specified)	Characteristic Values		
		Min.	Typ.	Max.
$BV_{DSS}$	$V_{GS} = 0 \text{ V}$ , $I_D = 250 \mu\text{A}$	55		V
$V_{GS(th)}$	$V_{DS} = V_{GS}$ , $I_D = 250 \mu\text{A}$	2.0		4.0 V
$I_{GSS}$	$V_{GS} = \pm 20 \text{ V}$ , $V_{DS} = 0 \text{ V}$			$\pm 200 \text{ nA}$
$I_{DSS}$	$V_{DS} = V_{DSS}$ $V_{GS} = 0 \text{ V}$ $T_J = 150^\circ\text{C}$			5 $\mu\text{A}$ 250 $\mu\text{A}$
$R_{DS(on)}$	$V_{GS} = 10 \text{ V}$ , $I_D = 50 \text{ A}$ , Notes 1, 2	2.6	3.2	m $\Omega$

Symbol	Test Conditions ( $T_J = 25^\circ\text{C}$ unless otherwise specified)	Characteristic Values		
		Min.	Typ.	Max.
$g_{fs}$	$V_{DS} = 10\text{ V}; I_D = 60\text{ A}$ , Note 1	75	118	S
$C_{iss}$	$V_{GS} = 0\text{ V}, V_{DS} = 25\text{ V}, f = 1\text{ MHz}$		9800	pF
$C_{oss}$			1450	pF
$C_{rss}$			320	pF
$t_{d(on)}$	$V_{GS} = 10\text{ V}, V_{DS} = 0.5 V_{DSS}, I_D = 50\text{ A}$ $R_G = 3.3\ \Omega$ (External)		32	ns
$t_r$			55	ns
$t_{d(off)}$			49	ns
$t_f$			37	ns
$Q_{g(on)}$	$V_{GS} = 10\text{ V}, V_{DS} = 0.5 V_{DSS}, I_D = 25\text{ A}$		200	nC
$Q_{gs}$			50	nC
$Q_{gd}$			50	nC
$R_{thJC}$	PLUS220			$0.27^\circ\text{C/W}$
$R_{thCS}$			.25	$^\circ\text{C/W}$

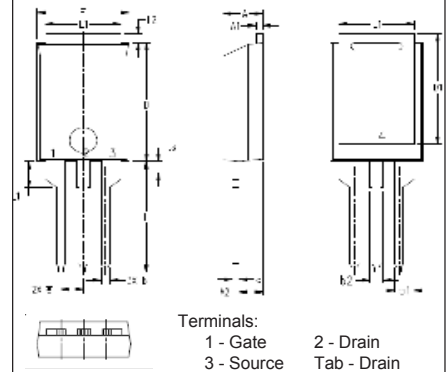
**PLUS220 (IXTV) Outline**

SYM	INCHES		MILLIMETER	
	MIN	MAX	MIN	MAX
A	.169	.185	4.30	4.70
A1	.028	.035	0.70	0.90
A2	.098	.118	2.50	3.00
b	.035	.047	0.90	1.20
b1	.080	.095	2.03	2.41
b2	.054	.064	1.37	1.63
c	.028	.035	0.70	0.90
D	.551	.591	14.00	15.00
D1	.512	.539	13.00	13.70
E	.394	.433	10.00	11.00
E1	.331	.346	8.40	8.80
e	.100 BSC		2.54 BSC	
L	.512	.551	13.00	14.00
L1	.118	.138	3.00	3.50
L2	.035	.051	0.90	1.30
L3	.047	.059	1.20	1.50

**Source-Drain Diode**

Symbol	Test Conditions ( $T_J = 25^\circ\text{C}$ unless otherwise specified)	Characteristic Values		
		Min.	Typ.	Max.
$I_s$	$V_{GS} = 0\text{ V}$			280 A
$I_{SM}$	Pulse width limited by $T_{JM}$			600 A
$V_{SD}$	$I_F = 50\text{ A}, V_{GS} = 0\text{ V}$ , Note 1			1.0 V
$t_{rr}$	$I_F = 50\text{ A}, -di/dt = 100\text{ A}/\mu\text{s}$ $V_R = 25\text{ V}, V_{GS} = 0\text{ V}$		70	ns

- Note 1. Pulse test,  $t \leq 300\ \mu\text{s}$ , duty cycle  $d \leq 2\%$ ;  
 2. On through-hole packages,  $R_{DS(on)}$  Kelvin test contact location is 5 mm or less from the package body.

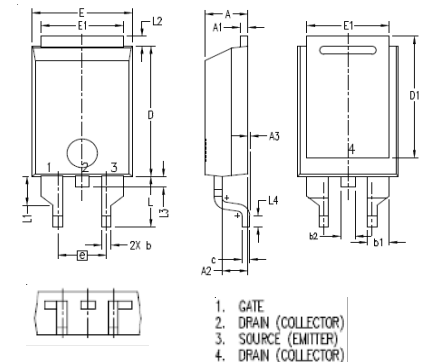
**PLUS220SMD (IXTV\_S) Outline**

SYM	INCHES		MILLIMETER	
	MIN	MAX	MIN	MAX
A	.169	.185	4.30	4.70
A1	.028	.035	0.70	0.90
A2	.098	.118	2.50	3.00
A3	.000	.010	0.00	0.25
b	.035	.047	0.90	1.20
b1	.080	.095	2.03	2.41
b2	.054	.064	1.37	1.63
c	.028	.035	0.70	0.90
D	.551	.591	14.00	15.00
D1	.512	.539	13.00	13.70
E	.394	.433	10.00	11.00
E1	.331	.346	8.40	8.80
e	.200 BSC		5.08 BSC	
L	.209	.228	5.30	5.80
L1	.118	.138	3.00	3.50
L2	.035	.051	0.90	1.30
L3	.047	.059	1.20	1.50
L4	.039	.059	1.00	1.50

**PRELIMINARY TECHNICAL INFORMATION**

The product presented herein is under development. The Technical Specifications offered are derived from data gathered during objective characterizations of preliminary engineering lots; but also may yet contain some information supplied during a pre-production design evaluation. IXYS reserves the right to change limits, test conditions, and dimensions without notice.

IXYS reserves the right to change limits, test conditions, and dimensions.

IXYS MOSFETs and IGBTs are covered by one or more of the following U.S. patents:	4,835,592	4,931,844	5,049,961	5,237,481	6,162,665	6,404,065 B1	6,683,344	6,727,585	7,005,734 B2
	4,850,072	5,017,508	5,063,307	5,381,025	6,259,123 B1	6,534,343	6,710,405 B2	6,759,692	7,063,975 B2
	4,881,106	5,034,796	5,187,117	5,486,715	6,306,728 B1	6,583,505	6,710,463	6,771,478 B2	7,071,537

**Fig. 1. Output Characteristics @ 25°C**

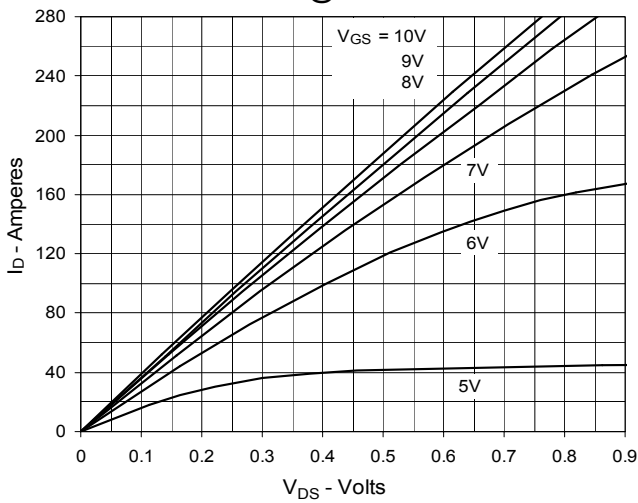

**Fig. 2. Extended Output Characteristics @ 25°C**

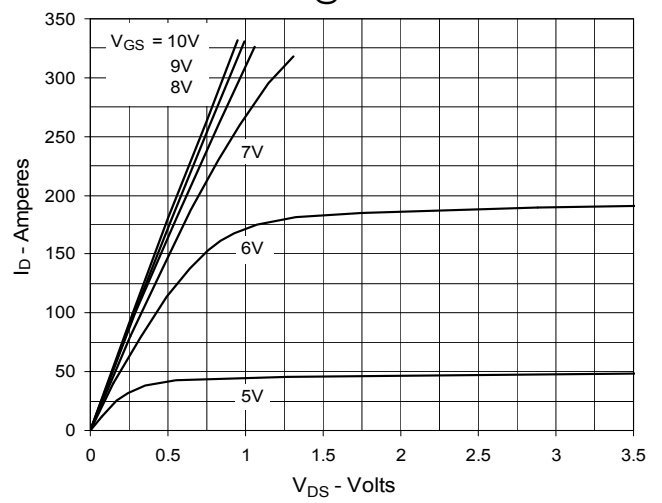

**Fig. 3. Output Characteristics @ 150°C**

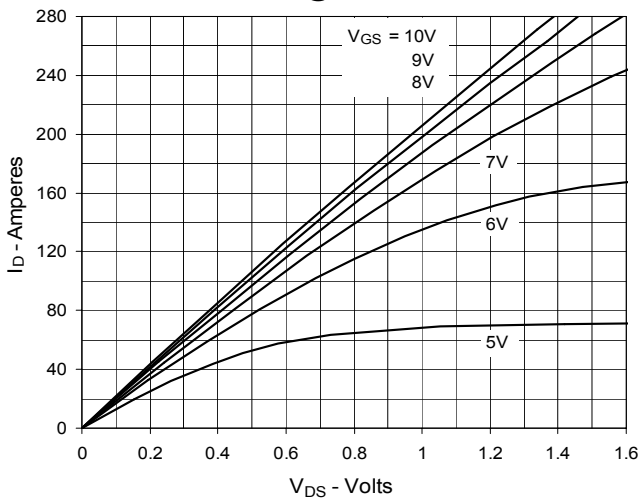

**Fig. 4.  $R_{DS(on)}$  Normalized to  $I_D = 140A$  Value vs. Junction Temperature**

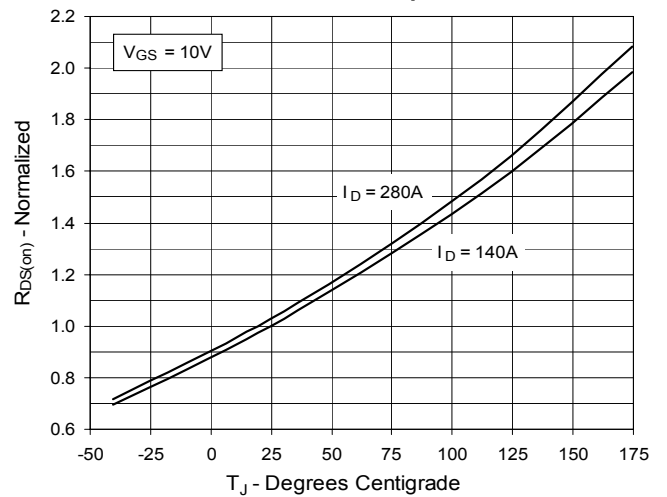

**Fig. 5.  $R_{DS(on)}$  Normalized to  $I_D = 140A$  Value vs. Drain Current**

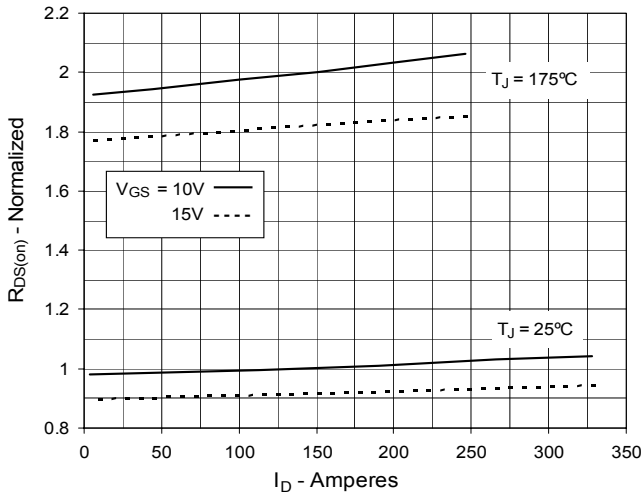

**Fig. 6. Drain Current vs. Case Temperature**

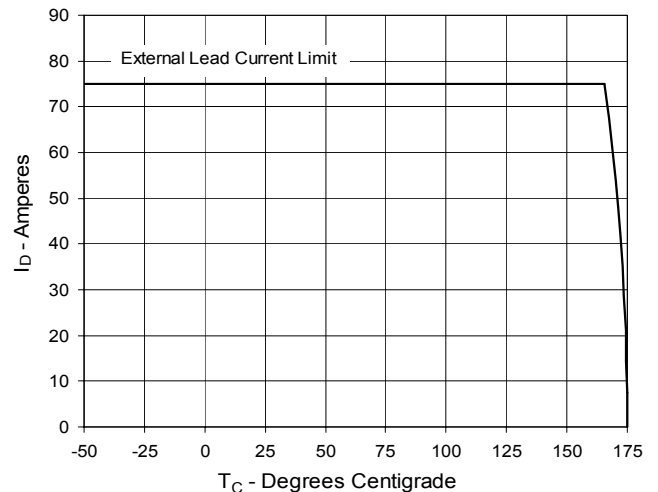

**Fig. 7. Input Admittance**

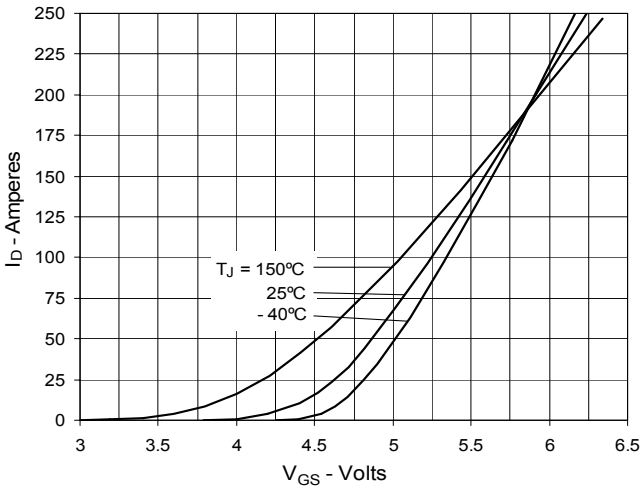

**Fig. 8. Transconductance**

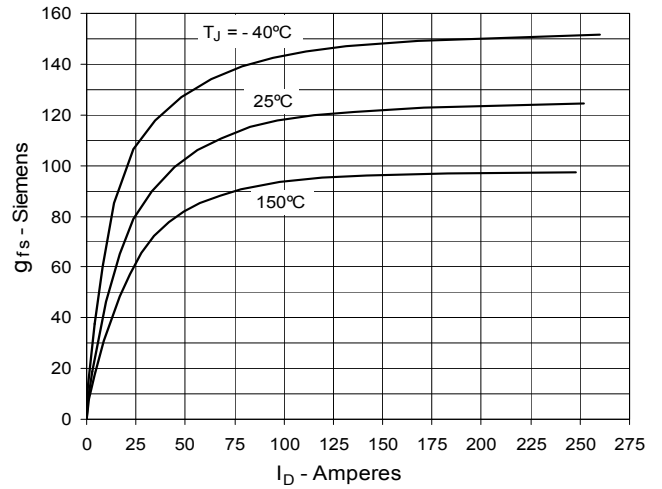

**Fig. 9. Forward Voltage Drop of Intrinsic Diode**

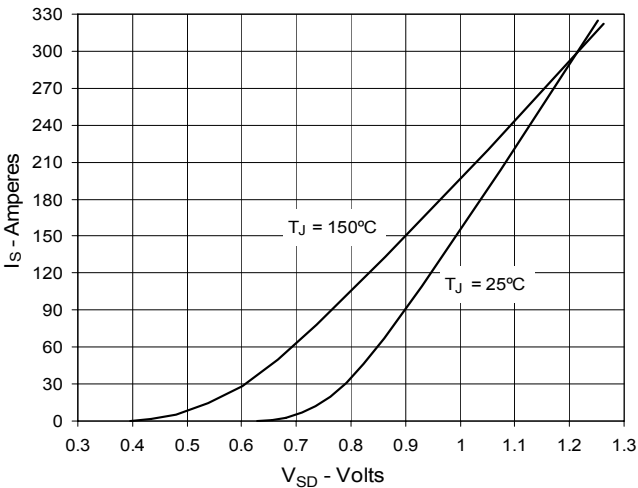

**Fig. 10. Gate Charge**

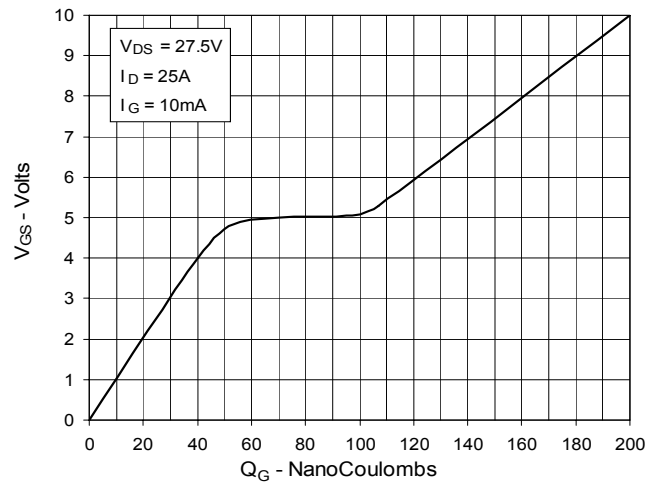

**Fig. 11. Capacitance**

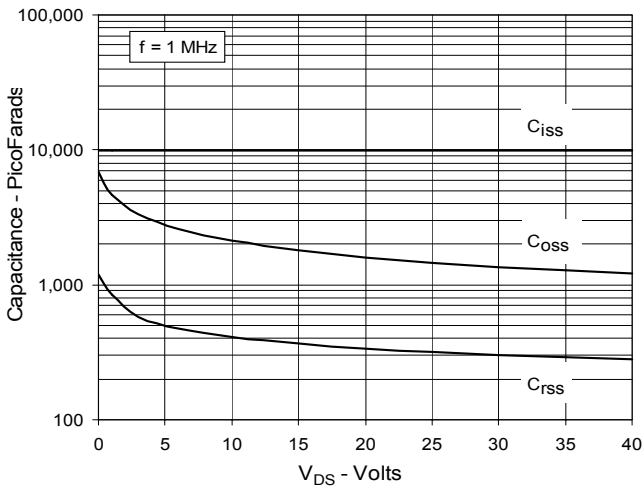

**Fig. 12. Maximum Transient Thermal Impedance**

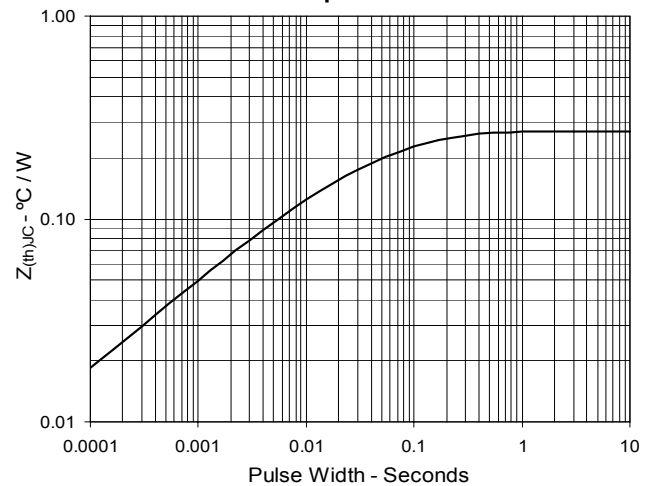

**Fig. 13. Resistive Turn-on Rise Time vs. Junction Temperature**

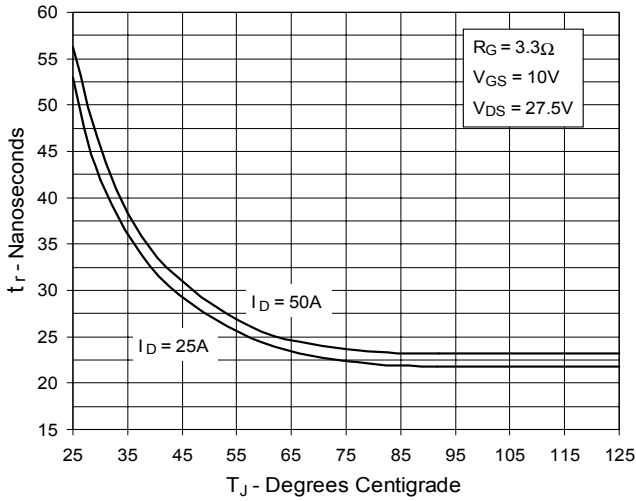

**Fig. 14. Resistive Turn-on Rise Time vs. Drain Current**

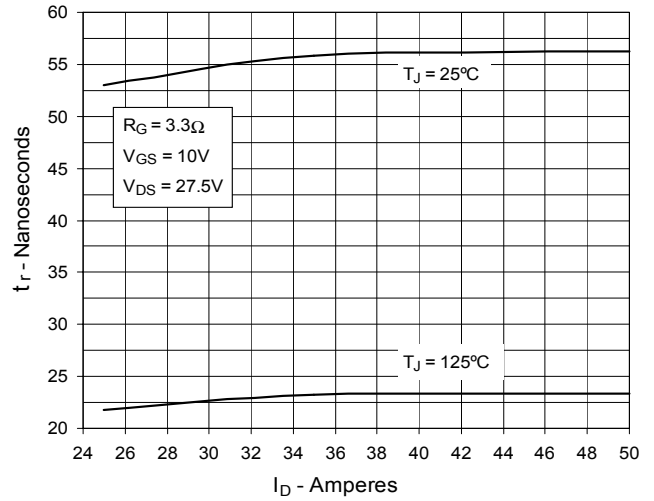

**Fig. 15. Resistive Turn-on Switching Times vs. Gate Resistance**

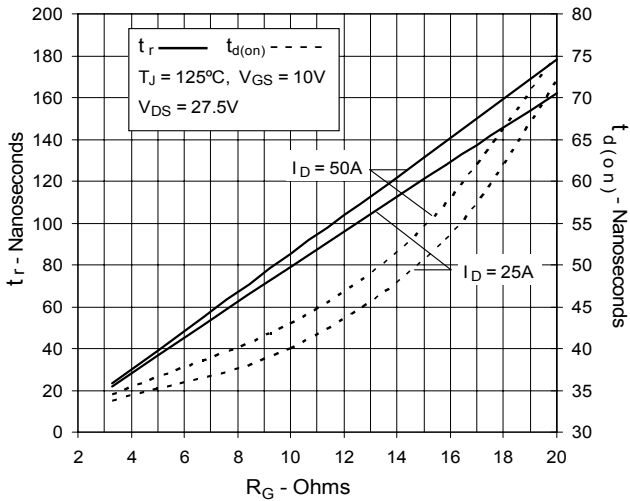

**Fig. 16. Resistive Turn-off Switching Times vs. Junction Temperature**

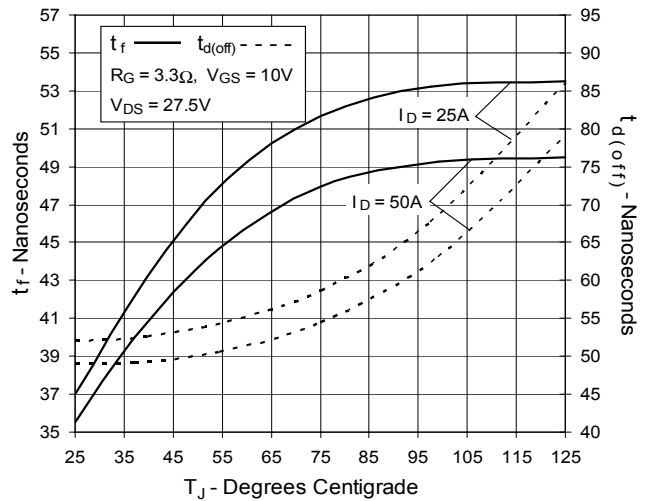

**Fig. 17. Resistive Turn-off Switching Times vs. Drain Current**

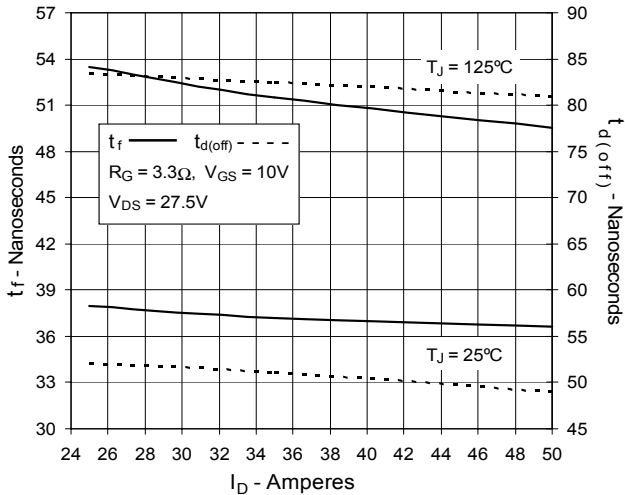

**Fig. 18. Resistive Turn-off Switching Times vs. Gate Resistance**

