



Is Now Part of



**ON Semiconductor®**

To learn more about ON Semiconductor, please visit our website at  
[www.onsemi.com](http://www.onsemi.com)

Please note: As part of the Fairchild Semiconductor integration, some of the Fairchild orderable part numbers will need to change in order to meet ON Semiconductor's system requirements. Since the ON Semiconductor product management systems do not have the ability to manage part nomenclature that utilizes an underscore (\_), the underscore (\_) in the Fairchild part numbers will be changed to a dash (-). This document may contain device numbers with an underscore (\_). Please check the ON Semiconductor website to verify the updated device numbers. The most current and up-to-date ordering information can be found at [www.onsemi.com](http://www.onsemi.com). Please email any questions regarding the system integration to [Fairchild\\_questions@onsemi.com](mailto:Fairchild_questions@onsemi.com).

ON Semiconductor and the ON Semiconductor logo are trademarks of Semiconductor Components Industries, LLC dba ON Semiconductor or its subsidiaries in the United States and/or other countries. ON Semiconductor owns the rights to a number of patents, trademarks, copyrights, trade secrets, and other intellectual property. A listing of ON Semiconductor's product/patent coverage may be accessed at [www.onsemi.com/site/pdf/Patent-Marking.pdf](http://www.onsemi.com/site/pdf/Patent-Marking.pdf). ON Semiconductor reserves the right to make changes without further notice to any products herein. ON Semiconductor makes no warranty, representation or guarantee regarding the suitability of its products for any particular purpose, nor does ON Semiconductor assume any liability arising out of the application or use of any product or circuit, and specifically disclaims any and all liability, including without limitation special, consequential or incidental damages. Buyer is responsible for its products and applications using ON Semiconductor products, including compliance with all laws, regulations and safety requirements or standards, regardless of any support or applications information provided by ON Semiconductor. "Typical" parameters which may be provided in ON Semiconductor data sheets and/or specifications can and do vary in different applications and actual performance may vary over time. All operating parameters, including "Typicals" must be validated for each customer application by customer's technical experts. ON Semiconductor does not convey any license under its patent rights nor the rights of others. ON Semiconductor products are not designed, intended, or authorized for use as a critical component in life support systems or any FDA Class 3 medical devices or medical devices with a same or similar classification in a foreign jurisdiction or any devices intended for implantation in the human body. Should Buyer purchase or use ON Semiconductor products for any such unintended or unauthorized application, Buyer shall indemnify and hold ON Semiconductor and its officers, employees, subsidiaries, affiliates, and distributors harmless against all claims, costs, damages, and expenses, and reasonable attorney fees arising out of, directly or indirectly, any claim of personal injury or death associated with such unintended or unauthorized use, even if such claim alleges that ON Semiconductor was negligent regarding the design or manufacture of the part. ON Semiconductor is an Equal Opportunity/Affirmative Action Employer. This literature is subject to all applicable copyright laws and is not for resale in any manner.



# FDMS3016DC

## N-Channel Dual Cool™ 56 PowerTrench® MOSFET

30 V, 49 A, 6.0 mΩ



### Features

- Dual Cool™ Top Side Cooling PQFN package
- Max  $r_{DS(on)}$  = 6.0 mΩ at  $V_{GS} = 10$  V,  $I_D = 12$  A
- Max  $r_{DS(on)}$  = 9.0 mΩ at  $V_{GS} = 4.5$  V,  $I_D = 10$  A
- High performance technology for extremely low  $r_{DS(on)}$
- RoHS Compliant

### General Description

This N-Channel MOSFET is produced using Fairchild Semiconductor's advanced PowerTrench® process. Advancements in both silicon and Dual Cool™ package technologies have been combined to offer the lowest  $r_{DS(on)}$  while maintaining excellent switching performance by extremely low Junction-to-Ambient thermal resistance.

### Applications

- Synchronous Rectifier for DC/DC Converters
- Telecom Secondary Side Rectification
- High End Server/Workstation

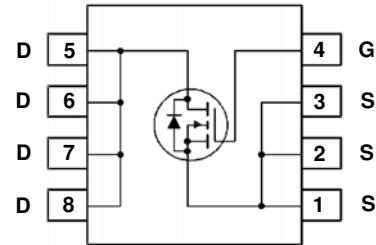
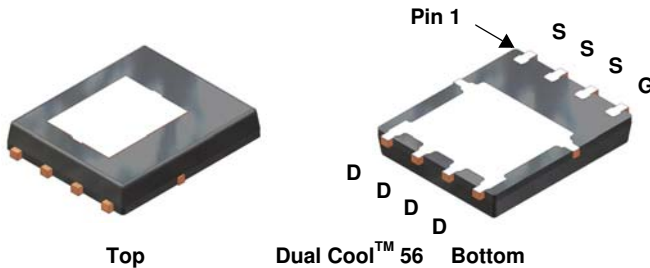

### MOSFET Maximum Ratings $T_A = 25^\circ\text{C}$ unless otherwise noted

| Symbol         | Parameter  | Rated       | Units            |
|----------------|--|-------------|------------------|
| $V_{DS}$       | Drain to Source Voltage  | 30          | V                |
| $V_{GS}$       | Gate to Source Voltage   | $\pm 20$    | V                |
| $I_D$          | Drain Current -Continuous (Package limited) $T_C = 25^\circ\text{C}$ | 49          | A                |
|                | -Continuous (Silicon limited) $T_C = 25^\circ\text{C}$               | 78          |                  |
|                | -Continuous $T_A = 25^\circ\text{C}$ (Note 1a)                       | 18          |                  |
|                | -Pulsed  | 200         |                  |
| $E_{AS}$       | Single Pulse Avalanche Energy (Note 3)                               | 72          | mJ               |
| dv/dt          | Peak Diode Recovery dv/dt (Note 4)                                   | 1.3         | V/ns             |
| $P_D$          | Power Dissipation $T_C = 25^\circ\text{C}$                           | 60          | W                |
|                | Power Dissipation $T_A = 25^\circ\text{C}$ (Note 1a)                 | 3.3         |                  |
| $T_J, T_{STG}$ | Operating and Storage Junction Temperature Range                     | -55 to +150 | $^\circ\text{C}$ |

### Thermal Characteristics

|                 |   |     |                           |
|-----------------|---|-----|---------------------------|
| $R_{\theta JC}$ | Thermal Resistance, Junction to Case (Top Source)   | 5.7 | $^\circ\text{C}/\text{W}$ |
| $R_{\theta JC}$ | Thermal Resistance, Junction to Case (Bottom Drain) | 2.1 |                           |
| $R_{\theta JA}$ | Thermal Resistance, Junction to Ambient (Note 1a)   | 38  |                           |
| $R_{\theta JA}$ | Thermal Resistance, Junction to Ambient (Note 1b)   | 81  |                           |
| $R_{\theta JA}$ | Thermal Resistance, Junction to Ambient (Note 1i)   | 16  |                           |
| $R_{\theta JA}$ | Thermal Resistance, Junction to Ambient (Note 1j)   | 23  |                           |
| $R_{\theta JA}$ | Thermal Resistance, Junction to Ambient (Note 1k)   | 11  |                           |

### Package Marking and Ordering Information

| Device Marking | Device     | Package       | Reel Size | Tape Width | Quantity   |
|----------------|------------|---------------|-----------|------------|------------|
| 3016           | FDMS3016DC | Dual Cool™ 56 | 13"       | 12 mm      | 3000 units |

FDMS3016DC N-Channel Dual Cool™ 56 PowerTrench® MOSFET

**Electrical Characteristics**  $T_J = 25\text{ }^\circ\text{C}$  unless otherwise noted

| Symbol | Parameter | Test Conditions | Min | Typ | Max | Units |
|--------|-----------|-----------------|-----|-----|-----|-------|
|--------|-----------|-----------------|-----|-----|-----|-------|

**Off Characteristics**

|                                      |   |   |    |    |           |               |
|--------------------------------------|---|---|----|----|-----------|---------------|
| $BV_{DSS}$                           | Drain to Source Breakdown Voltage         | $I_D = 250\ \mu\text{A}, V_{GS} = 0\ \text{V}$                      | 30 |    |           | V             |
| $\frac{\Delta BV_{DSS}}{\Delta T_J}$ | Breakdown Voltage Temperature Coefficient | $I_D = 250\ \mu\text{A}$ , referenced to $25\text{ }^\circ\text{C}$ |    | 17 |           | mV/°C         |
| $I_{DSS}$                            | Zero Gate Voltage Drain Current           | $V_{DS} = 24\ \text{V}, V_{GS} = 0\ \text{V}$                       |    |    | 1         | $\mu\text{A}$ |
| $I_{GSS}$                            | Gate to Source Leakage Current            | $V_{GS} = \pm 20\ \text{V}, V_{DS} = 0\ \text{V}$                   |    |    | $\pm 100$ | nA            |

**On Characteristics**

|  |  |  |     |     |     |            |
|--|--|--|-----|-----|-----|------------|
| $V_{GS(th)}$                           | Gate to Source Threshold Voltage                         | $V_{GS} = V_{DS}, I_D = 250\ \mu\text{A}$                                    | 1.0 | 1.9 | 3.0 | V          |
| $\frac{\Delta V_{GS(th)}}{\Delta T_J}$ | Gate to Source Threshold Voltage Temperature Coefficient | $I_D = 250\ \mu\text{A}$ , referenced to $25\text{ }^\circ\text{C}$          |     | -6  |     | mV/°C      |
| $r_{DS(on)}$                           | Static Drain to Source On Resistance                     | $V_{GS} = 10\ \text{V}, I_D = 12\ \text{A}$                                  |     | 5.0 | 6.0 | m $\Omega$ |
|  |  | $V_{GS} = 4.5\ \text{V}, I_D = 10\ \text{A}$                                 |     | 7.0 | 9.0 |            |
|  |  | $V_{GS} = 10\ \text{V}, I_D = 12\ \text{A}, T_J = 125\text{ }^\circ\text{C}$ |     | 7.5 | 9.4 |            |
| $g_{FS}$                               | Forward Transconductance                                 | $V_{DS} = 5\ \text{V}, I_D = 12\ \text{A}$                                   |     | 44  |     | S          |

**Dynamic Characteristics**

|           |                              |   |  |      |      |          |
|-----------|------------------------------|---|--|------|------|----------|
| $C_{iss}$ | Input Capacitance            | $V_{DS} = 15\ \text{V}, V_{GS} = 0\ \text{V},$<br>$f = 1\ \text{MHz}$ |  | 1038 | 1385 | pF       |
| $C_{oss}$ | Output Capacitance           |   |  | 513  | 685  | pF       |
| $C_{rss}$ | Reverse Transfer Capacitance |   |  | 87   | 135  | pF       |
| $R_g$     | Gate Resistance              |   |  | 0.9  |      | $\Omega$ |

**Switching Characteristics**

|              |                               |  |  |    |     |      |    |
|--------------|-------------------------------|--|--|----|-----|------|----|
| $t_{d(on)}$  | Turn-On Delay Time            | $V_{DD} = 15\ \text{V}, I_D = 12\ \text{A},$<br>$V_{GS} = 10\ \text{V}, R_{GEN} = 6\ \Omega$ |  | 9  | 18  | ns   |    |
| $t_r$        | Rise Time                     |  |  | 3  | 10  | ns   |    |
| $t_{d(off)}$ | Turn-Off Delay Time           |  |  | 19 | 35  | ns   |    |
| $t_f$        | Fall Time                     |  |  | 2  | 10  | ns   |    |
| $Q_g$        | Total Gate Charge             |  | $V_{GS} = 0\ \text{V to } 10\ \text{V}$          |    | 16  | 23   | nC |
| $Q_g$        | Total Gate Charge             | $V_{GS} = 0\ \text{V to } 4.5\ \text{V}$   | $V_{DD} = 15\ \text{V},$<br>$I_D = 12\ \text{A}$ |    | 7.6 | 10.6 | nC |
| $Q_{gs}$     | Gate to Source Gate Charge    |  |  |    | 3   |      | nC |
| $Q_{gd}$     | Gate to Drain "Miller" Charge |  |  |    | 2.5 |      | nC |

**Drain-Source Diode Characteristics**

|          |                                       |   |  |      |     |    |
|----------|---------------------------------------|---|--|------|-----|----|
| $V_{SD}$ | Source to Drain Diode Forward Voltage | $V_{GS} = 0\ \text{V}, I_S = 12\ \text{A}$ (Note 2)     |  | 0.82 | 1.3 | V  |
|          |                                       | $V_{GS} = 0\ \text{V}, I_S = 1.9\ \text{A}$ (Note 2)    |  | 0.73 | 1.2 |    |
| $t_{rr}$ | Reverse Recovery Time                 | $I_F = 12\ \text{A}, di/dt = 100\ \text{A}/\mu\text{s}$ |  | 25   | 45  | ns |
| $Q_{rr}$ | Reverse Recovery Charge               |   |  | 9    | 18  | nC |

## Thermal Characteristics

|                 |   |     |                             |
|-----------------|---|-----|-----------------------------|
| $R_{\theta JC}$ | Thermal Resistance, Junction to Case (Top Source)   | 5.7 | $^{\circ}\text{C}/\text{W}$ |
| $R_{\theta JC}$ | Thermal Resistance, Junction to Case (Bottom Drain) | 2.1 |                             |
| $R_{\theta JA}$ | Thermal Resistance, Junction to Ambient (Note 1a)   | 38  |                             |
| $R_{\theta JA}$ | Thermal Resistance, Junction to Ambient (Note 1b)   | 81  |                             |
| $R_{\theta JA}$ | Thermal Resistance, Junction to Ambient (Note 1c)   | 27  |                             |
| $R_{\theta JA}$ | Thermal Resistance, Junction to Ambient (Note 1d)   | 34  |                             |
| $R_{\theta JA}$ | Thermal Resistance, Junction to Ambient (Note 1e)   | 16  |                             |
| $R_{\theta JA}$ | Thermal Resistance, Junction to Ambient (Note 1f)   | 19  |                             |
| $R_{\theta JA}$ | Thermal Resistance, Junction to Ambient (Note 1g)   | 26  |                             |
| $R_{\theta JA}$ | Thermal Resistance, Junction to Ambient (Note 1h)   | 61  |                             |
| $R_{\theta JA}$ | Thermal Resistance, Junction to Ambient (Note 1i)   | 16  |                             |
| $R_{\theta JA}$ | Thermal Resistance, Junction to Ambient (Note 1j)   | 23  |                             |
| $R_{\theta JA}$ | Thermal Resistance, Junction to Ambient (Note 1k)   | 11  |                             |
| $R_{\theta JA}$ | Thermal Resistance, Junction to Ambient (Note 1l)   | 13  |                             |

### NOTES:

1.  $R_{\theta JA}$  is determined with the device mounted on a FR-4 board using a specified pad of 2 oz copper as shown below.  $R_{\theta JC}$  is guaranteed by design while  $R_{\theta CA}$  is determined by the user's board design.

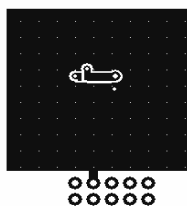

a. 38  $^{\circ}\text{C}/\text{W}$  when mounted on a 1 in<sup>2</sup> pad of 2 oz copper

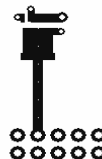

b. 81  $^{\circ}\text{C}/\text{W}$  when mounted on a minimum pad of 2 oz copper

- c. Still air, 20.9x10.4x12.7mm Aluminum Heat Sink, 1 in<sup>2</sup> pad of 2 oz copper
- d. Still air, 20.9x10.4x12.7mm Aluminum Heat Sink, minimum pad of 2 oz copper
- e. Still air, 45.2x41.4x11.7mm Aavid Thermalloy Part # 10-L41B-11 Heat Sink, 1 in<sup>2</sup> pad of 2 oz copper
- f. Still air, 45.2x41.4x11.7mm Aavid Thermalloy Part # 10-L41B-11 Heat Sink, minimum pad of 2 oz copper
- g. 200FPM Airflow, No Heat Sink, 1 in<sup>2</sup> pad of 2 oz copper
- h. 200FPM Airflow, No Heat Sink, minimum pad of 2 oz copper
- i. 200FPM Airflow, 20.9x10.4x12.7mm Aluminum Heat Sink, 1 in<sup>2</sup> pad of 2 oz copper
- j. 200FPM Airflow, 20.9x10.4x12.7mm Aluminum Heat Sink, minimum pad of 2 oz copper
- k. 200FPM Airflow, 45.2x41.4x11.7mm Aavid Thermalloy Part # 10-L41B-11 Heat Sink, 1 in<sup>2</sup> pad of 2 oz copper
- l. 200FPM Airflow, 45.2x41.4x11.7mm Aavid Thermalloy Part # 10-L41B-11 Heat Sink, minimum pad of 2 oz copper

2. Pulse Test: Pulse Width < 300  $\mu\text{s}$ , Duty cycle < 2.0%.

3.  $E_{AS}$  of 72 mJ is based on starting  $T_J = 25^{\circ}\text{C}$ ,  $L = 1\text{ mH}$ ,  $I_{AS} = 12\text{ A}$ ,  $V_{DD} = 27\text{ V}$ ,  $V_{GS} = 10\text{ V}$ .

4.  $I_{SD} \leq 12\text{ A}$ ,  $di/dt \leq 100\text{ A}/\mu\text{s}$ ,  $V_{DD} \leq BV_{DSS}$ , Starting  $T_J = 25^{\circ}\text{C}$ .

**Typical Characteristics**  $T_J = 25^\circ\text{C}$  unless otherwise noted

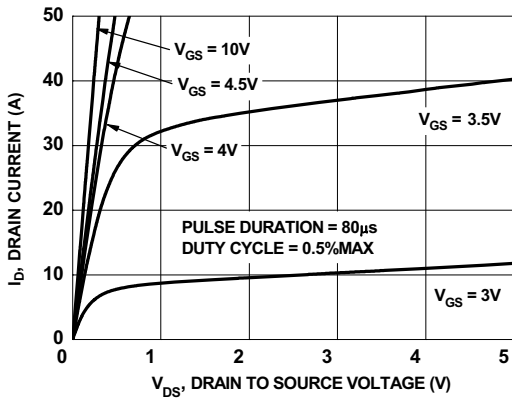

Figure 1. On-Region Characteristics

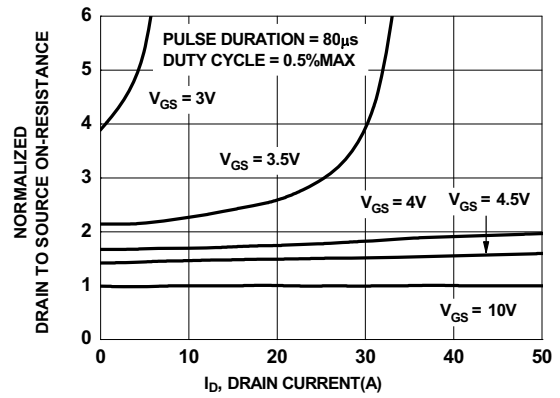

Figure 2. Normalized On-Resistance vs Drain Current and Gate Voltage

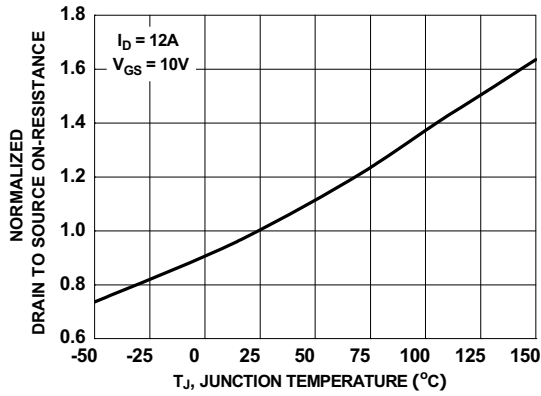

Figure 3. Normalized On-Resistance vs Junction Temperature

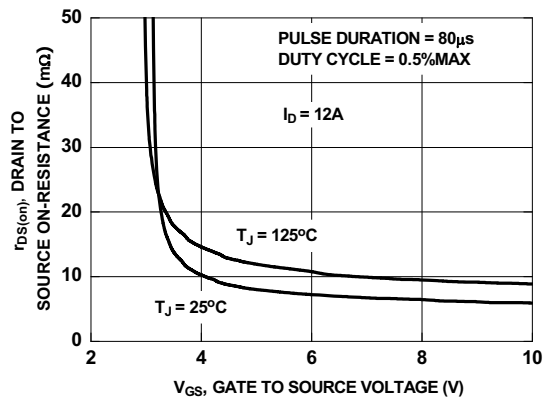

Figure 4. On-Resistance vs Gate to Source Voltage

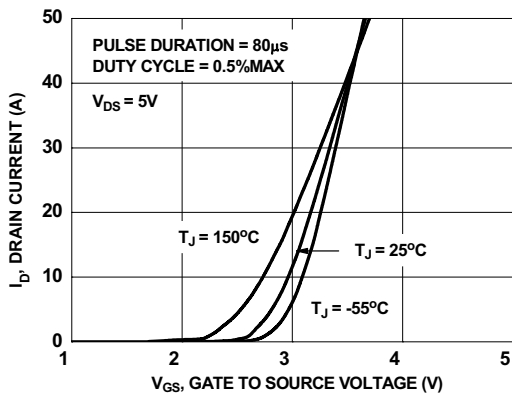

Figure 5. Transfer Characteristics

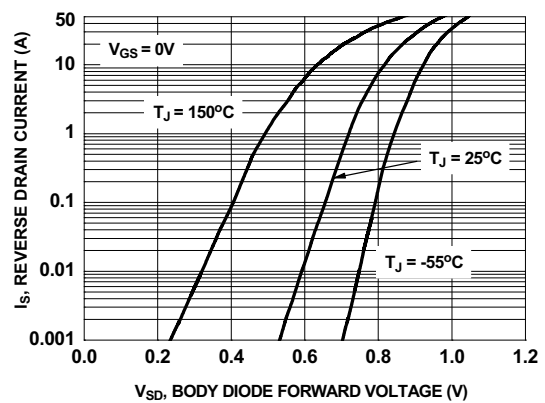

Figure 6. Source to Drain Diode Forward Voltage vs Source Current

**Typical Characteristics**  $T_J = 25^\circ\text{C}$  unless otherwise noted

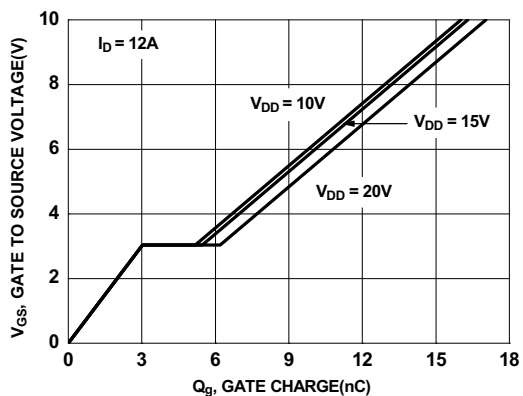

Figure 7. Gate Charge Characteristics

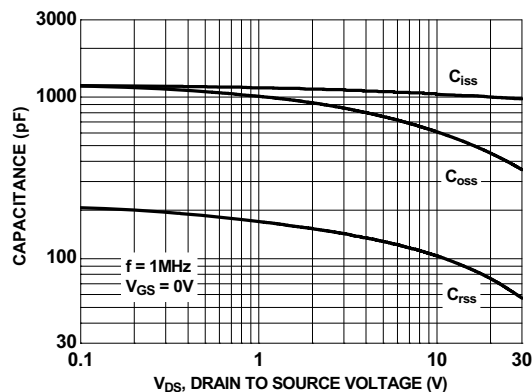

Figure 8. Capacitance vs Drain to Source Voltage

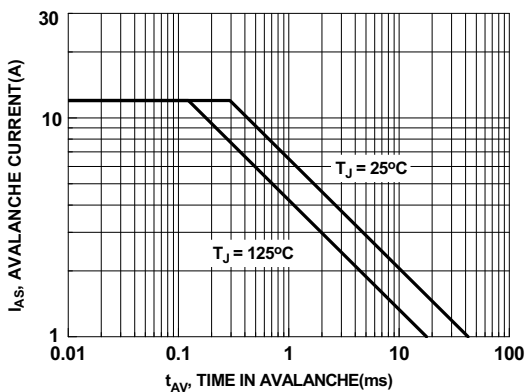

Figure 9. Unclamped Inductive Switching Capability

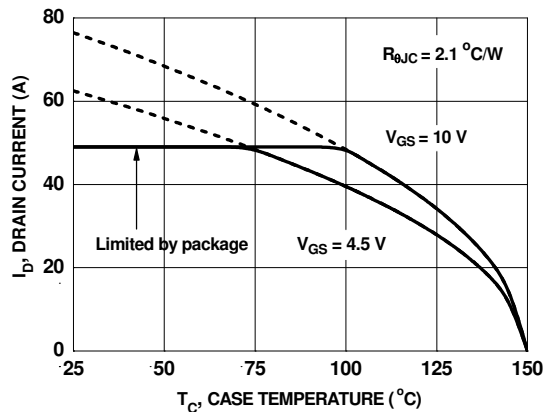

Figure 10. Maximum Continuous Drain Current vs Case Temperature

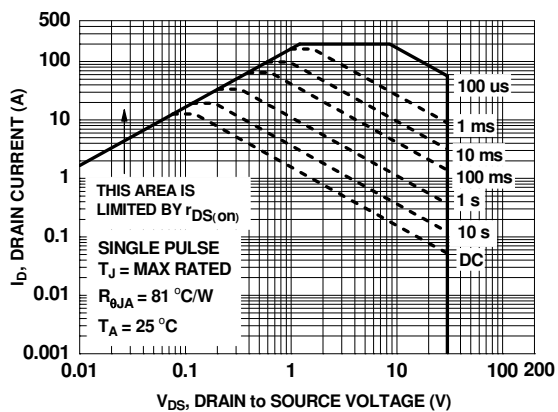

Figure 11. Forward Bias Safe Operating Area

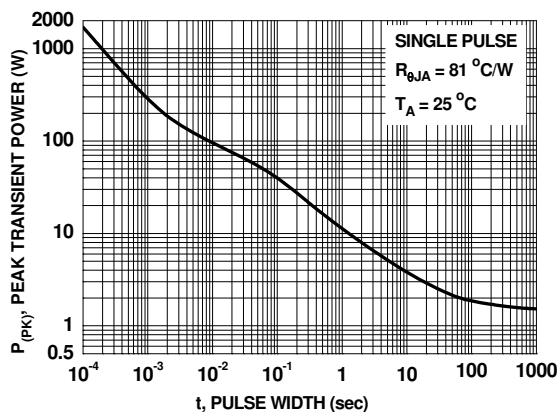
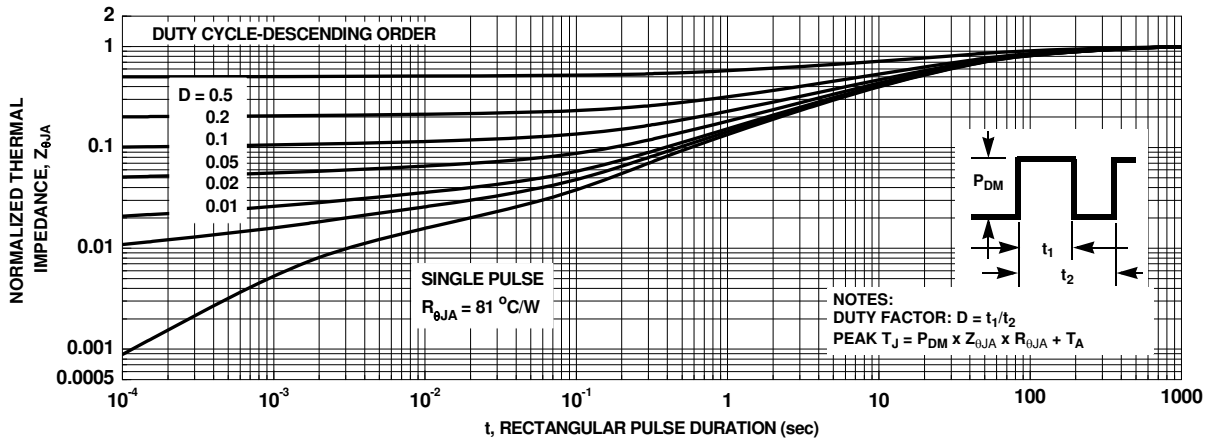
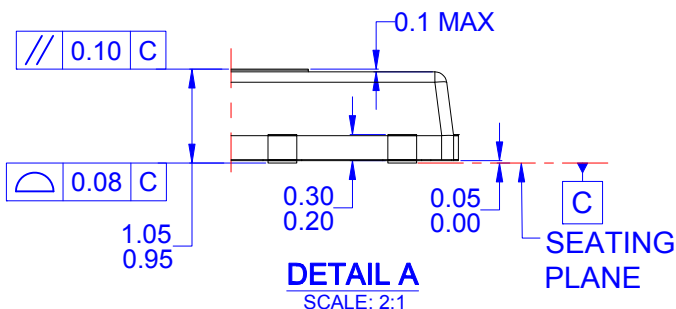
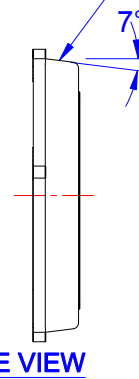
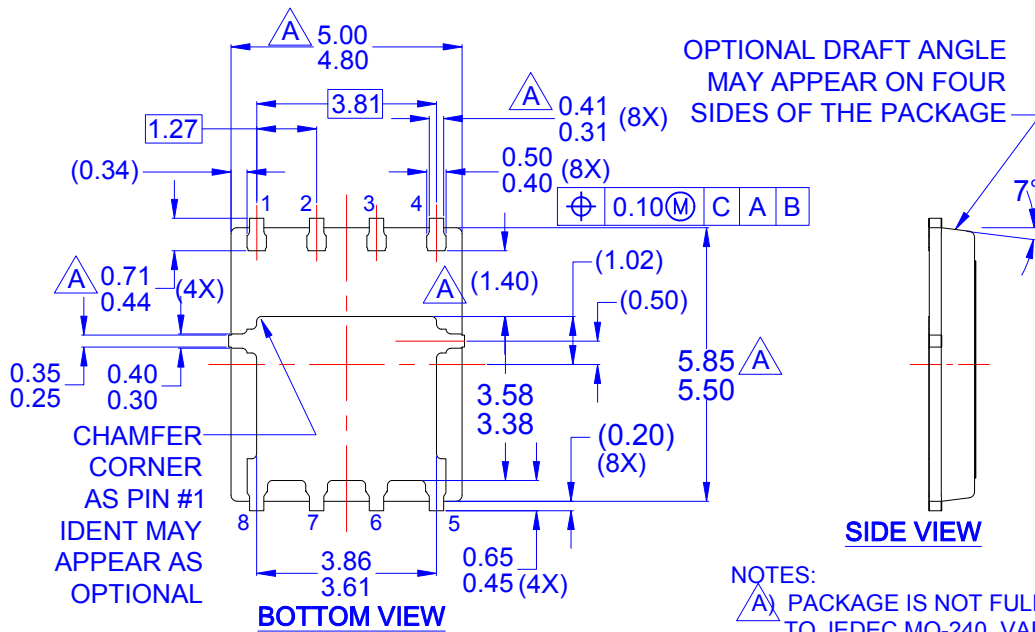
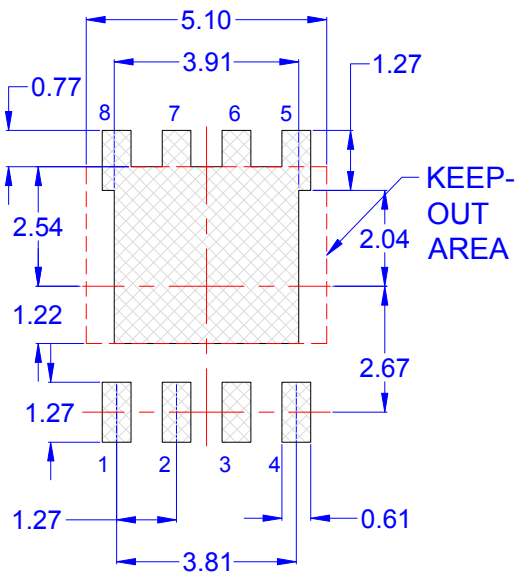
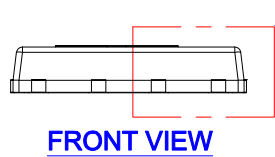
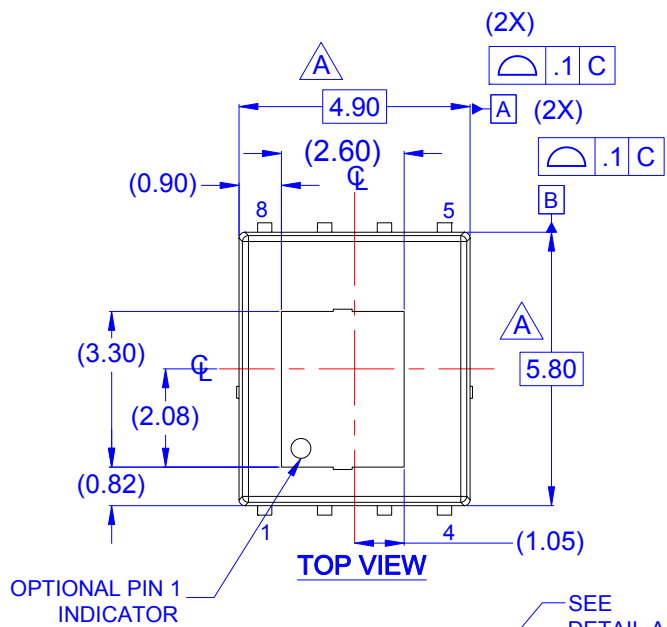

Figure 12. Single Pulse Maximum Power Dissipation

**Typical Characteristics**  $T_J = 25^\circ\text{C}$  unless otherwise noted



**Figure 13. Junction-to-Ambient Transient Thermal Response Curve**



- NOTES:
- A) PACKAGE IS NOT FULLY COMPLIANT TO JEDEC MO-240, VARIATION AA.
  - B) ALL DIMENSIONS ARE IN MILLIMETERS.
  - C) DIMENSIONS DO NOT INCLUDE BURRS OR MOLD FLASH. MOLD FLASH OR BURRS DOES NOT EXCEED 0.10MM.
  - D) DIMENSIONING AND TOLERANCING PER ASME Y14.5M-2009.
  - E) IT IS RECOMMENDED TO HAVE NO TRACES OR VIAS WITHIN THE KEEP OUT AREA.
  - F) DRAWING FILE NAME: PQFN08DREV4





ON Semiconductor and  are trademarks of Semiconductor Components Industries, LLC dba ON Semiconductor or its subsidiaries in the United States and/or other countries. ON Semiconductor owns the rights to a number of patents, trademarks, copyrights, trade secrets, and other intellectual property. A listing of ON Semiconductor's product/patent coverage may be accessed at [www.onsemi.com/site/pdf/Patent-Marking.pdf](http://www.onsemi.com/site/pdf/Patent-Marking.pdf). ON Semiconductor reserves the right to make changes without further notice to any products herein. ON Semiconductor makes no warranty, representation or guarantee regarding the suitability of its products for any particular purpose, nor does ON Semiconductor assume any liability arising out of the application or use of any product or circuit, and specifically disclaims any and all liability, including without limitation special, consequential or incidental damages. Buyer is responsible for its products and applications using ON Semiconductor products, including compliance with all laws, regulations and safety requirements or standards, regardless of any support or applications information provided by ON Semiconductor. "Typical" parameters which may be provided in ON Semiconductor data sheets and/or specifications can and do vary in different applications and actual performance may vary over time. All operating parameters, including "Typicals" must be validated for each customer application by customer's technical experts. ON Semiconductor does not convey any license under its patent rights nor the rights of others. ON Semiconductor products are not designed, intended, or authorized for use as a critical component in life support systems or any FDA Class 3 medical devices or medical devices with a same or similar classification in a foreign jurisdiction or any devices intended for implantation in the human body. Should Buyer purchase or use ON Semiconductor products for any such unintended or unauthorized application, Buyer shall indemnify and hold ON Semiconductor and its officers, employees, subsidiaries, affiliates, and distributors harmless against all claims, costs, damages, and expenses, and reasonable attorney fees arising out of, directly or indirectly, any claim of personal injury or death associated with such unintended or unauthorized use, even if such claim alleges that ON Semiconductor was negligent regarding the design or manufacture of the part. ON Semiconductor is an Equal Opportunity/Affirmative Action Employer. This literature is subject to all applicable copyright laws and is not for resale in any manner.

## PUBLICATION ORDERING INFORMATION

### LITERATURE FULFILLMENT:

Literature Distribution Center for ON Semiconductor  
19521 E. 32nd Pkwy, Aurora, Colorado 80011 USA  
**Phone:** 303-675-2175 or 800-344-3860 Toll Free USA/Canada  
**Fax:** 303-675-2176 or 800-344-3867 Toll Free USA/Canada  
**Email:** [orderlit@onsemi.com](mailto:orderlit@onsemi.com)

**N. American Technical Support:** 800-282-9855 Toll Free  
USA/Canada  
**Europe, Middle East and Africa Technical Support:**  
Phone: 421 33 790 2910  
**Japan Customer Focus Center**  
Phone: 81-3-5817-1050

**ON Semiconductor Website:** [www.onsemi.com](http://www.onsemi.com)  
**Order Literature:** <http://www.onsemi.com/orderlit>  
For additional information, please contact your local  
Sales Representative