

NTMSD3P102R2

FETKY™

P-Channel Enhancement-Mode Power MOSFET and Schottky Diode Dual SO-8 Package

Features

- High Efficiency Components in a Single SO-8 Package
- High Density Power MOSFET with Low $R_{DS(on)}$, Schottky Diode with Low V_F
- Independent Pin-Outs for MOSFET and Schottky Die Allowing for Flexibility in Application Use
- Less Component Placement for Board Space Savings
- SO-8 Surface Mount Package, Mounting Information for SO-8 Package Provided
- Pb-Free Packages are Available

Applications

- DC-DC Converters
- Low Voltage Motor Control
- Power Management in Portable and Battery-Powered Products, i.e.: Computers, Printers, PCMCIA Cards, Cellular and Cordless Telephones

MOSFET MAXIMUM RATINGS ($T_J = 25^\circ\text{C}$ unless otherwise noted).

Rating	Symbol	Value	Unit
Drain-to-Source Voltage	V_{DSS}	-20	V
Gate-to-Source Voltage - Continuous	V_{GS}	± 20	V
Thermal Resistance - Junction-to-Ambient (Note 1)	$R_{\theta JA}$	171	$^\circ\text{C}/\text{W}$
Total Power Dissipation @ $T_A = 25^\circ\text{C}$	P_D	0.73	W
Continuous Drain Current @ $T_A = 25^\circ\text{C}$	I_D	-2.34	A
Continuous Drain Current @ $T_A = 70^\circ\text{C}$	I_D	-1.87	A
Pulsed Drain Current (Note 4)	I_{DM}	-8.0	A
Thermal Resistance - Junction-to-Ambient (Note 2)	$R_{\theta JA}$	100	$^\circ\text{C}/\text{W}$
Total Power Dissipation @ $T_A = 25^\circ\text{C}$	P_D	1.25	W
Continuous Drain Current @ $T_A = 25^\circ\text{C}$	I_D	-3.05	A
Continuous Drain Current @ $T_A = 70^\circ\text{C}$	I_D	-2.44	A
Pulsed Drain Current (Note 4)	I_{DM}	-12	A
Thermal Resistance - Junction-to-Ambient (Note 3)	$R_{\theta JA}$	62.5	$^\circ\text{C}/\text{W}$
Total Power Dissipation @ $T_A = 25^\circ\text{C}$	P_D	2.0	W
Continuous Drain Current @ $T_A = 25^\circ\text{C}$	I_D	-3.86	A
Continuous Drain Current @ $T_A = 70^\circ\text{C}$	I_D	-3.10	A
Pulsed Drain Current (Note 4)	I_{DM}	-15	A
Operating and Storage Temperature Range	T_J, T_{stg}	-55 to +150	$^\circ\text{C}$
Single Pulse Drain-to-Source Avalanche Energy - Starting $T_J = 25^\circ\text{C}$ ($V_{DD} = -20$ Vdc, $V_{GS} = -4.5$ Vdc, Peak $I_L = -7.5$ Apk, $L = 5$ mH, $R_G = 25 \Omega$)	E_{AS}	140	mJ
Maximum Lead Temperature for Soldering Purposes, 1/8" from case for 10 seconds	T_L	260	$^\circ\text{C}$

Stresses exceeding Maximum Ratings may damage the device. Maximum Ratings are stress ratings only. Functional operation above the Recommended Operating Conditions is not implied. Extended exposure to stresses above the Recommended Operating Conditions may affect device reliability.

1. Minimum FR-4 or G-10 PCB, Steady State.
2. Mounted onto a 2" square FR-4 Board (1 in sq, 2 oz Cu 0.06" thick single-sided), Steady State.
3. Mounted onto a 2" square FR-4 Board (1 in sq, 2 oz Cu 0.06" thick single sided), $t \leq 10$ seconds.
4. Pulse Test: Pulse Width = 300 μs , Duty Cycle = 2%.



ON Semiconductor®

<http://onsemi.com>

MOSFET
-3.05 AMPERES
-20 VOLTS
0.085 Ω @ $V_{GS} = -10$ V

SCHOTTKY DIODE
1.0 AMPERE
20 VOLTS
470 mV @ $I_F = 1.0$ A

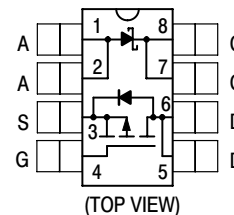

MARKING DIAGRAM & PIN ASSIGNMENT



SO-8
CASE 751
STYLE 18

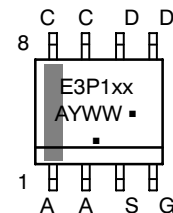

E3P1 = Device Code
xx = 02 or S
A = Assembly Location
Y = Year
WW = Work Week
▪ = Pb-Free Package

(Note: Microdot may be in either location)

ORDERING INFORMATION

Device	Package	Shipping†
NTMSD3P102R2	SO-8	2500/Tape & Reel
NTMSD3P102R2G	SO-8 (Pb-Free)	2500/Tape & Reel
NTMSD3P102R2SG	SO-8 (Pb-Free)	2500/Tape & Reel

†For information on tape and reel specifications, including part orientation and tape sizes, please refer to our Tape and Reel Packaging Specification Brochure, BRD8011/D.

NTMSD3P102R2

SCHOTTKY MAXIMUM RATINGS ($T_J = 25^\circ\text{C}$ unless otherwise noted)

Rating	Symbol	Value	Unit
Peak Repetitive Reverse Voltage DC Blocking Voltage	V_{RRM} V_R	20	V
Thermal Resistance - Junction-to-Ambient (Note 5)	$R_{\theta JA}$	204	$^\circ\text{C/W}$
Thermal Resistance - Junction-to-Ambient (Note 6)	$R_{\theta JA}$	122	$^\circ\text{C/W}$
Thermal Resistance - Junction-to-Ambient (Note 7)	$R_{\theta JA}$	83	$^\circ\text{C/W}$
Average Forward Current (Note 7) (Rated V_R , $T_A = 100^\circ\text{C}$)	I_O	1.0	A
Peak Repetitive Forward Current (Note 7) (Rated V_R , Square Wave, 20 kHz, $T_A = 105^\circ\text{C}$)	I_{FRM}	2.0	A
Non-Repetitive Peak Surge Current (Note 7) (Surge Applied at Rated Load Conditions, Half-Wave, Single Phase, 60 Hz)	I_{FSM}	20	A

Stresses exceeding Maximum Ratings may damage the device. Maximum Ratings are stress ratings only. Functional operation above the Recommended Operating Conditions is not implied. Extended exposure to stresses above the Recommended Operating Conditions may affect device reliability.

5. Minimum FR-4 or G-10 PCB, Steady State.

6. Mounted onto a 2" square FR-4 Board (1 in sq, 2 oz Cu 0.06" thick single-sided), Steady State.

7. Mounted onto a 2" square FR-4 Board (1 in sq, 2 oz Cu 0.06" thick single sided), $t \leq 10$ seconds.

SCHOTTKY ELECTRICAL CHARACTERISTICS ($T_J = 25^\circ\text{C}$ unless otherwise noted) (Note 8)

Characteristic	Symbol	Value		Unit
		$T_J = 25^\circ\text{C}$	$T_J = 125^\circ\text{C}$	
Maximum Instantaneous Forward Voltage $I_F = 1.0 \text{ Adc}$ $I_F = 2.0 \text{ Adc}$	V_F			Volts
Maximum Instantaneous Forward Voltage $I_F = 1.0 \text{ Adc}$ $I_F = 2.0 \text{ Adc}$	V_F	0.47 0.58	0.39 0.53	Volts
Maximum Instantaneous Reverse Current $V_R = 20 \text{ Vdc}$	I_R	$T_J = 25^\circ\text{C}$ 0.05	$T_J = 125^\circ\text{C}$ 10	mA
Maximum Voltage Rate of Change $V_R = 20 \text{ Vdc}$	dV/dt	10,000		V/ μs

8. Indicates Pulse Test: Pulse Width = 300 μs max, Duty Cycle = 2%.

NTMSD3P102R2

MOSFET ELECTRICAL CHARACTERISTICS (T_J = 25°C unless otherwise noted) (Note 9)

Characteristic	Symbol	Min	Typ	Max	Unit
----------------	--------	-----	-----	-----	------

OFF CHARACTERISTICS

Drain-to-Source Breakdown Voltage (V _{GS} = 0 Vdc, I _D = -250 μAdc) Temperature Coefficient (Positive)	V _{(BR)DSS}	-20 -	- -30	- -	Vdc mV/°C
Zero Gate Voltage Drain Current (V _{DS} = -20 Vdc, V _{GS} = 0 Vdc, T _J = 25°C) (V _{DS} = -20 Vdc, V _{GS} = 0 Vdc, T _J = 125°C)	I _{DSS}	- -	- -	-1.0 -25	μAdc
Gate-Body Leakage Current (V _{GS} = -20 Vdc, V _{DS} = 0 Vdc)	I _{GSS}	-	-	-100	nAdc
Gate-Body Leakage Current (V _{GS} = +20 Vdc, V _{DS} = 0 Vdc)	I _{GSS}	-	-	100	nAdc

ON CHARACTERISTICS

Gate Threshold Voltage (V _{DS} = V _{GS} , I _D = -250 μAdc) Temperature Coefficient (Negative)	V _{GS(th)}	-1.0 -	-1.7 3.6	-2.5 -	Vdc
Static Drain-to-Source On-State Resistance (V _{GS} = -10 Vdc, I _D = -3.05 Adc) (V _{GS} = -4.5 Vdc, I _D = -1.5 Adc)	R _{DS(on)}	- -	0.063 0.090	0.085 0.125	Ω
Forward Transconductance (V _{DS} = -15 Vdc, I _D = -3.05 Adc)	g _{FS}	-	5.0	-	Mhos

DYNAMIC CHARACTERISTICS

Input Capacitance	(V _{DS} = -16 Vdc, V _{GS} = 0 Vdc, f = 1.0 MHz)	C _{iss}	-	518	750	pF
Output Capacitance		C _{oss}	-	190	350	
Reverse Transfer Capacitance		C _{rss}	-	70	135	

SWITCHING CHARACTERISTICS (Notes 10 & 11)

Turn-On Delay Time	(V _{DD} = -20 Vdc, I _D = -3.05 Adc, V _{GS} = -10 Vdc, R _G = 6.0 Ω)	t _{d(on)}	-	12	22	ns
Rise Time		t _r	-	16	30	
Turn-Off Delay Time		t _{d(off)}	-	45	80	
Fall Time		t _f	-	45	80	
Turn-On Delay Time	(V _{DD} = -20 Vdc, I _D = -1.5 Adc, V _{GS} = -4.5 Vdc, R _G = 6.0 Ω)	t _{d(on)}	-	16	-	ns
Rise Time		t _r	-	42	-	
Turn-Off Delay Time		t _{d(off)}	-	32	-	
Fall Time		t _f	-	35	-	
Total Gate Charge	(V _{DS} = -20 Vdc, V _{GS} = -10 Vdc, I _D = -3.05 Adc)	Q _{tot}	-	16	25	nC
Gate-Source Charge		Q _{gs}	-	2.0	-	
Gate-Drain Charge		Q _{gd}	-	4.5	-	

BODY-DRAIN DIODE RATINGS (Note 10)

Diode Forward On-Voltage	(I _S = -3.05 Adc, V _{GS} = 0 Vdc) (I _S = -3.05 Adc, V _{GS} = 0 Vdc, T _J = 125°C)	V _{SD}	-	-0.96 -0.78	-1.25 -	Vdc
Reverse Recovery Time	(I _S = -3.05 Adc, V _{GS} = 0 Vdc, di _S /dt = 100 A/μs)	t _{rr}	-	34	-	ns
		t _a	-	18	-	
		t _b	-	16	-	
Reverse Recovery Stored Charge		Q _{RR}	-	0.03	-	μC

9. Handling precautions to protect against electrostatic discharge are mandatory.

10. Indicates Pulse Test: Pulse Width = 300 μs max, Duty Cycle = 2%.

11. Switching characteristics are independent of operating junction temperature.

TYPICAL MOSFET ELECTRICAL CHARACTERISTICS

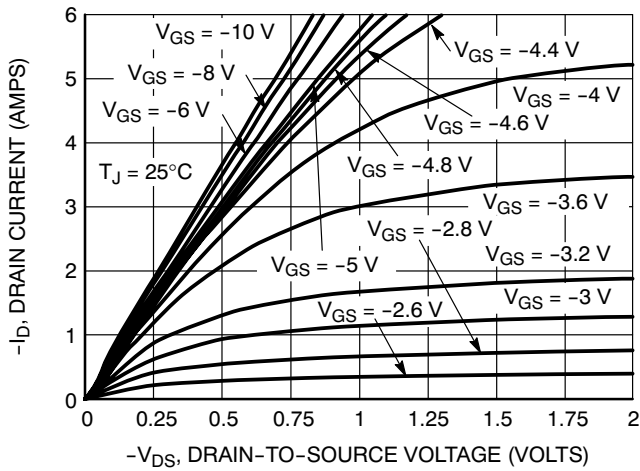

Figure 1. On-Region Characteristics

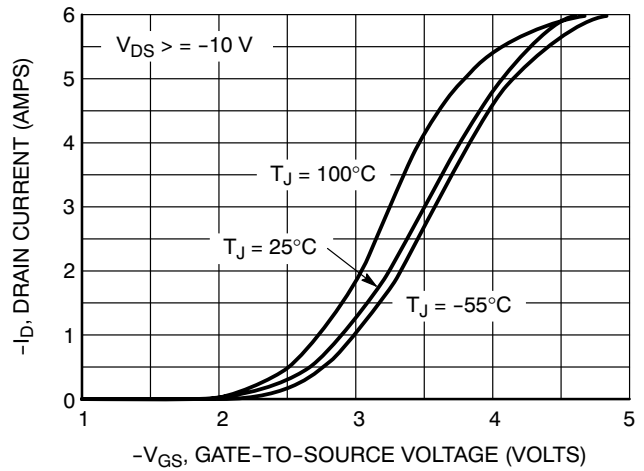

Figure 2. Transfer Characteristics

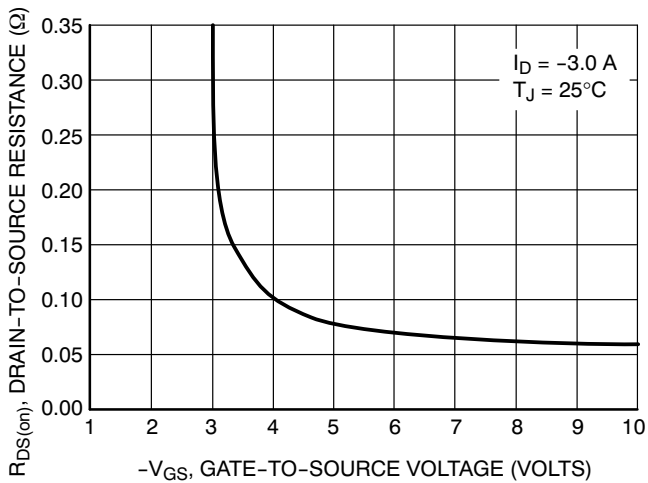

Figure 3. On-Resistance vs. Gate-to-Source Voltage

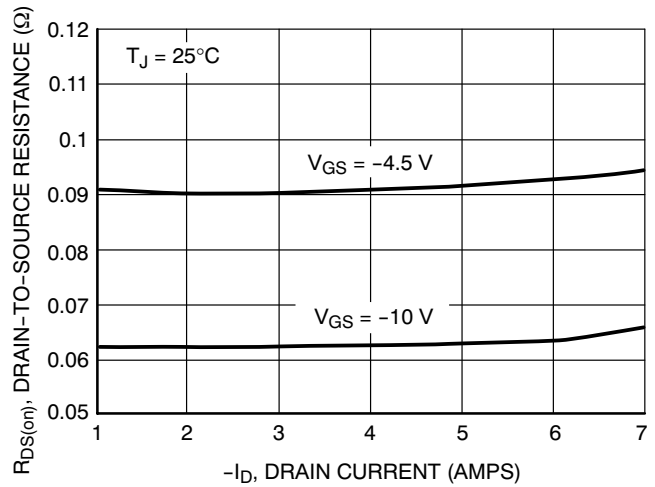

Figure 4. On-Resistance vs. Drain Current and Gate Voltage

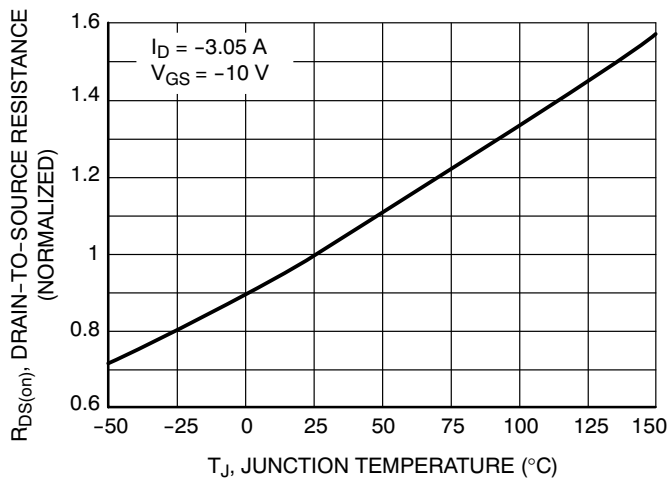

Figure 5. On Resistance Variation with Temperature

NTMSD3P102R2

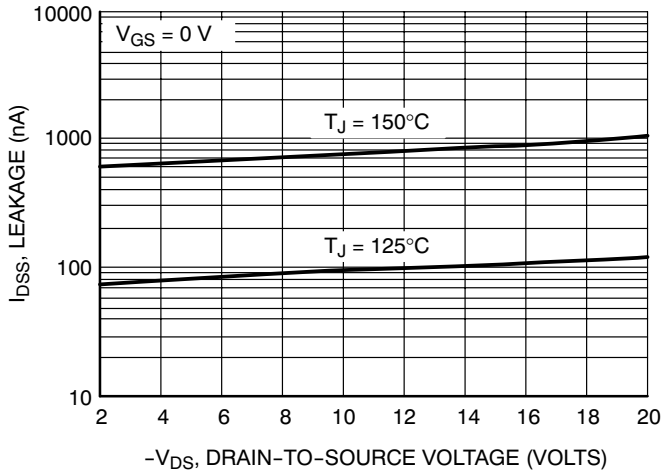

Figure 6. Drain-to-Source Leakage Current vs. Voltage

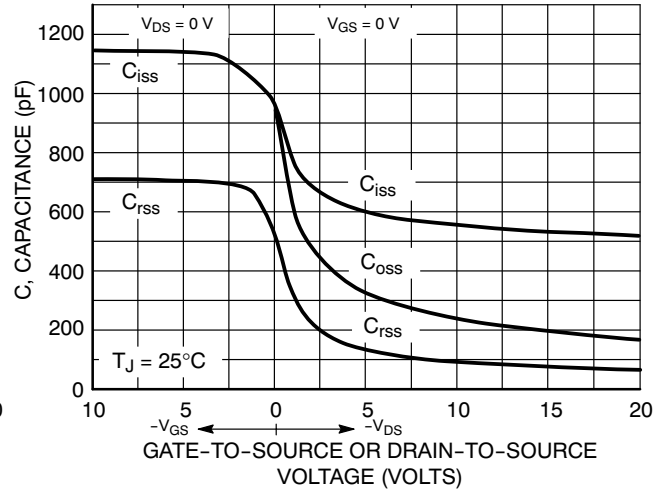

Figure 7. Capacitance Variation

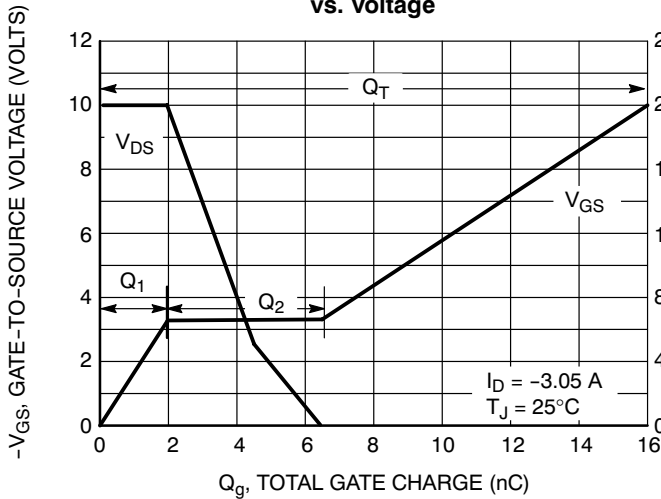

Figure 8. Gate-to-Source and Drain-to-Source Voltage vs. Total Charge

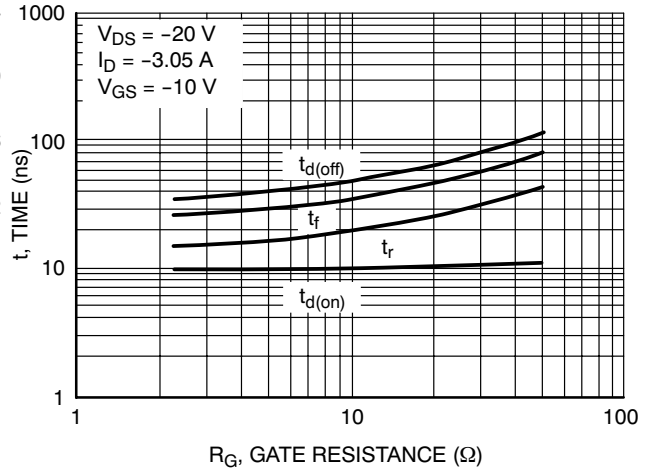

Figure 9. Resistive Switching Time Variation vs. Gate Resistance

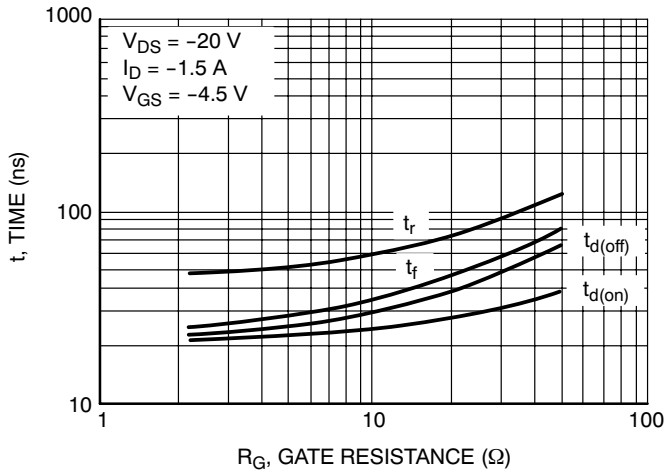

Figure 10. Resistive Switching Time Variation vs. Gate Resistance

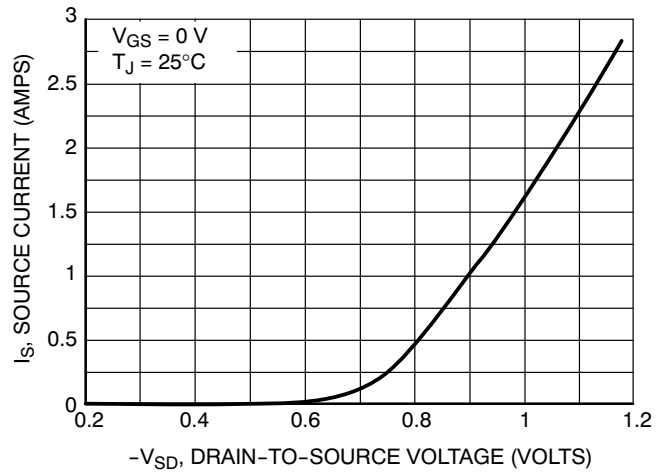

Figure 11. Diode Forward Voltage vs. Current

NTMSD3P102R2

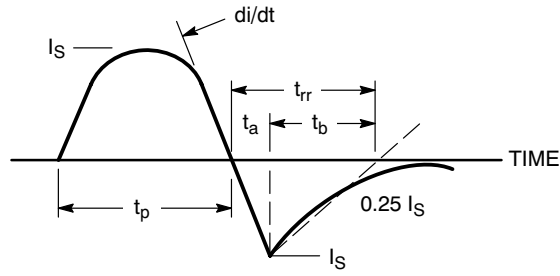

Figure 12. Diode Reverse Recovery Waveform

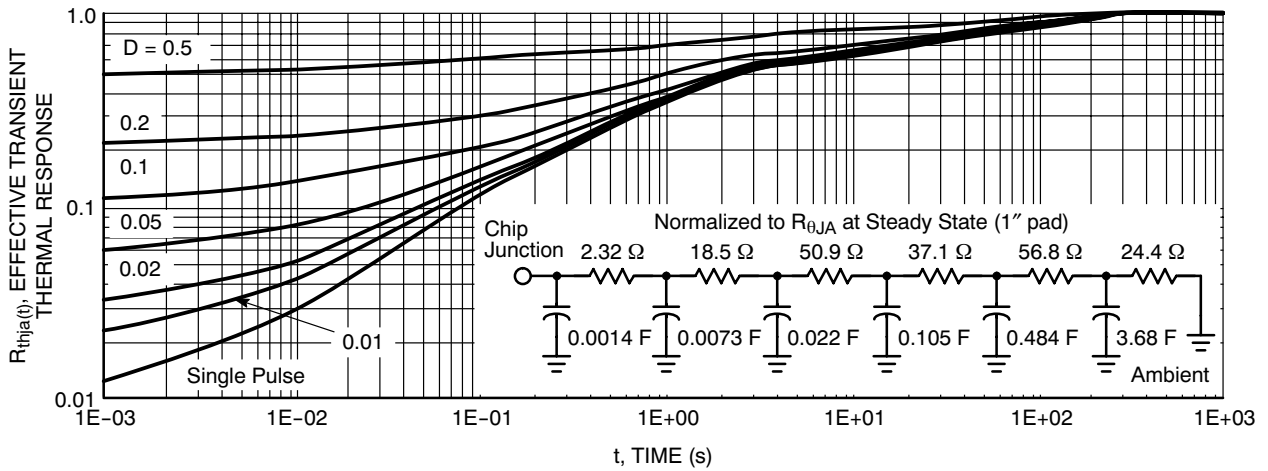

Figure 13. FET Thermal Response

TYPICAL SCHOTTKY ELECTRICAL CHARACTERISTICS

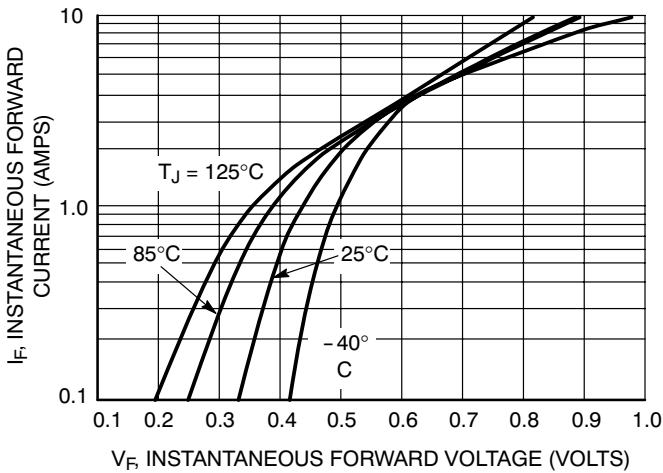

Figure 14. Typical Forward Voltage

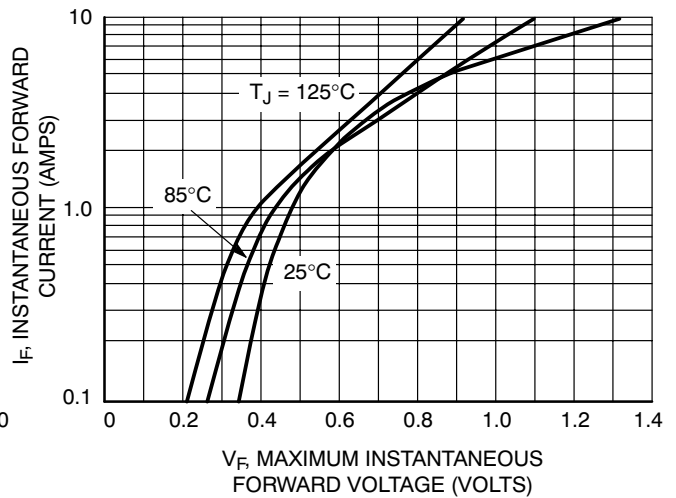

Figure 15. Maximum Forward Voltage

NTMSD3P102R2

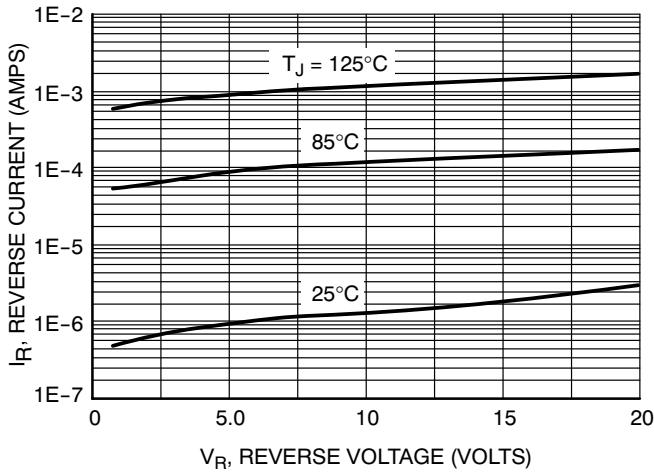

Figure 16. Typical Reverse Current

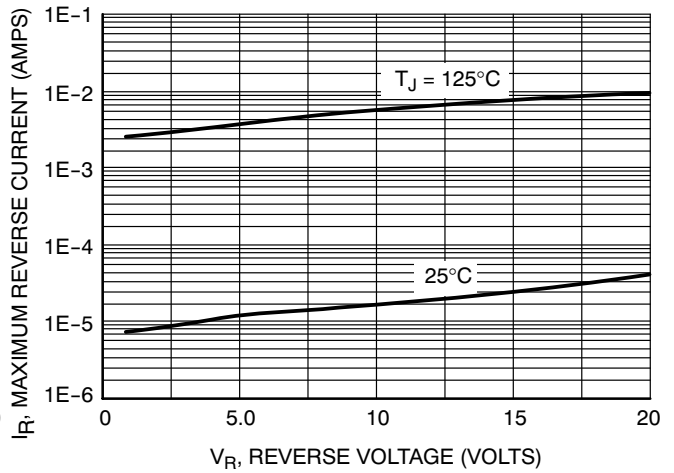

Figure 17. Maximum Reverse Current

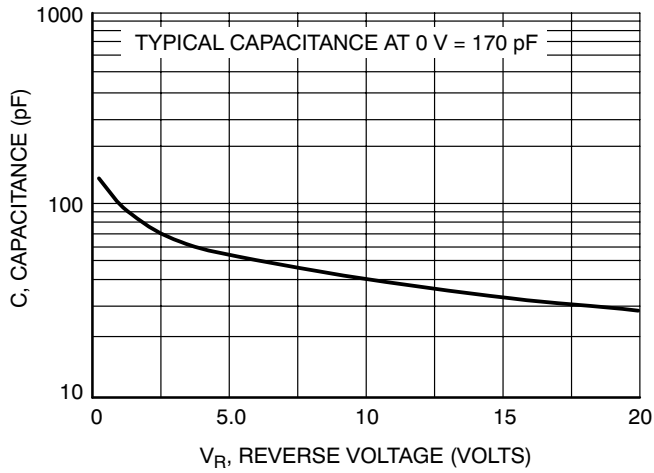

Figure 18. Typical Capacitance

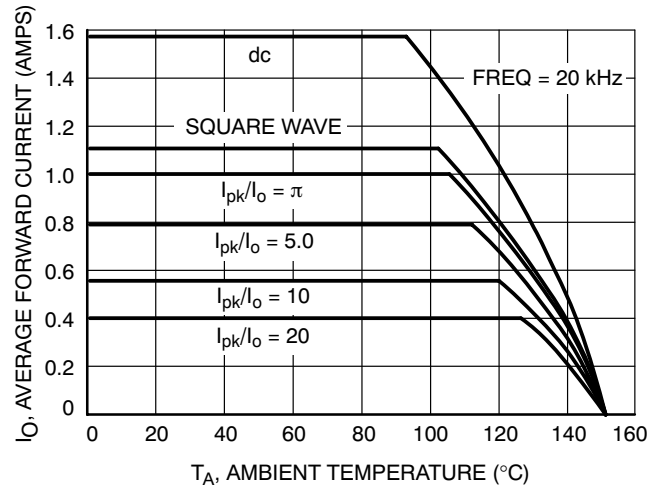

Figure 19. Current Derating

NTMSD3P102R2

TYPICAL SCHOTTKY ELECTRICAL CHARACTERISTICS

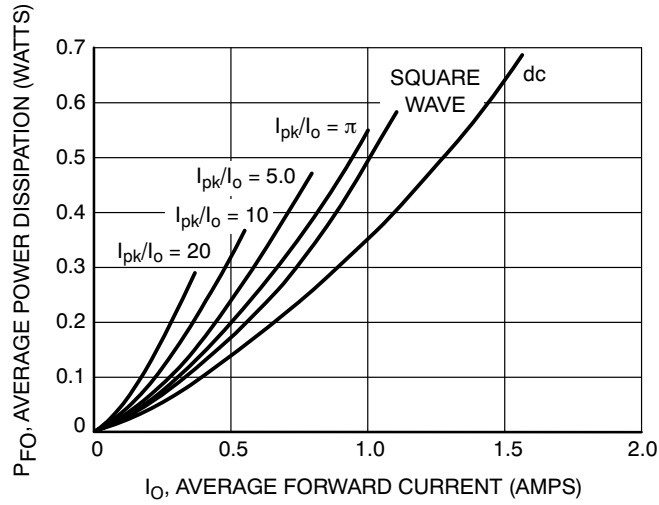

Figure 20. Forward Power Dissipation

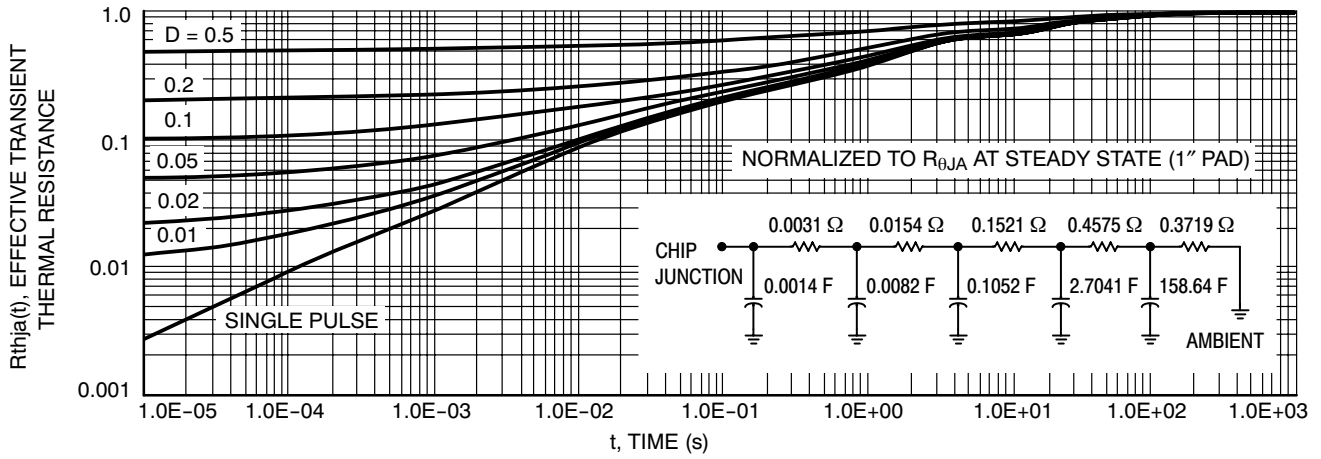
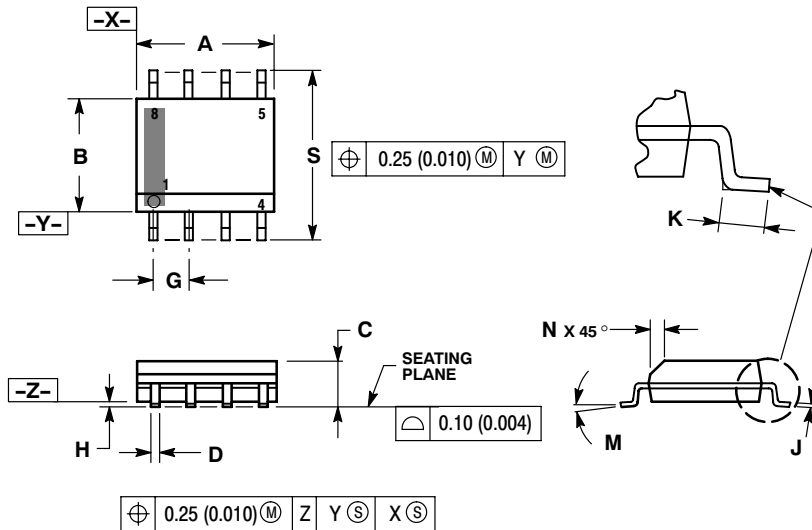

Figure 21. Schottky Thermal Response

NTMSD3P102R2

PACKAGE DIMENSIONS

SO-8 NB
CASE 751-07
ISSUE AH



NOTES:

1. DIMENSIONING AND TOLERANCING PER ANSI Y14.5M, 1982.
2. CONTROLLING DIMENSION: MILLIMETER.
3. DIMENSION A AND B DO NOT INCLUDE MOLD PROTRUSION.
4. MAXIMUM MOLD PROTRUSION 0.15 (0.006) PER SIDE.
5. DIMENSION D DOES NOT INCLUDE DAMBAR PROTRUSION. ALLOWABLE DAMBAR PROTRUSION SHALL BE 0.127 (0.005) TOTAL IN EXCESS OF THE D DIMENSION AT MAXIMUM MATERIAL CONDITION.
6. 751-01 THRU 751-06 ARE OBSOLETE. NEW STANDARD IS 751-07.

DIM	MILLIMETERS		INCHES	
	MIN	MAX	MIN	MAX
A	4.80	5.00	0.189	0.197
B	3.80	4.00	0.150	0.157
C	1.35	1.75	0.053	0.069
D	0.33	0.51	0.013	0.020
G	1.27 BSC		0.050 BSC	
H	0.10	0.25	0.004	0.010
J	0.19	0.25	0.007	0.010
K	0.40	1.27	0.016	0.050
M	0°	8°	0°	8°
N	0.25	0.50	0.010	0.020
S	5.80	6.20	0.228	0.244

SOLDERING FOOTPRINT*

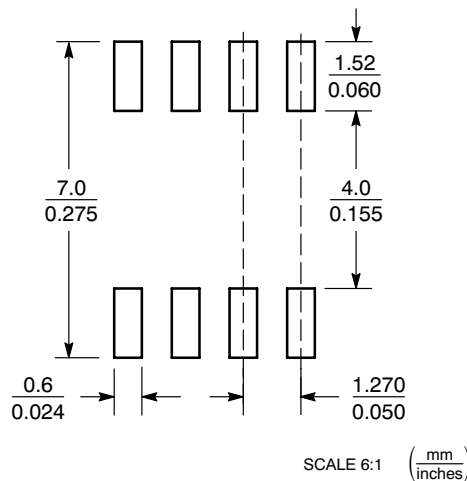

STYLE 18:

- PIN 1. ANODE
- 2. ANODE
- 3. SOURCE
- 4. GATE
- 5. DRAIN
- 6. DRAIN
- 7. CATHODE
- 8. CATHODE

*For additional information on our Pb-Free strategy and soldering details, please download the ON Semiconductor Soldering and Mounting Techniques Reference Manual, SOLDERRM/D.

FETKY is a registered trademark of International Rectifier Corporation.

ON Semiconductor and are registered trademarks of Semiconductor Components Industries, LLC (SCILLC). SCILLC reserves the right to make changes without further notice to any products herein. SCILLC makes no warranty, representation or guarantee regarding the suitability of its products for any particular purpose, nor does SCILLC assume any liability arising out of the application or use of any product or circuit, and specifically disclaims any and all liability, including without limitation special, consequential or incidental damages. "Typical" parameters which may be provided in SCILLC data sheets and/or specifications can and do vary in different applications and actual performance may vary over time. All operating parameters, including "Typicals" must be validated for each customer application by customer's technical experts. SCILLC does not convey any license under its patent rights nor the rights of others. SCILLC products are not designed, intended, or authorized for use as components in systems intended for surgical implant into the body, or other applications intended to support or sustain life, or for any other application in which the failure of the SCILLC product could create a situation where personal injury or death may occur. Should Buyer purchase or use SCILLC products for any such unintended or unauthorized application, Buyer shall indemnify and hold SCILLC and its officers, employees, subsidiaries, affiliates, and distributors harmless against all claims, costs, damages, and expenses, and reasonable attorney fees arising out of, directly or indirectly, any claim of personal injury or death associated with such unintended or unauthorized use, even if such claim alleges that SCILLC was negligent regarding the design or manufacture of the part. SCILLC is an Equal Opportunity/Affirmative Action Employer. This literature is subject to all applicable copyright laws and is not for resale in any manner.

PUBLICATION ORDERING INFORMATION

LITERATURE FULFILLMENT:
Literature Distribution Center for ON Semiconductor
P.O. Box 5163, Denver, Colorado 80217 USA
Phone: 303-675-2175 or 800-344-3860 Toll Free USA/Canada
Fax: 303-675-2176 or 800-344-3867 Toll Free USA/Canada
Email: orderlit@onsemi.com

N. American Technical Support: 800-282-9855 Toll Free USA/Canada
Europe, Middle East and Africa Technical Support:
Phone: 421 33 790 2910
Japan Customer Focus Center
Phone: 81-3-5773-3850

ON Semiconductor Website: www.onsemi.com
Order Literature: <http://www.onsemi.com/orderlit>

For additional information, please contact your local Sales Representative