

# NTR1P02, NVR1P02

## MOSFET – Power, P-Channel, SOT-23 -20 V, -1 A

### Features

- Ultra Low On-Resistance Provides Higher Efficiency and Extends Battery Life  
 $R_{DS(on)} = 0.180 \Omega, V_{GS} = -10 \text{ V}$   
 $R_{DS(on)} = 0.280 \Omega, V_{GS} = -4.5 \text{ V}$
- Power Management in Portable and Battery-Powered Products
- Miniature SOT-23 Surface Mount Package Saves Board Space
- Mounting Information for SOT-23 Package Provided
- NVR Prefix for Automotive and Other Applications Requiring Unique Site and Control Change Requirements; AEC-Q101 Qualified and PPAP Capable
- These Devices are Pb-Free and are RoHS Compliant

### Applications

- DC-DC Converters
- Computers
- Printers
- PCMCIA Cards
- Cellular and Cordless Telephones

### MAXIMUM RATINGS ( $T_J = 25^\circ\text{C}$ unless otherwise noted)

Rating	Symbol	Value	Unit
Drain-to-Source Voltage	$V_{DSS}$	-20	V
Gate-to-Source Voltage – Continuous	$V_{GS}$	$\pm 20$	V
Drain Current	$I_D$	-1.0	A
– Continuous @ $T_A = 25^\circ\text{C}$	$I_{DM}$	-2.67	
– Pulsed Drain Current ( $t_p \leq 1 \mu\text{s}$ )			
Total Power Dissipation @ $T_A = 25^\circ\text{C}$	$P_D$	400	mW
Operating and Storage Temperature Range	$T_J, T_{stg}$	-55 to 150	$^\circ\text{C}$
Thermal Resistance; Junction-to-Ambient	$R_{\theta JA}$	300	$^\circ\text{C/W}$
Maximum Lead Temperature for Soldering Purposes, (1/8" from case for 10 s)	$T_L$	260	$^\circ\text{C}$

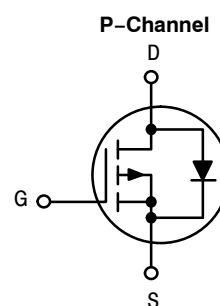
Stresses exceeding those listed in the Maximum Ratings table may damage the device. If any of these limits are exceeded, device functionality should not be assumed, damage may occur and reliability may be affected.



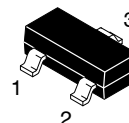
ON Semiconductor®

[www.onsemi.com](http://www.onsemi.com)

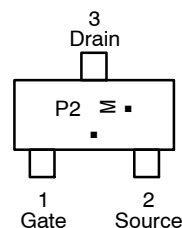
$V_{(BR)DSS}$	$R_{DS(on)}$ TYP	$I_D$ MAX
-20 V	148 m $\Omega$ @ -10 V	-1.0 A



### MARKING DIAGRAM/ PIN ASSIGNMENT



SOT-23  
CASE 318  
STYLE 21



P2 = Specific Device Code  
M = Date Code  
▪ = Pb-Free Package  
(Note: Microdot may be in either location)

### ORDERING INFORMATION

Device	Package	Shipping†
NTR1P02T1G	SOT-23 (Pb-Free)	3000 / Tape & Reel
NTR1P02T3G	SOT-23 (Pb-Free)	10000 / Tape & Reel
NVR1P02T1G	SOT-23 (Pb-Free)	3000 / Tape & Reel

†For information on tape and reel specifications, including part orientation and tape sizes, please refer to our Tape and Reel Packaging Specification Brochure, BRD8011/D.

# NTR1P02, NVR1P02

## ELECTRICAL CHARACTERISTICS ( $T_A = 25^\circ\text{C}$ unless otherwise noted)

Characteristic	Symbol	Min	Typ	Max	Unit
----------------	--------	-----	-----	-----	------

### OFF CHARACTERISTICS

Drain-to-Source Breakdown Voltage ( $V_{GS} = 0\text{ V}$ , $I_D = -10\ \mu\text{A}$ ) (Positive Temperature Coefficient)	$V_{(BR)DSS}$	-20	32		V mV/ $^\circ\text{C}$
Zero Gate Voltage Drain Current ( $V_{DS} = -20\text{ V}$ , $V_{GS} = 0\text{ V}$ , $T_J = 25^\circ\text{C}$ ) ( $V_{DS} = -20\text{ V}$ , $V_{GS} = 0\text{ V}$ , $T_J = 150^\circ\text{C}$ )	$I_{DSS}$			-1.0 -10	$\mu\text{A}$
Gate-Body Leakage Current ( $V_{GS} = \pm 20\text{ V}$ , $V_{DS} = 0\text{ V}$ )	$I_{GSS}$			$\pm 100$	nA

### ON CHARACTERISTICS (Note 1)

Gate Threshold Voltage ( $V_{DS} = V_{GS}$ , $I_D = -250\ \mu\text{A}$ ) (Negative Temperature Coefficient)	$V_{GS(th)}$	-1.1	-1.9 -4.0	-2.3	V mV/ $^\circ\text{C}$
Static Drain-to-Source On-State Resistance ( $V_{GS} = -10\text{ V}$ , $I_D = -1.5\text{ A}$ ) ( $V_{GS} = -4.5\text{ V}$ , $I_D = -0.75\text{ A}$ )	$R_{DS(on)}$		0.148 0.235	0.180 0.280	$\Omega$

### DYNAMIC CHARACTERISTICS

Input Capacitance ( $V_{DS} = -5\text{ V}$ , $V_{GS} = 0\text{ V}$ , $f = 1.0\text{ MHz}$ )	$C_{iss}$		165		pF
Output Capacitance ( $V_{DS} = -5\text{ V}$ , $V_{GS} = 0\text{ V}$ , $f = 1.0\text{ MHz}$ )	$C_{oss}$		110		
Reverse Transfer Capacitance ( $V_{DS} = -5\text{ V}$ , $V_{GS} = 0\text{ V}$ , $f = 1.0\text{ MHz}$ )	$C_{rss}$		35		

### SWITCHING CHARACTERISTICS (Note 2)

Turn-On Delay Time ( $V_{DD} = -15\text{ V}$ , $I_D = -1\text{ A}$ , $V_{GS} = -5\text{ V}$ , $R_G = 2.5\ \Omega$ )	$t_{d(on)}$		7.0		ns
Rise Time ( $V_{DD} = -15\text{ V}$ , $I_D = -1\text{ A}$ , $V_{GS} = -5\text{ V}$ , $R_G = 2.5\ \Omega$ )	$t_r$		9.0		
Turn-Off Delay Time ( $V_{DD} = -15\text{ V}$ , $I_D = -1\text{ A}$ , $V_{GS} = -5\text{ V}$ , $R_G = 2.5\ \Omega$ )	$t_{d(off)}$		9.0		
Fall Time ( $V_{DD} = -15\text{ V}$ , $I_D = -1\text{ A}$ , $V_{GS} = -5\text{ V}$ , $R_G = 2.5\ \Omega$ )	$t_f$		3.0		
Total Gate Charge ( $V_{DS} = -15\text{ V}$ , $V_{GS} = -5\text{ V}$ , $I_D = -0.8\text{ A}$ )	$Q_{tot}$		2.5		nC
Gate-Source Charge ( $V_{DS} = -15\text{ V}$ , $V_{GS} = -5\text{ V}$ , $I_D = -0.8\text{ A}$ )	$Q_{gs}$		0.75		
Gate-Drain Charge ( $V_{DS} = -15\text{ V}$ , $V_{GS} = -5\text{ V}$ , $I_D = -0.8\text{ A}$ )	$Q_{gd}$		1.0		

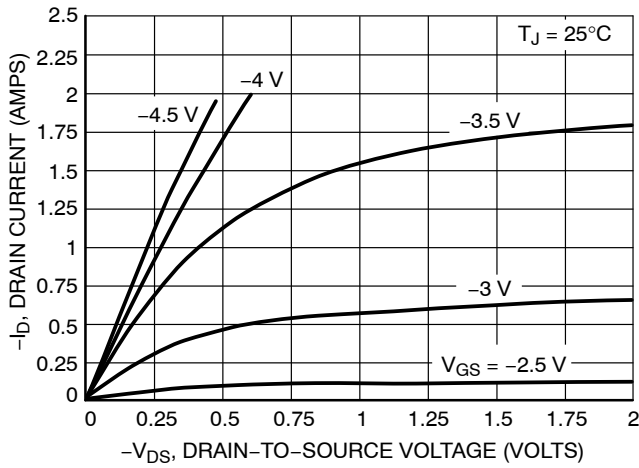
### BODY-DRAIN DIODE RATINGS (Note 1)

Diode Forward On-Voltage (Note 2) ( $I_S = -0.6\text{ A}$ , $V_{GS} = 0\text{ V}$ ) ( $I_S = -0.6\text{ A}$ , $V_{GS} = 0\text{ V}$ , $T_J = 150^\circ\text{C}$ )	$V_{SD}$		-0.8 -0.6	-1.0	V
Reverse Recovery Time ( $I_S = -1\text{ A}$ , $di_S/dt = 100\text{ A}/\mu\text{s}$ , $V_{GS} = 0\text{ V}$ )	$t_{rr}$		13.5		ns
	$t_a$		10.5		
	$t_b$		3.0		
Reverse Recovery Stored Charge ( $I_S = -1\text{ A}$ , $di_S/dt = 100\text{ A}/\mu\text{s}$ , $V_{GS} = 0\text{ V}$ )	$Q_{RR}$		0.008		$\mu\text{C}$

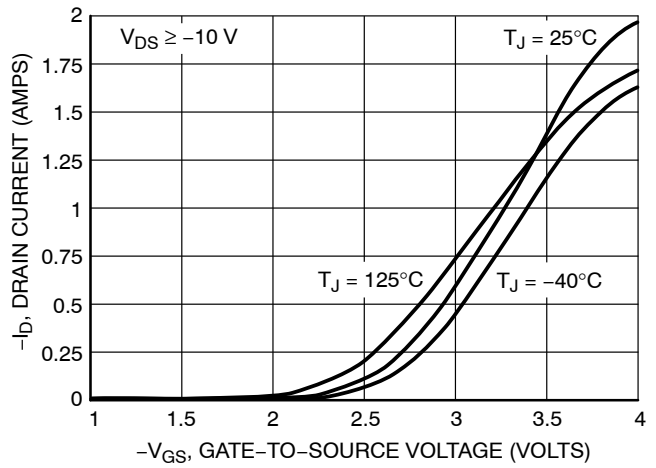
Product parametric performance is indicated in the Electrical Characteristics for the listed test conditions, unless otherwise noted. Product performance may not be indicated by the Electrical Characteristics if operated under different conditions.

1. Pulse Test: Pulse Width  $\leq 300\ \mu\text{s}$ , Duty Cycle  $\leq 2\%$ .
2. Switching characteristics are independent of operating junction temperature.

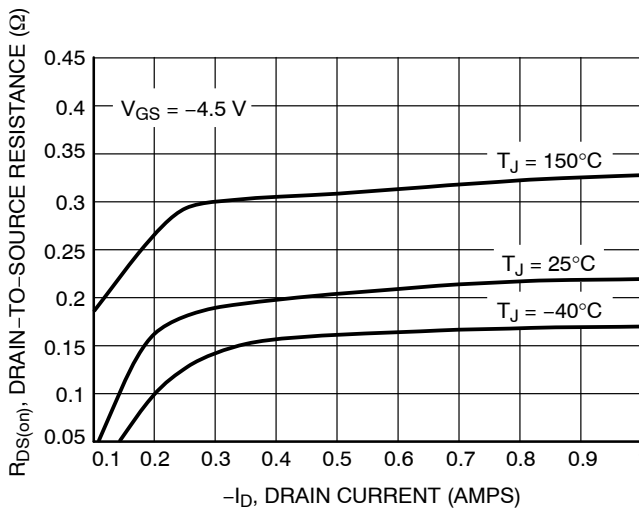
# NTR1P02, NVR1P02



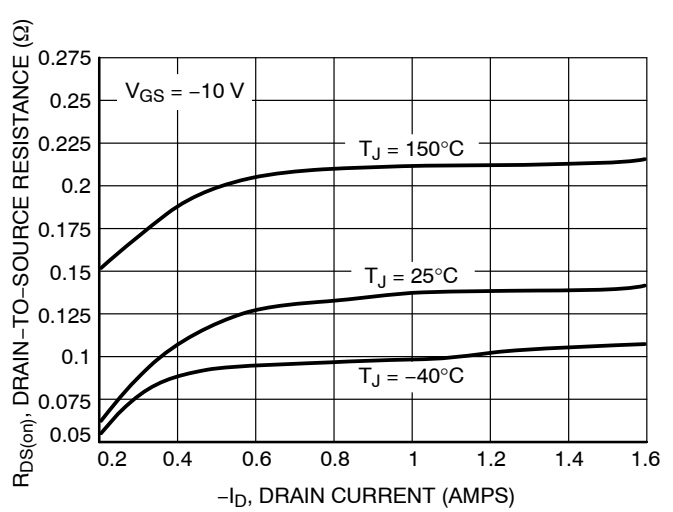
**Figure 1. On-Region Characteristics**



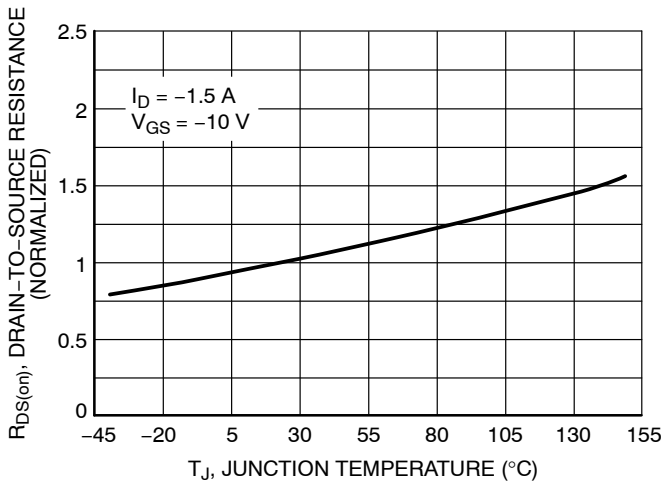
**Figure 2. Transfer Characteristics**



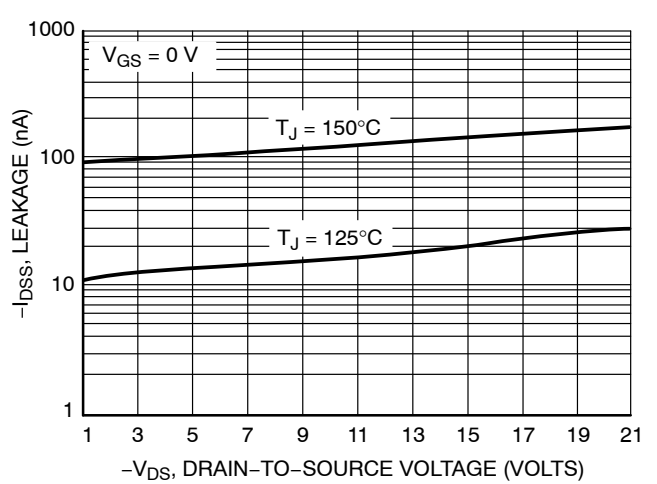
**Figure 3. On-Resistance versus Drain Current and Temperature**



**Figure 4. On-Resistance versus Drain Current and Temperature**

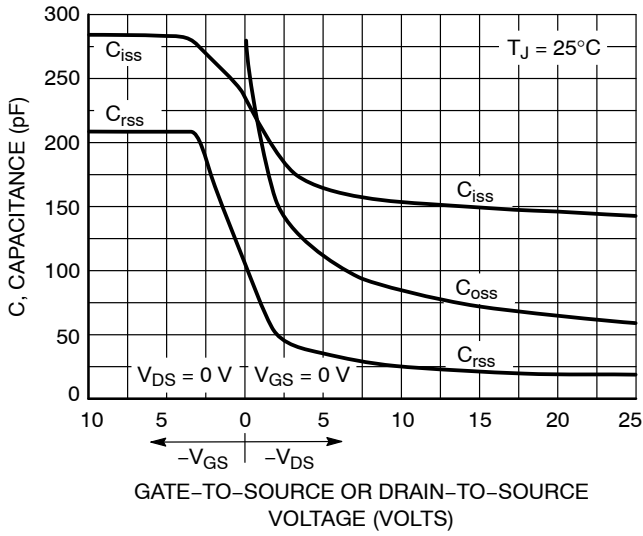


**Figure 5. On-Resistance Variation with Temperature**

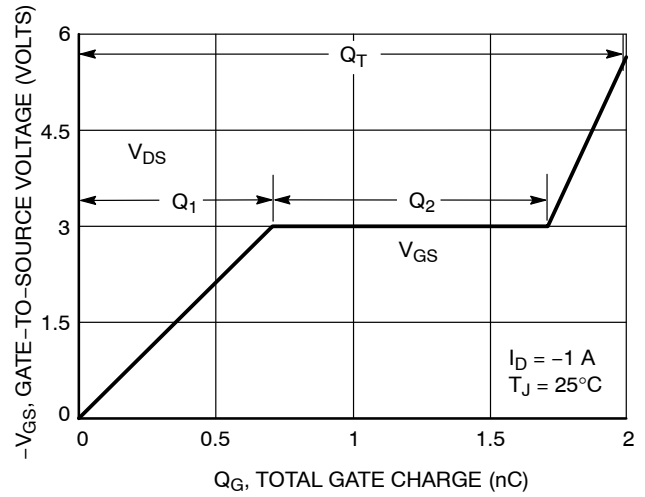


**Figure 6. Drain-to-Source Leakage Current versus Voltage**

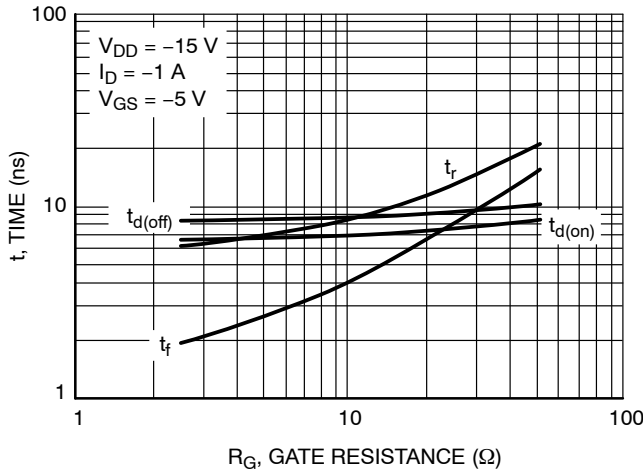
# NTR1P02, NVR1P02



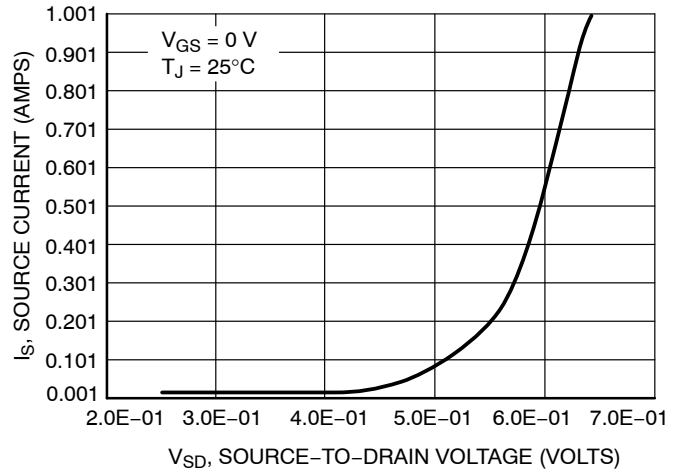
**Figure 7. Capacitance Variation**



**Figure 8. Gate-to-Source and Drain-to-Source Voltage versus Total Charge**



**Figure 9. Resistive Switching Time Variation versus Gate Resistance**



**Figure 10. Diode Forward Voltage versus Current**

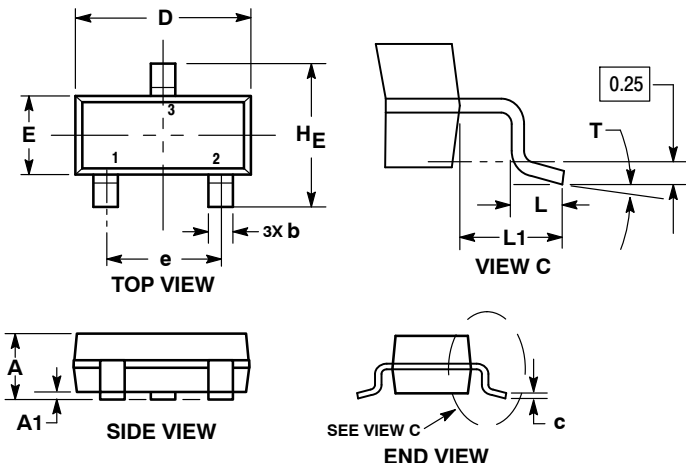
# NTR1P02, NVR1P02

## PACKAGE DIMENSIONS

SOT-23 (TO-236)

CASE 318-08

ISSUE AR



**NOTES:**

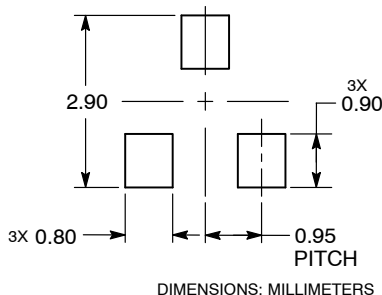
1. DIMENSIONING AND TOLERANCING PER ASME Y14.5M, 1994.
2. CONTROLLING DIMENSION: MILLIMETERS.
3. MAXIMUM LEAD THICKNESS INCLUDES LEAD FINISH. MINIMUM LEAD THICKNESS IS THE MINIMUM THICKNESS OF THE BASE MATERIAL.
4. DIMENSIONS D AND E DO NOT INCLUDE MOLD FLASH, PROTRUSIONS, OR GATE BURRS.

DIM	MILLIMETERS			INCHES		
	MIN	NOM	MAX	MIN	NOM	MAX
A	0.89	1.00	1.11	0.035	0.039	0.044
A1	0.01	0.06	0.10	0.000	0.002	0.004
b	0.37	0.44	0.50	0.015	0.017	0.020
c	0.08	0.14	0.20	0.003	0.006	0.008
D	2.80	2.90	3.04	0.110	0.114	0.120
E	1.20	1.30	1.40	0.047	0.051	0.055
e	1.78	1.90	2.04	0.070	0.075	0.080
L	0.30	0.43	0.55	0.012	0.017	0.022
L1	0.35	0.54	0.69	0.014	0.021	0.027
HE	2.10	2.40	2.64	0.083	0.094	0.104
T	0°	---	10°	0°	---	10°

**STYLE 21:**

1. GATE
2. SOURCE
3. DRAIN

### RECOMMENDED SOLDERING FOOTPRINT\*



\*For additional information on our Pb-Free strategy and soldering details, please download the ON Semiconductor Soldering and Mounting Techniques Reference Manual, SOLDERRM/D.

ON Semiconductor and are trademarks of Semiconductor Components Industries, LLC dba ON Semiconductor or its subsidiaries in the United States and/or other countries. ON Semiconductor owns the rights to a number of patents, trademarks, copyrights, trade secrets, and other intellectual property. A listing of ON Semiconductor's product/patent coverage may be accessed at [www.onsemi.com/site/pdf/Patent-Marking.pdf](http://www.onsemi.com/site/pdf/Patent-Marking.pdf). ON Semiconductor reserves the right to make changes without further notice to any products herein. ON Semiconductor makes no warranty, representation or guarantee regarding the suitability of its products for any particular purpose, nor does ON Semiconductor assume any liability arising out of the application or use of any product or circuit, and specifically disclaims any and all liability, including without limitation special, consequential or incidental damages. Buyer is responsible for its products and applications using ON Semiconductor products, including compliance with all laws, regulations and safety requirements or standards, regardless of any support or applications information provided by ON Semiconductor. "Typical" parameters which may be provided in ON Semiconductor data sheets and/or specifications can and do vary in different applications and actual performance may vary over time. All operating parameters, including "Typicals" must be validated for each customer application by customer's technical experts. ON Semiconductor does not convey any license under its patent rights nor the rights of others. ON Semiconductor products are not designed, intended, or authorized for use as a critical component in life support systems or any FDA Class 3 medical devices or medical devices with a same or similar classification in a foreign jurisdiction or any devices intended for implantation in the human body. Should Buyer purchase or use ON Semiconductor products for any such unintended or unauthorized application, Buyer shall indemnify and hold ON Semiconductor and its officers, employees, subsidiaries, affiliates, and distributors harmless against all claims, costs, damages, and expenses, and reasonable attorney fees arising out of, directly or indirectly, any claim of personal injury or death associated with such unintended or unauthorized use, even if such claim alleges that ON Semiconductor was negligent regarding the design or manufacture of the part. ON Semiconductor is an Equal Opportunity/Affirmative Action Employer. This literature is subject to all applicable copyright laws and is not for resale in any manner.

### PUBLICATION ORDERING INFORMATION

**LITERATURE FULFILLMENT:**

Literature Distribution Center for ON Semiconductor  
 19521 E. 32nd Pkwy, Aurora, Colorado 80011 USA  
**Phone:** 303-675-2175 or 800-344-3860 Toll Free USA/Canada  
**Fax:** 303-675-2176 or 800-344-3867 Toll Free USA/Canada  
**Email:** [orderlit@onsemi.com](mailto:orderlit@onsemi.com)

**N. American Technical Support:** 800-282-9855 Toll Free  
 USA/Canada  
**Europe, Middle East and Africa Technical Support:**  
 Phone: 421 33 790 2910  
**Japan Customer Focus Center**  
 Phone: 81-3-5817-1050

**ON Semiconductor Website:** [www.onsemi.com](http://www.onsemi.com)  
**Order Literature:** <http://www.onsemi.com/orderlit>

For additional information, please contact your local Sales Representative