

N-channel 600 V, 35 mΩ typ., 63 A MDmesh™ M6 Power MOSFET in a TO-247 long leads package

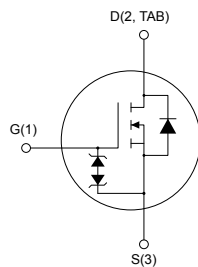

AM01475V1

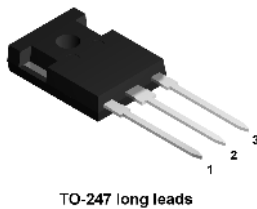

Maturity status link

[STWA68N60M6](#)

Device summary

Order code	STWA68N60M6
Marking	68N60M6
Package	TO-247 long leads
Packing	Tube

Features

Order code	V _{DS}	R _{DS(on)} max.	I _D
STWA68N60M6	600 V	41 mΩ	63 A

- Reduced switching losses
- Lower R_{DS(on)} per area vs previous generation
- Low gate input resistance
- 100% avalanche tested
- Zener-protected

Applications

- Switching applications
- LLC converters
- Boost PFC converters

Description

The new MDmesh™ M6 technology incorporates the most recent advancements to the well-known and consolidated MDmesh family of SJ MOSFETs. STMicroelectronics builds on the previous generation of MDmesh devices through its new M6 technology, which combines excellent R_{DS(on)} per area improvement with one of the most effective switching behaviors available, as well as a user-friendly experience for maximum end-application efficiency.

1 Electrical ratings

Table 1. Absolute maximum ratings

Symbol	Parameter	Value	Unit
V_{GS}	Gate-source voltage	± 25	V
I_D	Drain current (continuous) at $T_C = 25\text{ }^\circ\text{C}$	63	A
	Drain current (continuous) at $T_C = 100\text{ }^\circ\text{C}$	40	A
$I_{DM}^{(1)}$	Drain current (pulsed)	252	A
P_{TOT}	Total power dissipation at $T_C = 25\text{ }^\circ\text{C}$	390	W
$dv/dt^{(2)}$	Peak diode recovery voltage slope	15	V/ns
$dv/dt^{(3)}$	MOSFET dv/dt ruggedness	100	
T_{stg}	Storage temperature range	-55 to 150	$^\circ\text{C}$
T_j	Operating junction temperature range		

1. Pulse width is limited by safe operating area.
2. $I_{SD} \leq 63\text{ A}$, $di/dt \leq 400\text{ A}/\mu\text{s}$, $V_{DS(peak)} < V_{(BR)DSS}$, $V_{DD} = 400\text{ V}$
3. $V_{DS} \leq 480\text{ V}$

Table 2. Thermal data

Symbol	Parameter	Value	Unit
$R_{thj-case}$	Thermal resistance junction-case	0.32	$^\circ\text{C}/\text{W}$
$R_{thj-amb}$	Thermal resistance junction-ambient	50	$^\circ\text{C}/\text{W}$

Table 3. Avalanche characteristics

Symbol	Parameter	Value	Unit
I_{AR}	Avalanche current, repetitive or not repetitive (pulse width limited by T_{jmax})	7.5	A
E_{AS}	Single pulse avalanche energy (starting $T_j = 25\text{ }^\circ\text{C}$, $I_D = I_{AR}$, $V_{DD} = 50\text{ V}$)	1100	mJ

2 Electrical characteristics

($T_C = 25\text{ °C}$ unless otherwise specified)

Table 4. On /off-states

Symbol	Parameter	Test conditions	Min.	Typ.	Max.	Unit
$V_{(BR)DSS}$	Drain-source breakdown voltage	$V_{GS} = 0\text{ V}, I_D = 1\text{ mA}$	600			V
I_{DSS}	Zero-gate voltage drain current	$V_{GS} = 0\text{ V}, V_{DS} = 600\text{ V}$			1	μA
		$V_{GS} = 0\text{ V}, V_{DS} = 600\text{ V}, T_C = 125\text{ °C}^{(1)}$			100	
I_{GSS}	Gate-body leakage current	$V_{DS} = 0\text{ V}, V_{GS} = \pm 25\text{ V}$			± 5	μA
$V_{GS(th)}$	Gate threshold voltage	$V_{DS} = V_{GS}, I_D = 250\text{ }\mu\text{A}$	3.25	4	4.75	V
$R_{DS(on)}$	Static drain-source on-resistance	$V_{GS} = 10\text{ V}, I_D = 31.5\text{ A}$		35	41	$\text{m}\Omega$

1. Defined by design, not subject to production test.

Table 5. Dynamic

Symbol	Parameter	Test conditions	Min.	Typ.	Max.	Unit
C_{iss}	Input capacitance	$V_{GS} = 0\text{ V}, V_{DS} = 100\text{ V}, f = 1\text{ MHz}$	-	4360	-	pF
C_{oss}	Output capacitance		-	235	-	pF
C_{rss}	Reverse transfer capacitance		-	13	-	pF
$C_{oss\text{ eq.}}^{(1)}$	Equivalent output capacitance	$V_{GS} = 0\text{ V}, V_{DS} = 0\text{ to }480\text{ V}$	-	713	-	pF
R_G	Intrinsic gate resistance	$f = 1\text{ MHz}$ open drain	-	1.6	-	Ω
Q_g	Total gate charge	$V_{DD} = 480\text{ V}, I_D = 63\text{ A},$ $V_{GS} = 0\text{ to }10\text{ V}$ (see Figure 14. Test circuit for gate charge behavior)	-	106	-	nC
Q_{gs}	Gate-source charge		-	29	-	nC
Q_{gd}	Gate-drain charge		-	51	-	nC

1. $C_{oss\text{ eq.}}$ is defined as a constant equivalent capacitance giving the same charging time as C_{oss} when V_{DS} increases from 0 to 80% V_{DSS} .

Table 6. Switching times

Symbol	Parameter	Test conditions	Min.	Typ.	Max.	Unit
$t_{d(on)}$	Turn-on delay time	$V_{DD} = 300\text{ V}, I_D = 30\text{ A},$ $R_G = 4.7\text{ }\Omega, V_{GS} = 10\text{ V}$ (see Figure 13. Test circuit for resistive load switching times and Figure 18. Switching time waveform)	-	42	-	ns
t_r	Rise time		-	28	-	ns
$t_{d(off)}$	Turn-off delay time		-	130	-	ns
t_f	Fall time		-	8	-	ns

Table 7. Source-drain diode

Symbol	Parameter	Test conditions	Min.	Typ.	Max.	Unit
I_{SD}	Source-drain current		-		63	A
$I_{SDM}^{(1)}$	Source-drain current (pulsed)		-		252	A
$V_{SD}^{(2)}$	Forward on voltage	$V_{GS} = 0\text{ V}$, $I_{SD} = 63\text{ A}$	-		1.6	V
t_{rr}	Reverse recovery time	$I_{SD} = 63\text{ A}$, $di/dt = 100\text{ A}/\mu\text{s}$,	-	308		ns
Q_{rr}	Reverse recovery charge	$V_{DD} = 60\text{ V}$ (see Figure 15. Test circuit for inductive load switching and diode recovery times)	-	4.3		μC
I_{RRM}	Reverse recovery current		-	26		A
t_{rr}	Reverse recovery time	$I_{SD} = 63\text{ A}$, $di/dt = 100\text{ A}/\mu\text{s}$,	-	504		ns
Q_{rr}	Reverse recovery charge	$V_{DD} = 60\text{ V}$, $T_j = 150\text{ }^\circ\text{C}$ (see Figure 15. Test circuit for inductive load switching and diode recovery times)	-	10.8		μC
I_{RRM}	Reverse recovery current		-	38		A

1. Pulse width is limited by safe operating area.
2. Pulse test: pulse duration = 300 μs , duty cycle 1.5%.

2.1 Electrical characteristics (curves)

Figure 1. Safe operating area

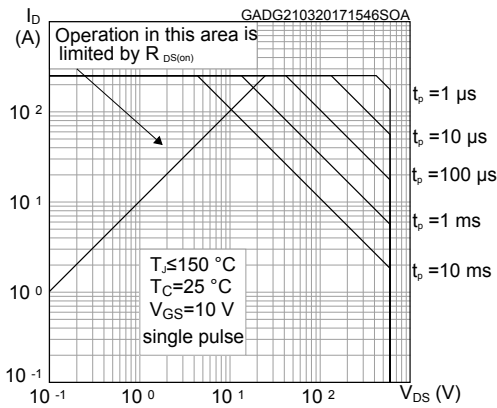

Figure 2. Thermal impedance

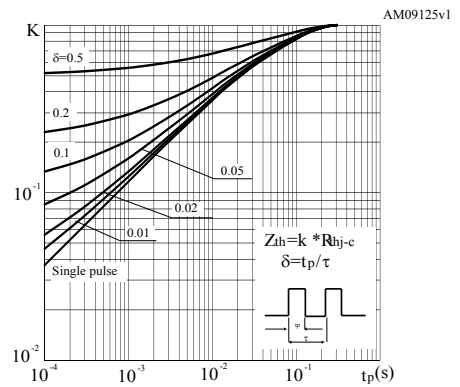

Figure 3. Output characteristics

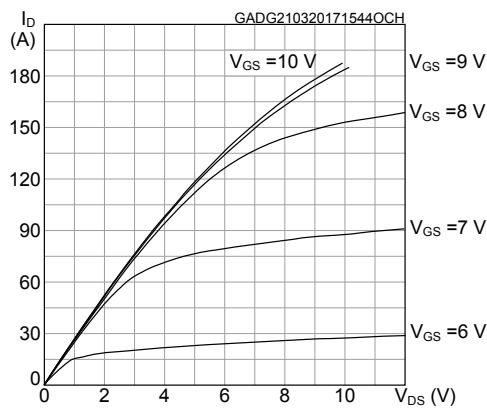

Figure 4. Transfer characteristics

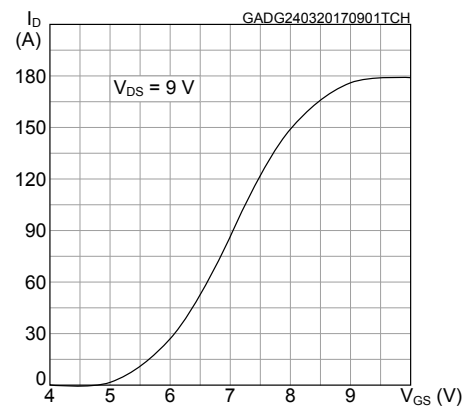

Figure 5. Gate charge vs gate-source voltage

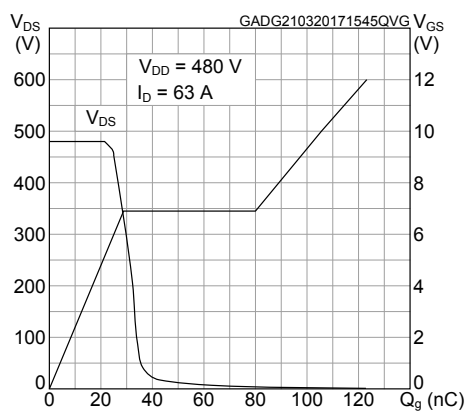

Figure 6. Static drain-source on-resistance

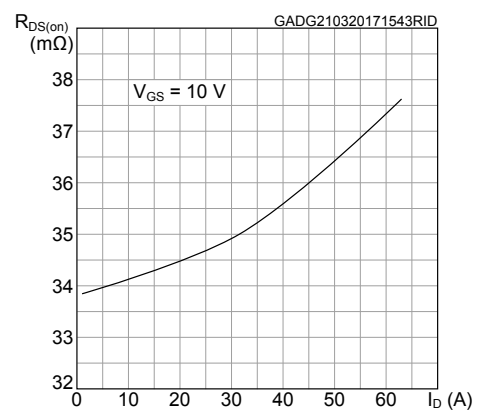

Figure 7. Capacitance variations

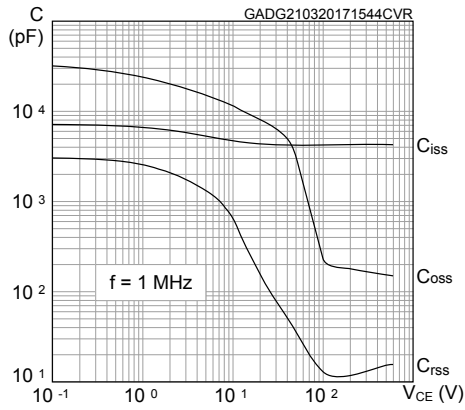

Figure 8. Normalized gate threshold vs. temperature

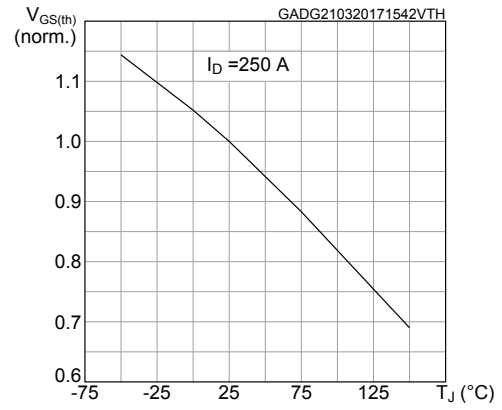

Figure 9. Normalized on-resistance vs. temperature

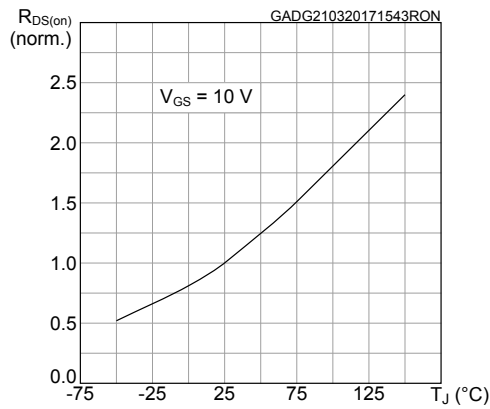

Figure 10. Normalized $V_{(BR)DSS}$ vs. temperature

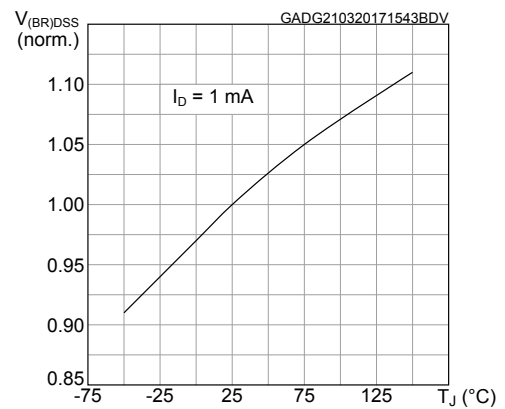

Figure 11. Output capacitance stored energy

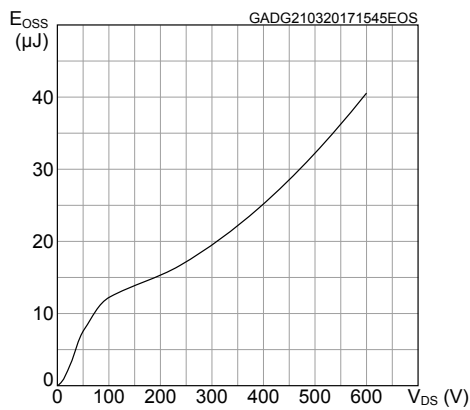
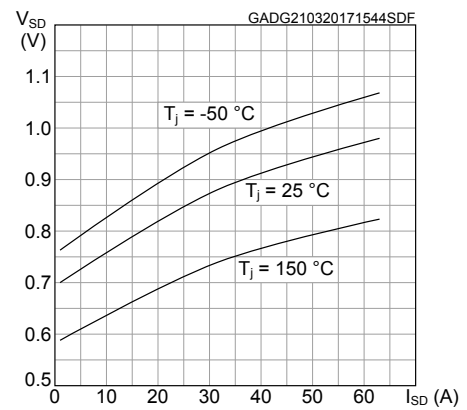
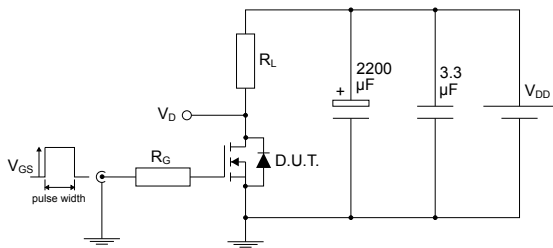

Figure 12. Source-drain diode forward characteristics



3 Test circuits

Figure 13. Test circuit for resistive load switching times

AM01468v1

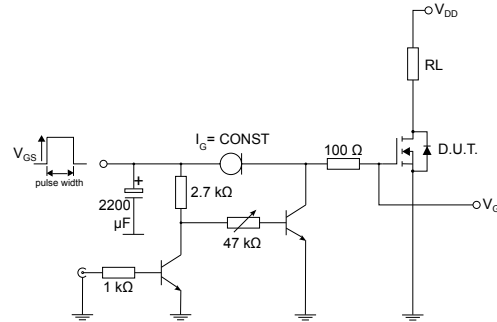
Figure 14. Test circuit for gate charge behavior

AM01469v10

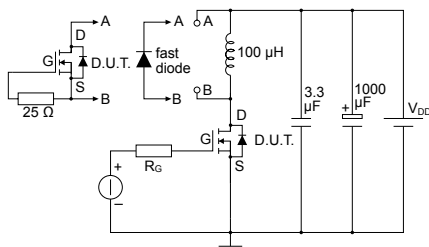
Figure 15. Test circuit for inductive load switching and diode recovery times

AM01470v1

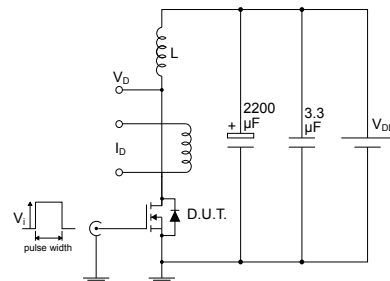
Figure 16. Unclamped inductive load test circuit

AM01471v1

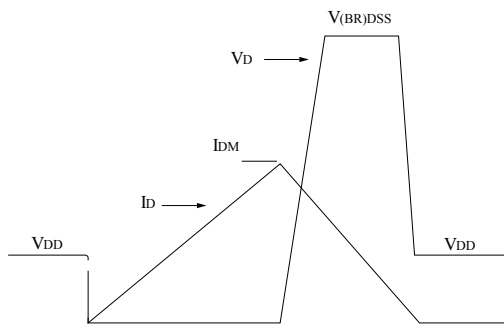
Figure 17. Unclamped inductive waveform

AM01472v1

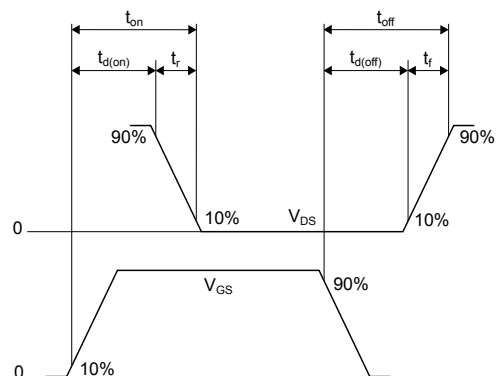
Figure 18. Switching time waveform

AM01473v1

4 Package information

In order to meet environmental requirements, ST offers these devices in different grades of **ECOPACK®** packages, depending on their level of environmental compliance. ECOPACK® specifications, grade definitions and product status are available at: www.st.com. ECOPACK® is an ST trademark.

4.1 TO-247 long leads package information

Figure 19. TO-247 long leads package outline

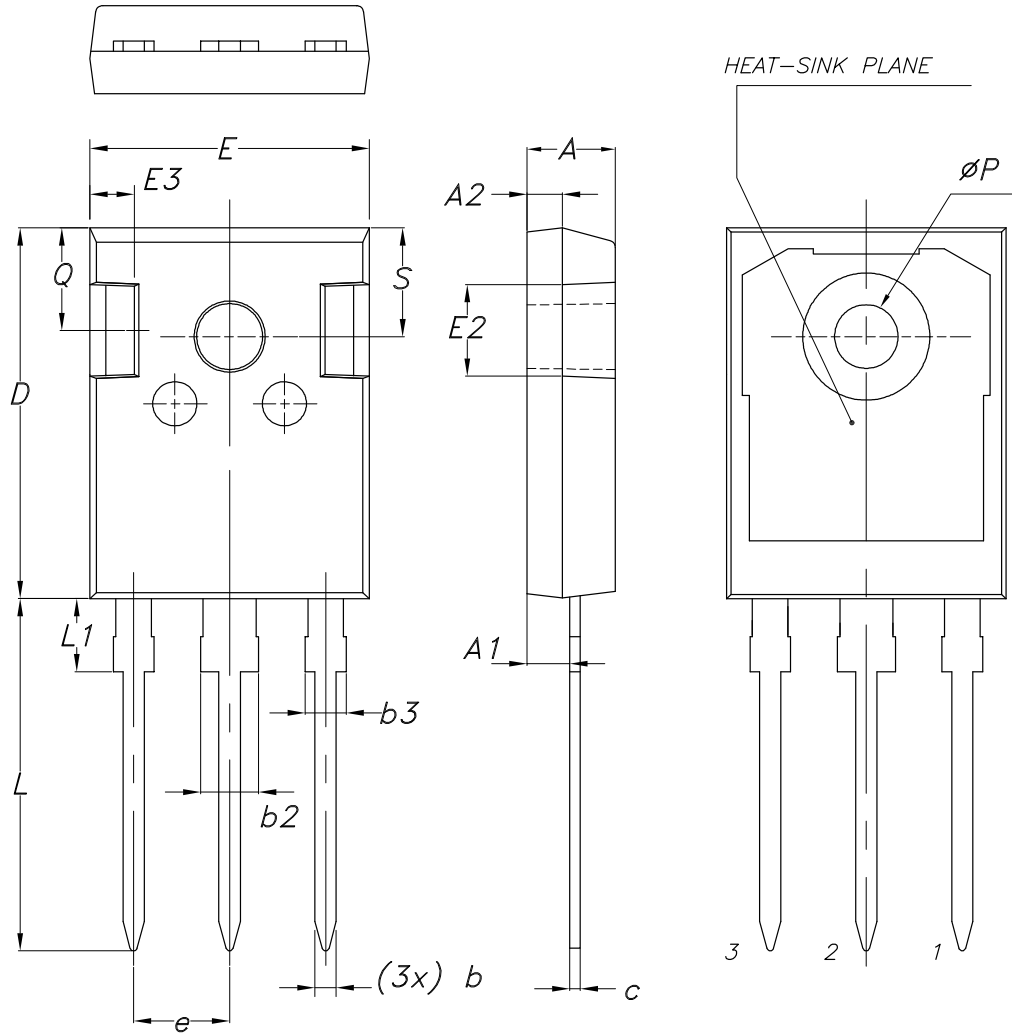

8463846_2_F

Table 8. TO-247 long leads package mechanical data

Dim.	mm		
	Min.	Typ.	Max.
A	4.90	5.00	5.10
A1	2.31	2.41	2.51
A2	1.90	2.00	2.10
b	1.16		1.26
b2			3.25
b3			2.25
c	0.59		0.66
D	20.90	21.00	21.10
E	15.70	15.80	15.90
E2	4.90	5.00	5.10
E3	2.40	2.50	2.60
e	5.34	5.44	5.54
L	19.80	19.92	20.10
L1			4.30
P	3.50	3.60	3.70
Q	5.60		6.00
S	6.05	6.15	6.25

Revision history

Table 9. Document revision history

Date	Revision	Changes
03-Apr-2017	1	First release.
05-Nov-2018	2	<p>Removed maturity status indication from cover page. The document status is production data.</p> <p>Modified Table 1. Absolute maximum ratings, Table 5. Dynamic and Table 7. Source-drain diode</p> <p>Modified Figure 1. Safe operating area, Figure 3. Output characteristics, Figure 4. Transfer characteristics, Figure 5. Gate charge vs gate-source voltage, Figure 6. Static drain-source on-resistance, Figure 7. Capacitance variations, Figure 8. Normalized gate threshold vs. temperature, Figure 9. Normalized on-resistance vs. temperature, Figure 10. Normalized $V_{(BR)DSS}$ vs. temperature and Figure 12. Source-drain diode forward characteristics.</p> <p>Minor text changes.</p>

Contents

1	Electrical ratings	2
2	Electrical characteristics	3
2.1	Electrical characteristics (curves)	5
3	Test circuits	7
4	Package information	8
4.1	TO-247 long leads package information	8
	Revision history	11

IMPORTANT NOTICE – PLEASE READ CAREFULLY

STMicroelectronics NV and its subsidiaries (“ST”) reserve the right to make changes, corrections, enhancements, modifications, and improvements to ST products and/or to this document at any time without notice. Purchasers should obtain the latest relevant information on ST products before placing orders. ST products are sold pursuant to ST’s terms and conditions of sale in place at the time of order acknowledgement.

Purchasers are solely responsible for the choice, selection, and use of ST products and ST assumes no liability for application assistance or the design of Purchasers’ products.

No license, express or implied, to any intellectual property right is granted by ST herein.

Resale of ST products with provisions different from the information set forth herein shall void any warranty granted by ST for such product.

ST and the ST logo are trademarks of ST. All other product or service names are the property of their respective owners.

Information in this document supersedes and replaces information previously supplied in any prior versions of this document.

© 2018 STMicroelectronics – All rights reserved