

# TSM230N06PQ56

## 60V N-Channel Power MOSFET

### PDFN56

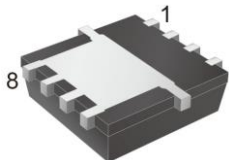

### Pin Definition:

- |           |          |
|-----------|----------|
| 1. Source | 8. Drain |
| 2. Source | 7. Drain |
| 3. Source | 6. Drain |
| 4. Gate   | 5. Drain |

### Note:

MSL 1 (Moisture Sensitivity Level) per J-STD-020

### Key Parameter Performance

Parameter	Value	Unit
$V_{DS}$	60	V
$R_{DS(on)}$ (max)	$V_{GS} = 10V$	23
	$V_{GS} = 4.5V$	28
$Q_g$	28	nC

### Ordering Information

Part No.	Package	Packing
TSM230N06PQ56 RLG	PDFN56	2.5kpcs / 13" Reel

- Note: Halogen-free according to IEC 61249-2-21 definition

### Block Diagram

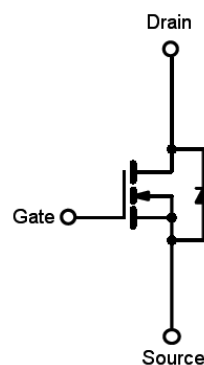

N-Channel MOSFET

### Absolute Maximum Ratings ( $T_c = 25^\circ\text{C}$ unless otherwise noted)

Parameter	Symbol	Limit	Unit
Drain-Source Voltage	$V_{DS}$	60	V
Gate-Source Voltage	$V_{GS}$	$\pm 20$	V
Continuous Drain Current	$I_D$	$T_c = 25^\circ\text{C}$	44
		$T_c = 100^\circ\text{C}$	28
Pulsed Drain Current <sup>(Note 1)</sup>	$I_{DM}$	176	A
Single Pulse Avalanche Energy <sup>(Note 2)</sup>	$E_{AS}$	42	mJ
Power Dissipation @ $T_c = 25^\circ\text{C}$	$P_D$	83	W
Operating Junction Temperature	$T_J$	-55 to +150	$^\circ\text{C}$
Storage Temperature Range	$T_{STG}$	-55 to +150	$^\circ\text{C}$

### Thermal Performance

Parameter	Symbol	Limit	Unit
Thermal Resistance - Junction to Case	$R_{\theta JC}$	1.5	$^\circ\text{C}/\text{W}$
Thermal Resistance - Junction to Ambient	$R_{\theta JA}$	62	

### Electrical Specifications ( $T_C = 25^\circ\text{C}$ unless otherwise noted)

Parameter	Conditions	Symbol	Min	Typ	Max	Unit
<b>Static</b>						
Drain-Source Breakdown Voltage	$V_{GS} = 0V, I_D = 250\mu A$	$BV_{DSS}$	60	--	--	V
Drain-Source On-State Resistance	$V_{GS} = 10V, I_D = 20A$	$R_{DS(on)}$	--	20	23	m $\Omega$
	$V_{GS} = 4.5V, I_D = 12A$		--	23	28	
Gate Threshold Voltage	$V_{DS} = V_{GS}, I_D = 250\mu A$	$V_{GS(TH)}$	1.2	1.8	2.5	V
Zero Gate Voltage Drain Current	$V_{DS} = 60V, V_{GS} = 0V$	$I_{DSS}$	--	--	1	$\mu A$
	$V_{DS} = 48V, T_J = 125^\circ\text{C}$		--	--	10	
Gate Body Leakage	$V_{GS} = \pm 20V, V_{DS} = 0V$	$I_{GSS}$	--	--	$\pm 100$	nA
Forward Transconductance <sup>(Note 3)</sup>	$V_{DS} = 10V, I_D = 10A$	$g_{fs}$	--	9	--	S
<b>Dynamic</b>						
Total Gate Charge <sup>(Note 3,4)</sup>	$V_{DS} = 30V, I_D = 15A,$ $V_{GS} = 10V$	$Q_g$	--	28	--	nC
Gate-Source Charge <sup>(Note 3,4)</sup>		$Q_{GS}$	--	3.5	--	
Gate-Drain Charge <sup>(Note 3,4)</sup>		$Q_{GD}$	--	6.5	--	
Input Capacitance	$V_{DS} = 20V, V_{GS} = 0V,$ $f = 1.0\text{MHz}$	$C_{iss}$	--	1680	--	pF
Output Capacitance		$C_{oss}$	--	115	--	
Reverse Transfer Capacitance		$C_{rss}$	--	85	--	
<b>Switching</b>						
Turn-On Delay Time <sup>(Note 3,4)</sup>	$V_{DD} = 30V, I_D = 1A,$ $V_{GS} = 10V, R_G = 6\Omega$	$t_{d(on)}$	--	7.2	--	ns
Turn-On Rise Time <sup>(Note 3,4)</sup>		$t_r$	--	38	--	
Turn-Off Delay Time <sup>(Note 3,4)</sup>		$t_{d(off)}$	--	34	--	
Turn-Off Fall Time <sup>(Note 3,4)</sup>		$t_f$	--	8.2	--	
<b>Source-Drain Diode Ratings and Characteristic</b>						
Maximum Continuous Drain-Source Diode Forward Current	Integral reverse diode in the MOSFET	$I_S$	--	--	44	A
Maximum Pulse Drain-Source Diode Forward Current		$I_{SM}$	--	--	176	A
Diode-Source Forward Voltage	$V_{GS} = 0V, I_S = 1A$	$V_{SD}$	--	--	1	V
Reverse Recovery Time <sup>(Note 3)</sup>	$V_{GS} = 0V, I_S = 1A$	$t_{rr}$	--	19.6	--	ns
Reverse Recovery Charge <sup>(Note 3)</sup>	$di_F/dt = 100A/\mu s$	$Q_{rr}$	--	14.2	--	nC

#### Note:

- Pulse width limited by safe operating area
- $L = 0.1\text{mH}, I_{AS} = 29A, V_{DD} = 25V, R_G = 25\Omega,$  Starting  $T_J = 25^\circ\text{C}$
- Pulse test: pulse width  $\leq 300\mu s,$  duty cycle  $\leq 2\%$
- Switching time is essentially independent of operating temperature.

### Electrical Characteristics Curve

**Continuous Drain Current vs.  $T_C$**

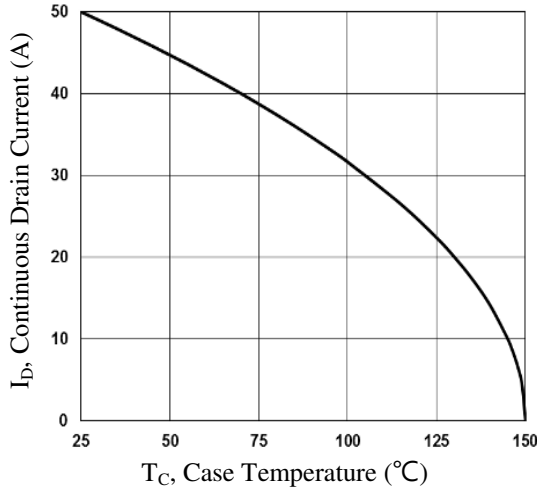

**$R_{DS(on)}$  vs. Continuous Drain Current**

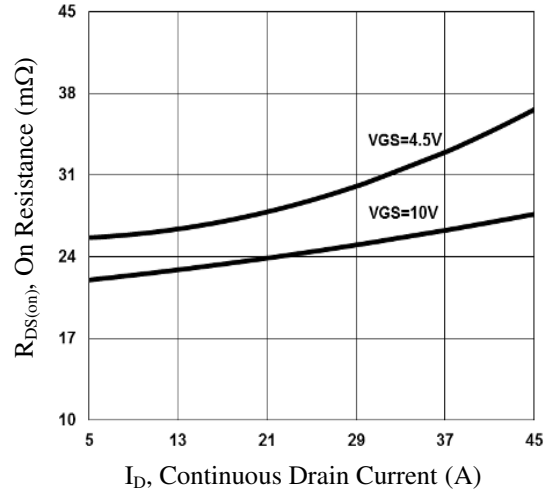

**Capacitance**

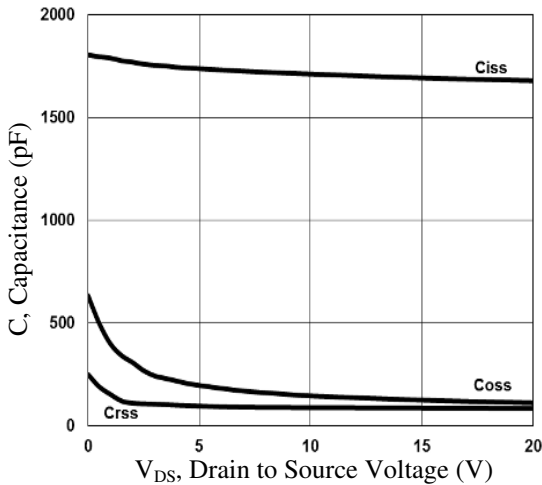

**Gate Charge**

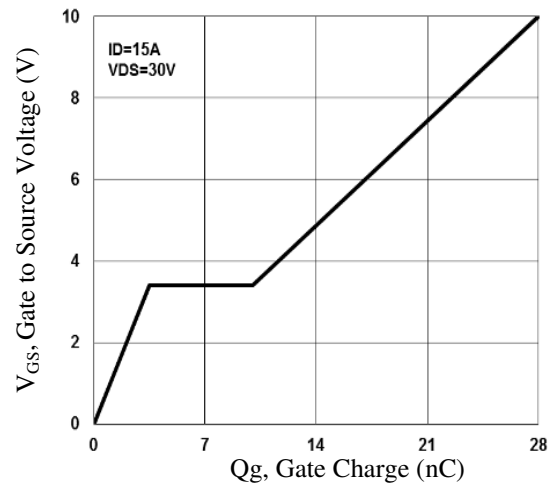

**On-Resistance vs. Junction Temperature**

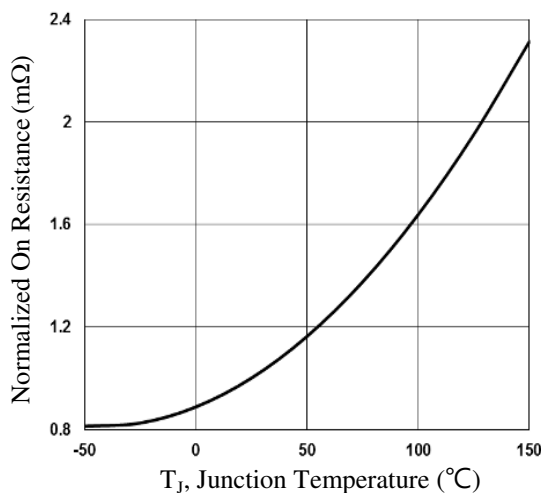

**Threshold Voltage vs. Junction Temperature**

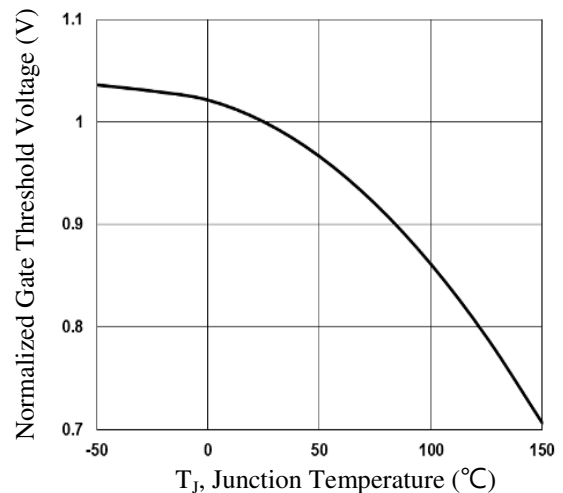

### Electrical Characteristics Curve

**Normalized Thermal Transient Impedance Curve**

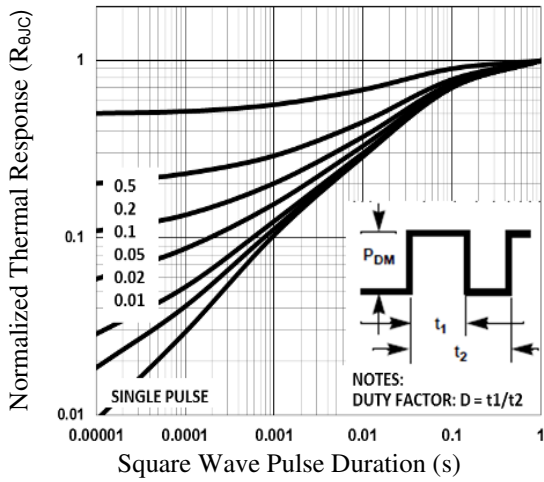

**Maximum Safe Operating Area**

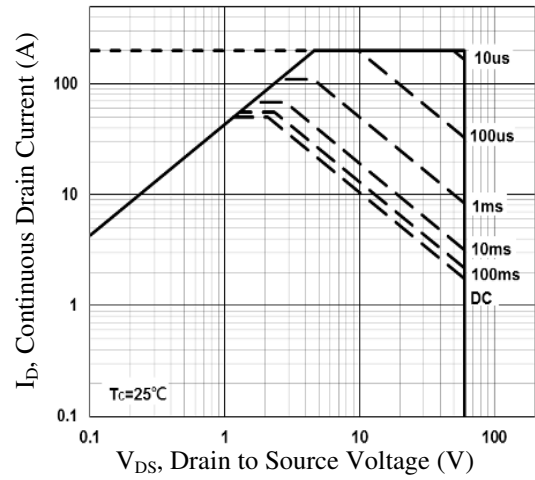

### PDFN56 Mechanical Drawing

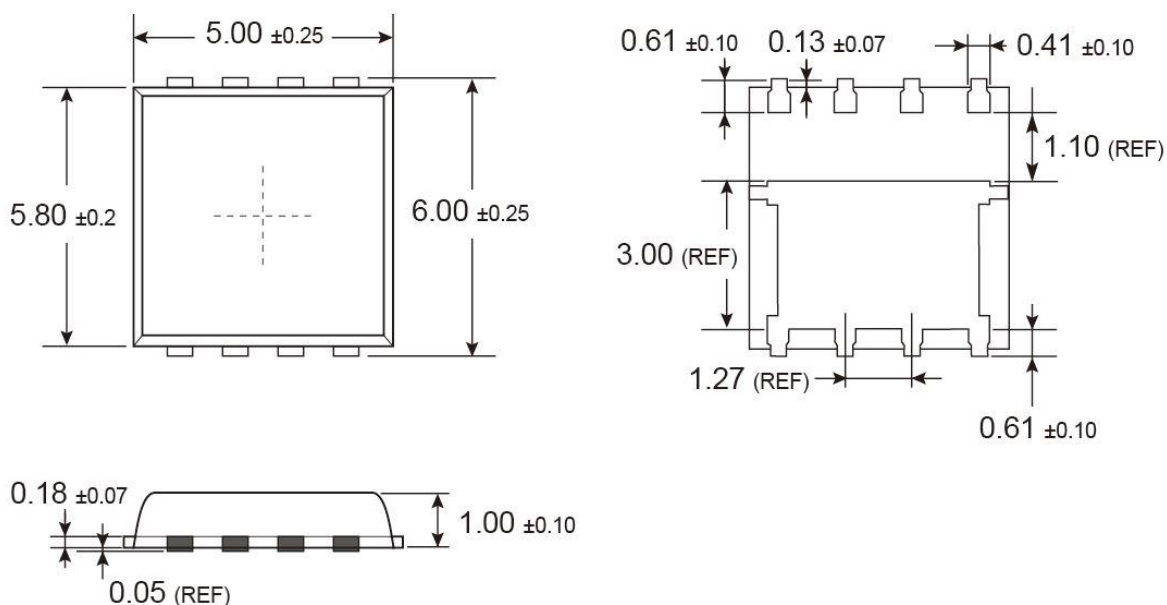

Unit: Millimeters

### Marking Diagram

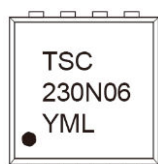

- Y** = Year Code
- M** = Month Code for Halogen Free Product  
(**O**=Jan, **P**=Feb, **Q**=Mar, **R**=Apr, **S**=May, **T**=Jun, **U**=Jul, **V**=Aug, **W**=Sep, **X**=Oct, **Y**=Nov, **Z**=Dec)
- L** = Lot Code

### Notice

Specifications of the products displayed herein are subject to change without notice. TSC or anyone on its behalf, assumes no responsibility or liability for any errors or inaccuracies.

Information contained herein is intended to provide a product description only. No license, express or implied, to any intellectual property rights is granted by this document. Except as provided in TSC's terms and conditions of sale for such products, TSC assumes no liability whatsoever, and disclaims any express or implied warranty, relating to sale and/or use of TSC products including liability or warranties relating to fitness for a particular purpose, merchantability, or infringement of any patent, copyright, or other intellectual property right.

The products shown herein are not designed for use in medical, life-saving, or life-sustaining applications. Customers using or selling these products for use in such applications do so at their own risk and agree to fully indemnify TSC for any damages resulting from such improper use or sale.