

## N-Channel 200-V (D-S) MOSFET

PRODUCT SUMMARY		
$V_{DS}$ (V)	$R_{DS(on)}$ ( $\Omega$ )	$I_D$ (A)
200	0.240 at $V_{GS} = 10$ V	2.2
	0.260 at $V_{GS} = 6.0$ V	2.1

### FEATURES

- Halogen-free According to IEC 61249-2-21 Definition
- TrenchFET® Power MOSFET
- PWM Optimized for Low  $Q_g$  and Low  $R_g$
- Compliant to RoHS Directive 2002/95/EC



**RoHS**  
COMPLIANT  
HALOGEN  
**FREE**  
Available

### APPLICATIONS

- Primary Side Switch

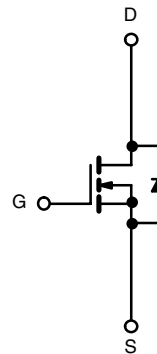
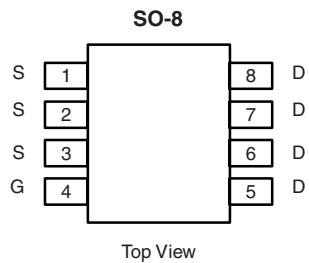

Ordering Information: Si4464DY-T1-E3 (Lead (Pb)-free)  
Si4464DY-T1-GE3 (Lead (Pb)-free and Halogen-free)

N-Channel MOSFET

ABSOLUTE MAXIMUM RATINGS $T_A = 25$ °C, unless otherwise noted					
Parameter	Symbol	10 s	Steady State	Unit	
Drain-Source Voltage	$V_{DS}$	200		V	
Gate-Source Voltage	$V_{GS}$	$\pm 20$			
Continuous Drain Current ( $T_J = 150$ °C) <sup>a</sup>	$I_D$	$T_A = 25$ °C	2.2	1.7	A
		$T_A = 70$ °C	1.7	1.3	
Pulsed Drain Current	$I_{DM}$	8			
Single Avalanche Current	$I_{AS}$	3			
Single Avalanche Energy	$E_{AS}$	0.45		mJ	
Continuous Source Current (Diode Conduction) <sup>a</sup>	$I_S$	$T_A = 25$ °C	2.1	1.2	A
		$T_A = 70$ °C	1.6	0.9	
Maximum Power Dissipation <sup>a</sup>	$P_D$	- 55 to 150		°C	

THERMAL RESISTANCE RATINGS					
Parameter	Symbol	Typical	Maximum	Unit	
Maximum Junction-to-Ambient <sup>a</sup>	$R_{thJA}$	$t \leq 10$ s	37	50	°C/W
		Steady State	68	85	
Maximum Junction-to-Foot (Drain)	$R_{thJF}$	17	21		

Notes:

a. Surface Mounted on 1" x 1" FR4 board.



SPECIFICATIONS $T_J = 25\text{ }^\circ\text{C}$ , unless otherwise noted						
Parameter	Symbol	Test Conditions	Min.	Typ.	Max.	Unit
<b>Static</b>						
Gate Threshold Voltage	$V_{GS(th)}$	$V_{DS} = V_{GS}, I_D = 250\text{ }\mu\text{A}$	2.0		4	V
Gate-Body Leakage	$I_{GSS}$	$V_{DS} = 0\text{ V}, V_{GS} = \pm 20\text{ V}$			$\pm 100$	nA
Zero Gate Voltage Drain Current	$I_{DSS}$	$V_{DS} = 200\text{ V}, V_{GS} = 0\text{ V}$			1	$\mu\text{A}$
		$V_{DS} = 200\text{ V}, V_{GS} = 0\text{ V}, T_J = 55\text{ }^\circ\text{C}$			5	
On-State Drain Current <sup>a</sup>	$I_{D(on)}$	$V_{DS} \geq 5\text{ V}, V_{GS} = 10\text{ V}$	8			A
Drain-Source On-State Resistance <sup>a</sup>	$R_{DS(on)}$	$V_{GS} = 10\text{ V}, I_D = 2.2\text{ A}$		0.195	0.240	$\Omega$
		$V_{GS} = 6.0\text{ V}, I_D = 2.1\text{ A}$		0.210	0.260	
Forward Transconductance <sup>a</sup>	$g_{fs}$	$V_{DS} = 15\text{ V}, I_D = 2.2\text{ A}$		8.0		S
Diode Forward Voltage <sup>a</sup>	$V_{SD}$	$I_S = 2.1\text{ A}, V_{GS} = 0\text{ V}$		0.8	1.2	V
<b>Dynamic<sup>b</sup></b>						
Total Gate Charge	$Q_g$	$V_{DS} = 100\text{ V}, V_{GS} = 10\text{ V}, I_D = 2.2\text{ A}$		12	18	nC
Gate-Source Charge	$Q_{gs}$			2.5		
Gate-Drain Charge	$Q_{gd}$			3.8		
Gate Resistance	$R_g$			2.5		$\Omega$
Turn-On Delay Time	$t_{d(on)}$	$V_{DD} = 100\text{ V}, R_L = 100\text{ }\Omega$ $I_D \cong 1\text{ A}, V_{GEN} = 10\text{ V}, R_g = 6\text{ }\Omega$		10	15	ns
Rise Time	$t_r$			12	20	
Turn-Off Delay Time	$t_{d(off)}$			15	25	
Fall Time	$t_f$			15	25	
Source-Drain Reverse Recovery Time	$t_{rr}$	$I_F = 2.1\text{ A}, di/dt = 100\text{ A}/\mu\text{s}$		60	90	

Notes:

- a. Pulse test; pulse width  $\leq 300\text{ }\mu\text{s}$ , duty cycle  $\leq 2\%$ .
- b. Guaranteed by design, not subject to production testing.

Stresses beyond those listed under "Absolute Maximum Ratings" may cause permanent damage to the device. These are stress ratings only, and functional operation of the device at these or any other conditions beyond those indicated in the operational sections of the specifications is not implied. Exposure to absolute maximum rating conditions for extended periods may affect device reliability.

**TYPICAL CHARACTERISTICS**  $25\text{ }^\circ\text{C}$ , unless otherwise noted

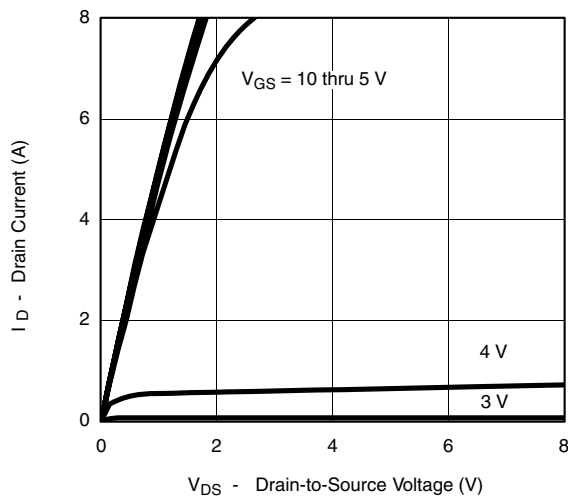

**Output Characteristics**

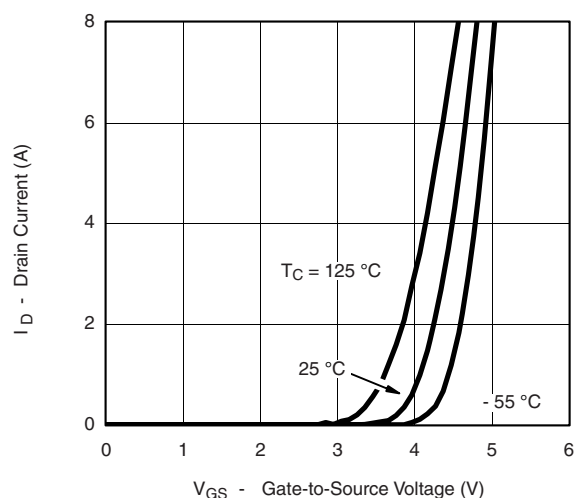

**Transfer Characteristics**

## TYPICAL CHARACTERISTICS 25 °C, unless otherwise noted

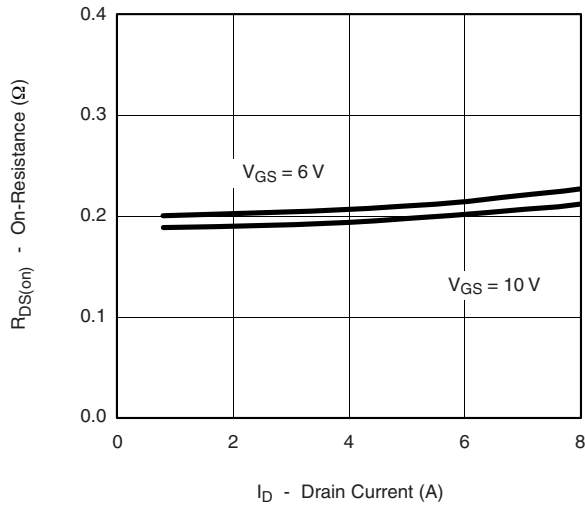

**On-Resistance vs. Drain Current**

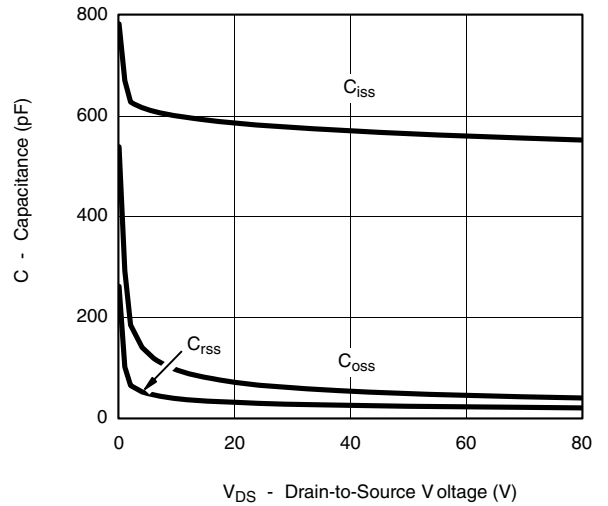

**Capacitance**

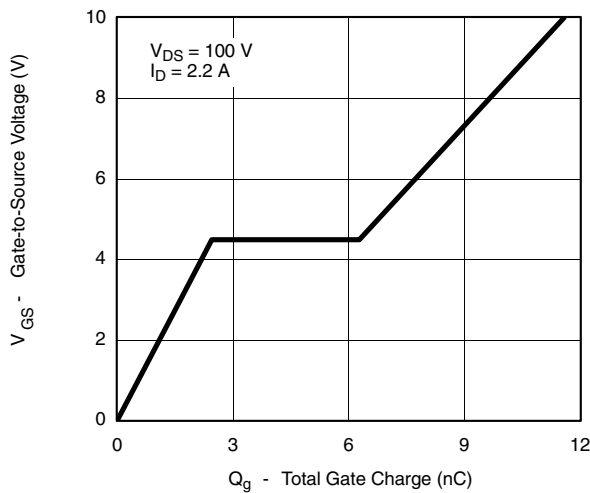

**Gate Charge**

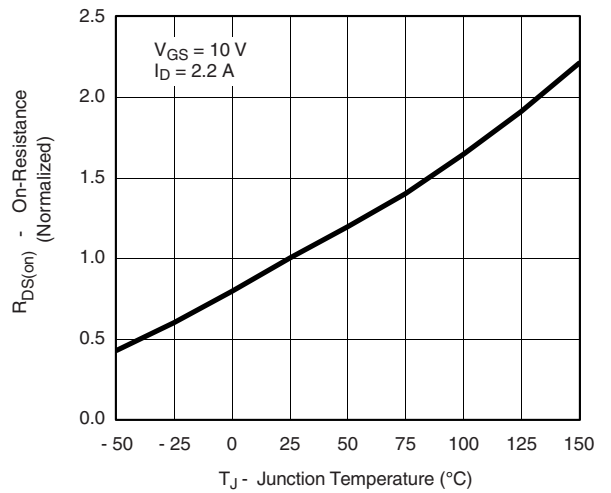

**On-Resistance vs. Junction Temperature**

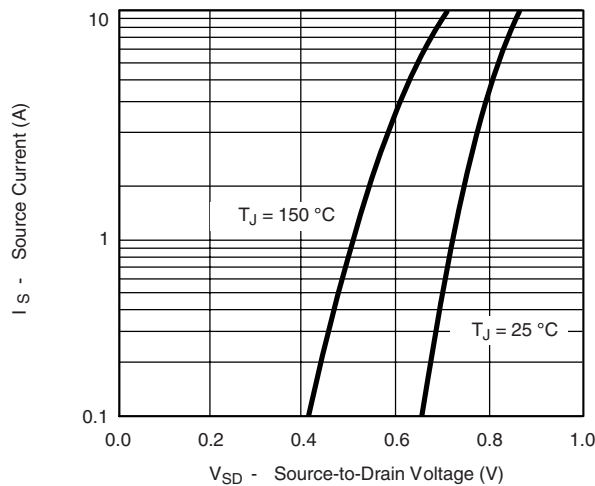

**Source-Drain Diode Forward Voltage**

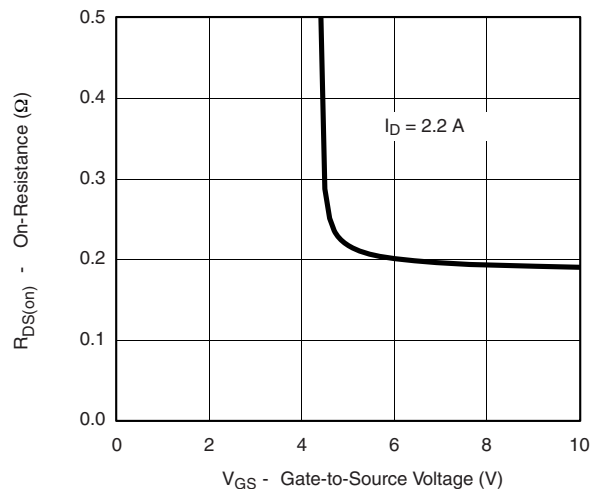

**On-Resistance vs. Gate-to-Source Voltage**

**TYPICAL CHARACTERISTICS** 25 °C, unless otherwise noted

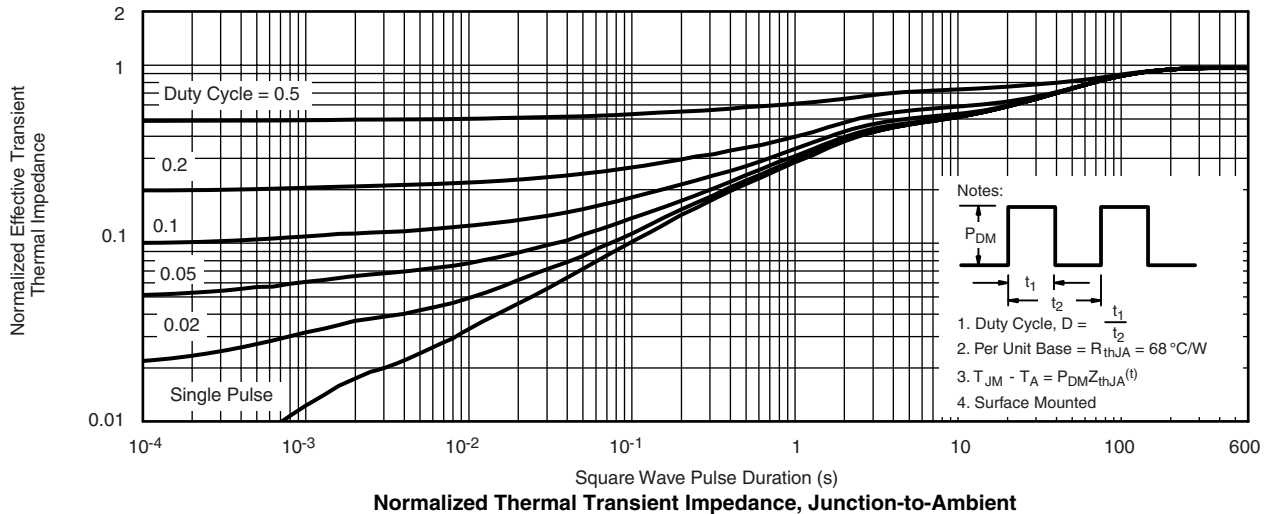
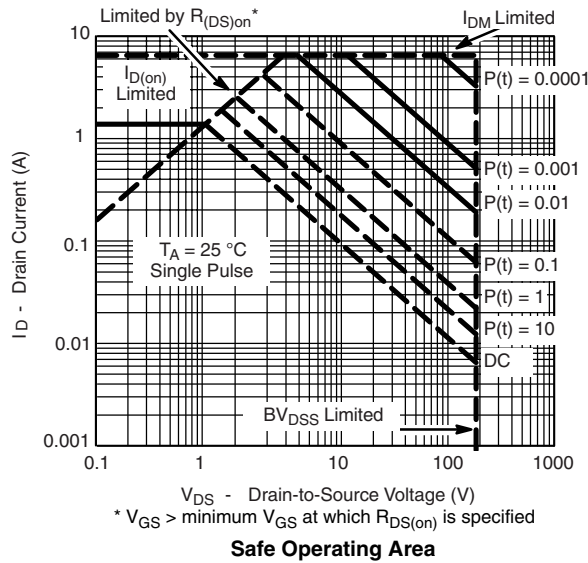
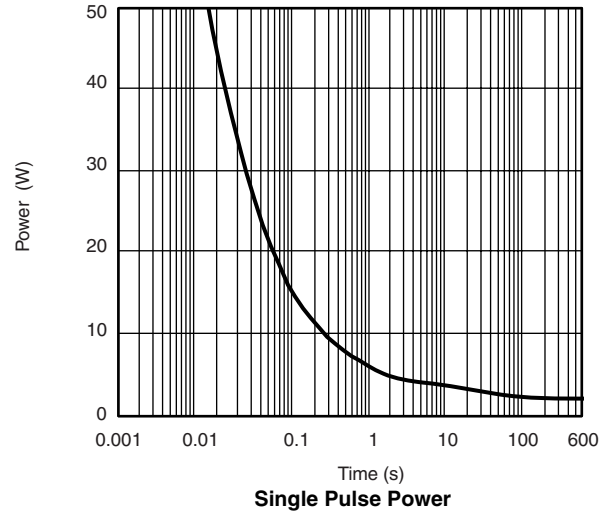
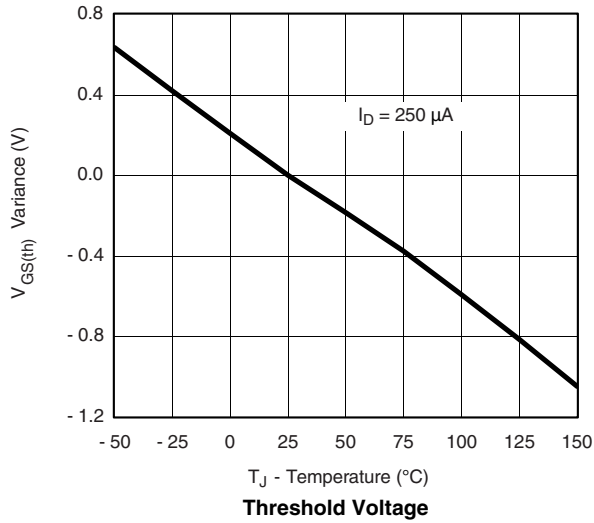



**TYPICAL CHARACTERISTICS** 25 °C, unless otherwise noted

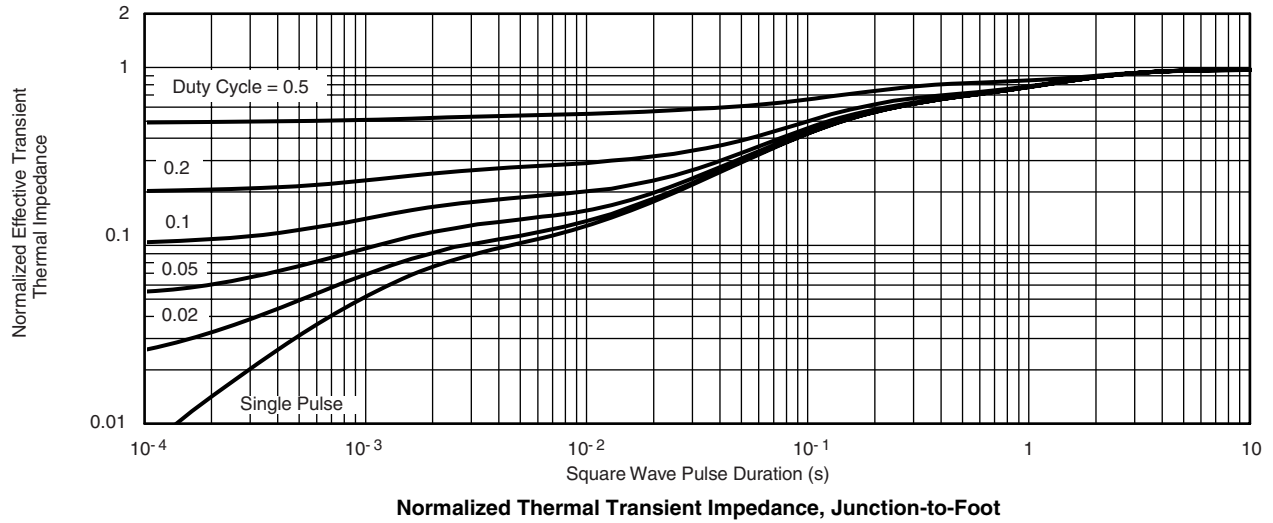

Vishay Siliconix maintains worldwide manufacturing capability. Products may be manufactured at one of several qualified locations. Reliability data for Silicon Technology and Package Reliability represent a composite of all qualified locations. For related documents such as package/tape drawings, part marking, and reliability data, see [www.vishay.com/ppg?72051](http://www.vishay.com/ppg?72051).

## SOIC (NARROW): 8-LEAD

JEDEC Part Number: MS-012

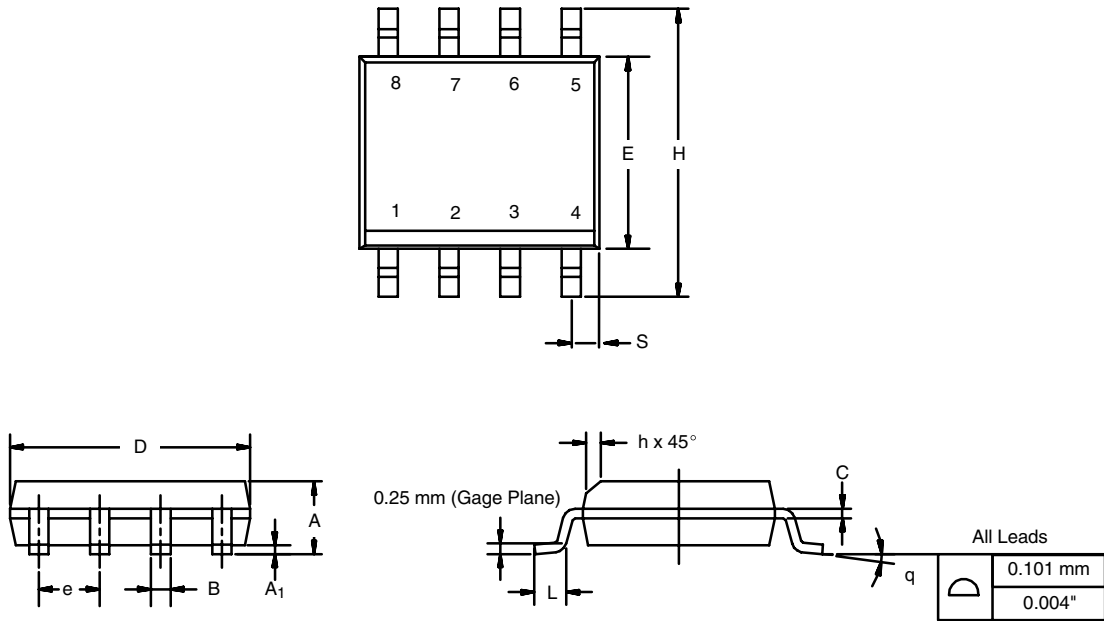

DIM	MILLIMETERS		INCHES	
	Min	Max	Min	Max
A	1.35	1.75	0.053	0.069
A <sub>1</sub>	0.10	0.20	0.004	0.008
B	0.35	0.51	0.014	0.020
C	0.19	0.25	0.0075	0.010
D	4.80	5.00	0.189	0.196
E	3.80	4.00	0.150	0.157
e	1.27 BSC		0.050 BSC	
H	5.80	6.20	0.228	0.244
h	0.25	0.50	0.010	0.020
L	0.50	0.93	0.020	0.037
q	0°	8°	0°	8°
S	0.44	0.64	0.018	0.026
ECN: C-06527-Rev. I, 11-Sep-06				
DWG: 5498				

## RECOMMENDED MINIMUM PADS FOR SO-8

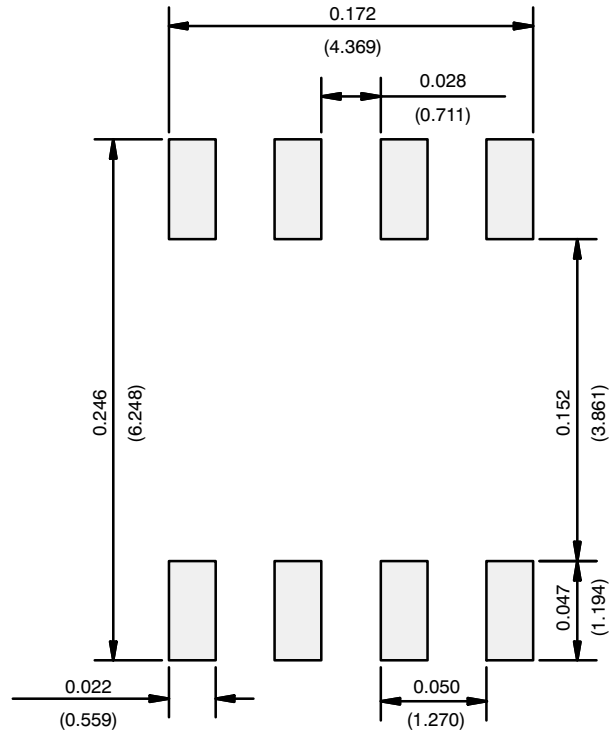

Recommended Minimum Pads  
Dimensions in Inches/(mm)

[Return to Index](#)



## **Disclaimer**

ALL PRODUCT, PRODUCT SPECIFICATIONS AND DATA ARE SUBJECT TO CHANGE WITHOUT NOTICE TO IMPROVE RELIABILITY, FUNCTION OR DESIGN OR OTHERWISE.

Vishay Intertechnology, Inc., its affiliates, agents, and employees, and all persons acting on its or their behalf (collectively, "Vishay"), disclaim any and all liability for any errors, inaccuracies or incompleteness contained in any datasheet or in any other disclosure relating to any product.

Vishay makes no warranty, representation or guarantee regarding the suitability of the products for any particular purpose or the continuing production of any product. To the maximum extent permitted by applicable law, Vishay disclaims (i) any and all liability arising out of the application or use of any product, (ii) any and all liability, including without limitation special, consequential or incidental damages, and (iii) any and all implied warranties, including warranties of fitness for particular purpose, non-infringement and merchantability.

Statements regarding the suitability of products for certain types of applications are based on Vishay's knowledge of typical requirements that are often placed on Vishay products in generic applications. Such statements are not binding statements about the suitability of products for a particular application. It is the customer's responsibility to validate that a particular product with the properties described in the product specification is suitable for use in a particular application. Parameters provided in datasheets and / or specifications may vary in different applications and performance may vary over time. All operating parameters, including typical parameters, must be validated for each customer application by the customer's technical experts. Product specifications do not expand or otherwise modify Vishay's terms and conditions of purchase, including but not limited to the warranty expressed therein.

Except as expressly indicated in writing, Vishay products are not designed for use in medical, life-saving, or life-sustaining applications or for any other application in which the failure of the Vishay product could result in personal injury or death. Customers using or selling Vishay products not expressly indicated for use in such applications do so at their own risk. Please contact authorized Vishay personnel to obtain written terms and conditions regarding products designed for such applications.

No license, express or implied, by estoppel or otherwise, to any intellectual property rights is granted by this document or by any conduct of Vishay. Product names and markings noted herein may be trademarks of their respective owners.